



BNL/PBL SBIR Phase II HTS Program for approaching 40 T

Robert Weggel, David Cline, Alper Garren, Jim Kolonko,
Ronald Scanlan

PBL

Ramesh Gupta, Mike Anerella, George Ganetis, Arup Ghosh,
Harold Kirk, Robert Palmer, Steve Plate, William Sampson,
Yuko Shiroyanagi, Peter Wanderer, Bruce Brandt

BNL

Seminar In FNAL Tech Division July 22, 2010

- Introduction to YBCO
- BNL RIA/FRIB magnet
- Muon Collider Requirements
- SBIR Program Design
- SBIR Program Progress
- Conclusion

See [NFMCC-DOC-553](#)

Introduction to YBCO

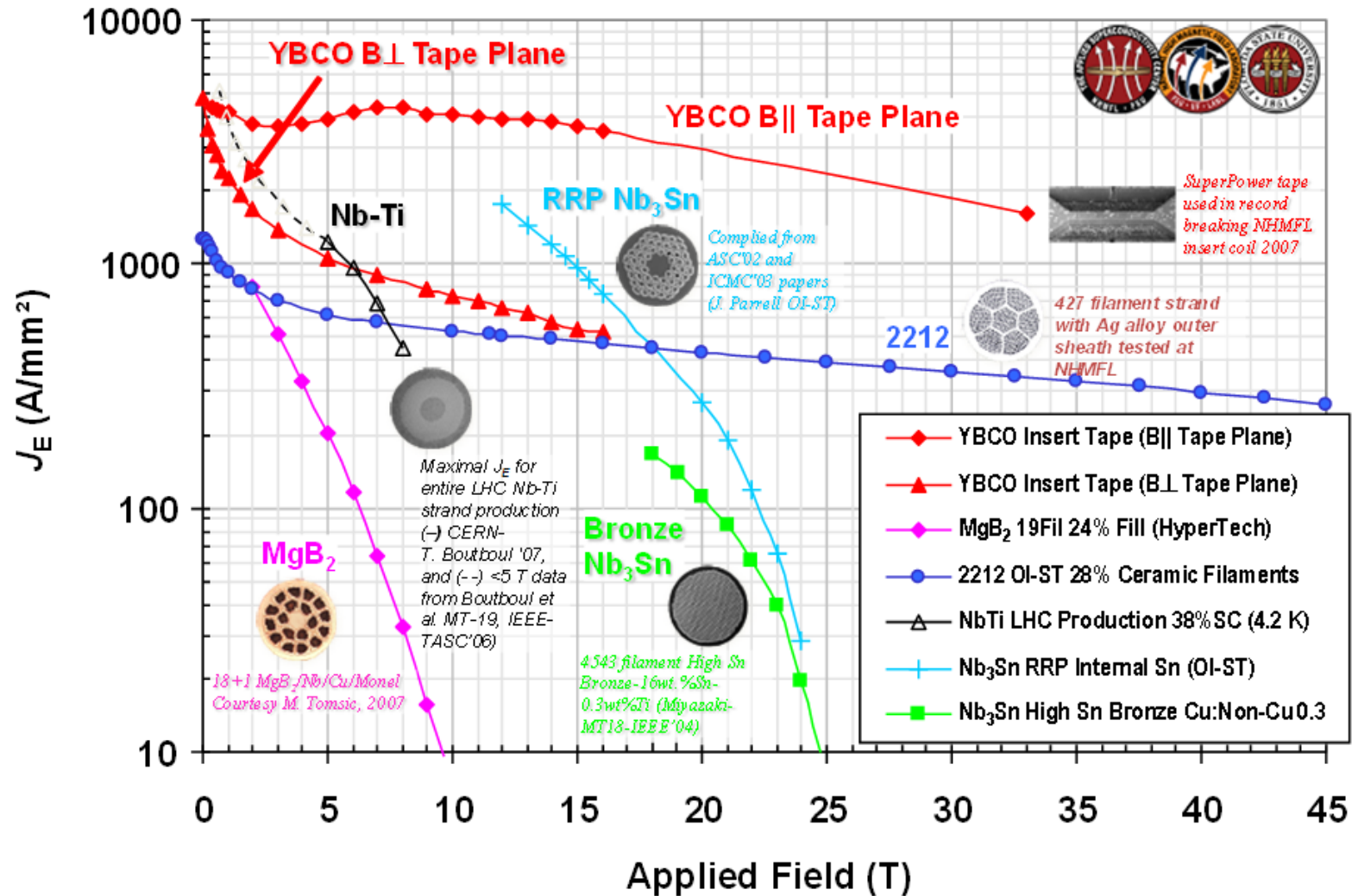

- J_c 's still very high as $B \rightarrow 40$ T
- YBCO Much better than BCCO for direction in long solenoid
- But we must include the angle effect for finite length coils

But

- YBCO comes as single super-conducting layer 4-12 mm wide
- Currents will not flow uniformly over width
- Will have extreme 'magnetization'
- NOT suitable for normal accelerator quality dipoles or quadruples

- But suitable for:
 1. Iron dominated magnets
e.g Quadruples in very high radiation environments

 2. Energy storage devices
no requirements on field details

 3. Final Cooling solenoids for Muon Collider
tracks follow field lines wherever they are

- J_c depends on angle between cable and field
but in a long solenoid the field is in the favorable direction

Expression for j vs. B & Angle

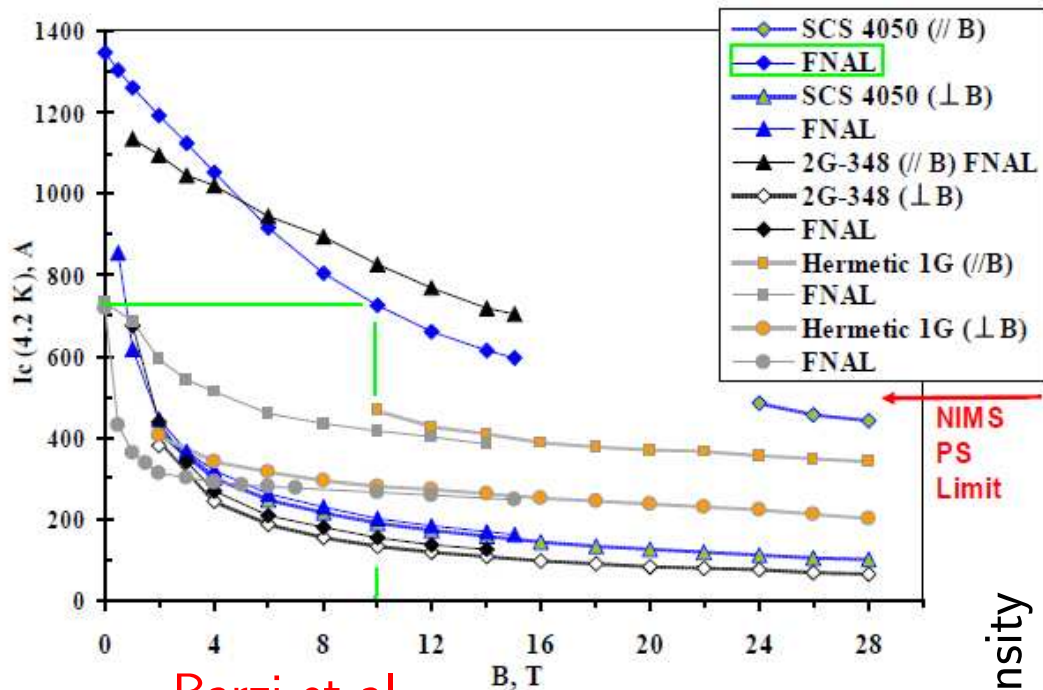

Barzi et al

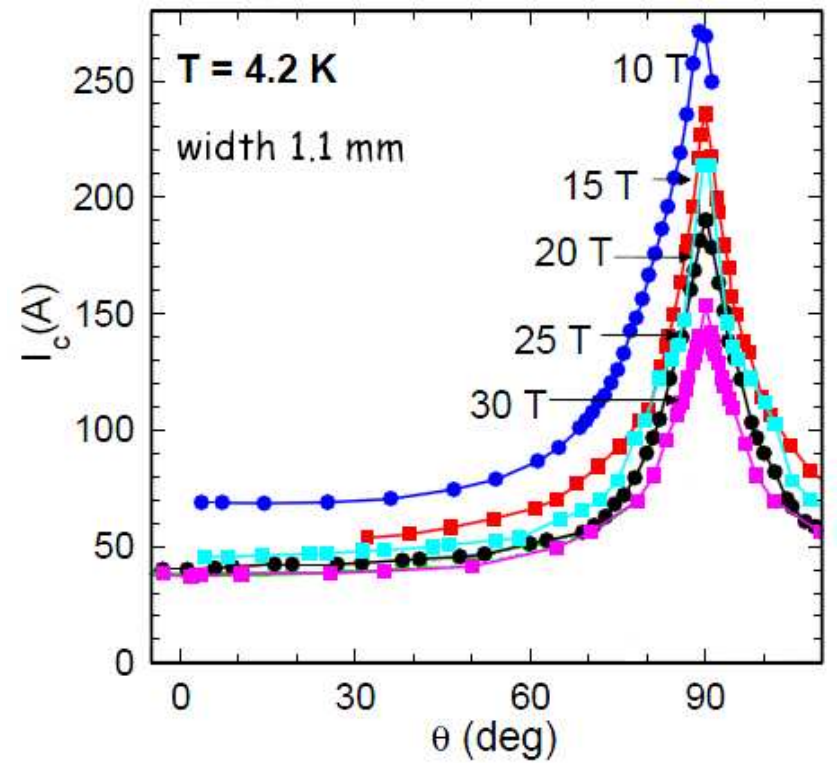

Jaroszynski et al

- 10-30 from Jaroszynski
- 0-10 from Barzi
- Fit to relative current densities:

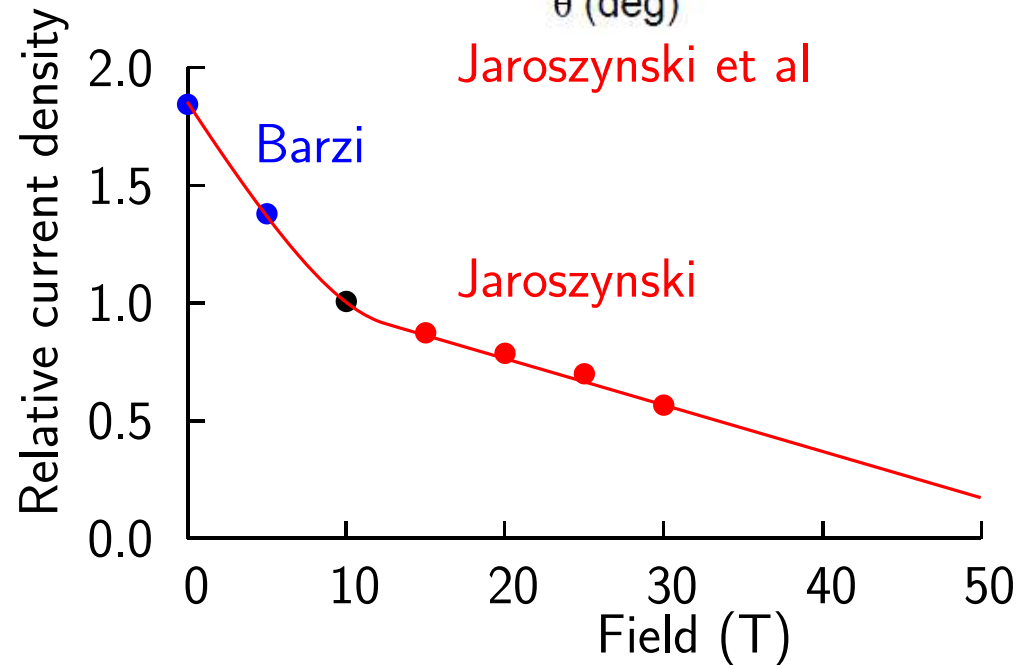

$$j_o \propto \sqrt{(1.45(1 - 0.08 B))^2 + (1.16 (1 - 0.017 B))^2}$$

Fit Angle dependence & normalize

- Fit to relative angle dependences

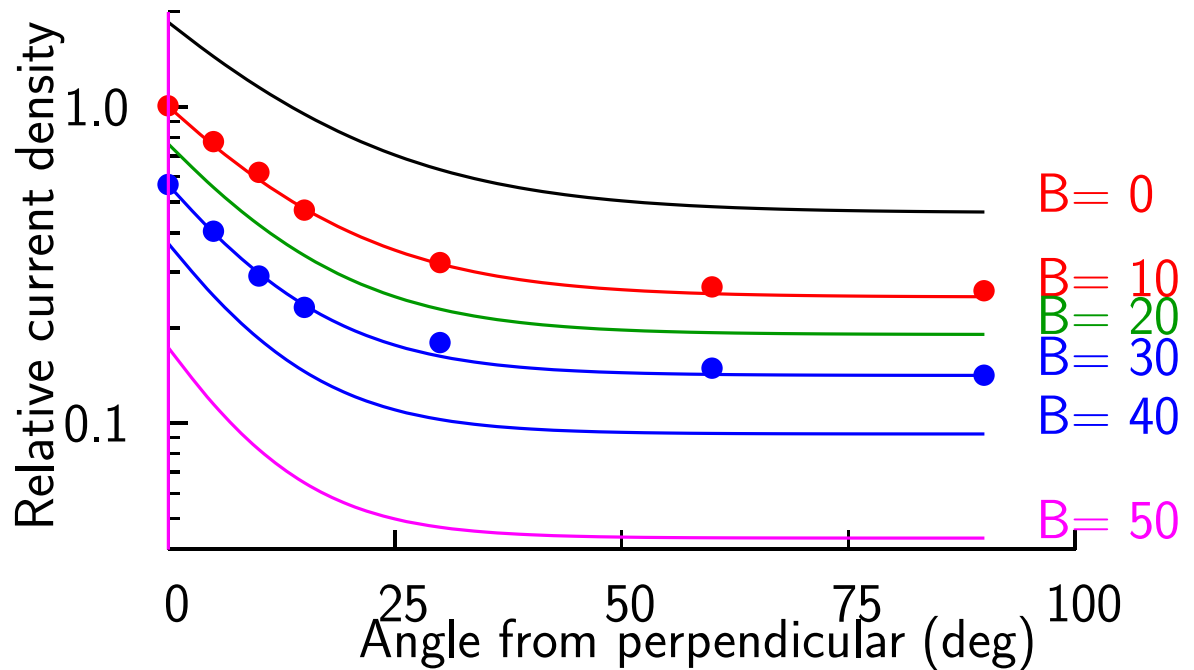

$$\frac{j(\theta)}{j(0)} = (0.25 + 0.75 \exp(-[0.07 + 0.01 B]\theta(deg)))$$

- Absolute normalization from Barzi at 10 T, including insulation

$$j(10) = \frac{720}{(4.4 + 0.13)(0.145 + .025)} = 935 A/mm^2$$

- The resulting dependency is not for the material used, or for any single sample and is used only to get an approximation to actual performance

$$j = 935 (0.25 + 0.75 \exp(-[0.07 + 0.01 B]\theta(deg))) \sqrt{(1.45(1 - 0.08 B))^2 + (1.16 (1 - 0.017 B))^2}$$

BNL work on HTS Quadrupole for RIA/FRIB

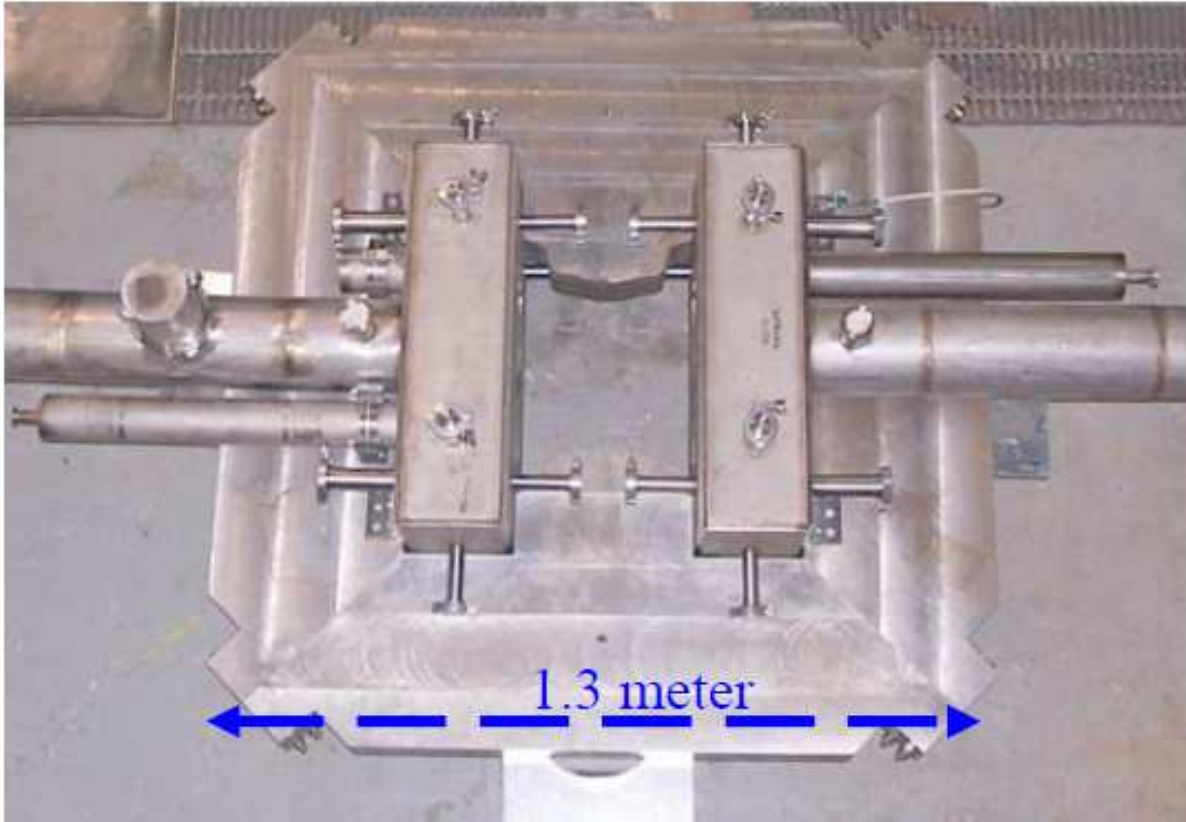

- Iron pole quadrupole built and tested
- Iron is warm
- HTS (BCCO) coils at ≈ 70 degrees in cryostats

Winding

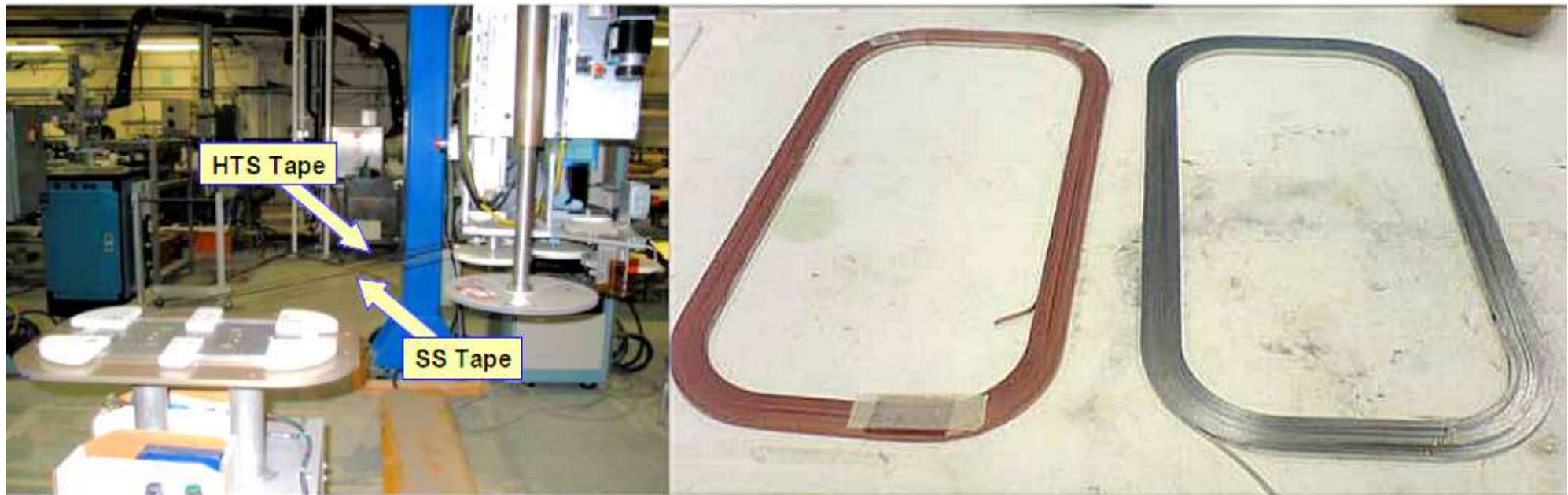

- Stainless steel tape used for 'insulation'
- Because it is radiation hard
- But is also strong and a good enough insulator including for quench protection

Individual HTS BCCO Coil Performance

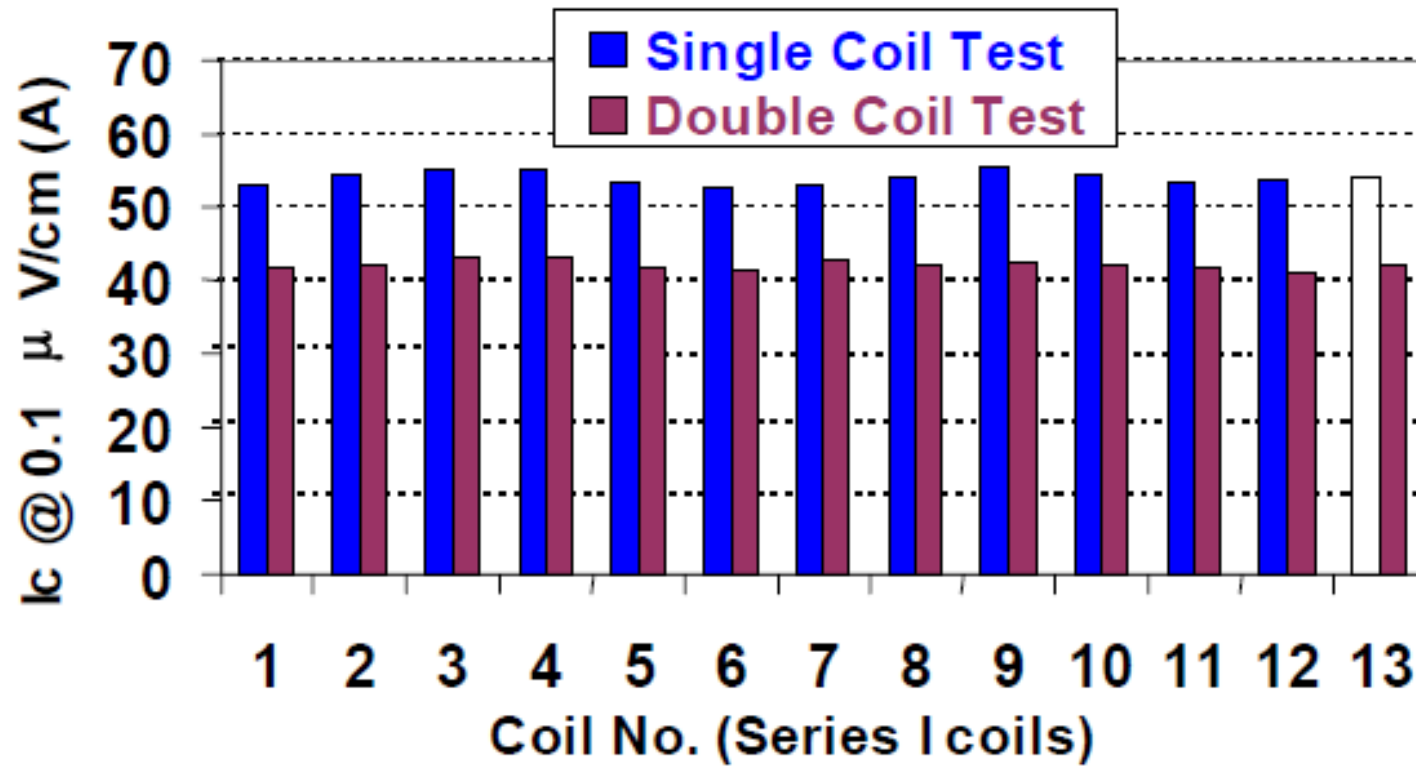

- Reproducible Performance of many coils

Test of YBCO in RIA Coil

FRIB HTS Quad Coil Measurements at BNL

I_c ($0.1 \mu\text{V}/\text{cm}$) Vs. Temperature

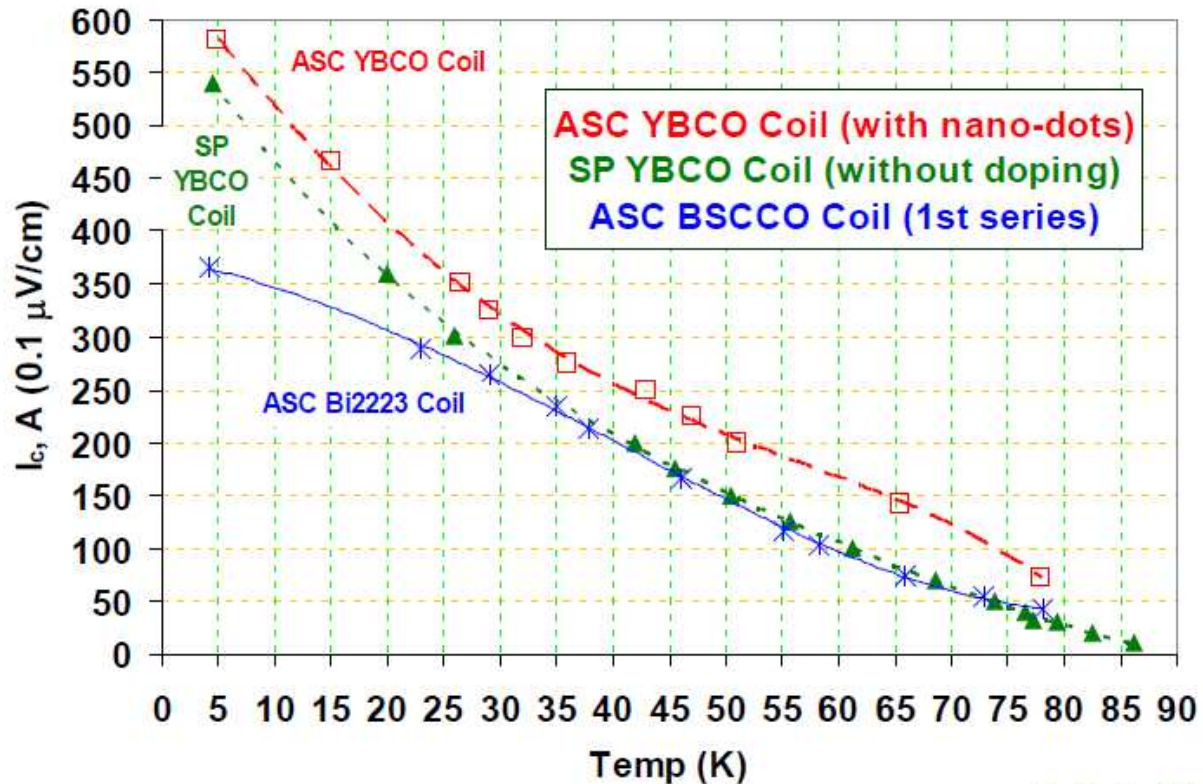

Feb 4, 2008

R. Gupta, BNL

- YBCO superior to 2223 BCCO
- Current densities can be VERY high ($> 1000 \text{ A}/\text{mm}^2$)
- But seemed to be ok [will come back to this](#)

Muon Collider final cooling requirements

- Lower Field Requires lower energies
 - Lower energies face faster growth of loss
 - Faster increase in dp/p
 - Greater Long emit increase
 - May not be accepted by Collider Ring
-
- 50 T is good
 - 40 T may be acceptable
 - 30 T probably not

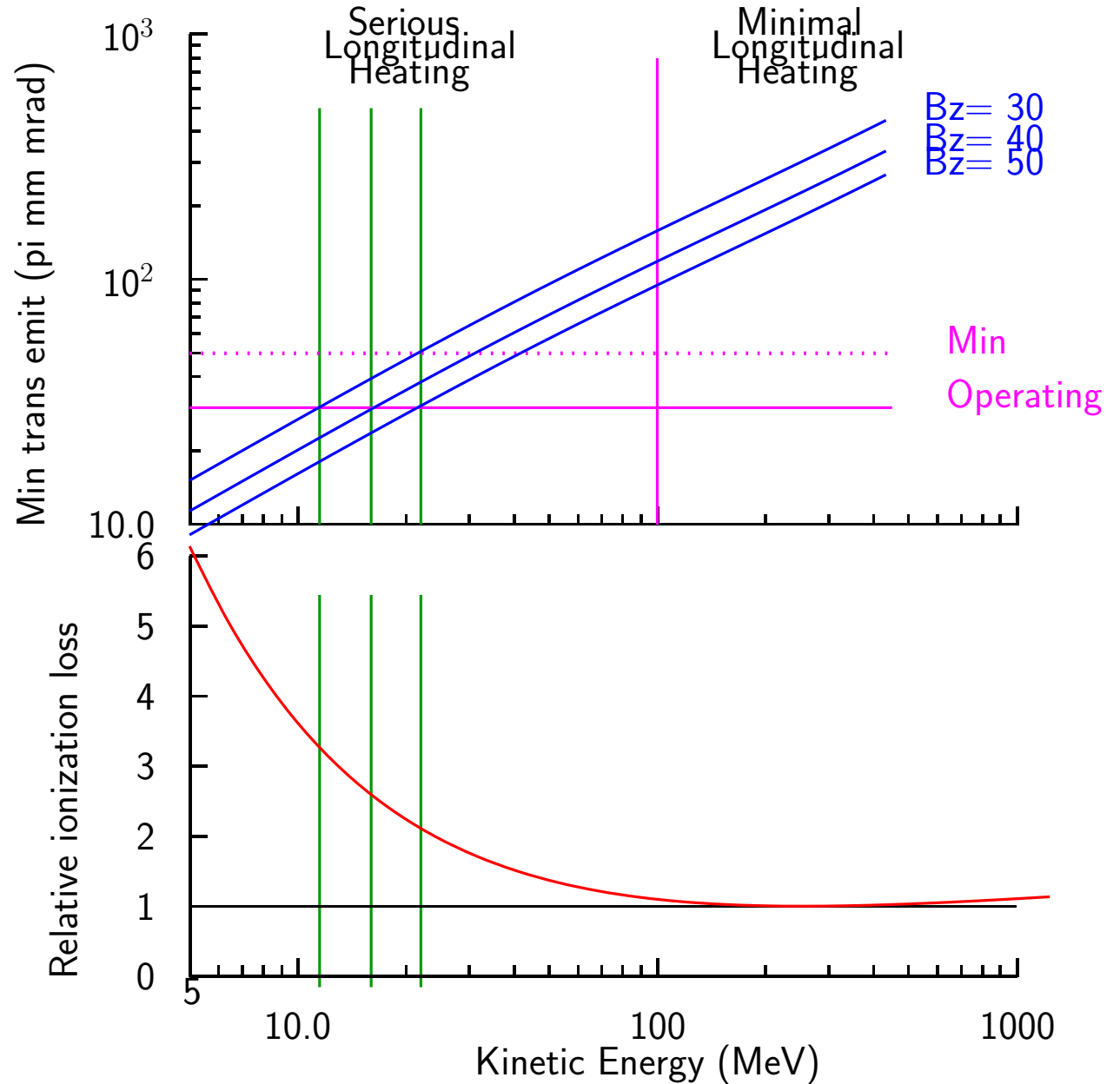

Magnet requirements for final cooling

Number of magnets	≈ 20	More if field is lower
Lengths	$\approx 1\text{m}$ at start	$\approx 10\text{ cm}$ at end
Beam sigmas	4 mm at start	0.7 mm at end
Minimum magnet bore	2 cm at start	1 cm at end
Field Quality	very loose	very loose

BNL/PBL SBIR Program

- First phase 2 SBIR:
 - Study 6D cooling using 10 T solenoids
 - Build 10 T Solenoid 10 cm diameter bore
 - Chose to use YBCO to explore very high current densities → compact
- Second phase 2 SBIR:
 - Study final cooling in 40-50 T solenoids
 - Build 12 T YBCO Solenoid 2.5 cm diameter bore that fits inside #1
 - Test both solenoids in 19 T magnet at NHMFL
- Final field calculated → 40 T, but this is R&D. Nothing is guaranteed
- The Wilsonian approach: start building
- Current status
 - All YBCO tape finally arrived
 - 17 of 28 pancakes of first magnet wound
 - Testing started

Some details

	Length	Inside diam	Outside diam	Stand alone field
	mm	mm	mm	T
NHMFL Resistive	595	233	1010	19
YBCO #1	128	100	165	10
YBCO #2	64	25	95	12

- YBCO width \approx 4 mm
- YBCO Thickness \approx 100 microns
- Length per pancake for #1: \approx 100 m
- Length per pancake for #2: \approx 50 m
- Insulation: 25 micron stainless steel tape
- Wound dry with conductor and insulation 'in hand'
- Pancake 'painted' with epoxy to allow handling Not vacuum impregnated
- Splices, as needed, in winding
- Splice pancake to pancake at center using 8 mm tape
- Voltage taps at center and 4 spaced through coils

NHMFL 19 T Resistive magnet

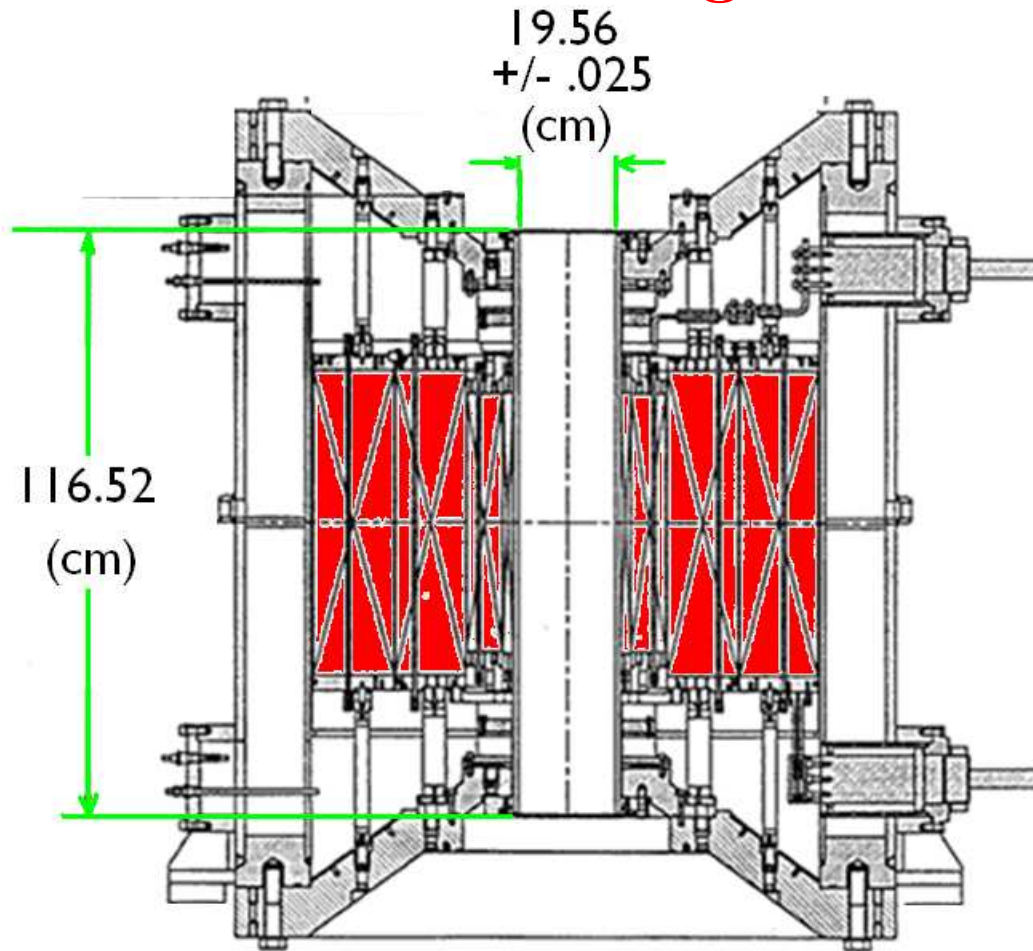

- 19.5 cm dia. bore
- They have cryostat that we can use
- Uses ≈ 20 MW
- A superconducting magnet with these parameters commercially available

HTS magnets in 19 T Resistive

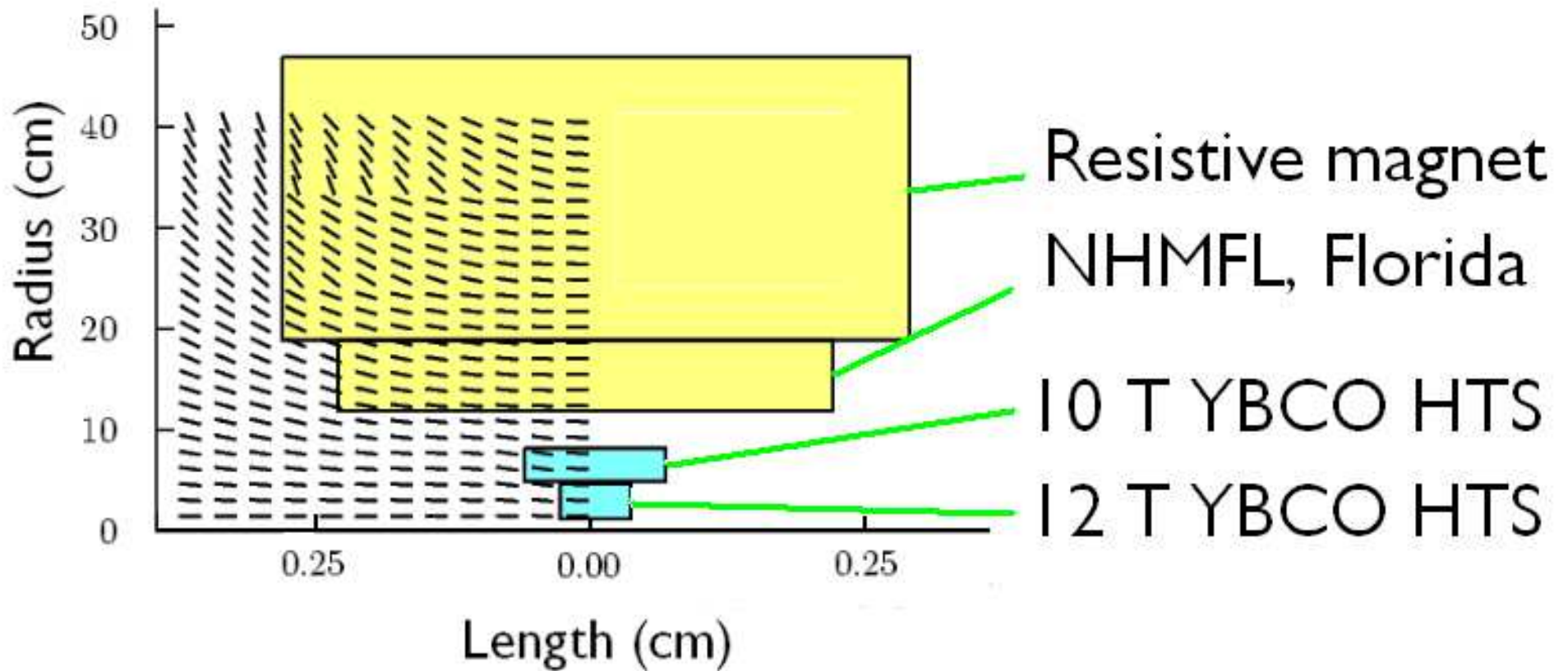

- Nominal Fields: $10 + 12 + 19 = 41$ T
- But we must calculate using field and angle dependent densities

Maximum performance without resistive magnet

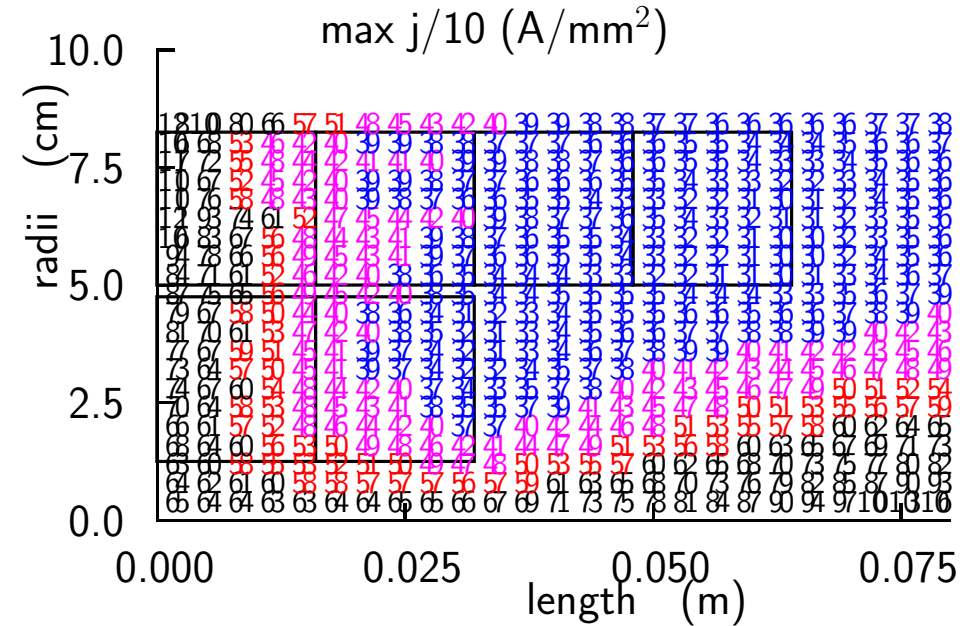
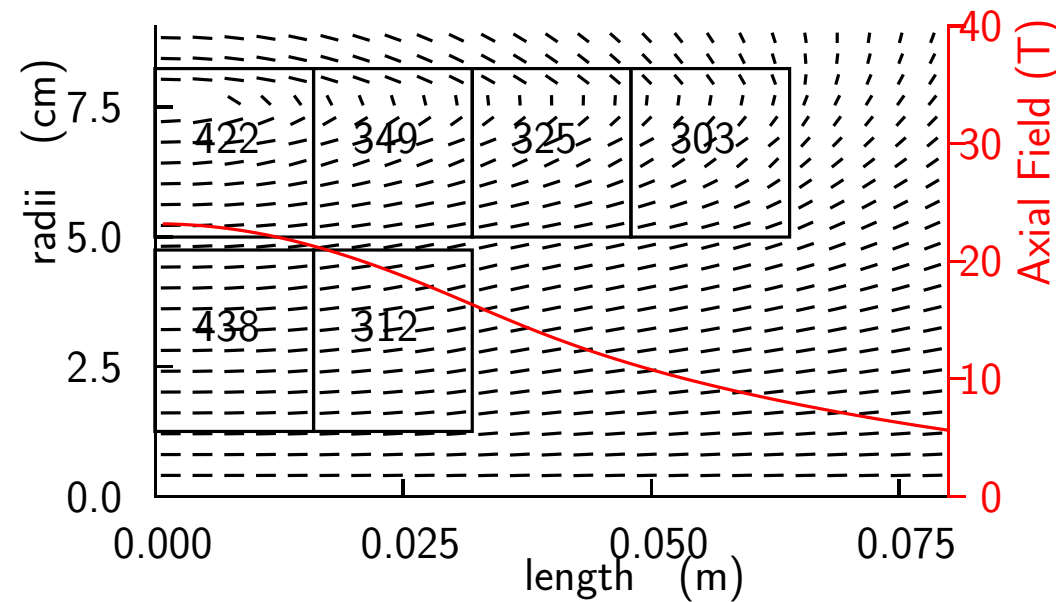

- Maximum current densities calculated from field and angles
- Current densities kept just below these for each of 12 blocks
- No margin included

		graded	not graded
Central Field	T	23.2	19.8
Maximum current density	A/mm ²	438	342
Maximum Stress	MPa	235	155

Maximum performance with resistive magnet

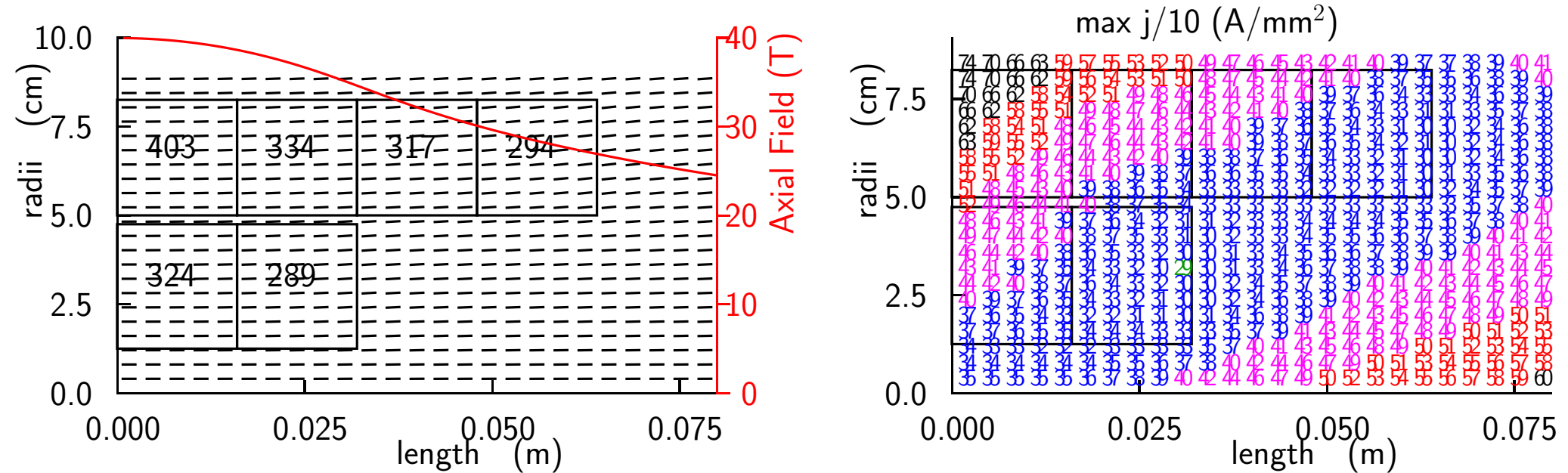

- Maximum current densities calculated from field and angles
- Current densities kept just below these for each of 12 blocks
- No margin included

		graded	not graded
Central Field	T	39.9	38.3
Maximum current density	A/mm ²	403	402
Maximum Stress	MPa	668	487

Strains and their consequences

- Maximum hoop stresses are in outer coil
- Young's modulus of HTS tape: 140 GPa
- Young's modulus including stainless insulation:

$$E = \frac{100 \cdot 140 + 25 \cdot 200}{125} = 152 \text{ (GPa)}$$

Case	Field T	Stress MPa	Strain %
Without 19 T ungraded	19.8	155	0.102
Without 19 T graded	23.2	235	0.16
With 19 T ungraded	38.3	487	0.32
With 19 T graded	39.9	668	0.44

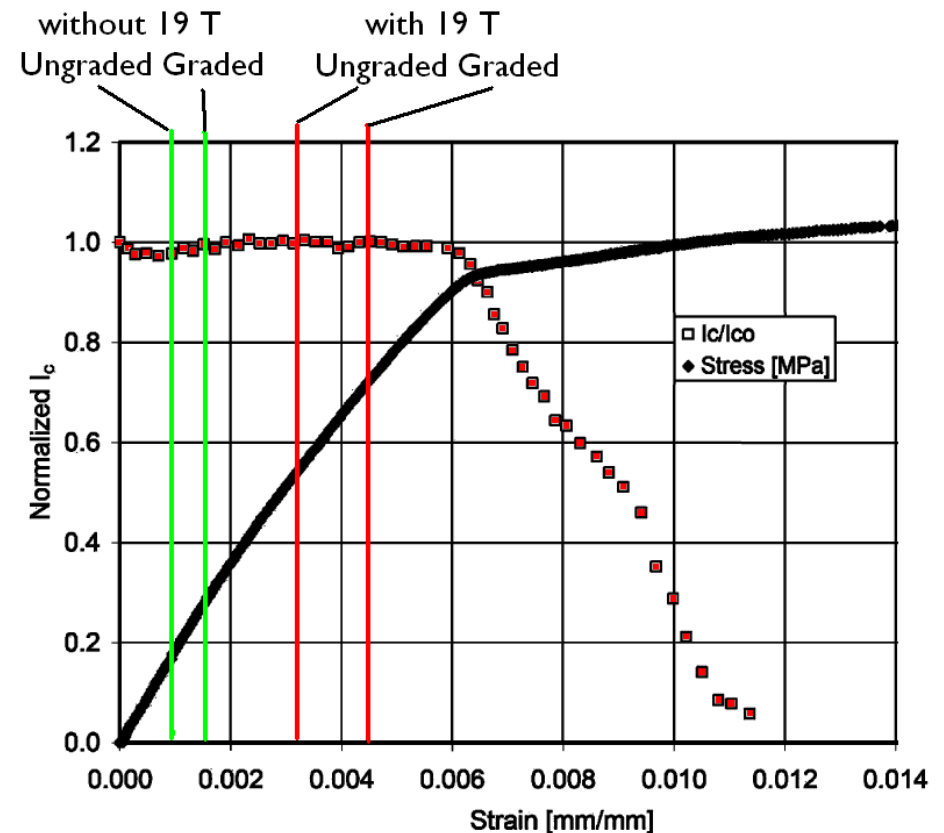

- Strains are higher when the currents in the coils are graded
- Strains appear well below levels causing loss of performance
- And are below manufacturer's recommended limit of 0.45 %

But fatigue is an issue

Fatigue Behavior of YBaCuO/Hastelloy-C Coated Conductor at 77 K
Abdallah L. Mbaruku and Justin Schwartz

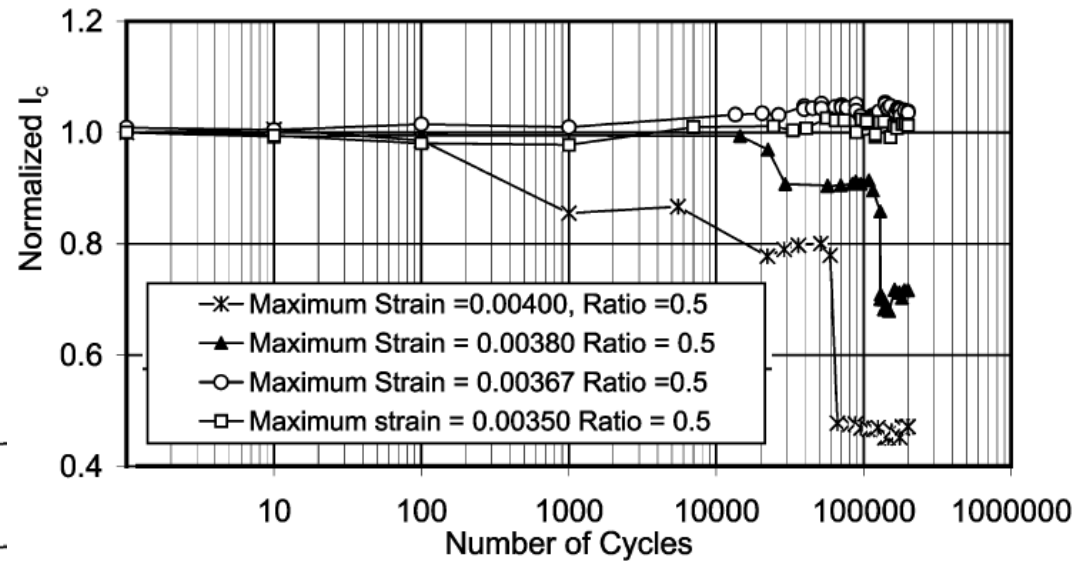
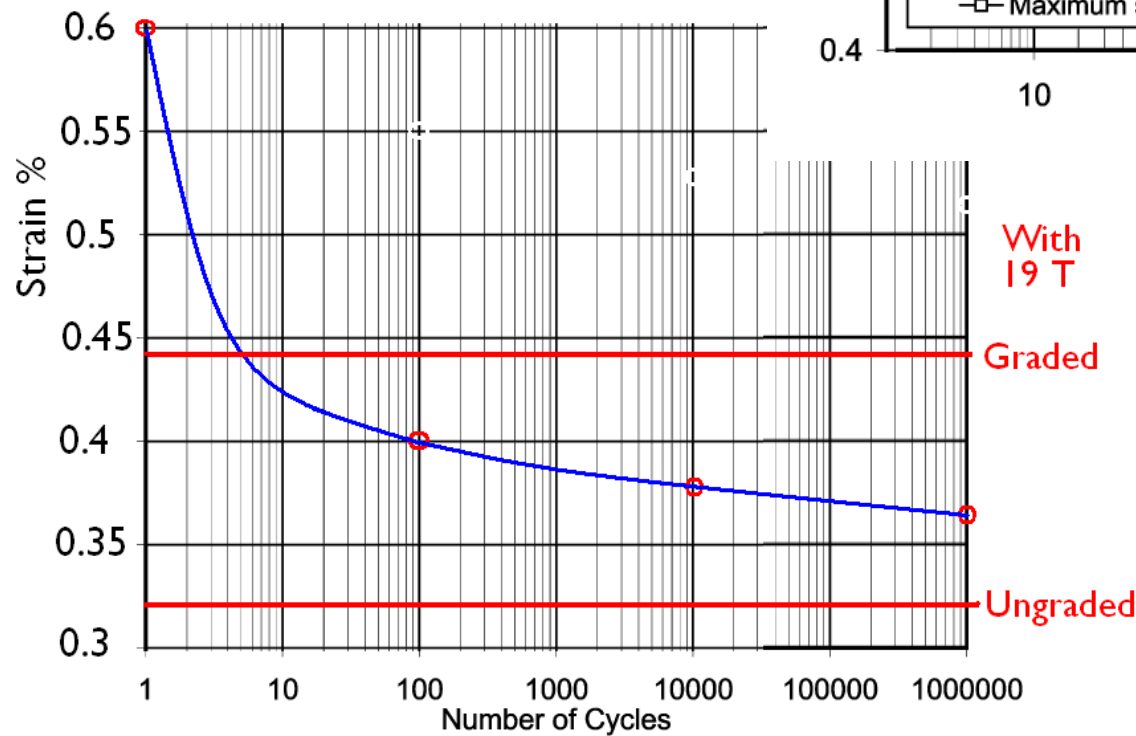

- Stainless steel tapes should be thicker in real magnet for graded case
- Probably ok for this test with limited number of operations

Constraints of tension in tapes

- Turns are under tension to hold Lorentz forces
- This tension must be transferred between 2 coils of pancake
- Can be done on outside by friction between compressed turns below overwrap

On outside

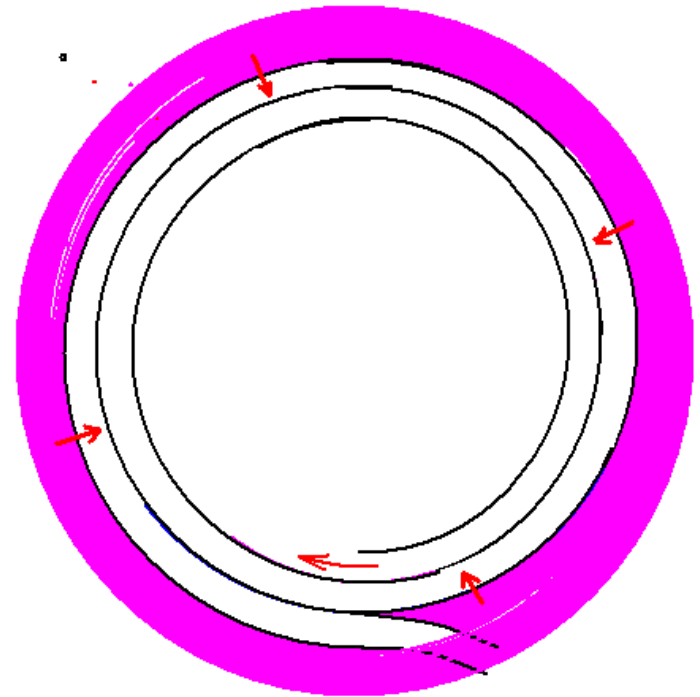

On Inside

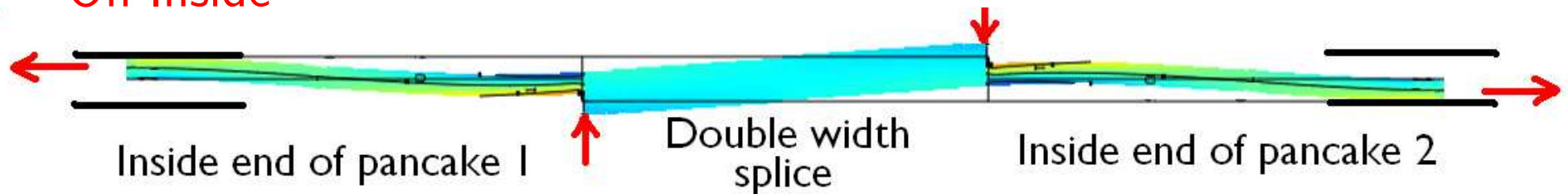

- On inside, splice is pulled skew by tape tensions
- Splice must be long
- Must be constrained on either side

Measurement of stainless steel 'Insulation'

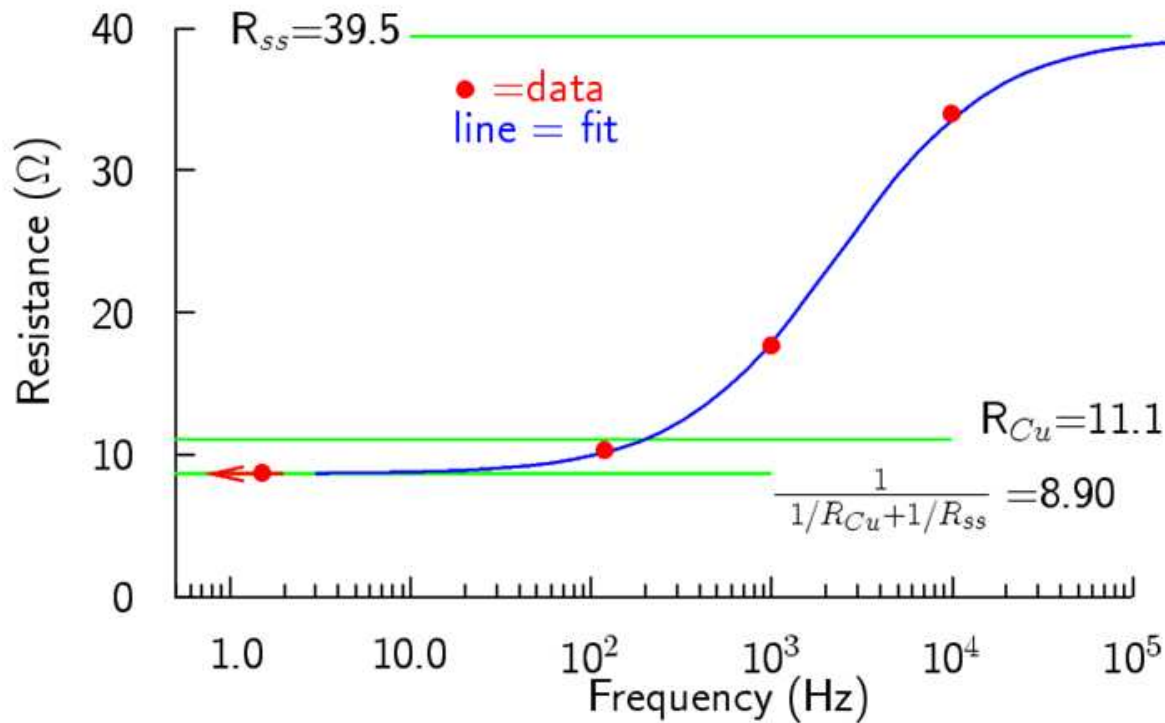

$$R(f) = \frac{1}{\frac{1}{R_{ss}} + \frac{1}{R_{Cu} + L \times f}}$$

- Measure impedance vs. Frequency
- Impedance through copper in tape increased with frequency
- Impedance through ss does not
- Fit gives resistance through ss, per pancake, of 39.5 ohms

Quench Protection

For temp rise < 200 K, and $RRR=50$ (including magneto resistance)

$$\int j^2 dt < 10.6 \cdot 10^{16} \quad (Am^{-4}s)$$

Cu thickness $40 \mu m$ Total thickness $125 \mu m$ $j_{Cu} = 3.125 \times j$

The required time constant is

$$\tau = \frac{2 \cdot 10.6 \cdot 10^{16}}{j_{Cu}^2}$$

The external shunt resistor needed

$$R = \frac{L}{\tau} \quad L = 2U/I^2$$

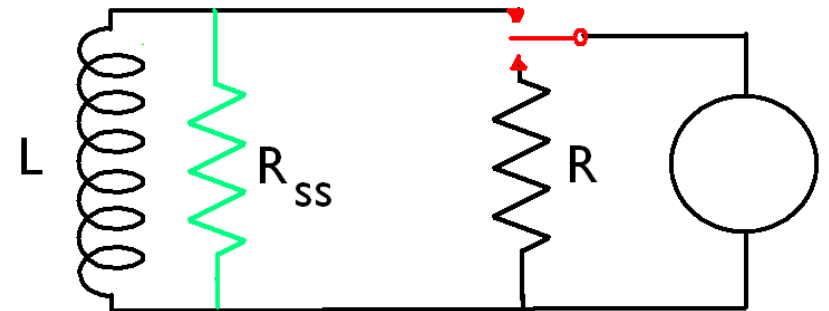

Getting the inductance L from the ungraded example

$$U=80 \text{ kJ, and } I = j t w = 320 \cdot 4.4 \cdot 0.125 = 176$$

Parameters for Quench Protection

Case		j	j_{Cu}	τ	R	$\langle I \rangle$	V
		A/mm ²	A/mm(max) ²	sec	Ω	A	kV
without 19 T	ungraded	342	1069	0.18	29	176	5.1
	graded	438	1369	0.11	47	197	9.3
With 19 T	ungraded	302	944	0.24	21.5	166	3.6
	graded	403	1259	0.13	40	180	7.2

Because of the high current densities in the copper, the required time constants are short

In all cases, the external resistor is small compared with the leakage resistance through the stainless steel insulation of $\approx (28+14/2)39.5 = 1380$ ohms
So a negligible part of the energy is dumped in the ss insulation

The above voltages are calculated for all coils in series. But multiple quench protection circuits are needed. e.g for 12 blocks: $V \leq 770$ Volts

Having multiple circuits does not change the calculated ratios of stainless steel resistance to external resistors

Progress and coil tests

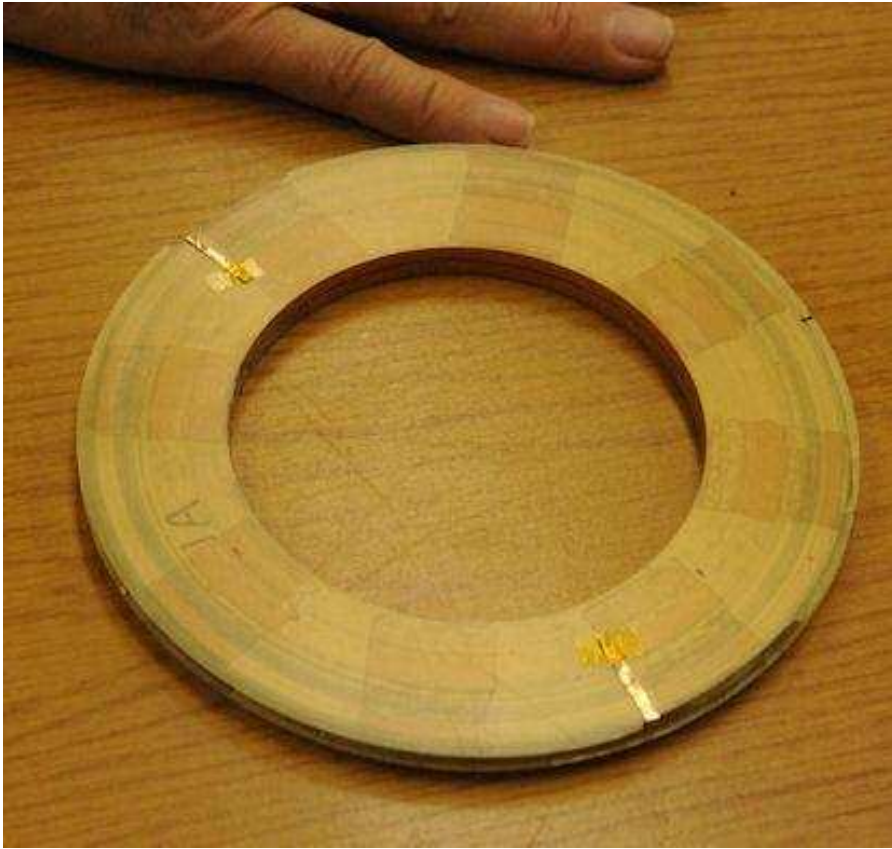

Single pancake



testing assembly

Test of 2 double pancakes

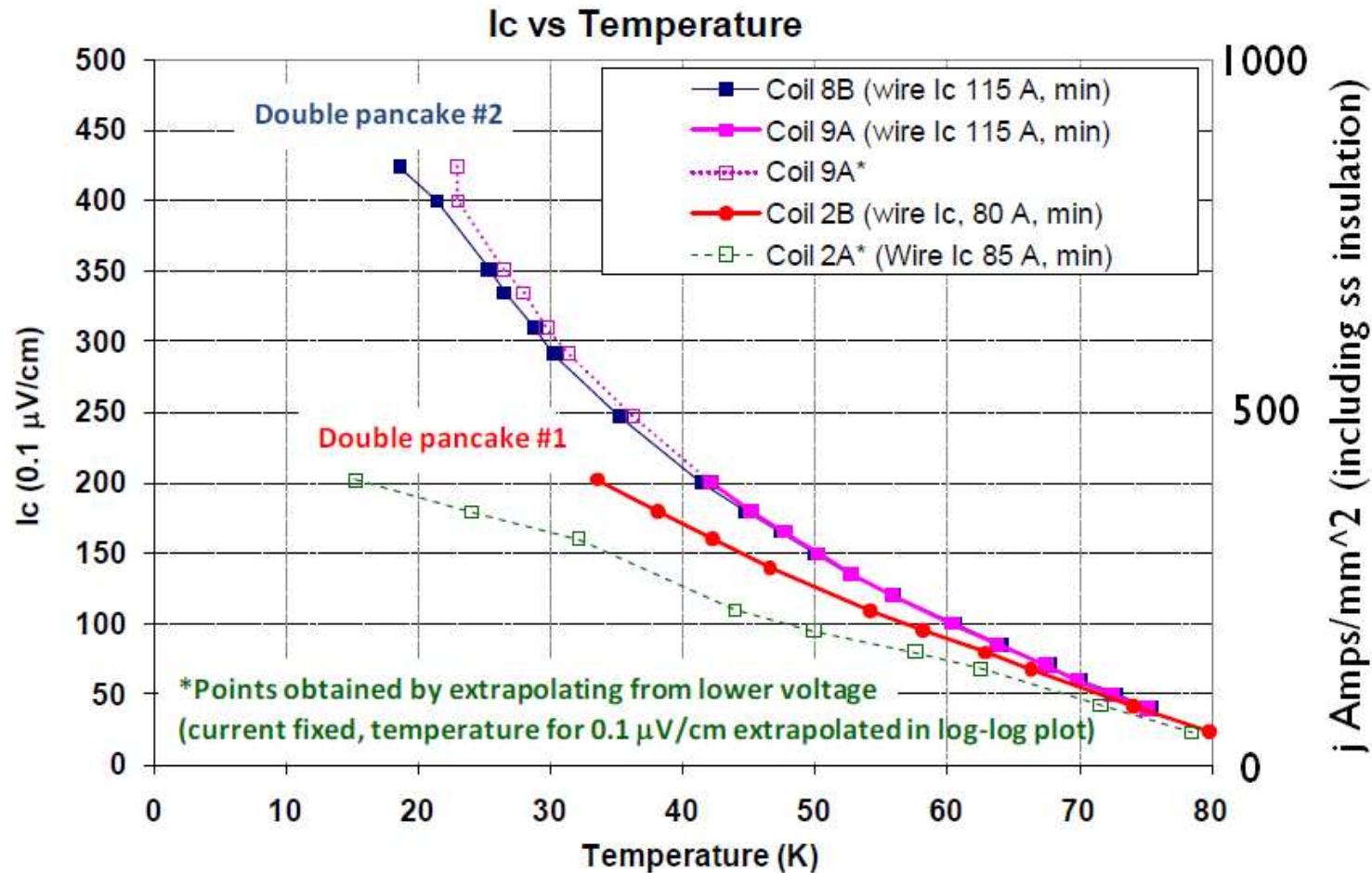

- One pancake of #1 appears damaged probably during a previous 'quench'
- Current density in test is very high though lower than in RIA/FRIB test
- Quench protection is probably needed

Safe time constant $\propto 1/I^2$ For 400 A $j_{Cu}=2780$ (A/mm²) $\tau=27$ msec

Conclusion

- YBCO has significantly better performance than BCCO
- Magnetization probably prohibits its use in accelerator magnets but ok for Muon Collider final cooling
- Final cooling probably needs $B \geq 40$ T
- Two funded Phase II BNL/PBL SBIRs are exploring YBCO use at fields approaching 40 T, when tested in the NHMFL 19 T resistive solenoid
- Design study finds no show stopper, including
 - j_c including angle effects
 - Strains in the conductor, including fatigue
 - Quench protection
- Progress
 - Required tape delivered
 - 17 (out of 28) outer pancakes wound
 - Preliminary testing of double pancakes started
- 40 T is unlikely to be achieved in this magnet, but 'Wilsonian' approach should provide useful information