

Underground Nuclear Astrophysics

Frank Strieder

South Dakota School of Mines & Technology

The 2016 R-Matrix Workshop on Methods and Applications

Santa Fe, New Mexico, USA

June 28th, 2016

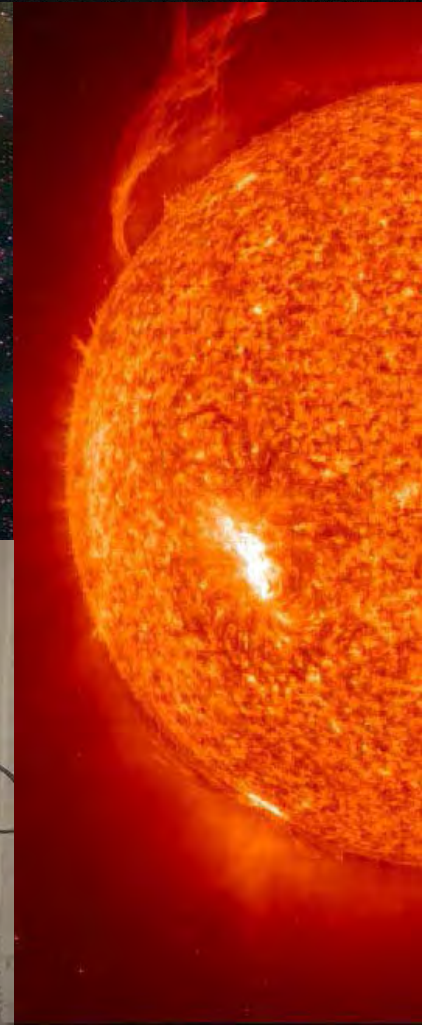
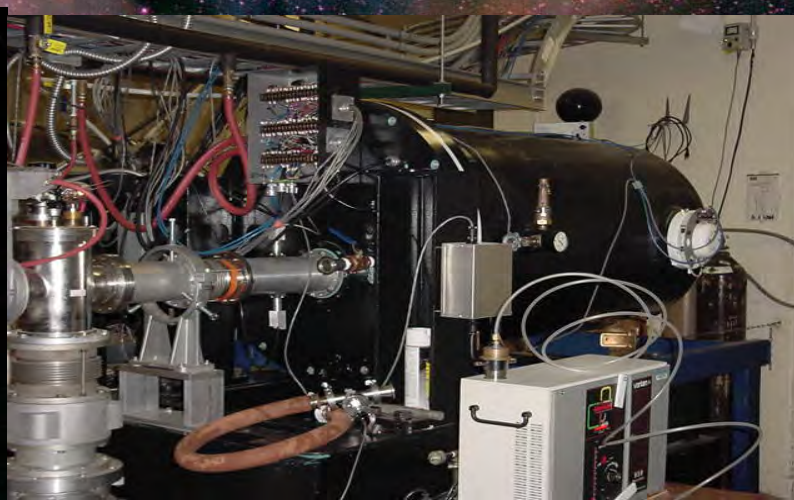
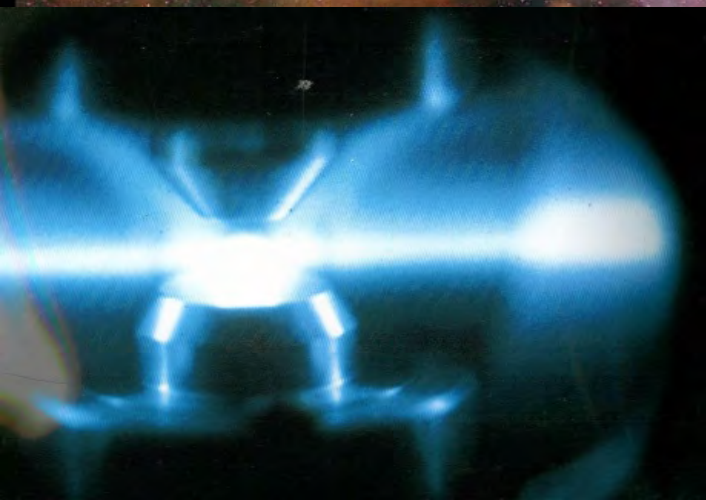
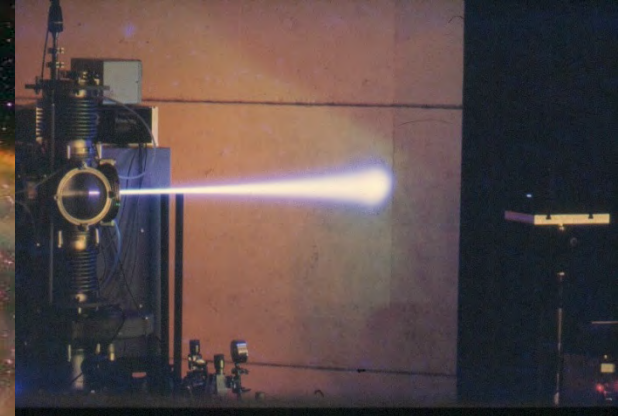

What is Matter made of?

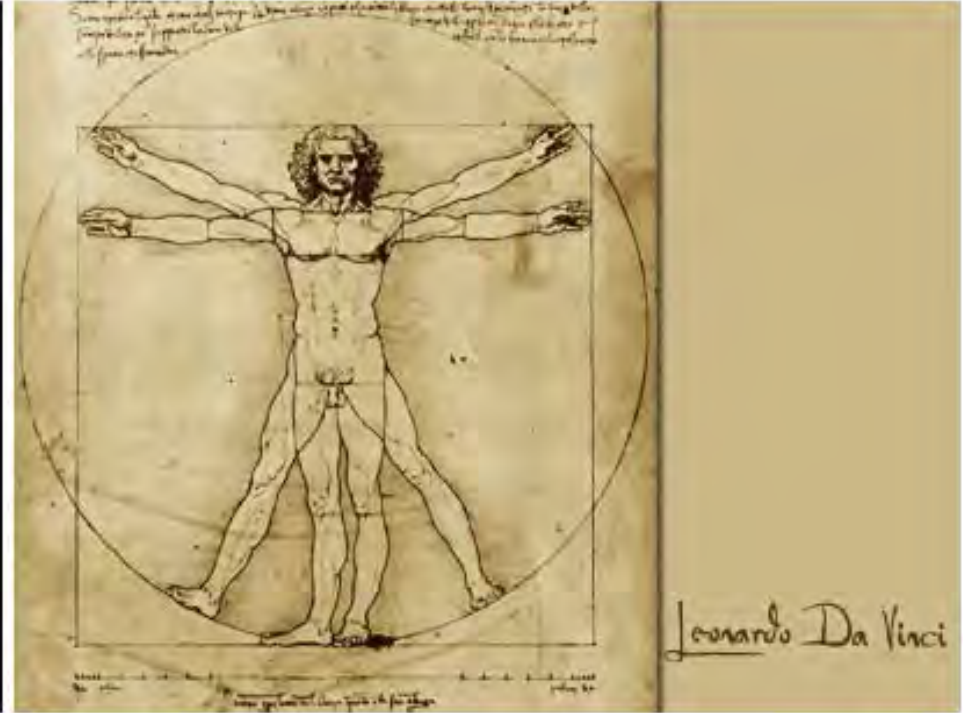

SOUTH DAKOTA



SCHOOL OF MINES
& TECHNOLOGY

A Legacy of Excellence

Solar system isotopic abundance

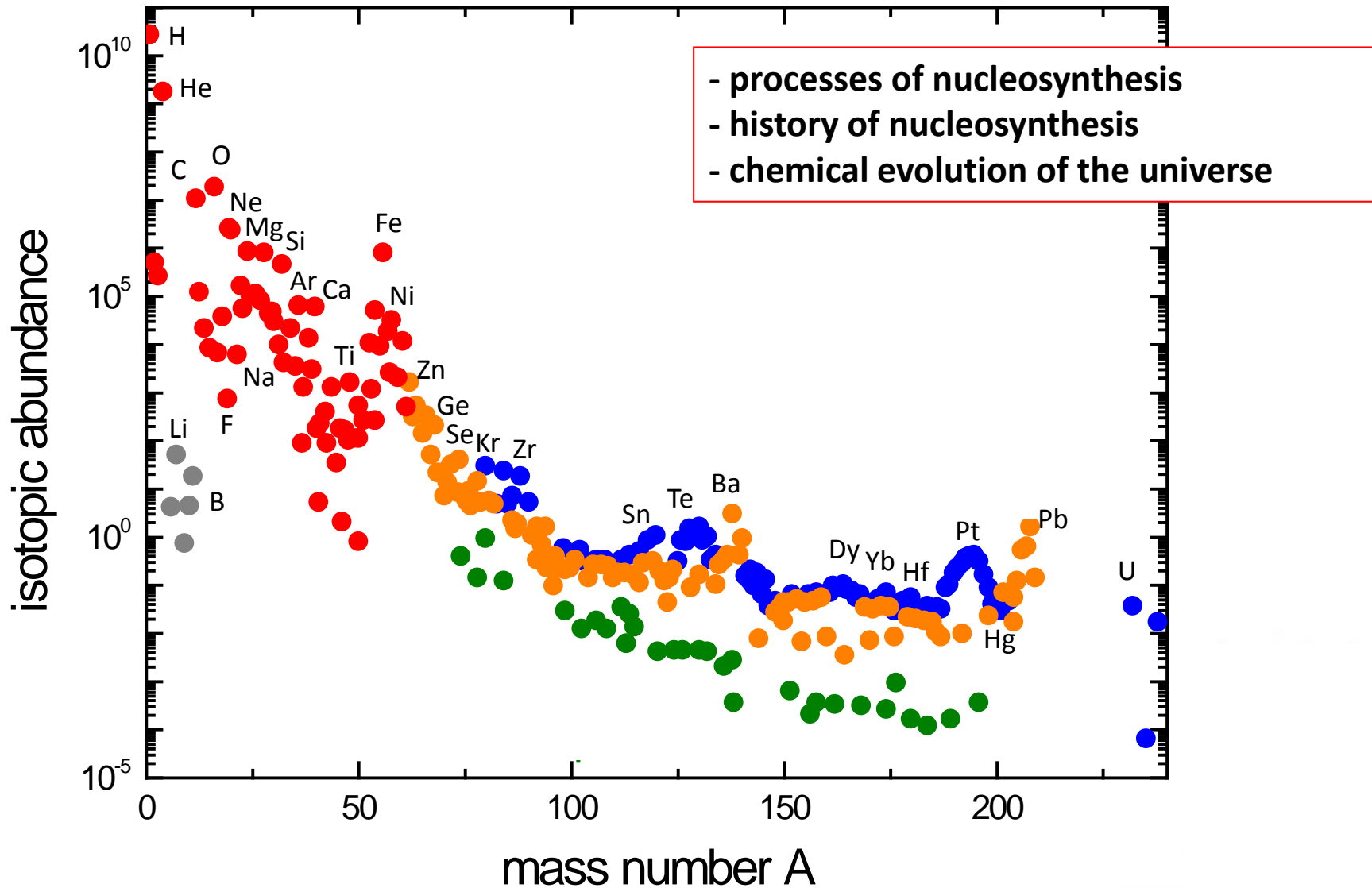

Nuclear reactions at astrophysical energies

nuclear reactions important to provide energy and the neutrons for nucleosynthesis

e.g. pp chain, $^{13}\text{C} + \alpha \rightarrow ^{16}\text{O} + n$ or $^{22}\text{Ne} + \alpha \rightarrow ^{25}\text{Mg} + n$

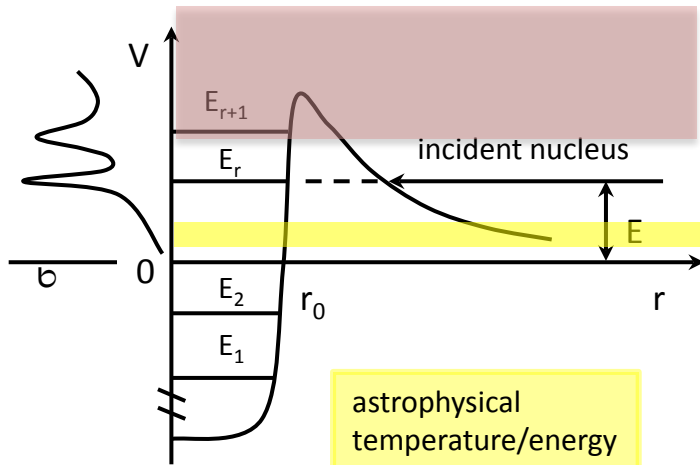

astrophysical
temperature/energy
range

range accessible
with experiments

- occurs at specific energies
- cross section has STRONG energy dependence

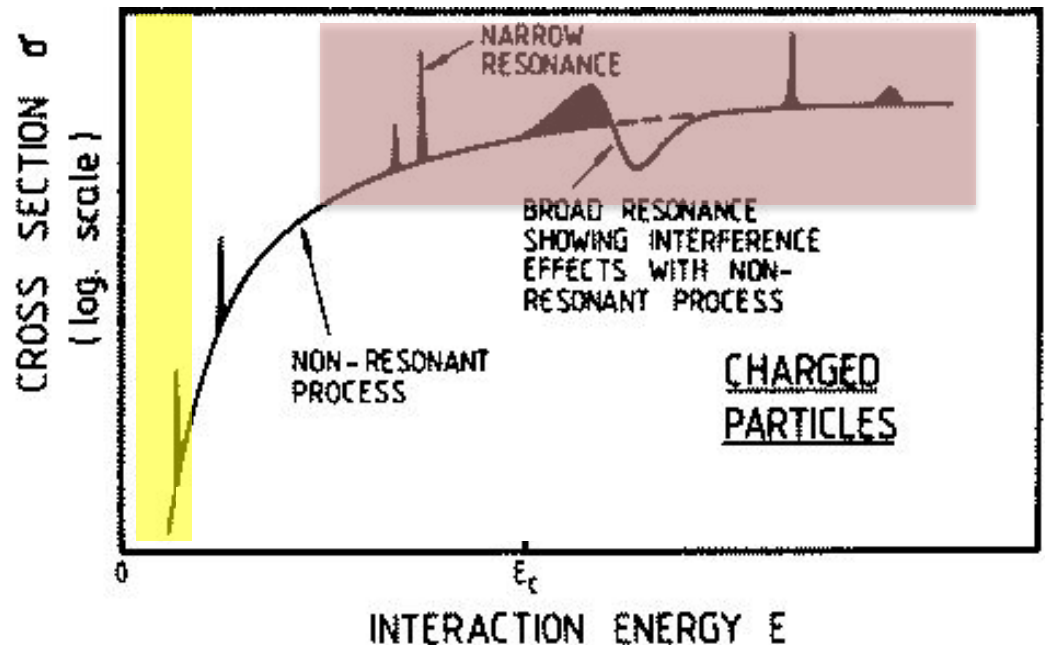

Main Source of Background

- natural radioactivity (from U and Th chains and from Rn)
- cosmic rays
- neutrons from (α, n) reactions and fission

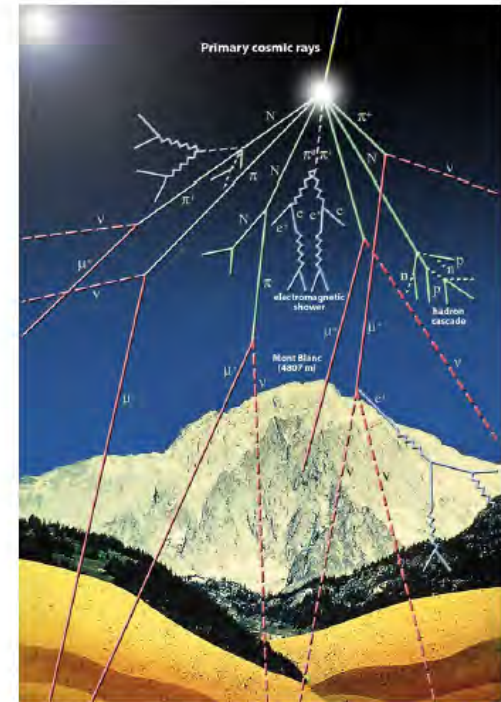
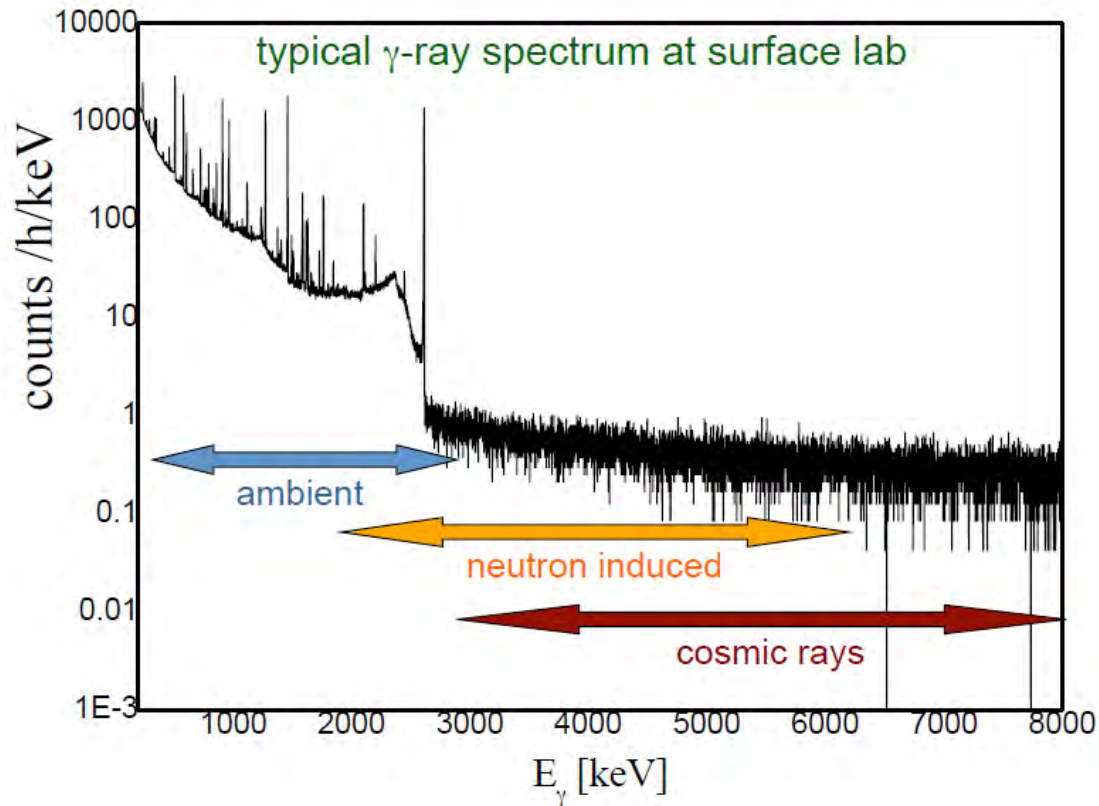

courtesy A. Formicola

Laboratori Nazionali del Gran Sasso Laboratory for Underground Nuclear Astrophysics

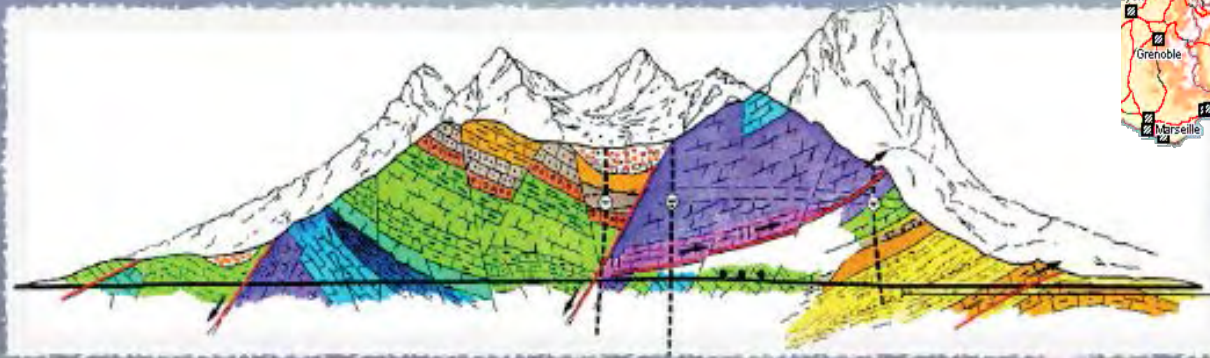

- 1400 m rock overburden (=4000 m w.e.)
- Flux attenuation: $n \cdot 10^{-3}$ (CaCO_3)
 $\mu \cdot 10^{-6}$ ($1/\text{m}^2 \text{ h}$)
- underground area 18000 m^2
- support facilities on the surface

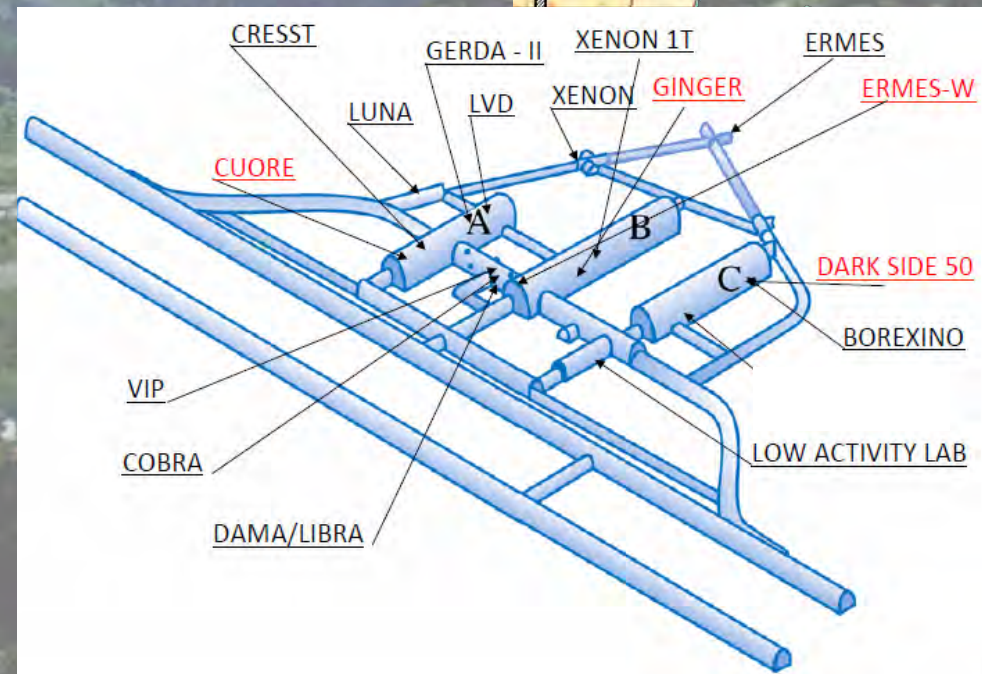

Benefit of an Underground Laboratory in γ -ray spectroscopy

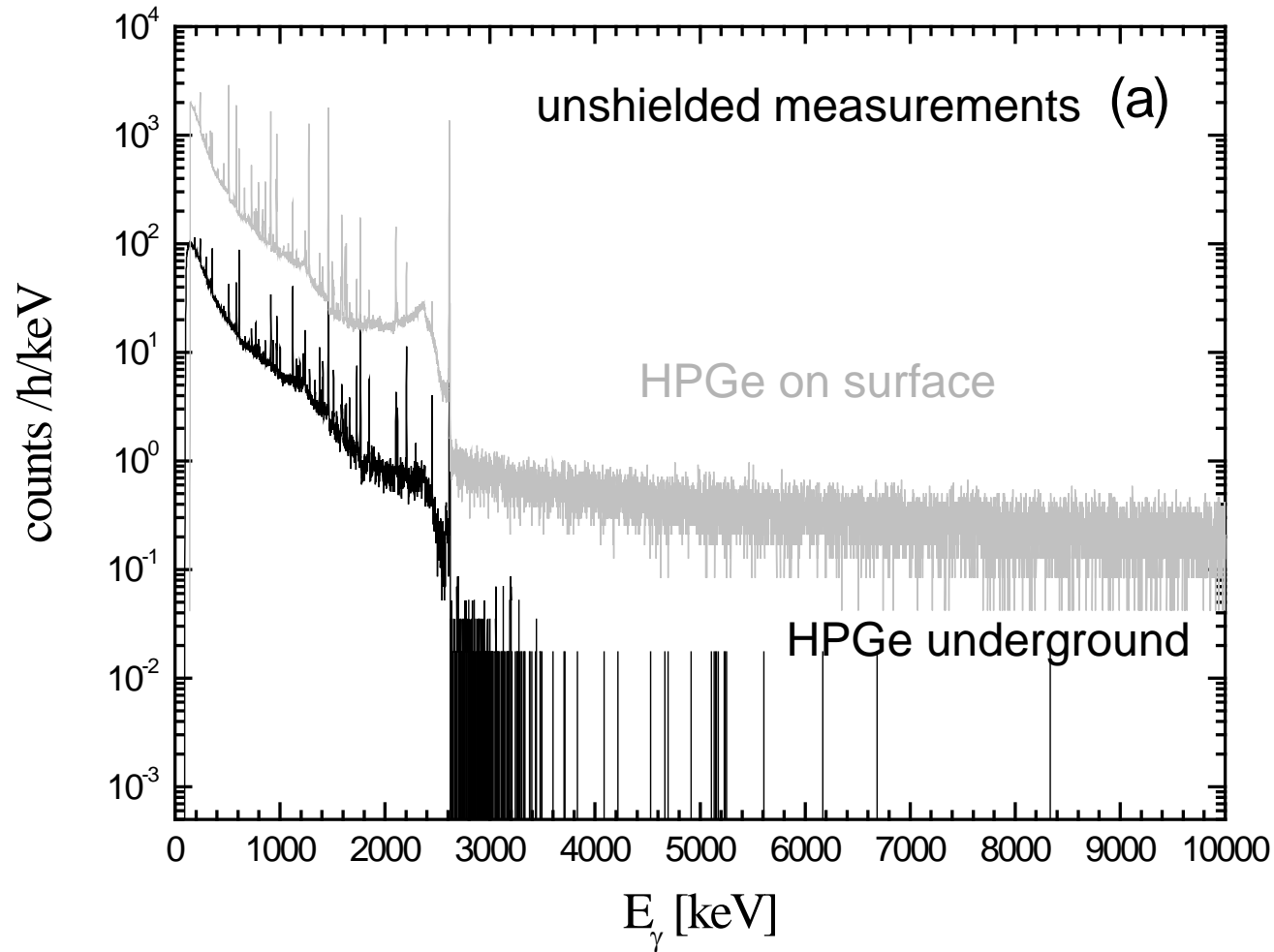

Benefit of an Underground Laboratory in γ -ray spectroscopy

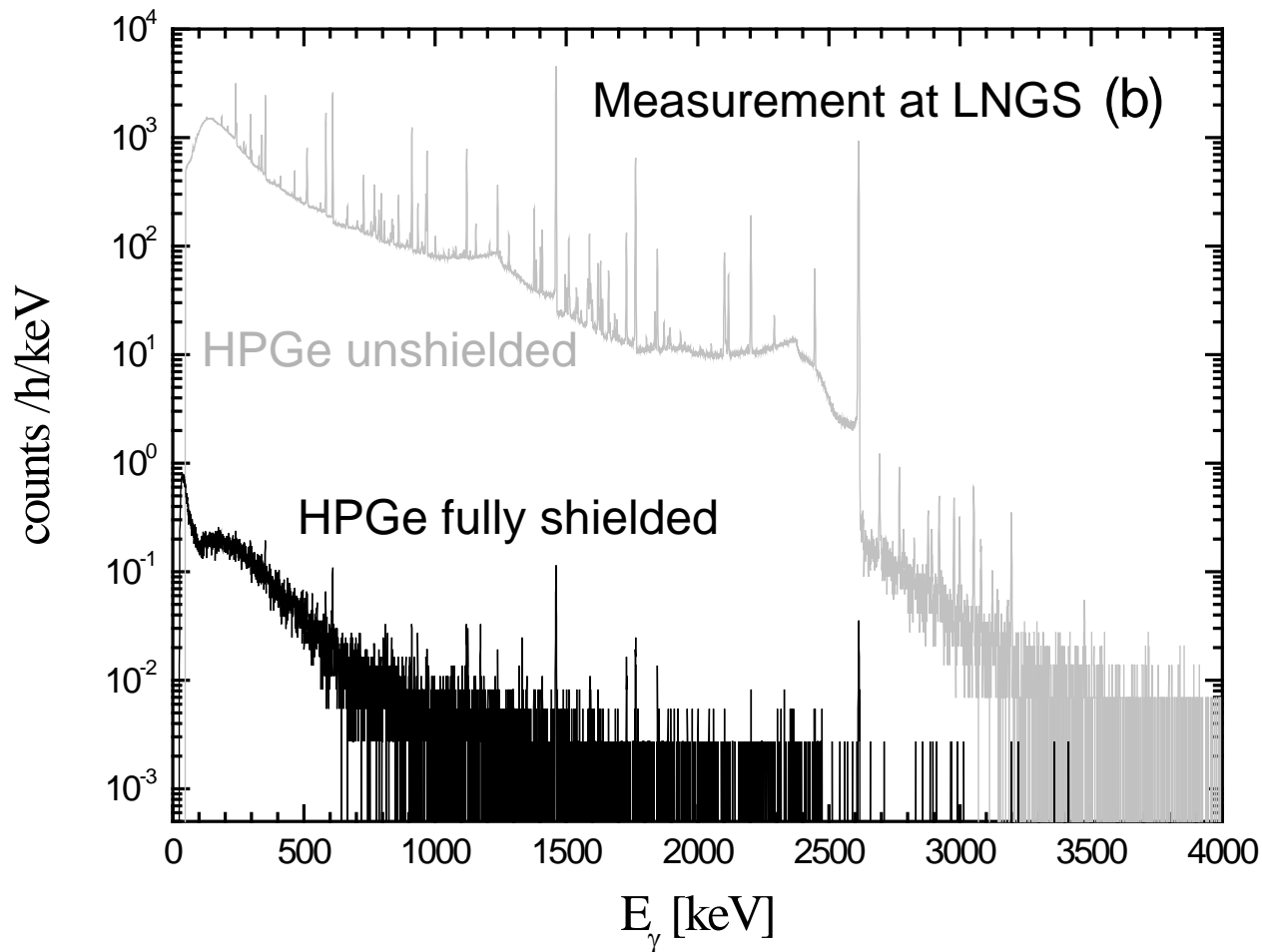

Underground Accelerator: LUNA – The Beginning

1992: Installation of LUNA 50 kV accelerator @ LNGS

participating teams & institutions:

Ruhr-Universität Bochum

2 full time PhD students: Uwe Greife, Matthias Junker

few part time PhD students + senior researcher

Laboratorio Nazionale del Gran Sasso

part time senior researcher: Cristina Arpesella

later PhD student: Alessandra D'Alessandro

INFN Genova

part time senior researcher: Piero Corvisero, Paolo Prati

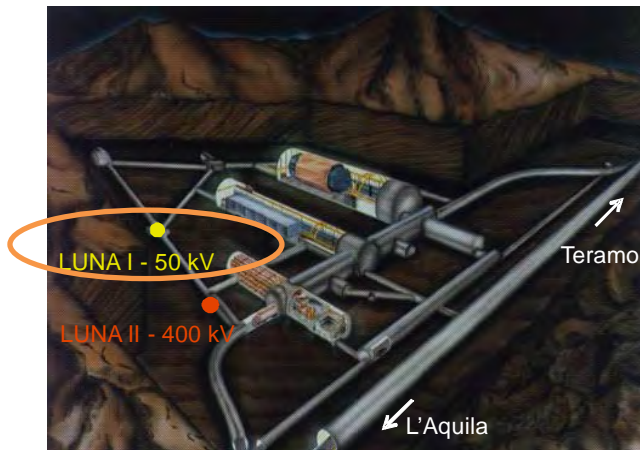

→ 50 kV accelerator & gas target
entirely built by students

LUNA I – Achievements Underground

Two reactions (solar pp chain) already studied at **Gamow energies**:

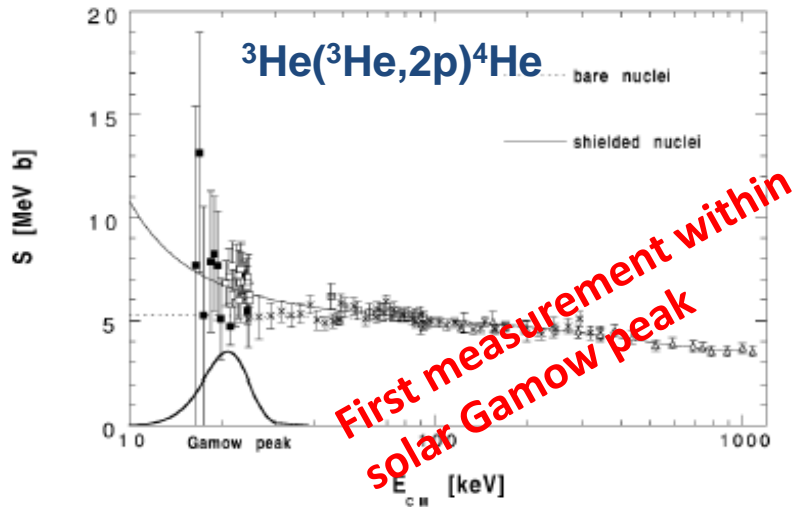

at lowest energy: $\sigma \sim 20 \text{ fb} \rightarrow 1 \text{ event/2 month}$
R. Bonetti et al.: Phys. Rev. Lett. 82 (1999) 5205

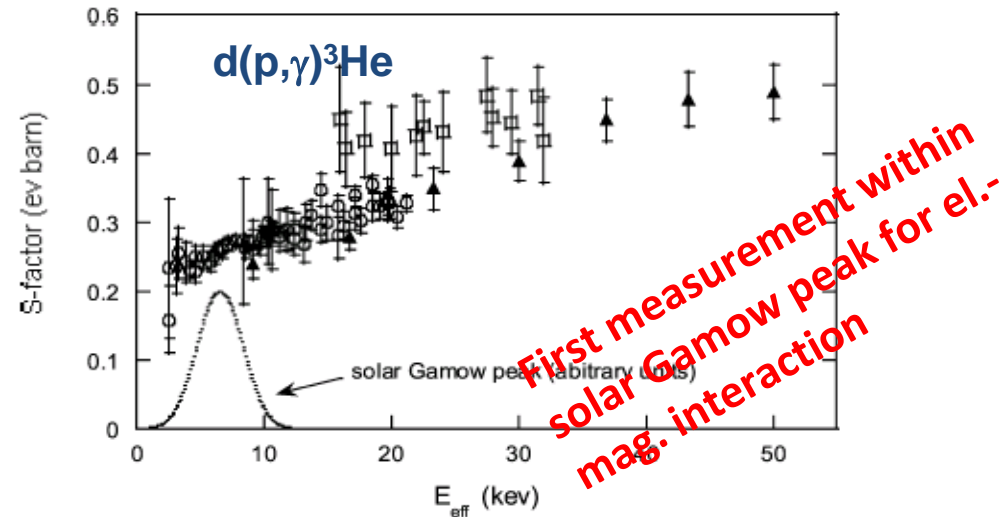

at lowest energy: $\sigma \sim 9 \text{ pb} \rightarrow 50 \text{ counts/day}$
C. Casella et al.: Nucl. Phys. A706 (2002) 203

Definition of astrophysical S factor $S(E)$

$$\sigma(E) = \frac{S(E)}{E} \exp(-2\pi\eta)$$

LUNA II – 400 kV Accelerator (2000 – 2018(?))



$U_{\text{terminal}} = 50 - 400\text{kV}$

$I_{\text{max}} = 500\mu\text{A}$ (on target)

$\Delta E = 0.07\text{keV}$

Allowed beams: H^+ , ${}^4\text{He}$, (${}^3\text{He}$)

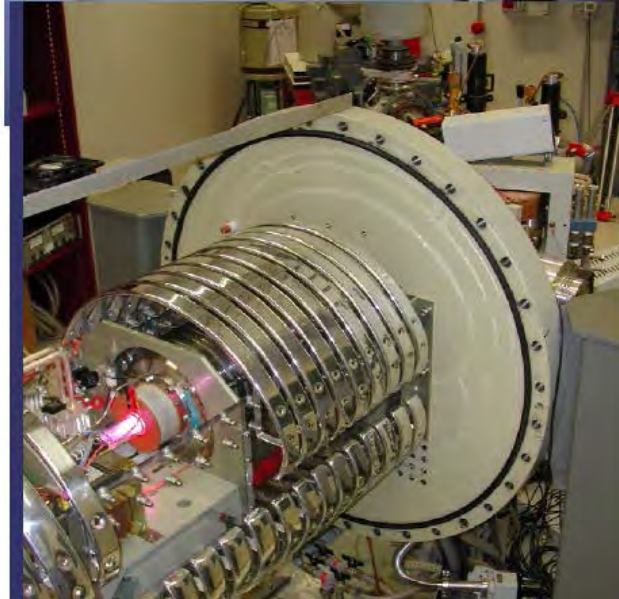

LUNA II – 400 kV Accelerator (2000 – 2018(?))

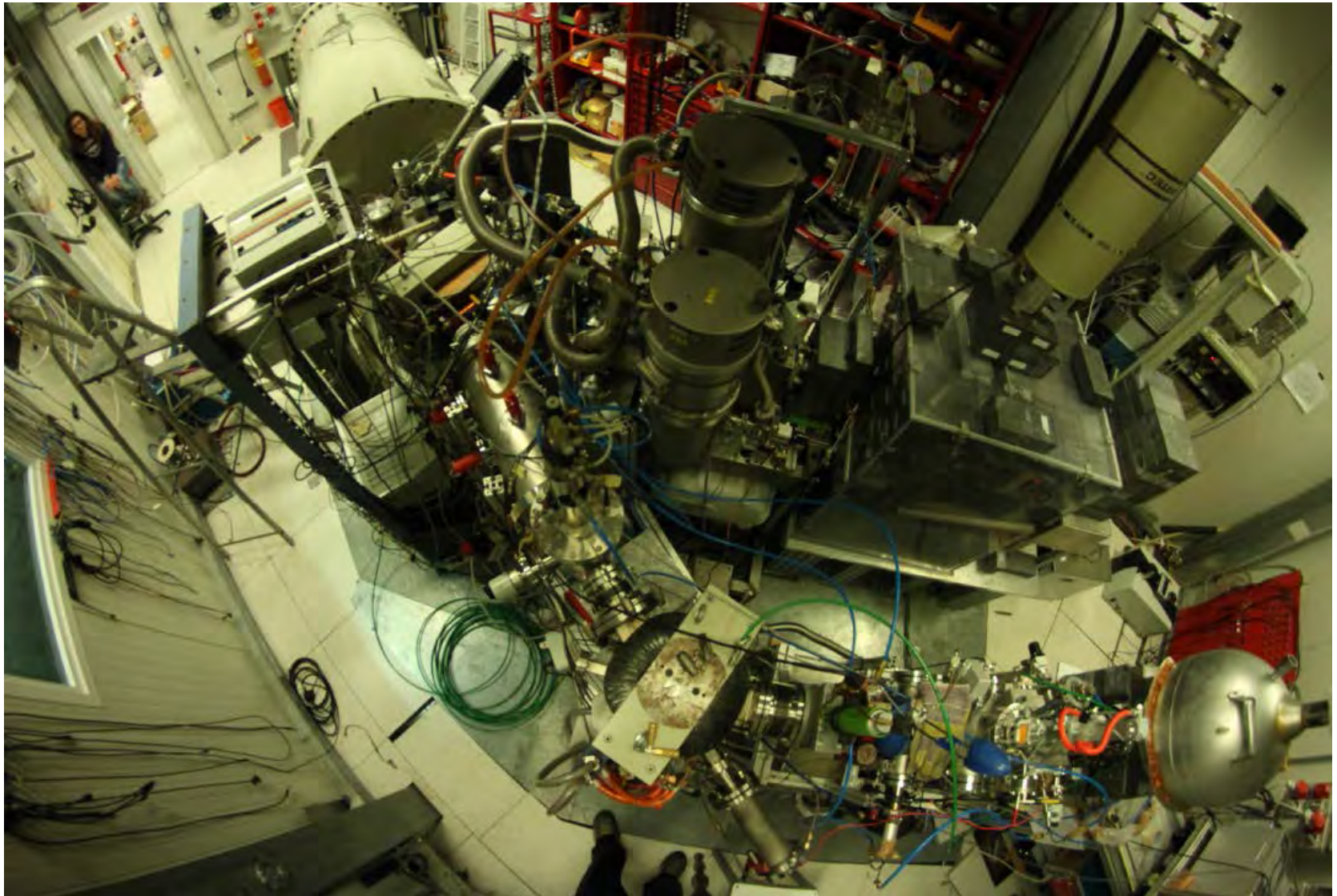

courtesy A. Formicola

LUNA II – 400 kV Accelerator (2000 – 2018(?))

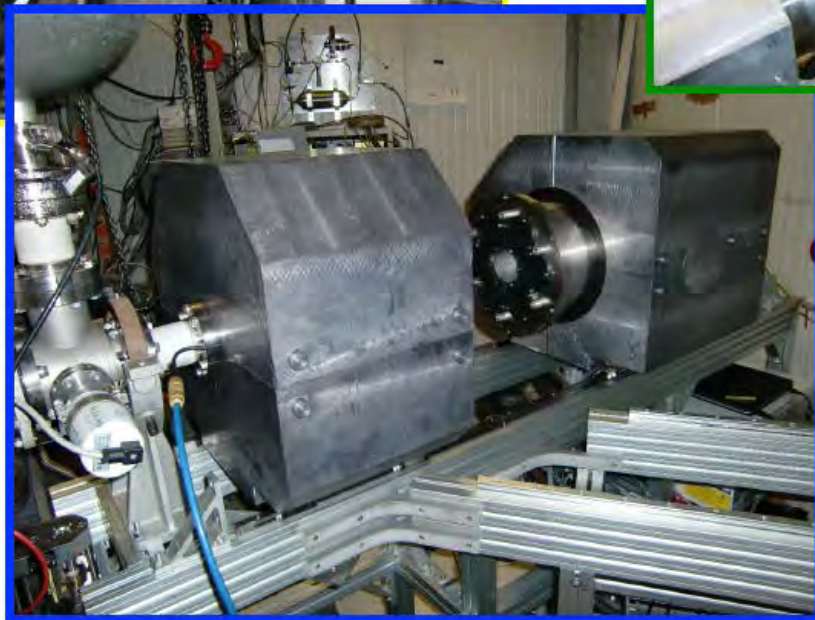

passive shielding
very effective underground
mainly at low γ -ray energies

higher γ -ray energies shielding
through rock overburden

courtesy A. Formicola

LUNA II – Key Studies

pp chain

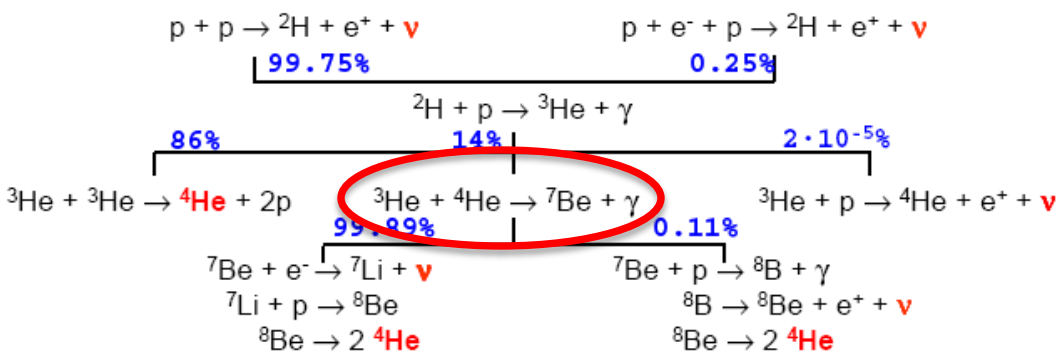

CNO cycle

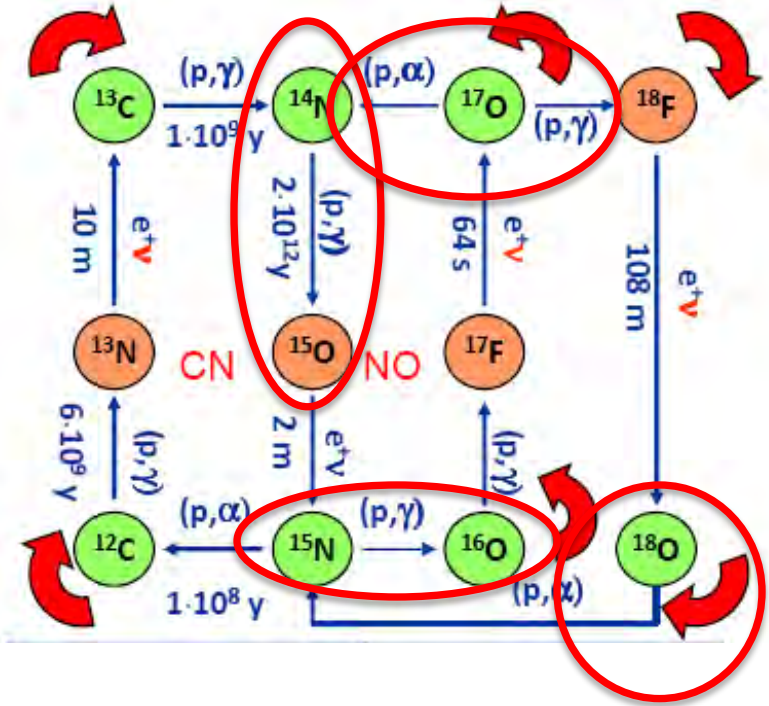

MgAl cycle

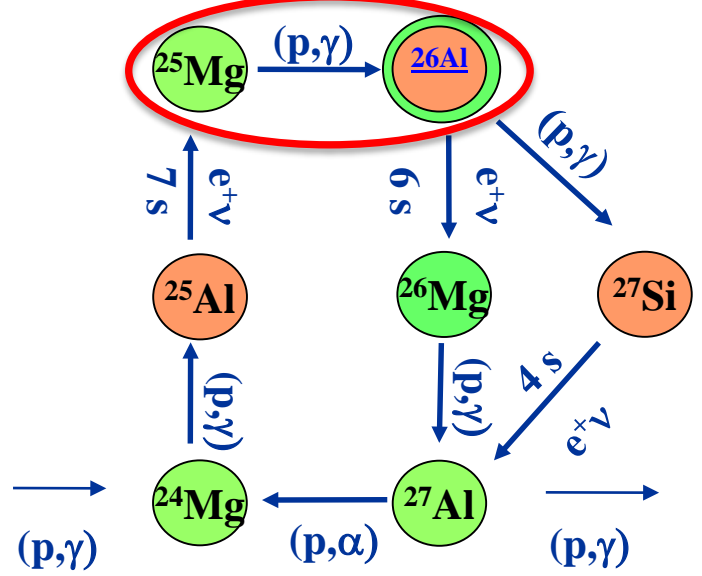

1.8 MeV ²⁶Al decay γ-ray line

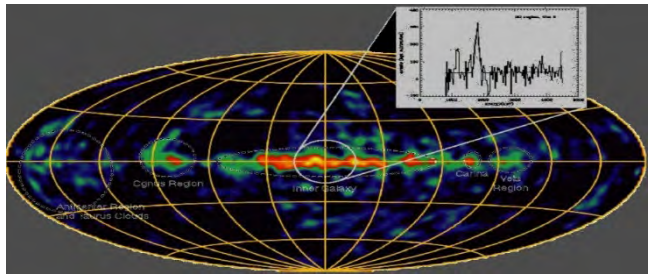

${}^3\text{He}(\alpha,\gamma){}^7\text{Be}$ – best example for combination of high and low energy data

now: very good R-Matrix fit over large energy region, but differences to models

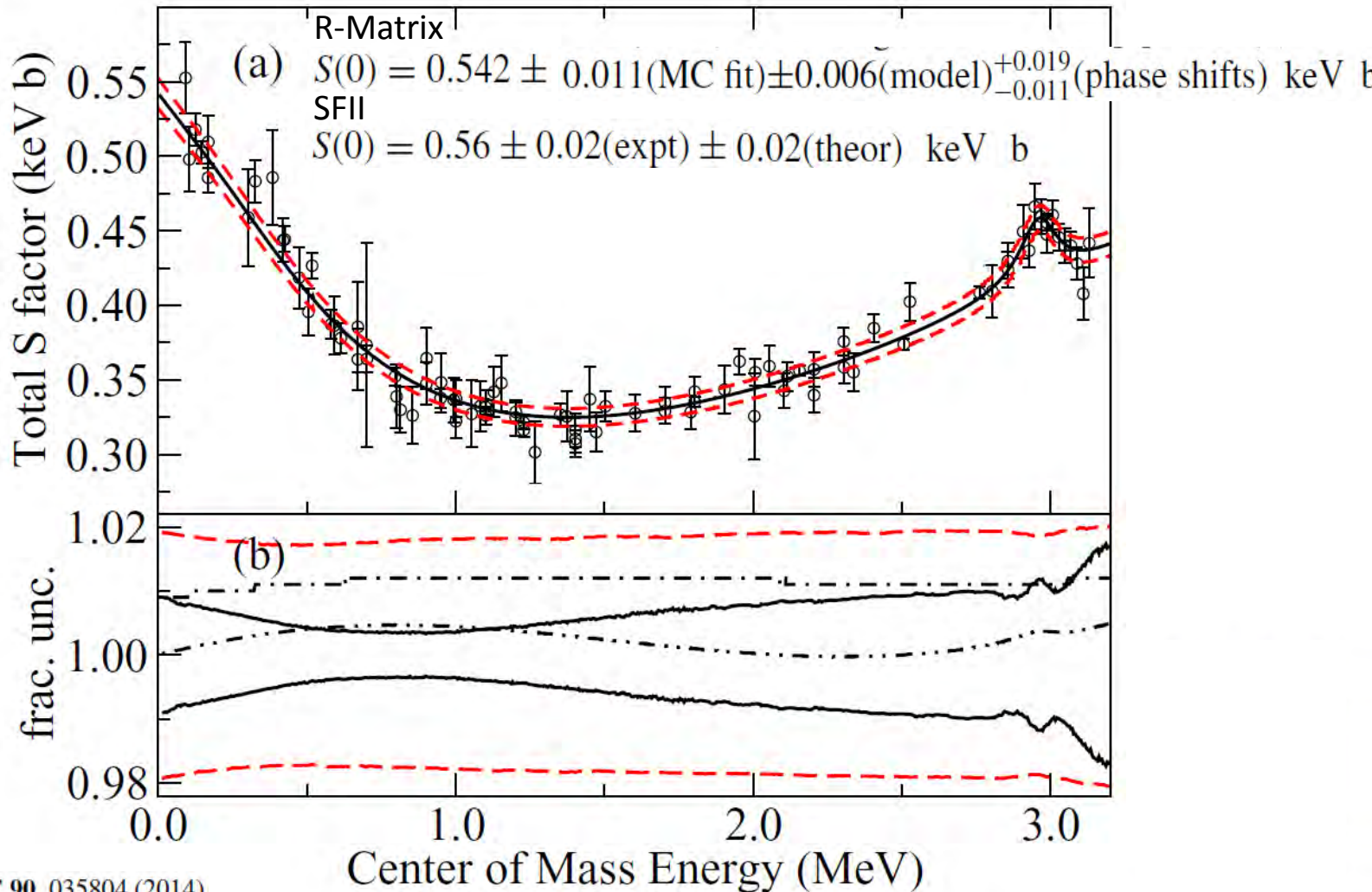

LUNA II – $^{14}\text{N}(p,\gamma)^{15}\text{O}$ CNO bottleneck reaction

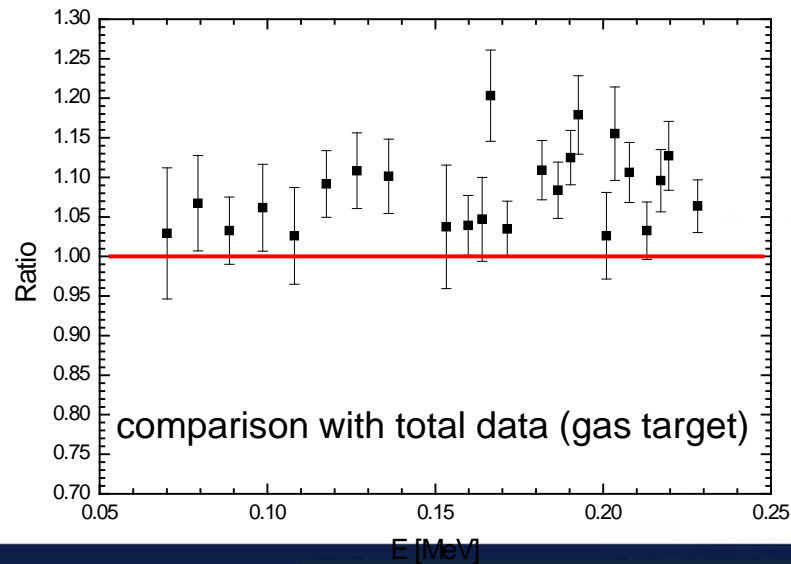
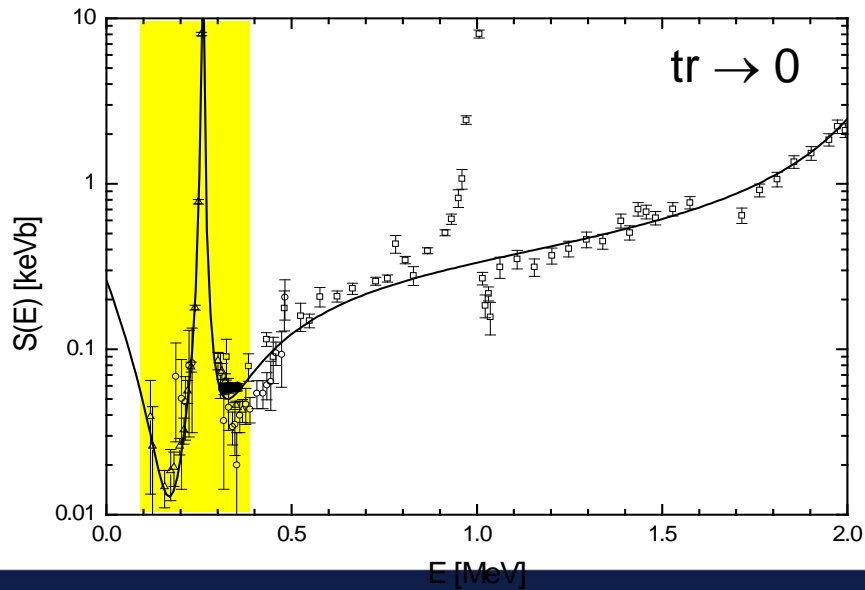
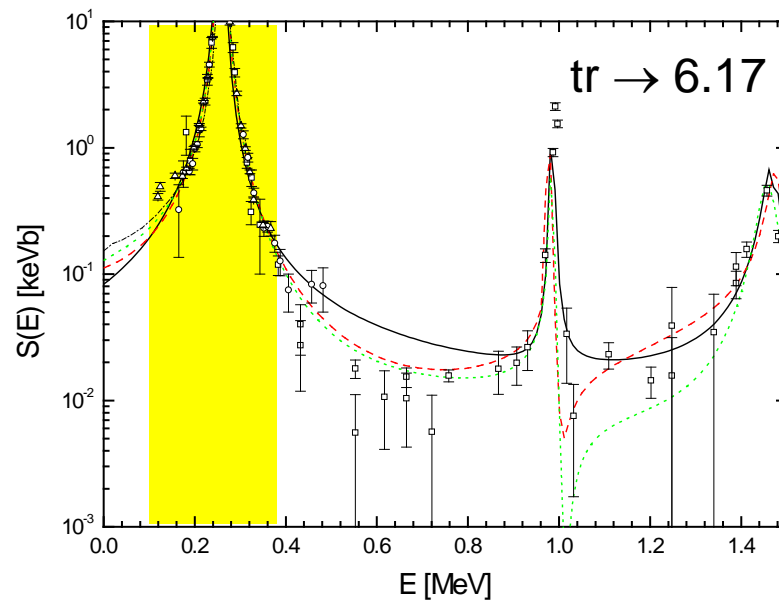
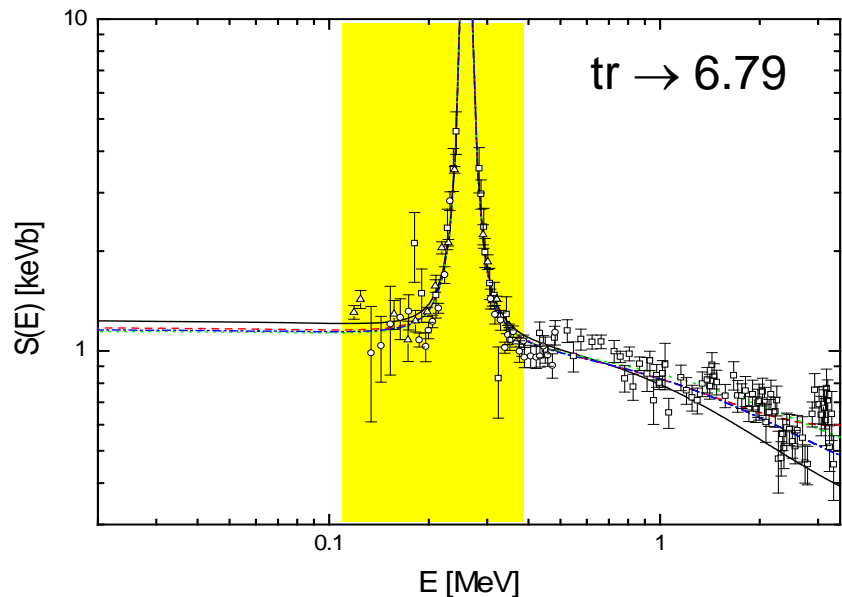

Compact **A**ccelerator **S**ystem for **P**erforming **A**strophysical **R**esearch



Frank Strieder (PI)
Doug Wells
Tyler Borgwardt
Mark Hanhardt
Thomas Kadlecik
Joe VanDriel
John Harrison
Lucas Lindholm



Dan Robertson (TC)
Manoel Couder
Michael Wiescher
Rory Hamilton
Zach Meisel
Bryant Vande Kolk



Uwe Greife

SURF
Lead, South Dakota



Sanford Underground Research Facility

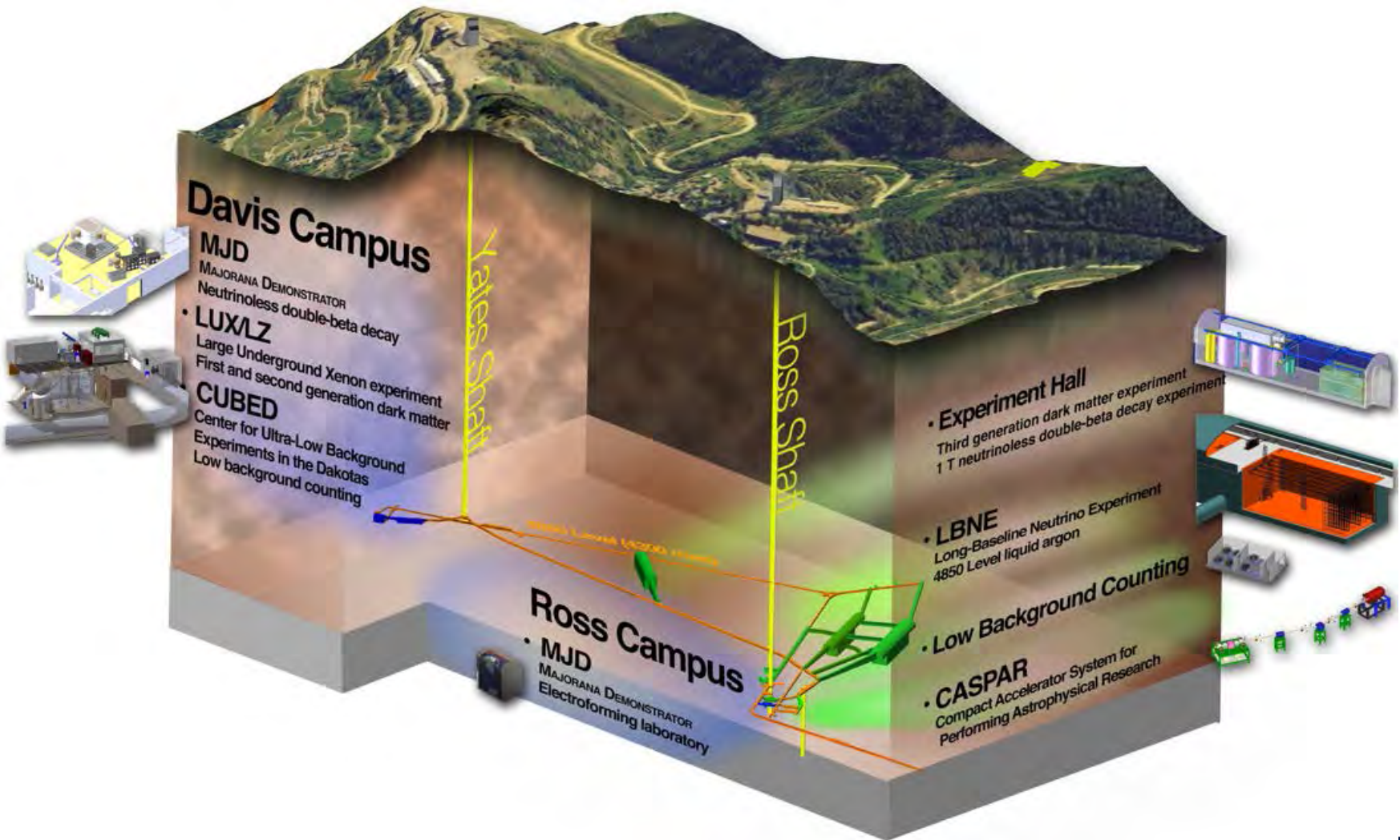

SURF 4850 L Ross Campus

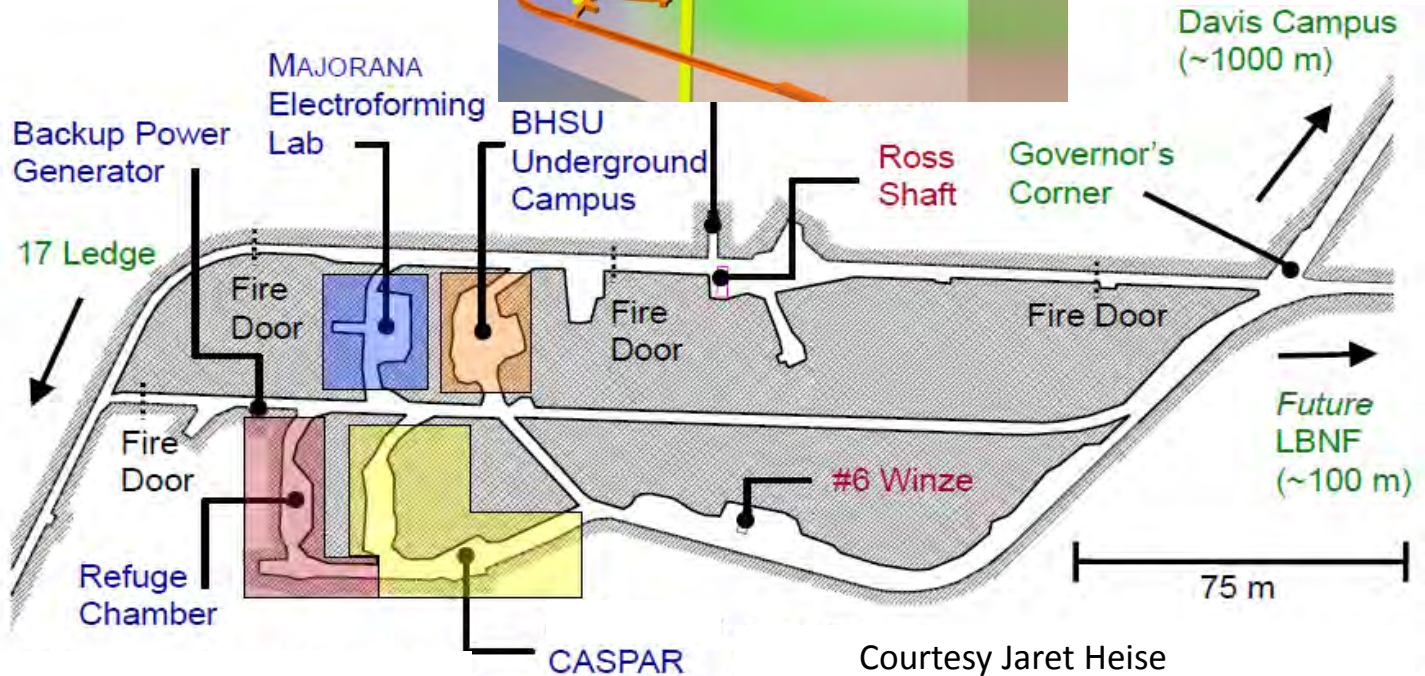
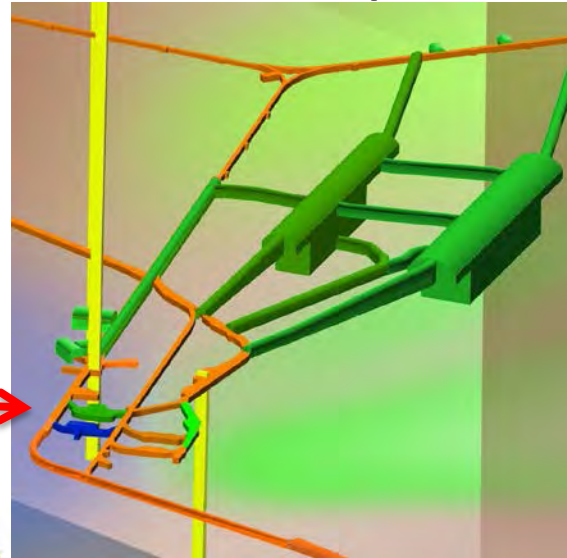
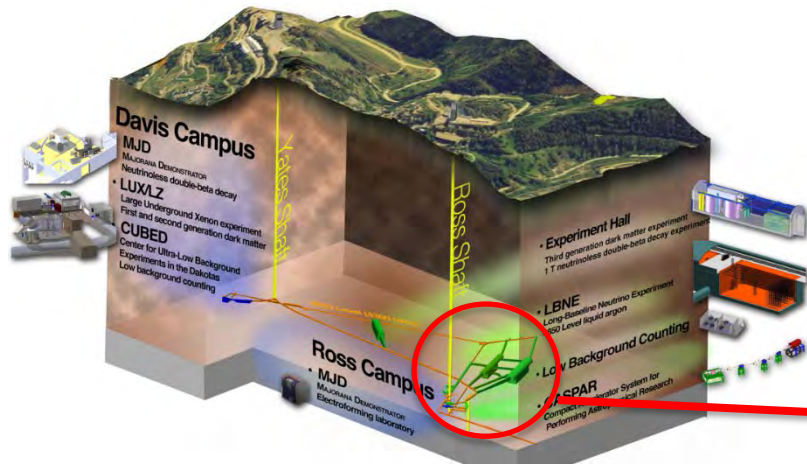



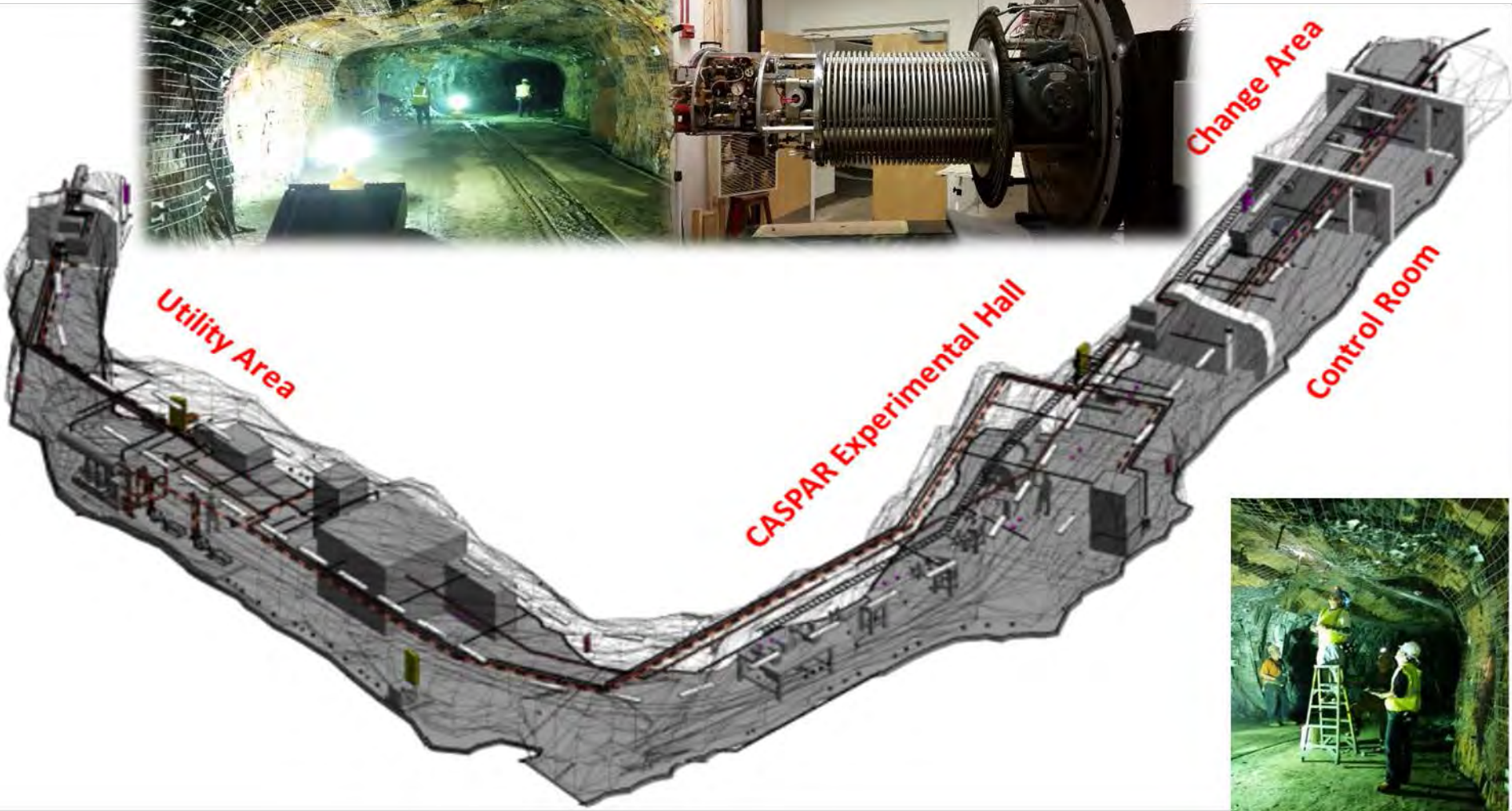

How were Elements from Iron to Uranium made?

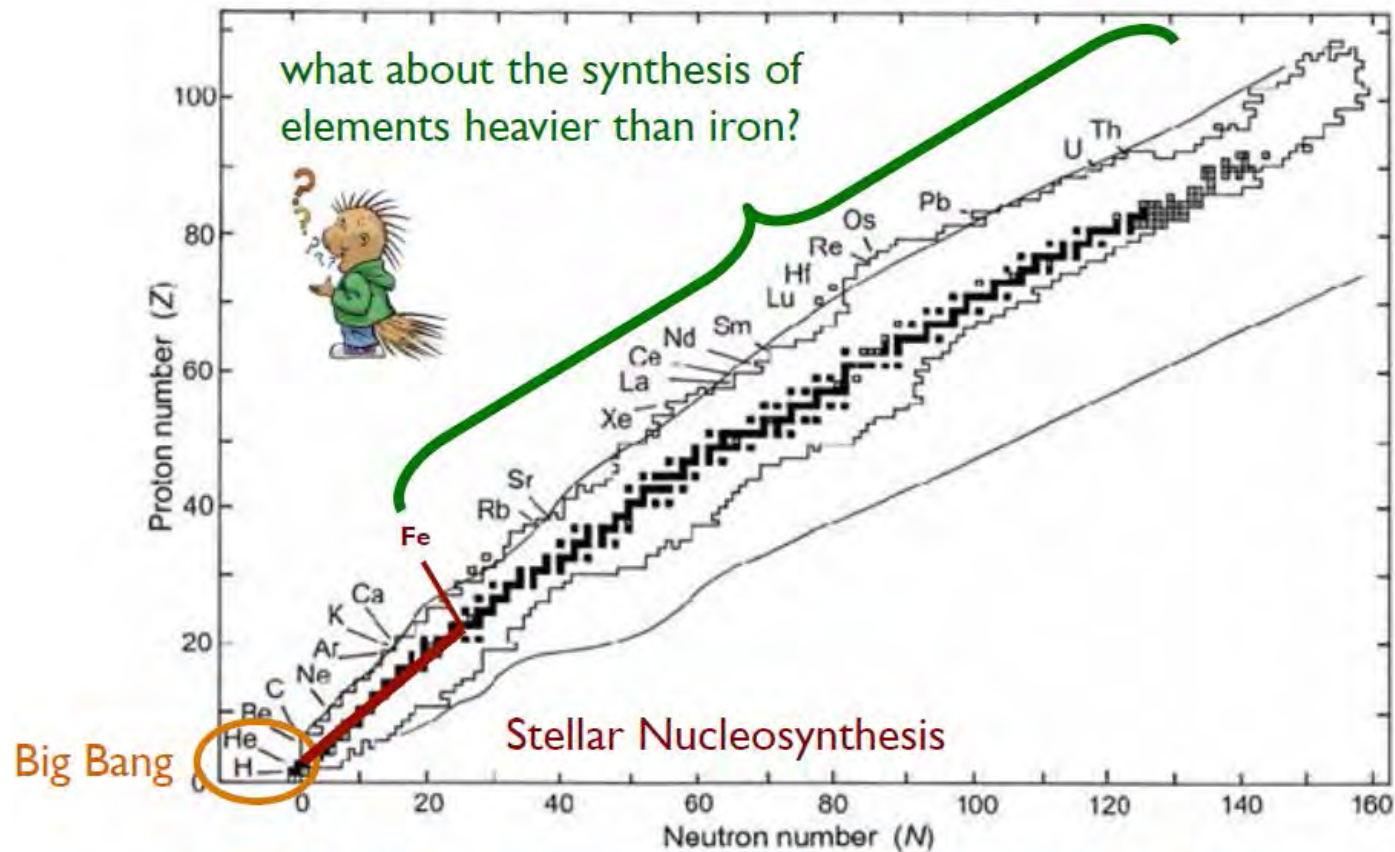

“The 11 Greatest Unanswered Questions of Physics”
from: National Academy of Science Report, 2002

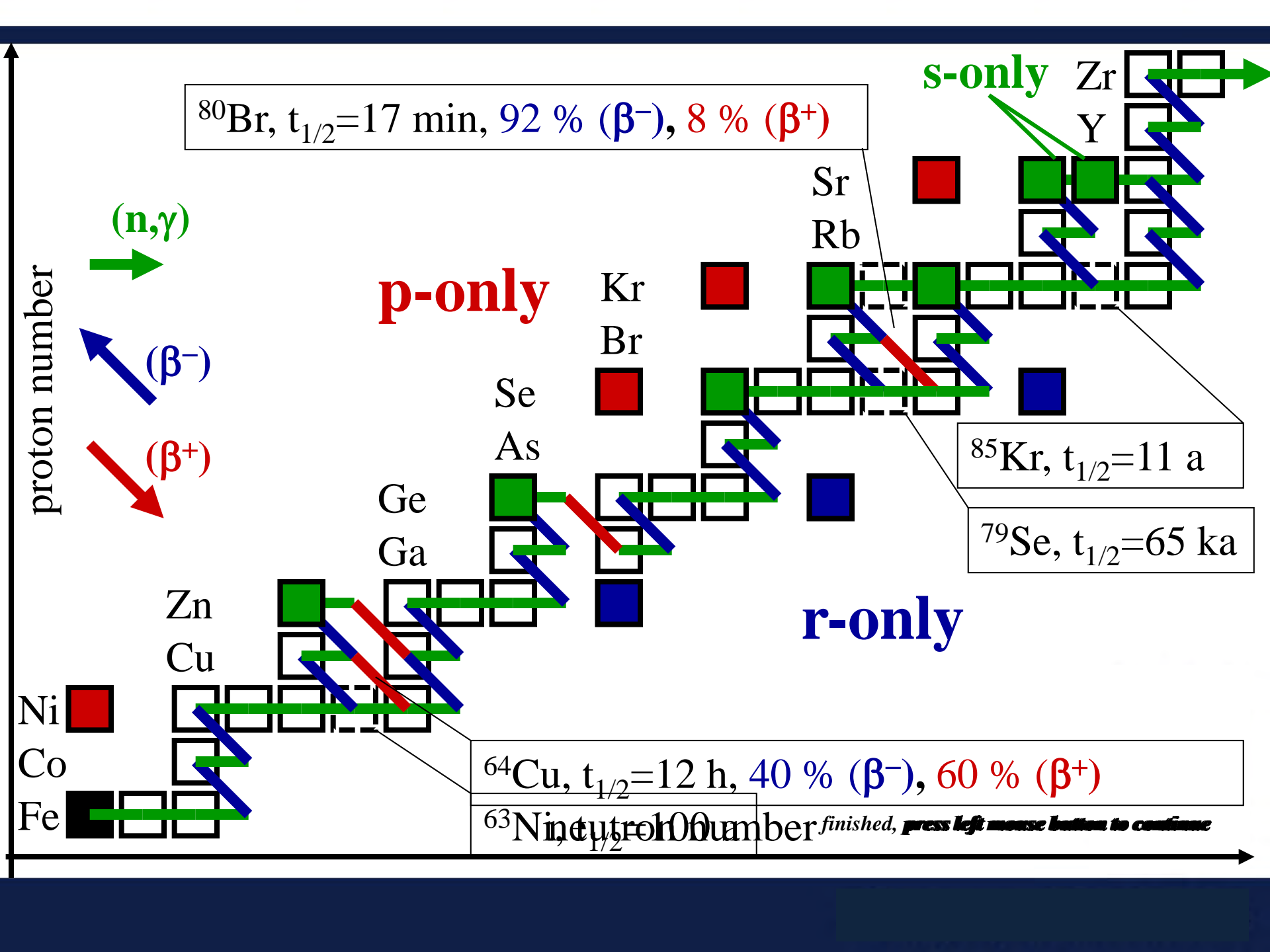

CASPAR Concept

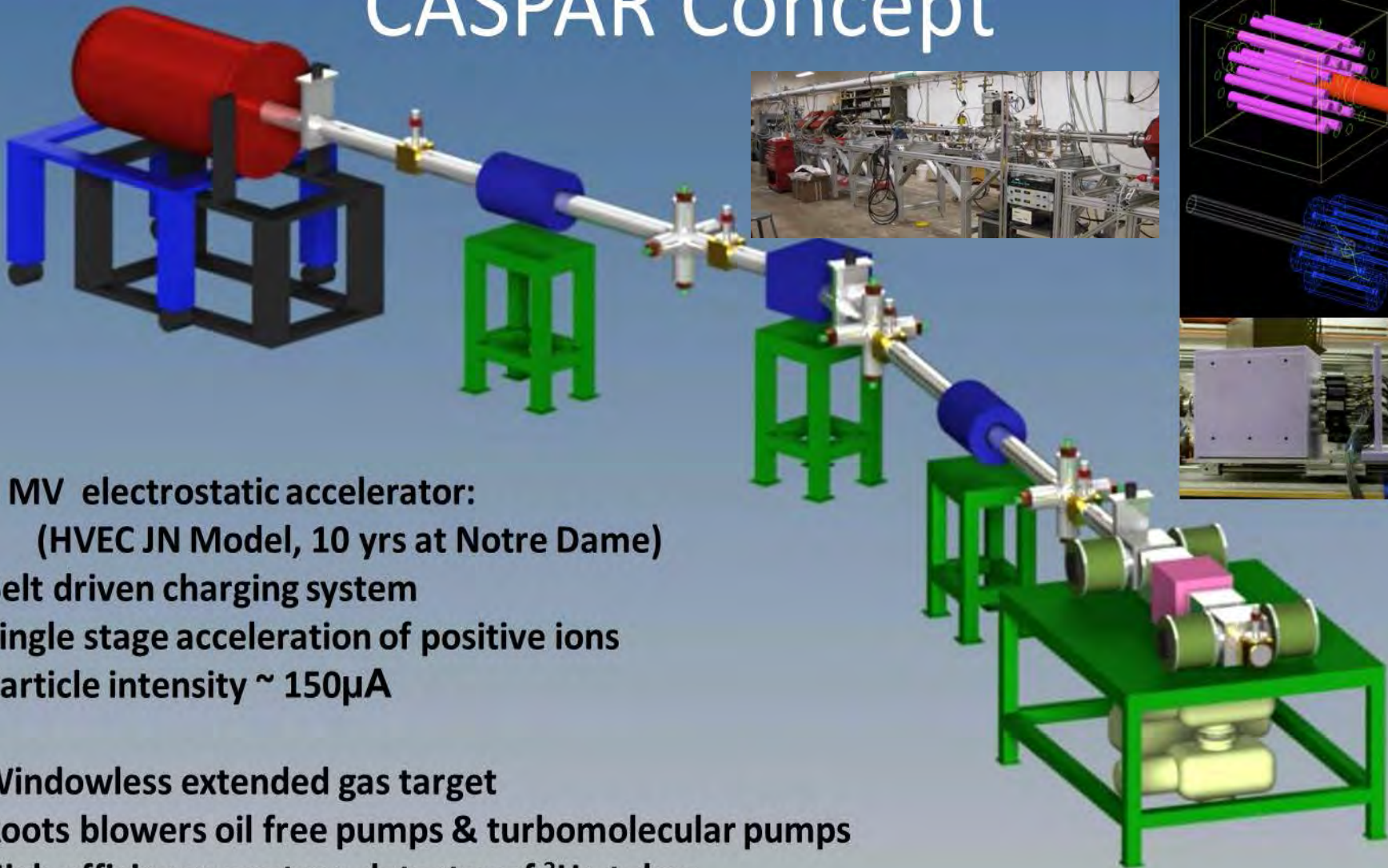

**1 MV electrostatic accelerator:
(HVEC JN Model, 10 yrs at Notre Dame)**

Belt driven charging system

Single stage acceleration of positive ions

Particle intensity $\sim 150\mu\text{A}$

Windowless extended gas target

Roots blowers oil free pumps & turbomolecular pumps

High efficiency neutron detector of ^3He tubes

October 6th, 2015



Photo by Matt Kapust (SURF)

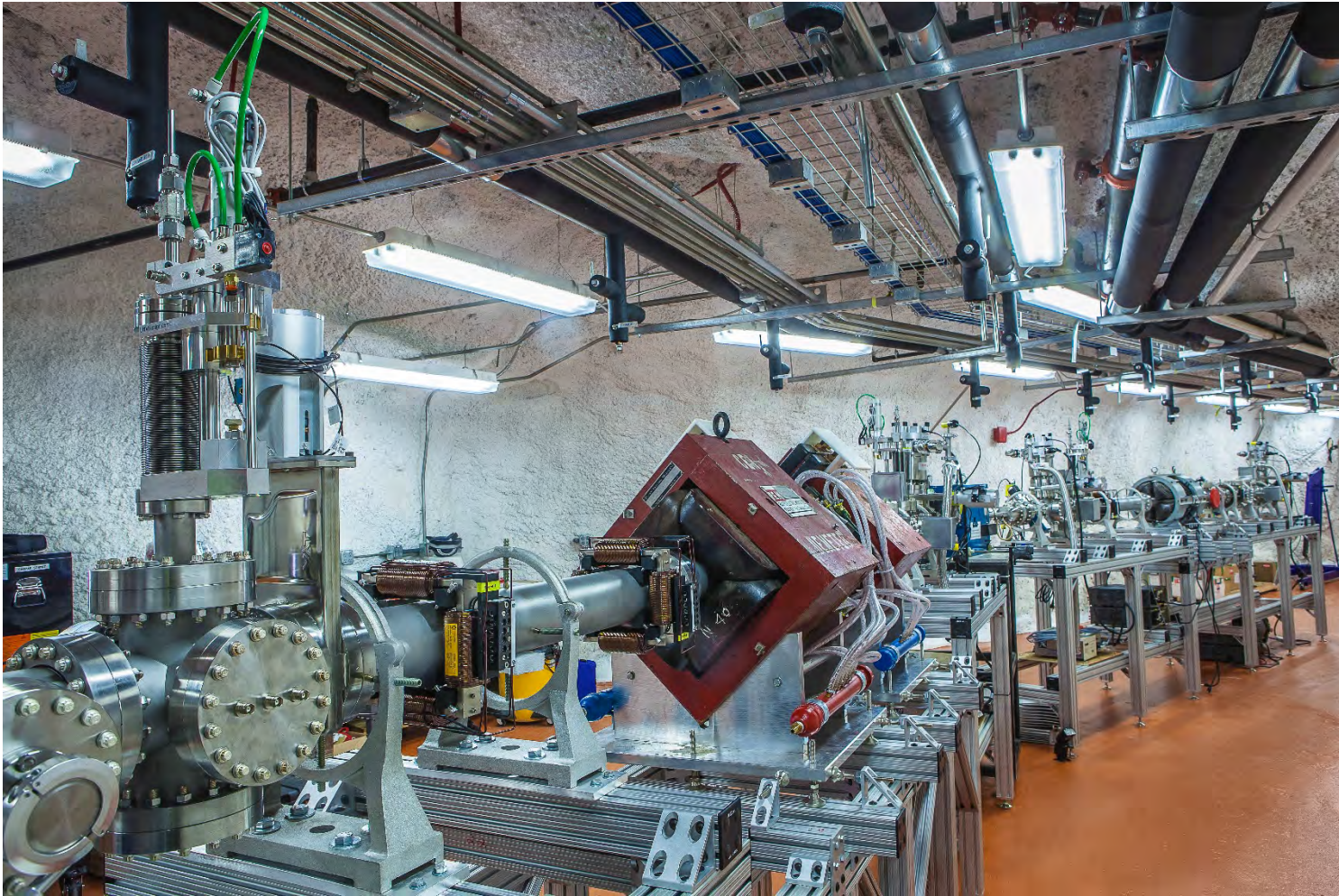
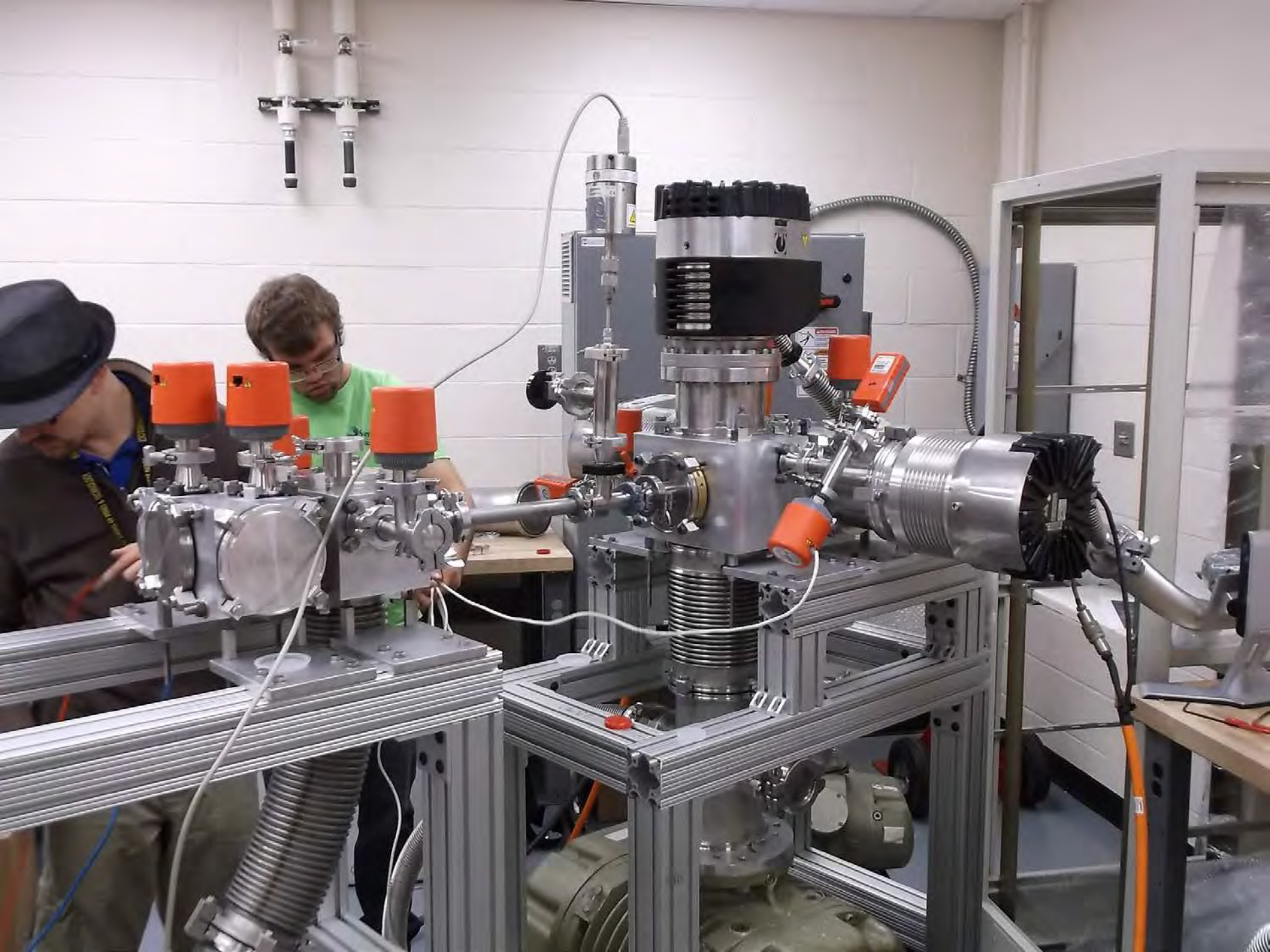
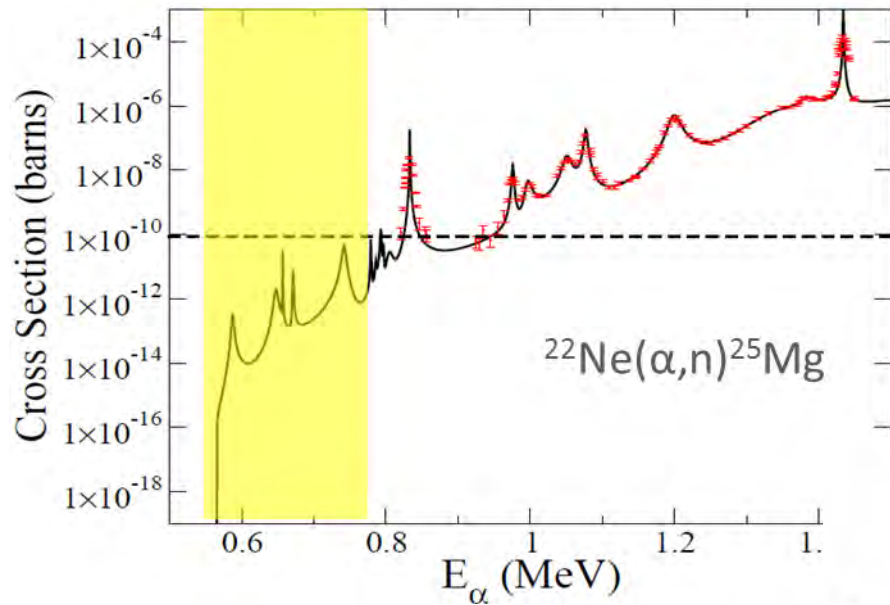

Photo by Matt Kapust (SURF)





Seeds for the s-process



- $^{22}\text{Ne}(\alpha,n)^{25}\text{Mg}$ and $^{13}\text{C}(\alpha,n)^{16}\text{O}$
- Neutron sources for the s-process
- Large Uncertainties in astrophysical energy region
- Measurements limited by cosmic-ray induced background

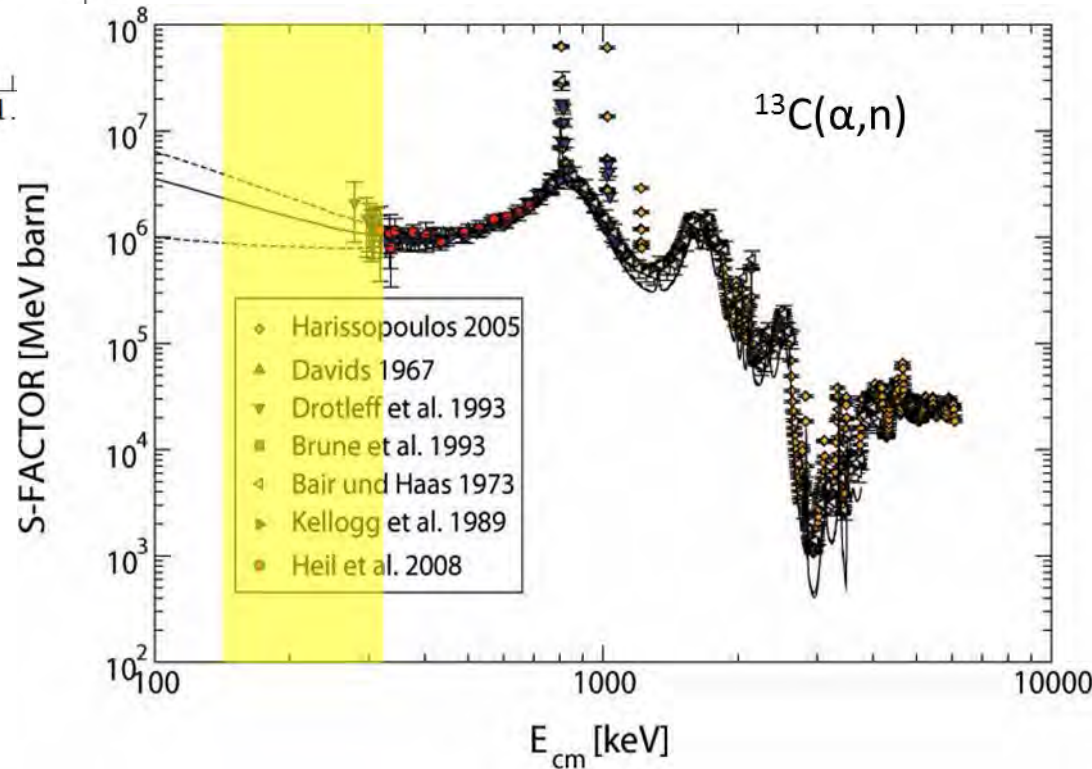

Neutron Background Reduction

^3He proportional counter in
a polyethylene moderator matrix

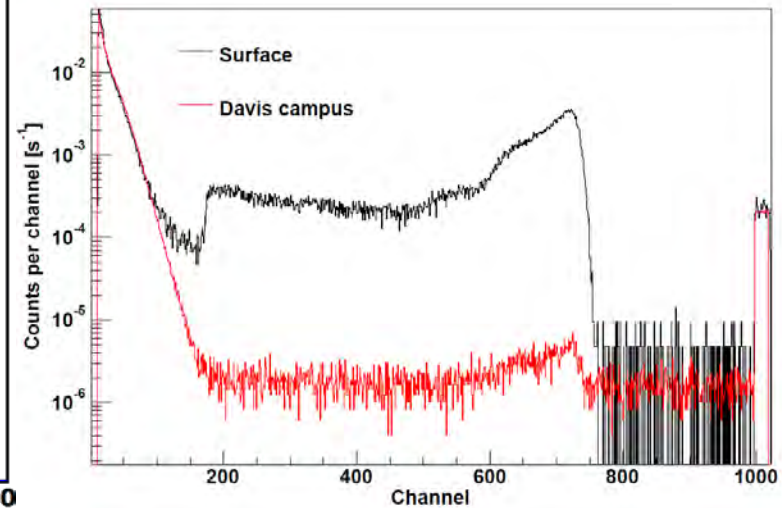
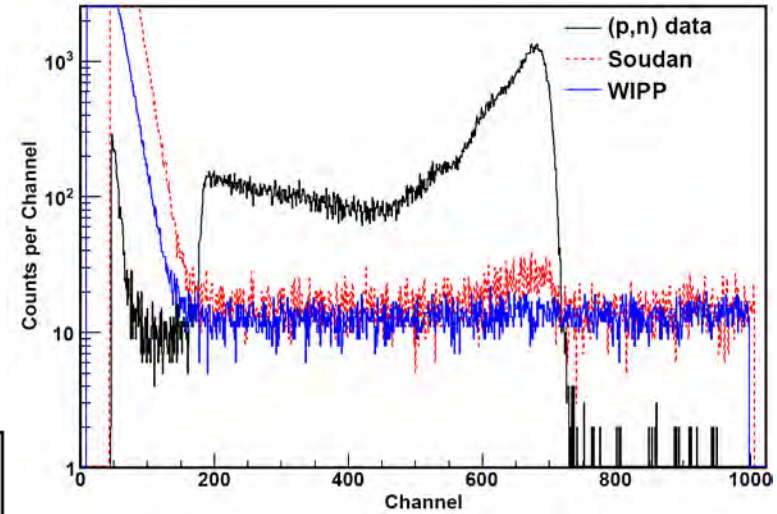
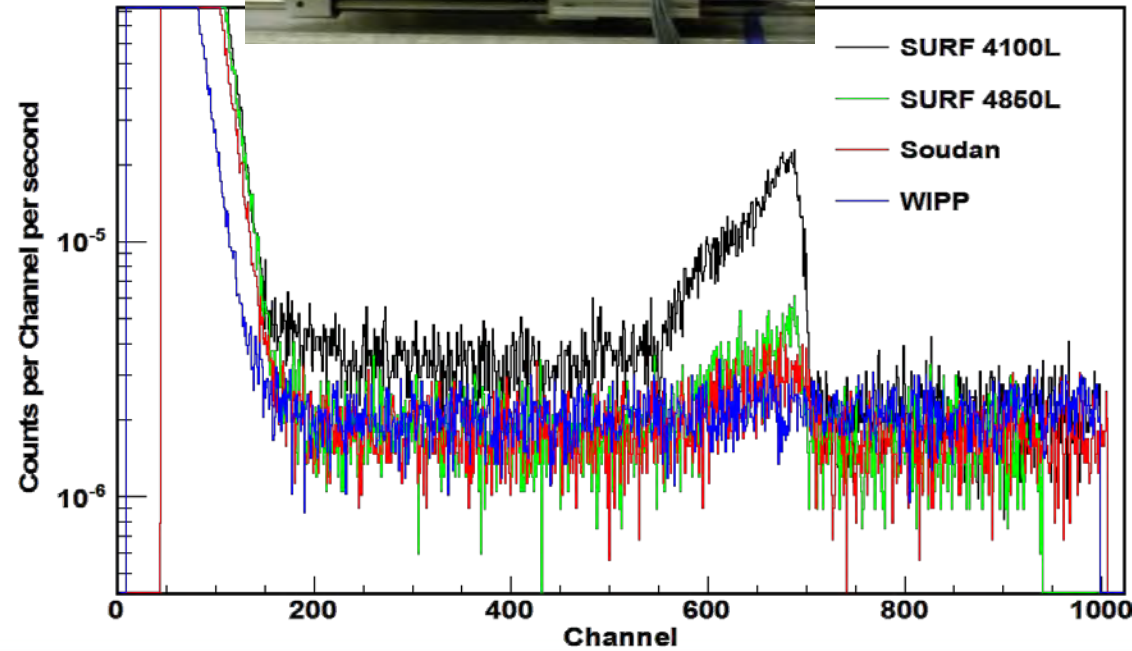
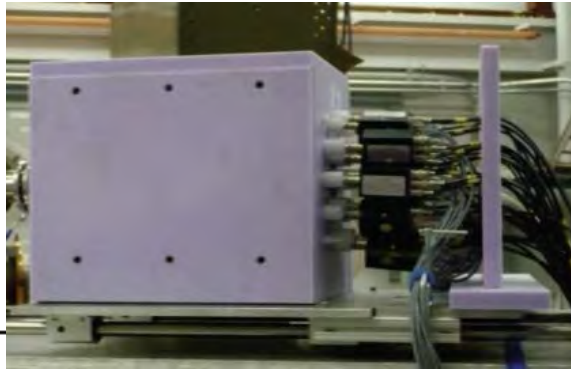

Future Underground Nuclear Astrophysics

Status of the LUNA-MV project at LNGS

Accelerator:

Intense H^+ , $^4He^+$, $^{12}C^+$ e $^{12}C^{++}$ beams in the energy range: 350 keV-3.5 MeV. One beam line with all necessary elements (magnets, pumps, valves,...).

Total budget about 3.9 Meuro: from LUNA MV Premium projects (total 5.3 Meuro)

Tendering procedure: full documentation submitted to INFN central administration at end of february 2015.

Accelerator installed and tested at LNGS by 07/2018. Then first experiments

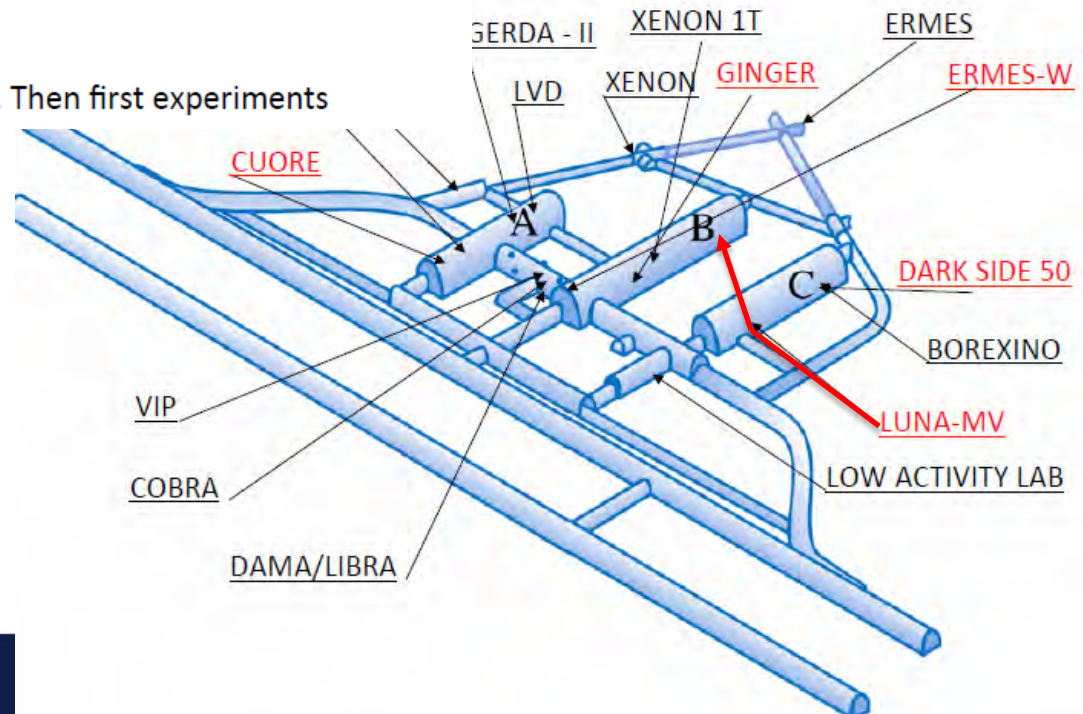

LUNA-MV Physics - $^{12}\text{C}(\alpha,\gamma)^{16}\text{O}$ more than 40 years

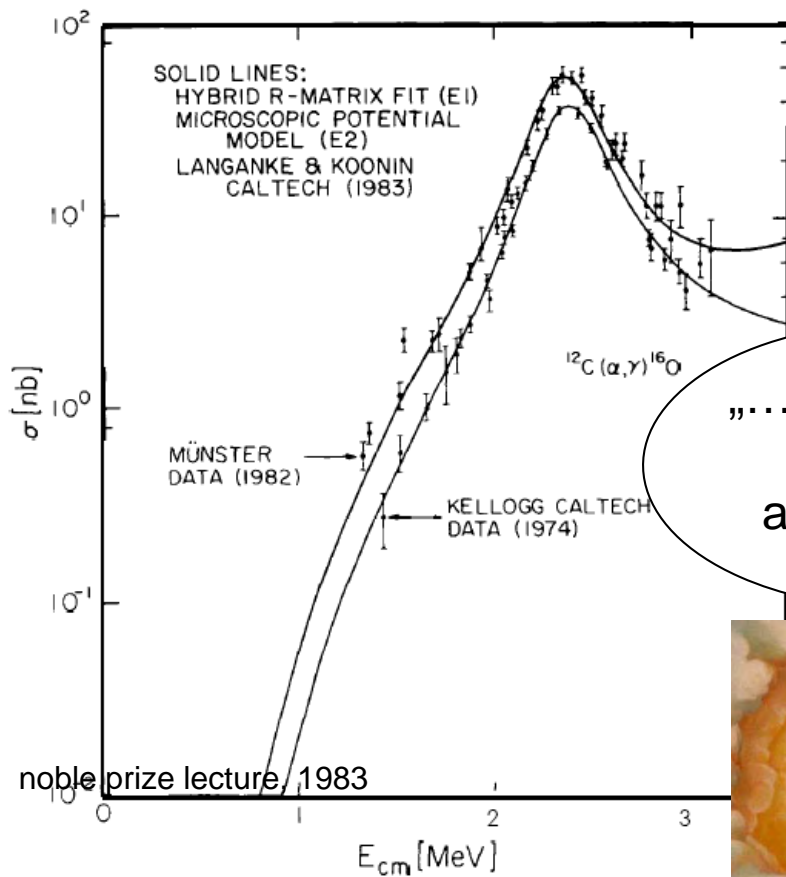

William A. Fowler (1911 – 1995)

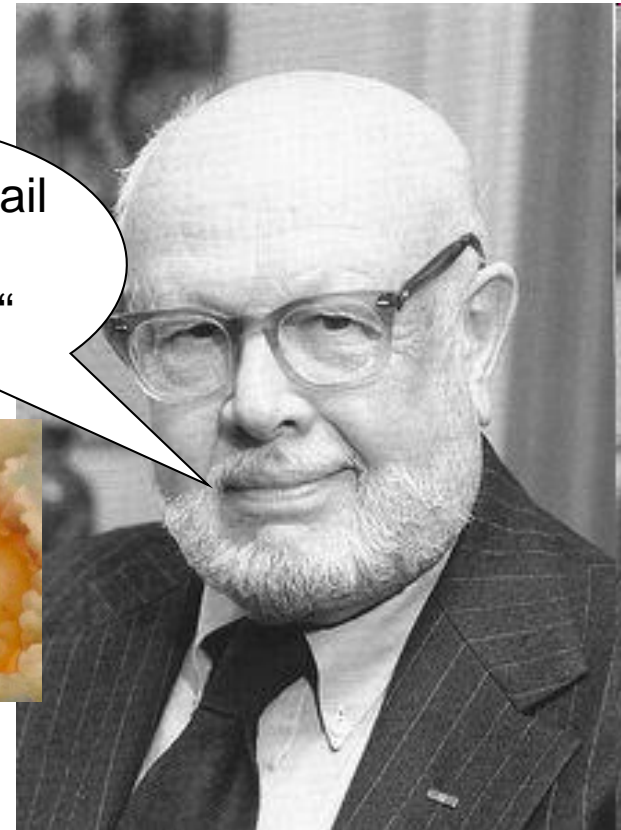

„... the holy grail
of nuclear
astrophysics“



Nobel Prize for Physics (1983)
for „his theoretical and experimental studies of the
nuclear reactions of importance in the formation of
the chemical elements in the universe“.

(shared with S. Chandrasekhar)

Direct Methods – γ -ray Experiments

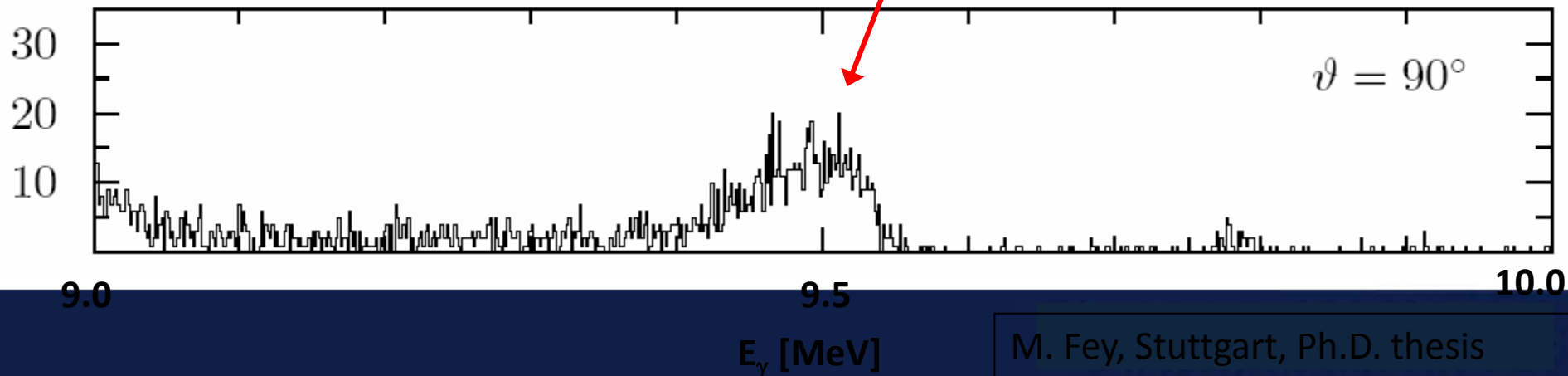
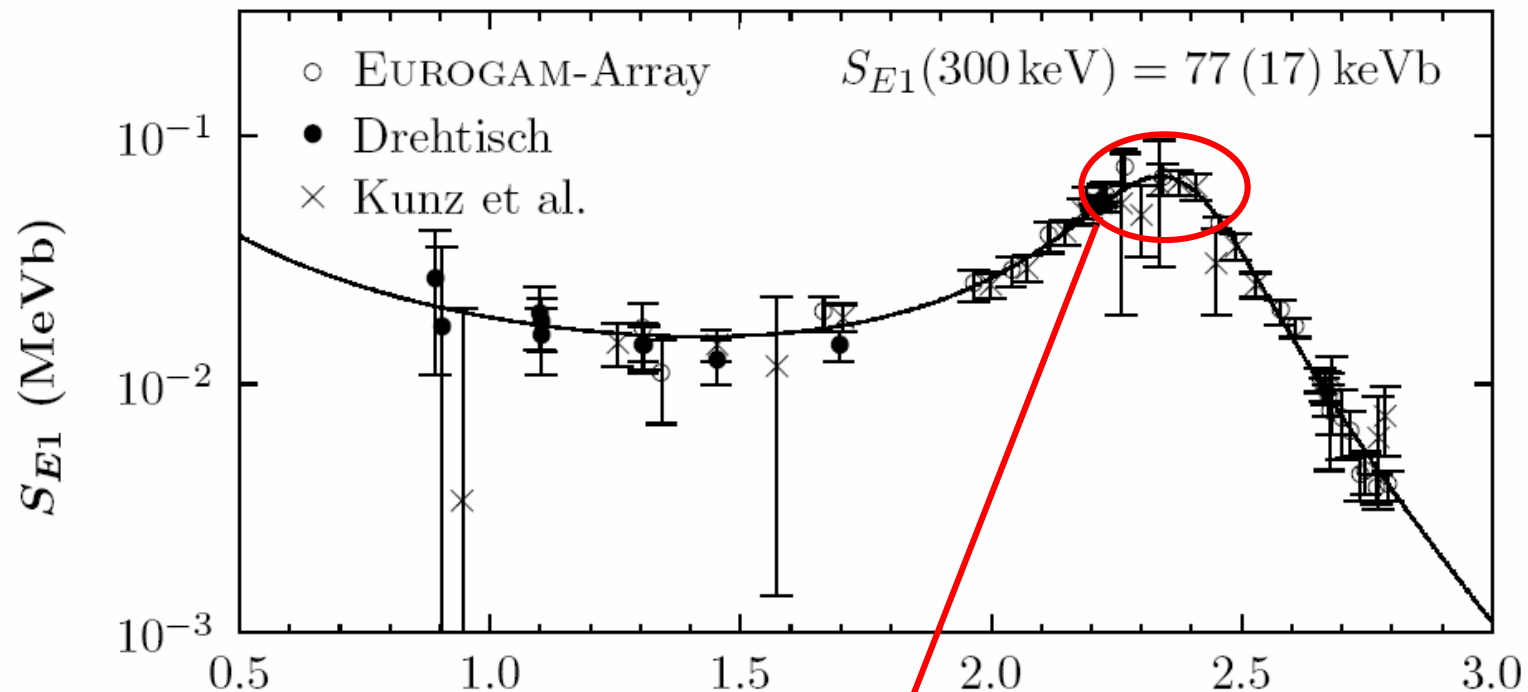

Direct Methods – γ -ray Experiments

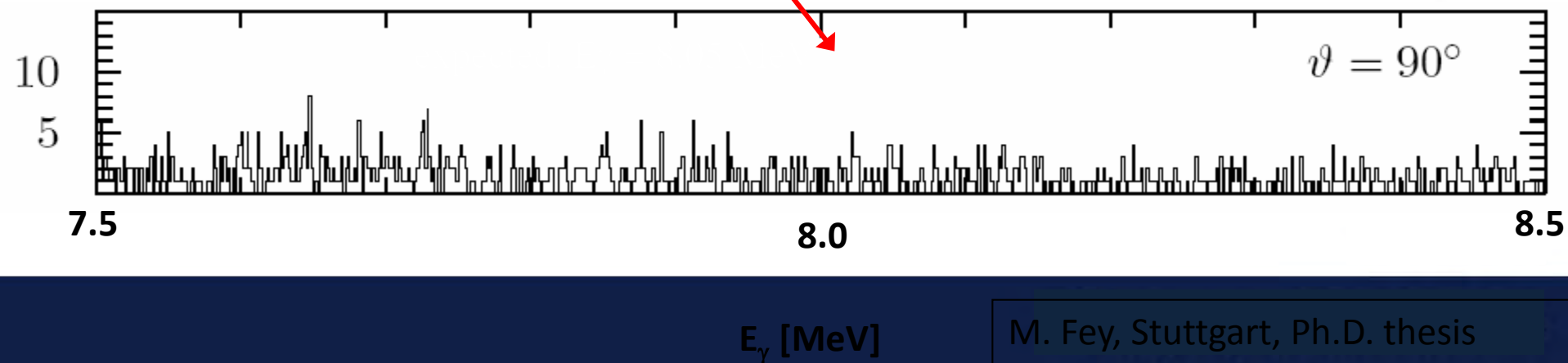
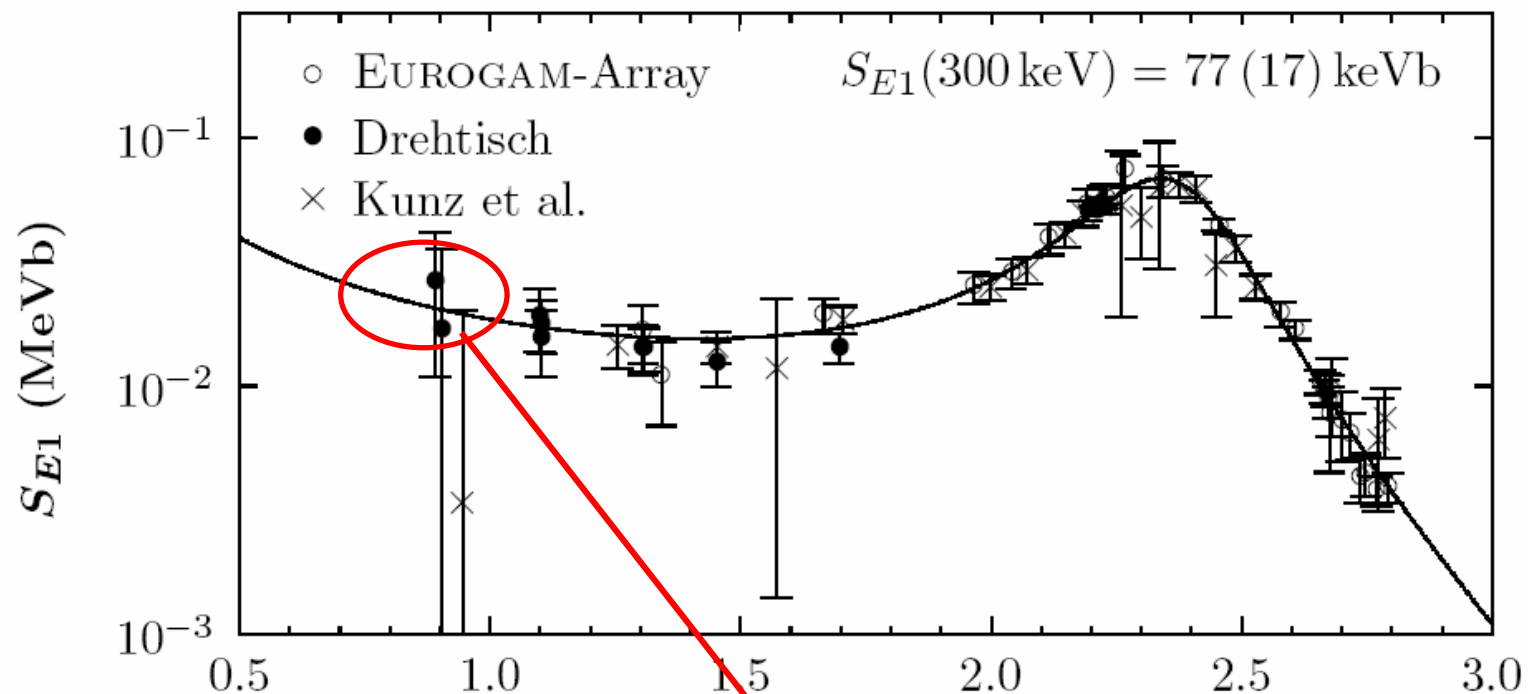

$^{12}\text{C}(\alpha,\gamma)^{16}\text{O}$ – Aims LUNA-MV/ERNA

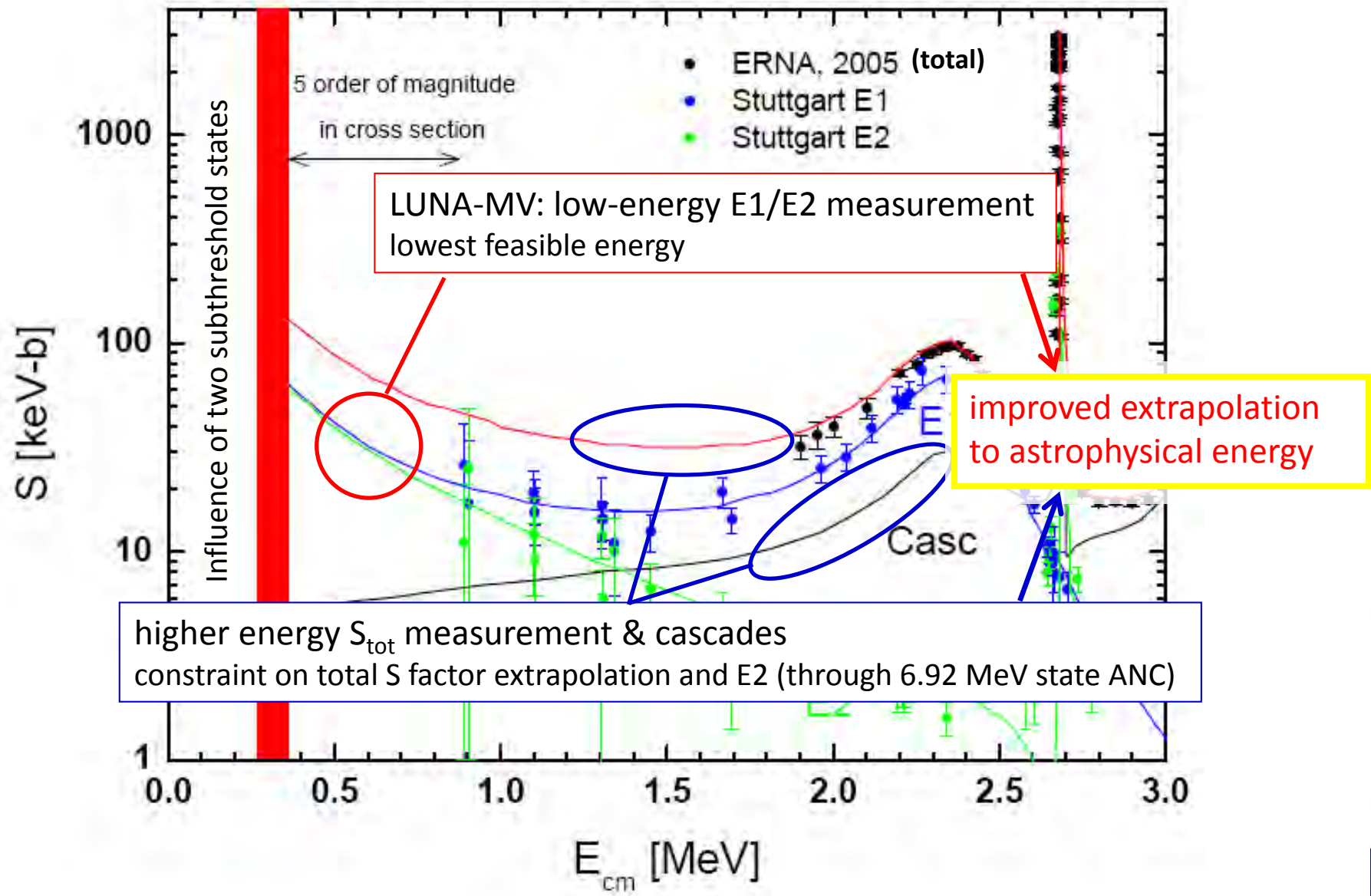

$^{12}\text{C}(\alpha, \gamma)^{16}\text{O}$ – Experimental Issues



GEANT4 simulation of γ -ray array
example: GASP 4 π BGO array

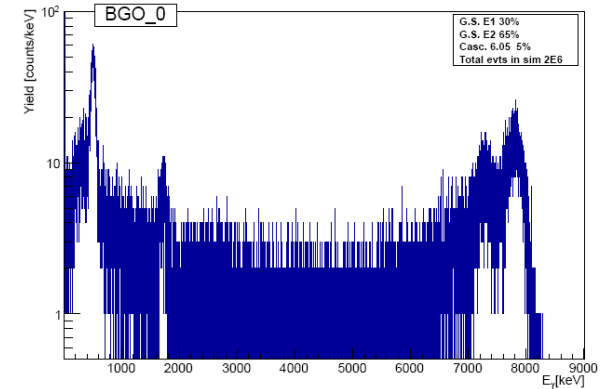

^{12}C target preparation at SIDONI (France)
contact established
preliminary studies in progress

target characterization at LNL
test studies in progress

higher separation power

high homogeneity

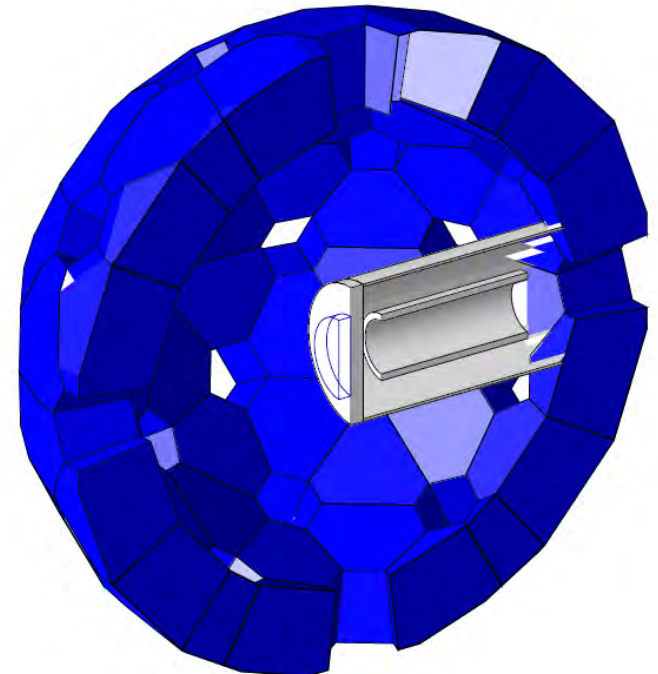
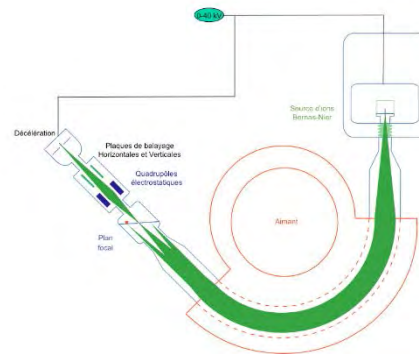
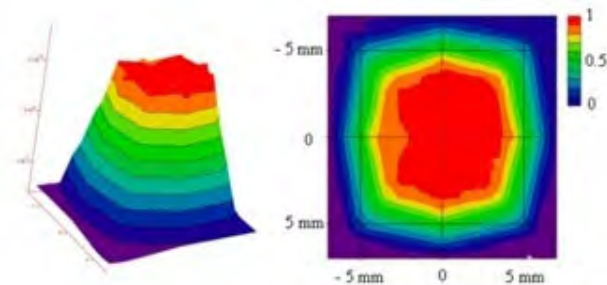

CJPL underground laboratory

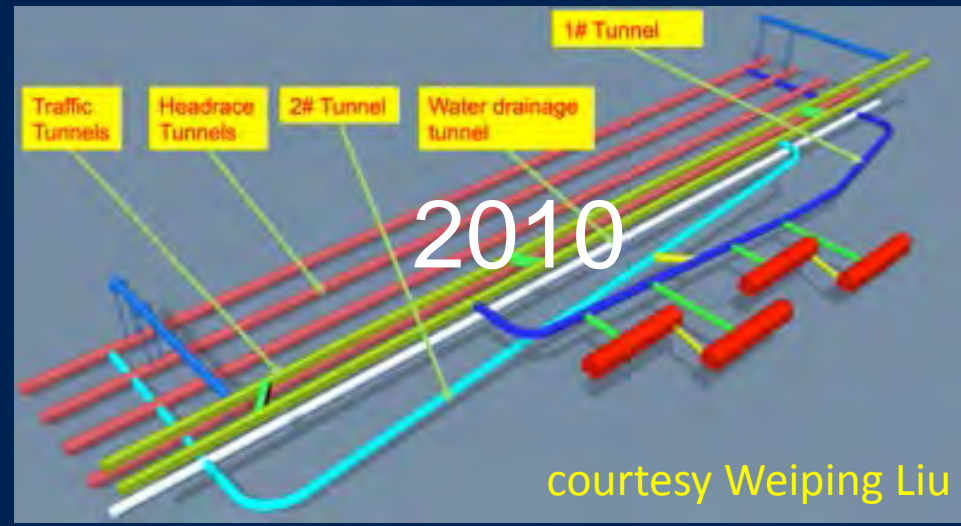
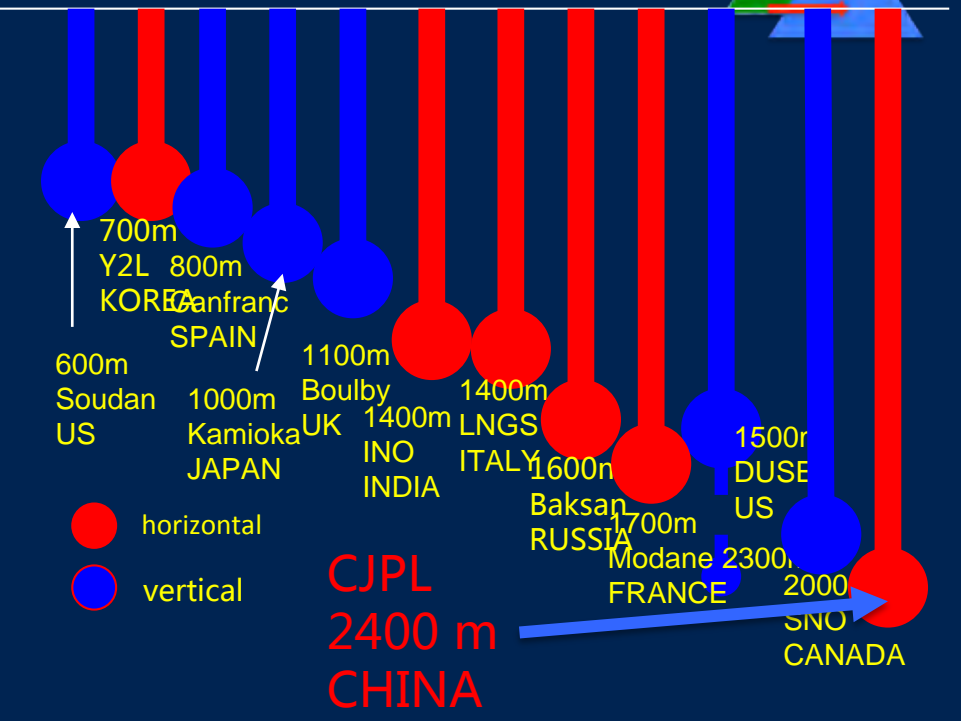
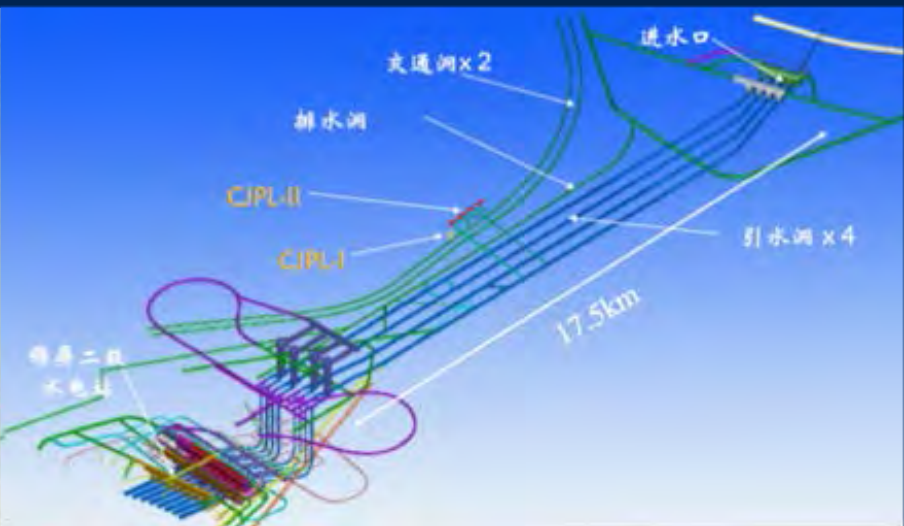

JUNA-I plan

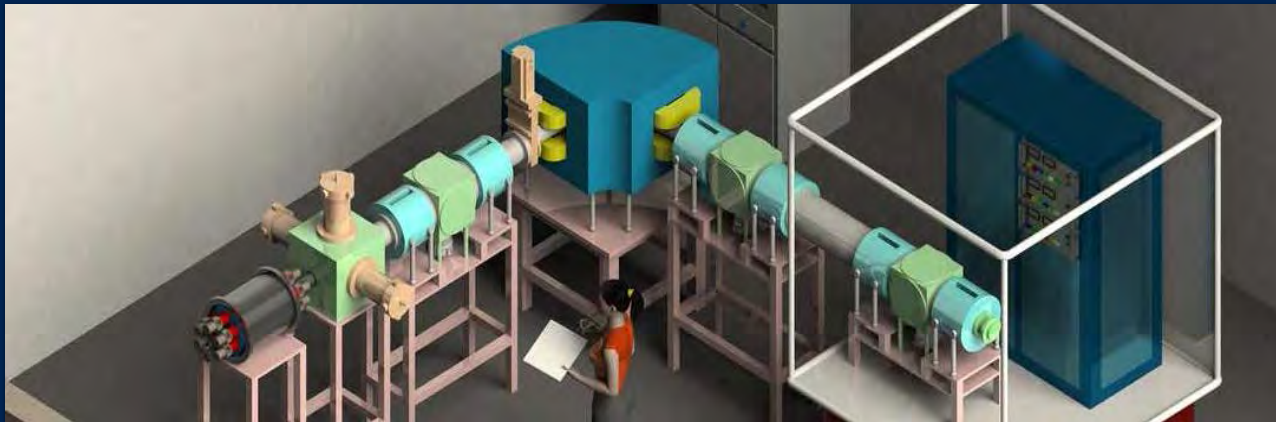

JUNA-I

<i>Beam</i>	<i>Intensity (mA)</i>	<i>Energy,keV</i>
H ⁺	10	70-400
He ⁺	10	70-400
He ⁺⁺	2-5	140-800

CJPL-II progress

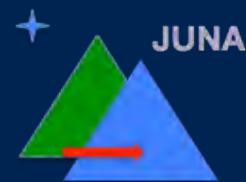

courtesy Weiping Liu



Underground accelerator project DIANA for low energy studies

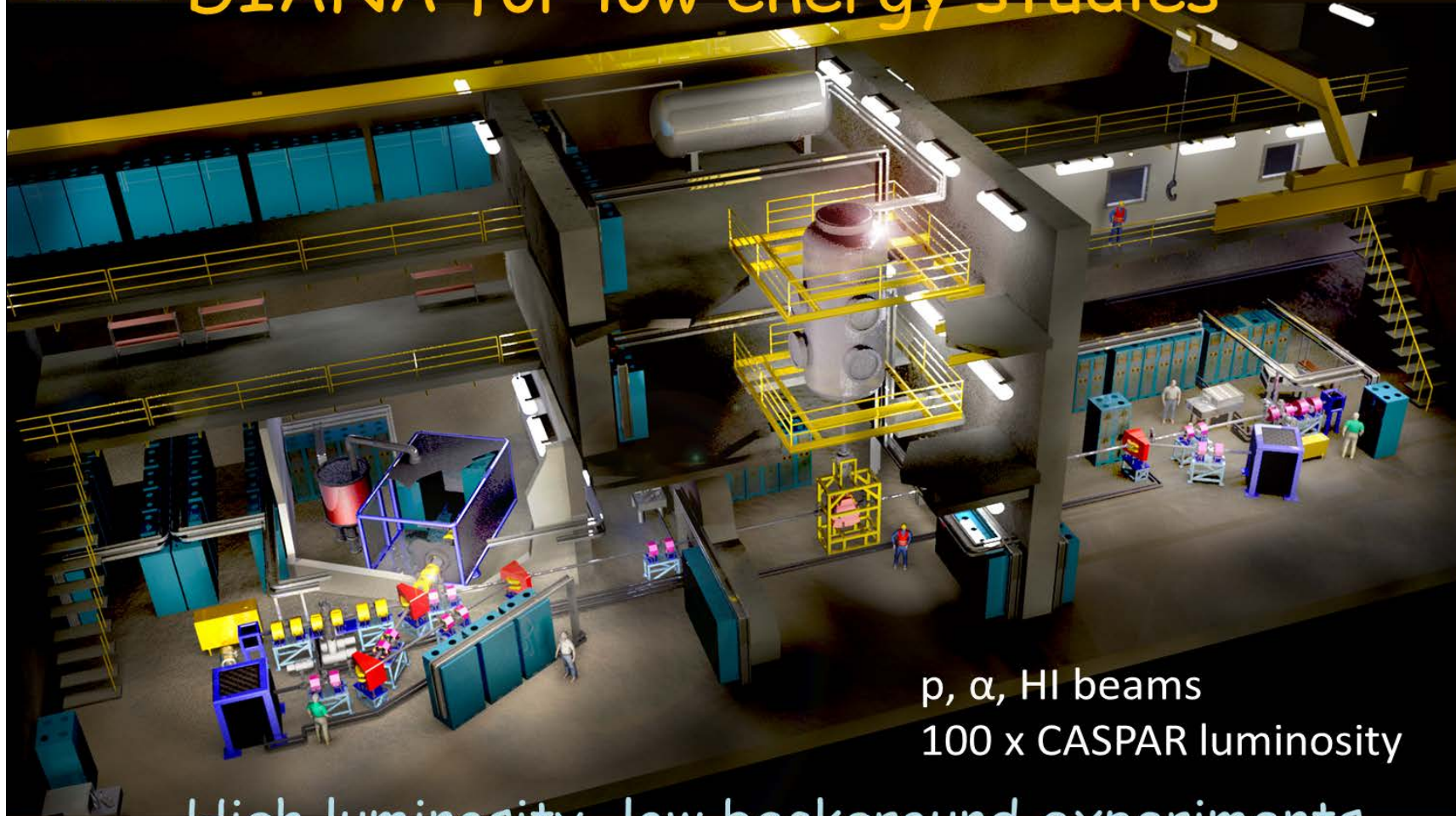

p, α , HI beams
100 x CASPAR luminosity

High luminosity, low background experiments