



WA105/ProtoDUNE-DP

Charge Readout Plane Assembly and Transport Box

WA105 Technical board– 15th of February 2017

*B. Aimard, N. Allemandou, M. Cailles, G. Deleglise, D. Duchesneau,
N. Geffroy, Y. Karyotakis, T. Yildizkaya*



Supporting structure

- Supporting structure is also :
 - *The Top of the Transport Box*
 - *The Crane in the clean room*
 - *The Scaffolding to access the center of the module during assembly*

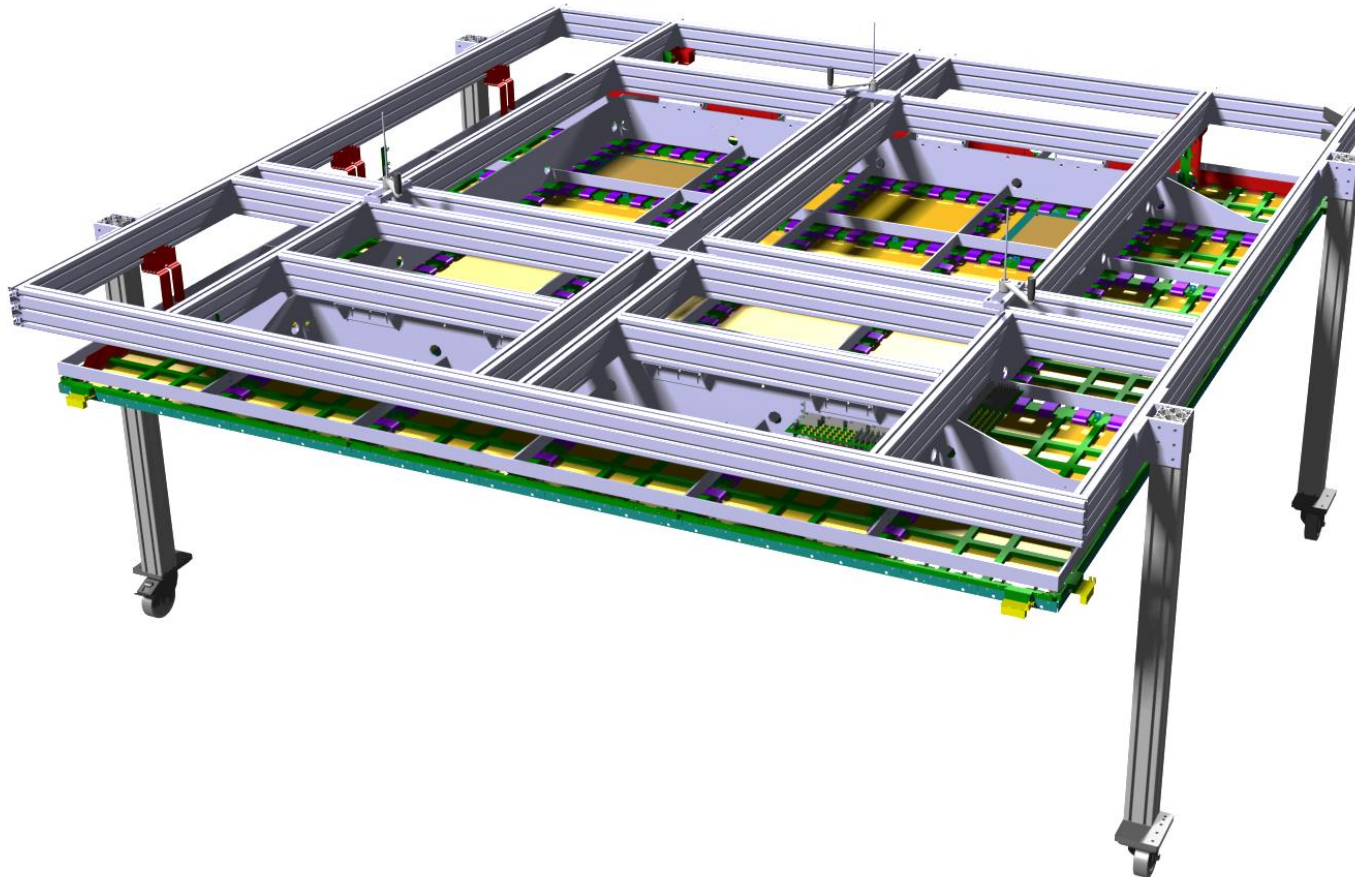

Supporting structure

- It features :
 - *Very stiff shape to avoid any CRP deformation during transport*
 - *Special cranks to rise accurately the CRP during assembly*
 - *Special shape to be easily removed inside of the cryostat*
 - *Solid anchoring systems on one side for insertion in the cryostat*
 - *Bottom of the box can be added between foot*

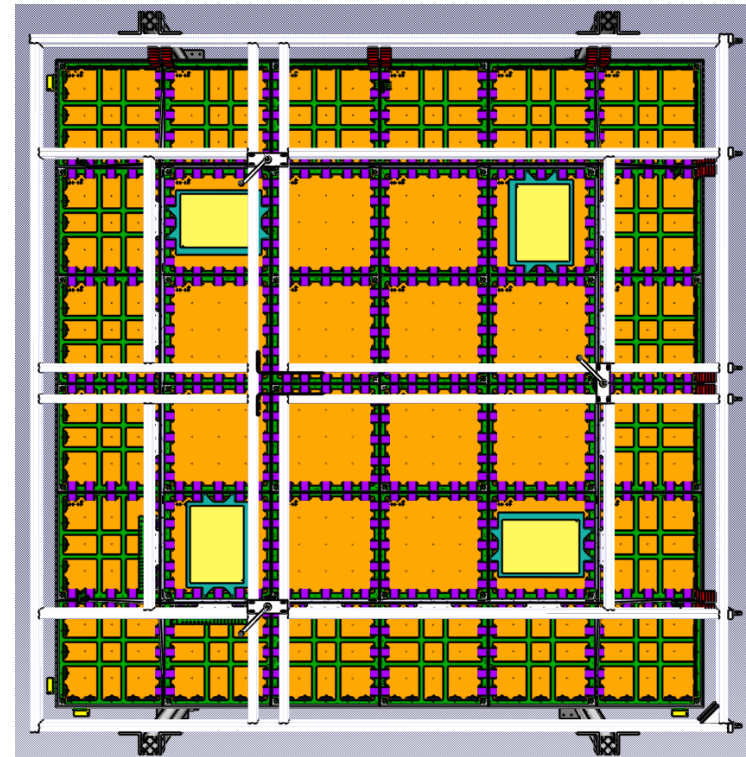
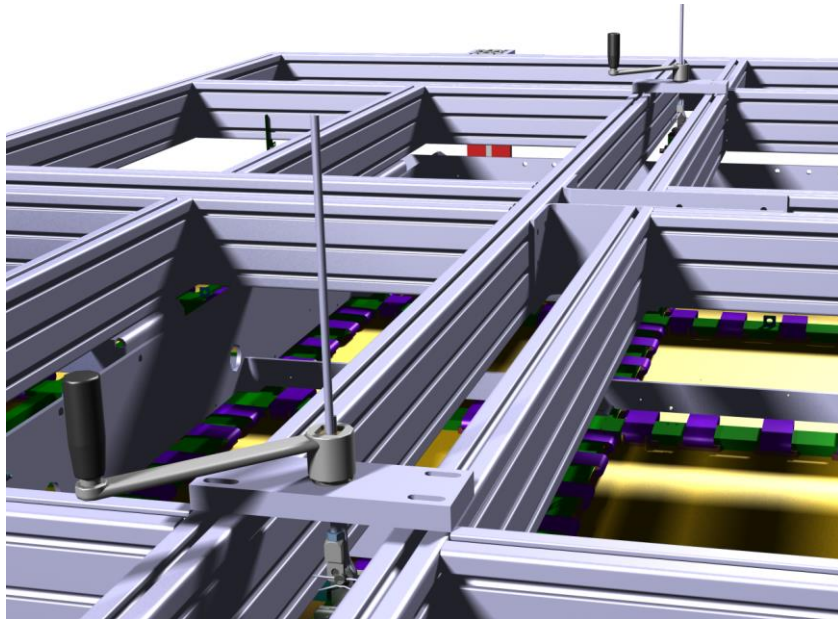
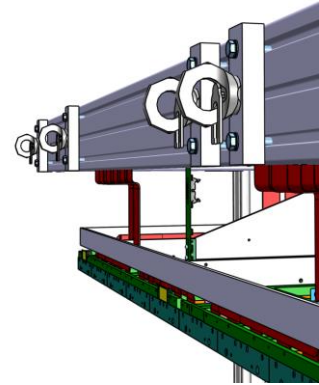

Box for transport

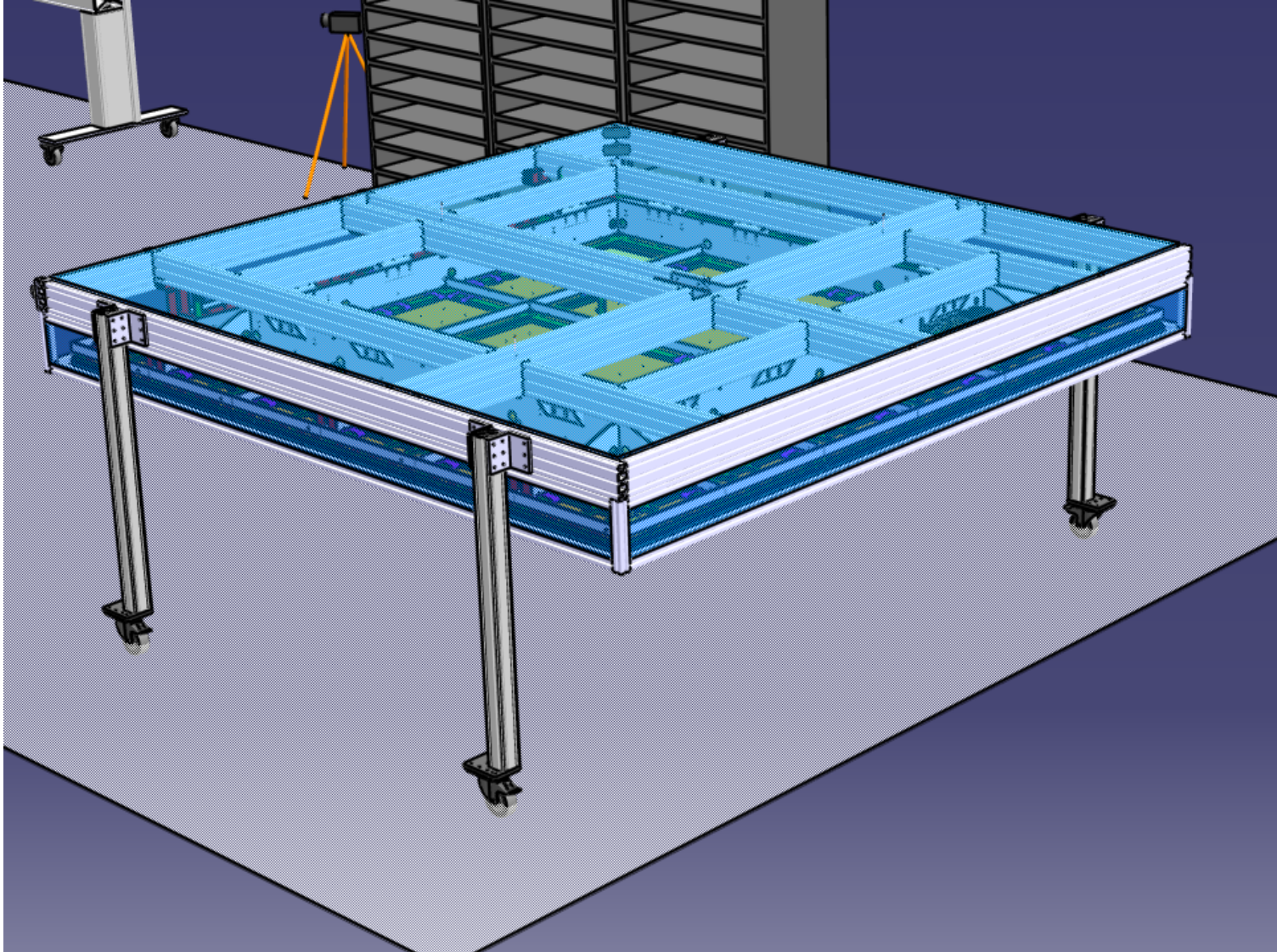

Assembly in Clean Room 185

- See the animation of the assembly

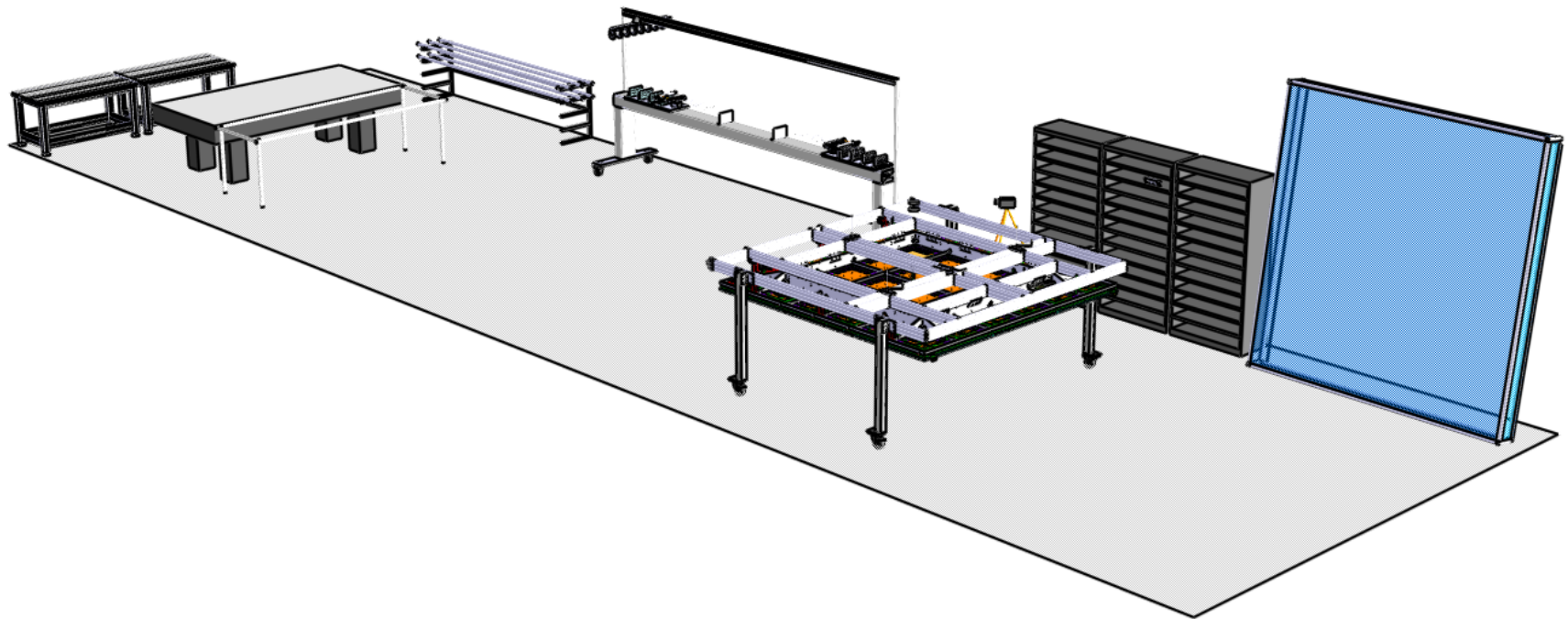

Assembly in Clean Room 185

- Tooling list has been set for order
- CRP parts orders are in imminent
- Detailed installation planning planning is currently being discussed and will be presented soon

Type	Outil / Pièce	Quantité	Achetez	Fournisseur	Tarif unitaire	Tarif Total	Remarque
Ameublement salle blanche	Structure elcom en complément de la table optique existante		Oui	Eloom		1500	On économise le prix d'une table optique.
	Armoire Visserie et divers outillages	3	??	Billet Fournier	350	1050	
	Bacs visserie		??	Billet Fournier		400	
	Plan de travail	2	??	Billet Fournier	600	1200	
	Table de dessous de structure (pour vissage des	1		Billet Fournier	500	500	
Tressage grille	Banc de tressage de grille	1	Oui	Eloom + autres	20000	20000	
	Structure support pour stockage de sets de grille	1	Oui	Eloom + autres		1500	
	Hotte mobile	1	??	Farnell		1000	
	Aspirateur de salle blanche	1	??	Farnell		1000	
	Station de soudage	1	??	Farnell		150	
Outillage	Clés plates		??	Billet Fournier			
	Clés allen		??	Billet Fournier			
	Visseuse électrique	3	??	Farnell			
	Clés à cliquet		??	Billet Fournier			
	Tournevis		??	Billet Fournier			
	Clés dynamométriques		??	Billet Fournier			
Total outillage						2000	
Structure porteuse /	Profilés Elcom		Oui	Eloom			
	Roulettes		Oui	Eloom			
	Pièces à usiner		Oui	Usineur			
	Pièces standard diverses		Oui	Billet Fournier			
	Treuil à main (aussi pour SPFT)		Oui	A définir			
	Accessoires divers			A définir			
	Totale structure porteuse - echafaudage	4				5000	20000
Habillement Produits ménagers	Habillement complet salle blanche			A définir			Estimation du prix pour l'équipe pendant le temps d'installation?
	Produits de nettoyage			A définir			Estimation du prix pour l'équipe pendant le temps d'installation?
	Essui-tout			A définir			
					Total (I HT)	50300	(environ, en attendant une estimation plus précise)

Spares slides

(in case of pb with the animation...)

CRP Assembly

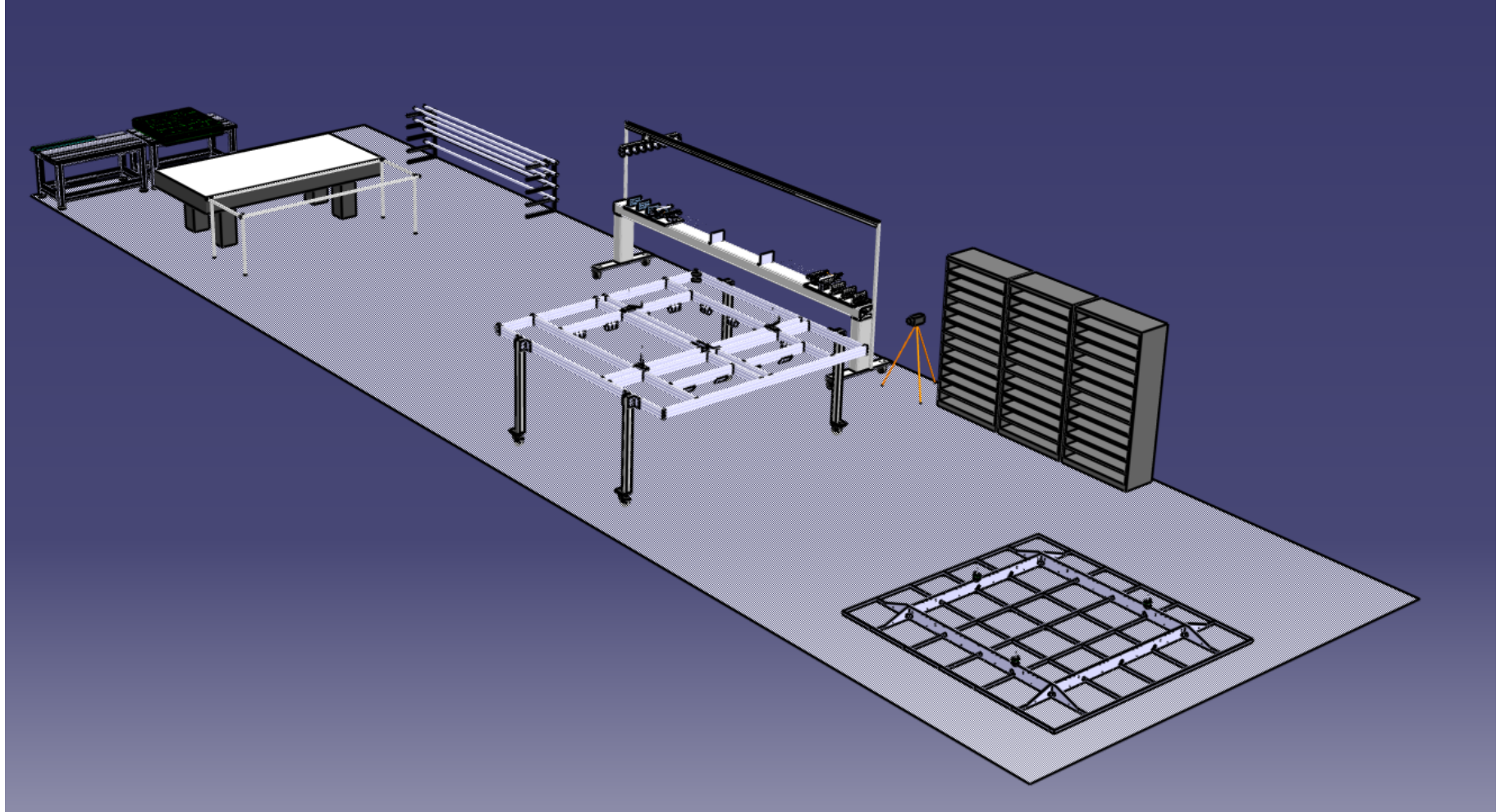

CRP Assembly

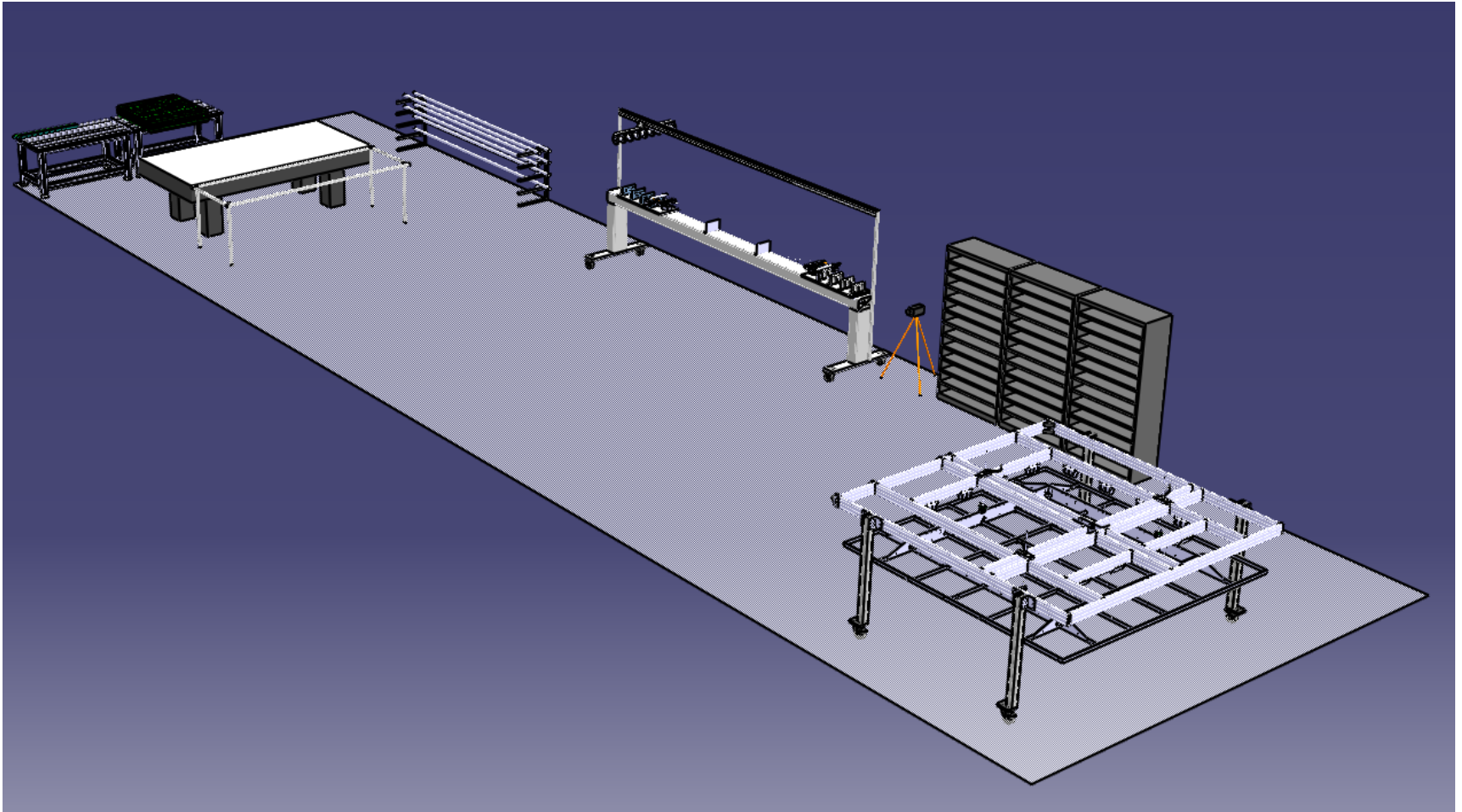

CRP Assembly

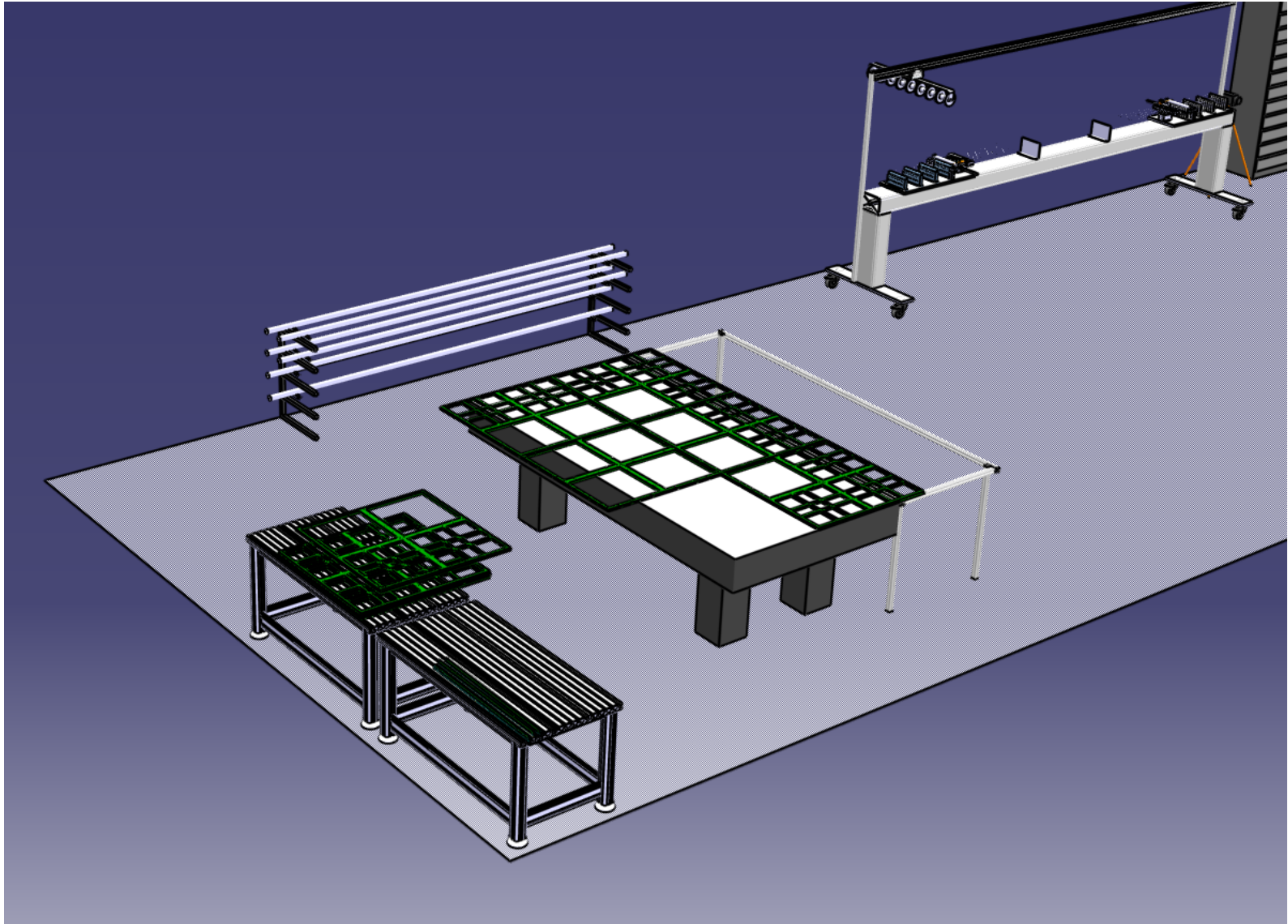

CRP Assembly

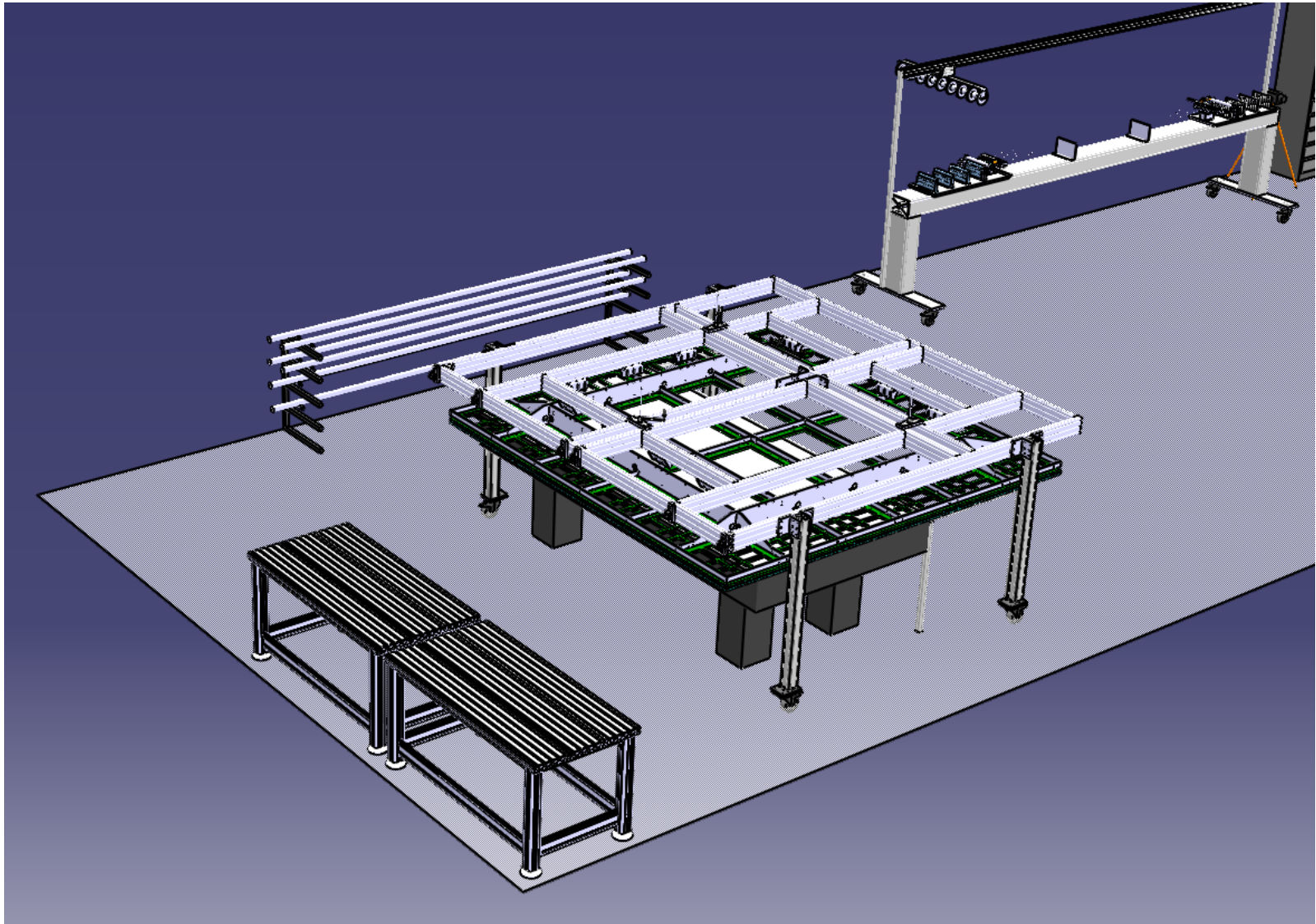

CRP Assembly

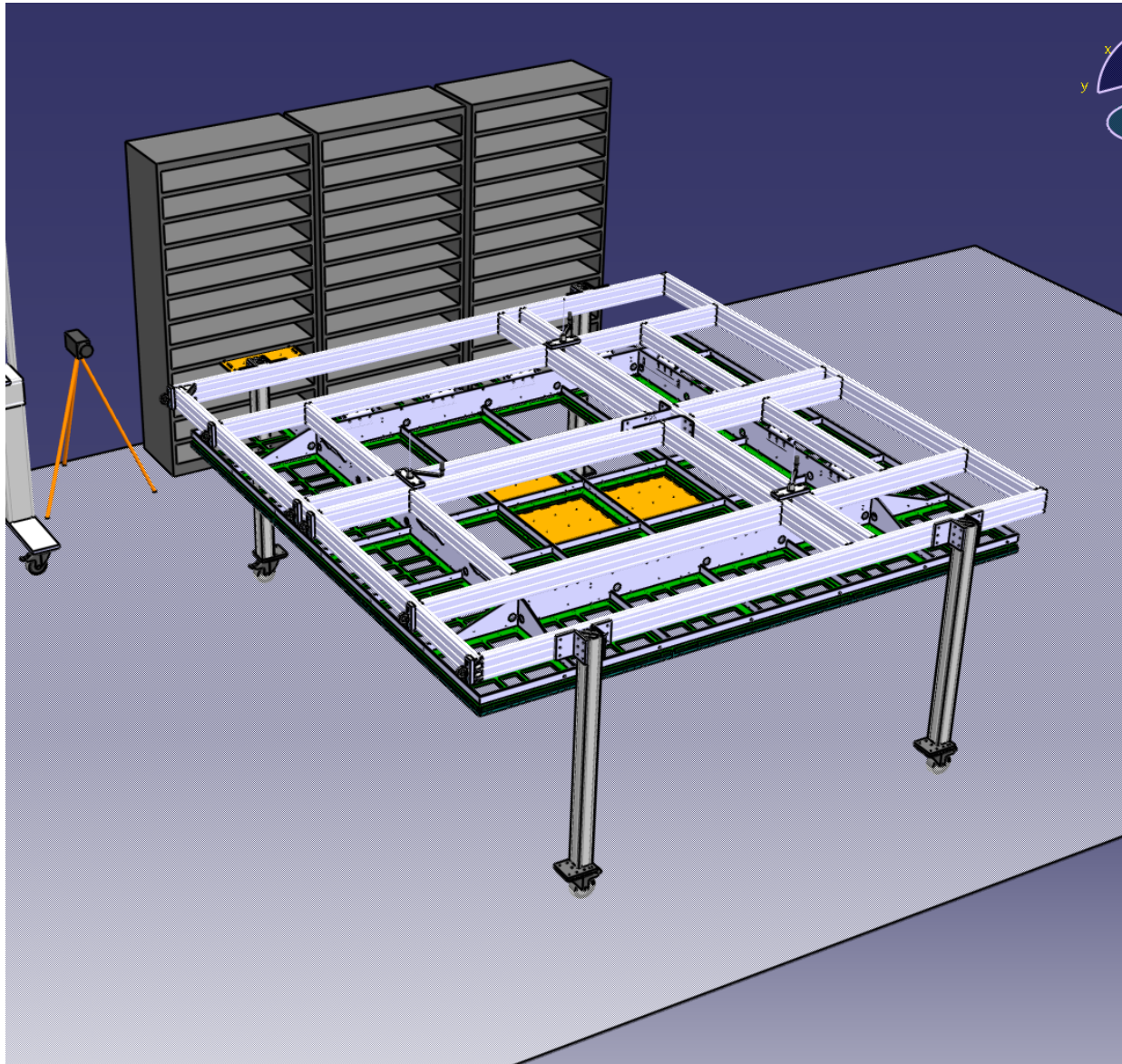

CRP Assembly

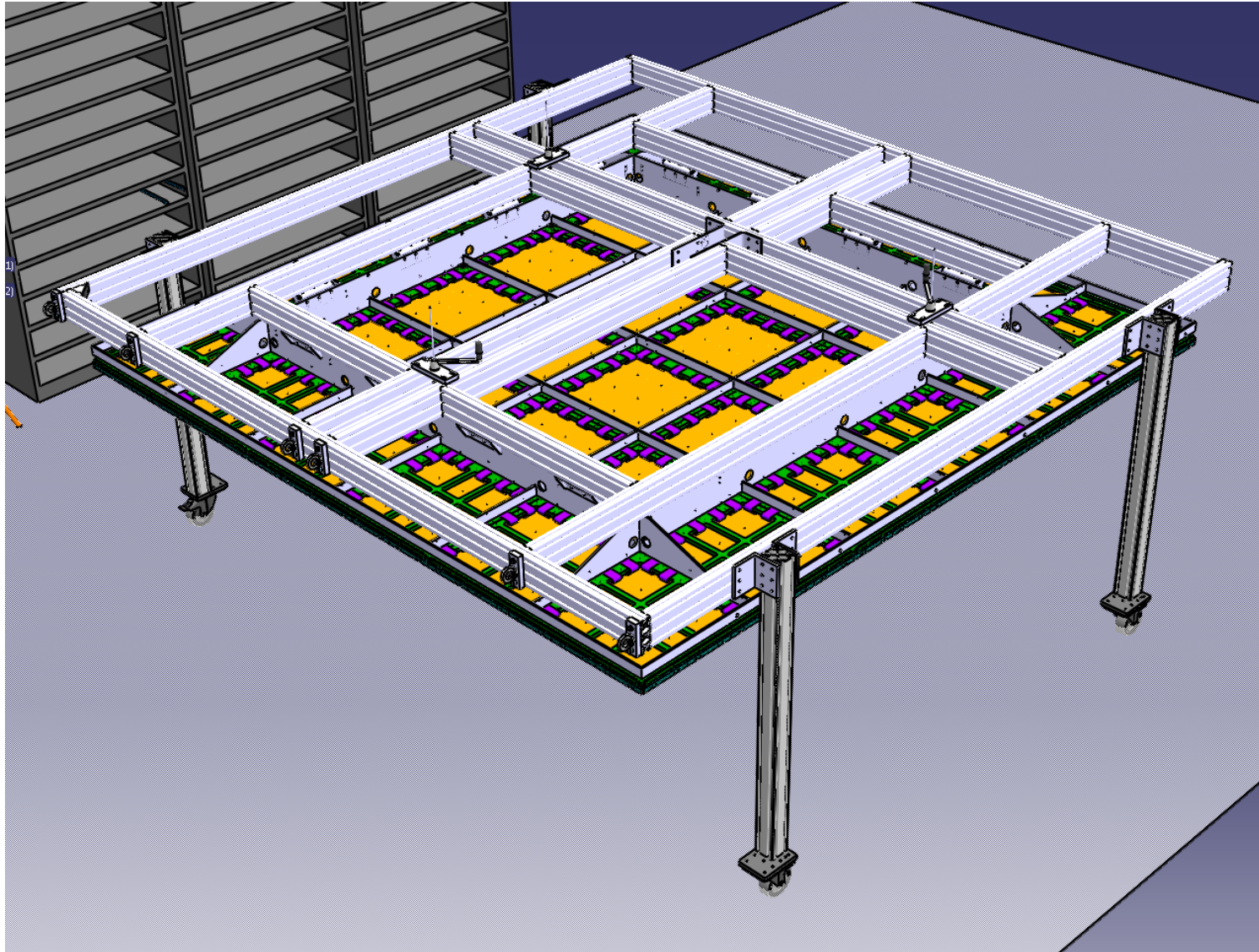

CRP Assembly

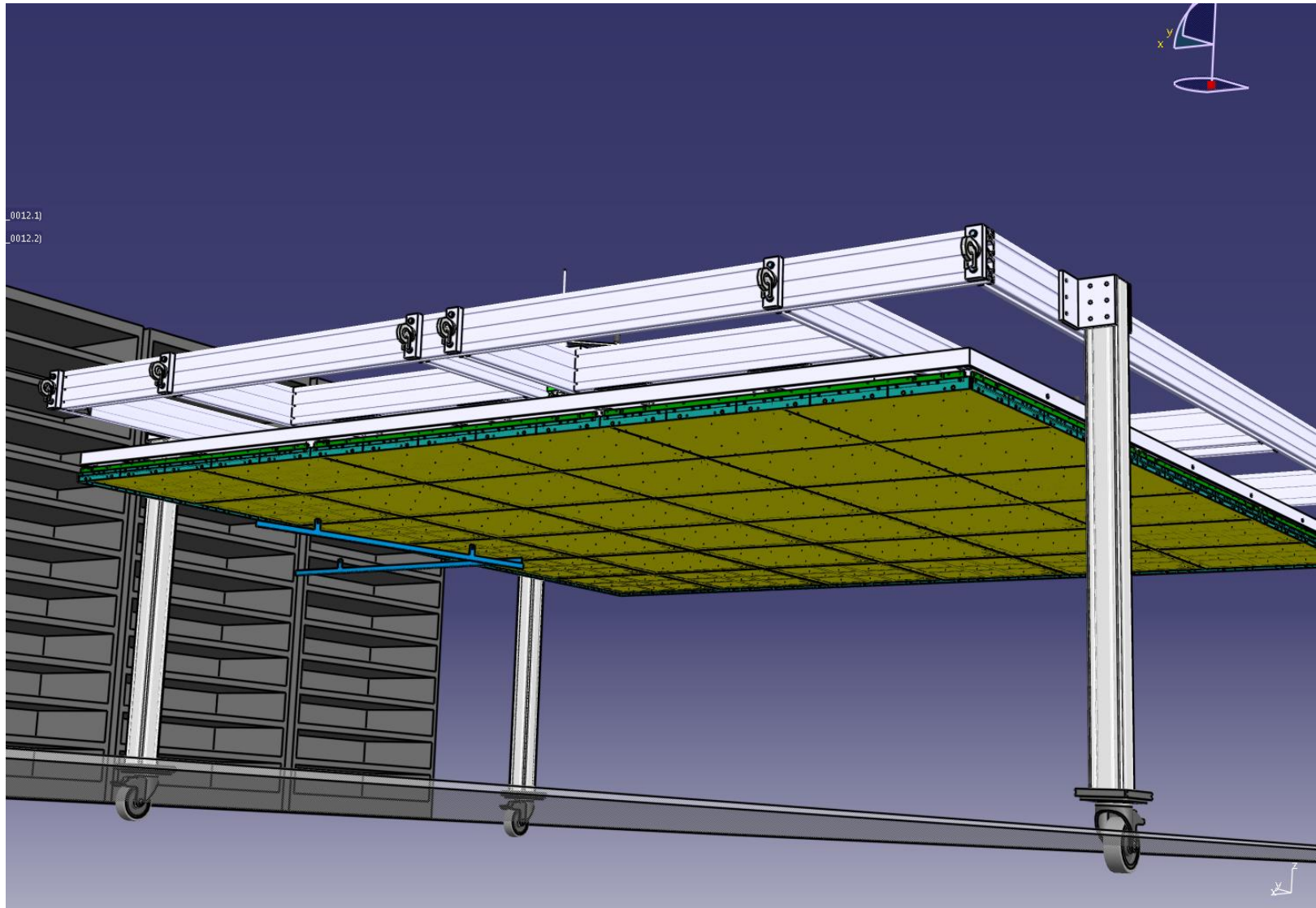

CRP Assembly

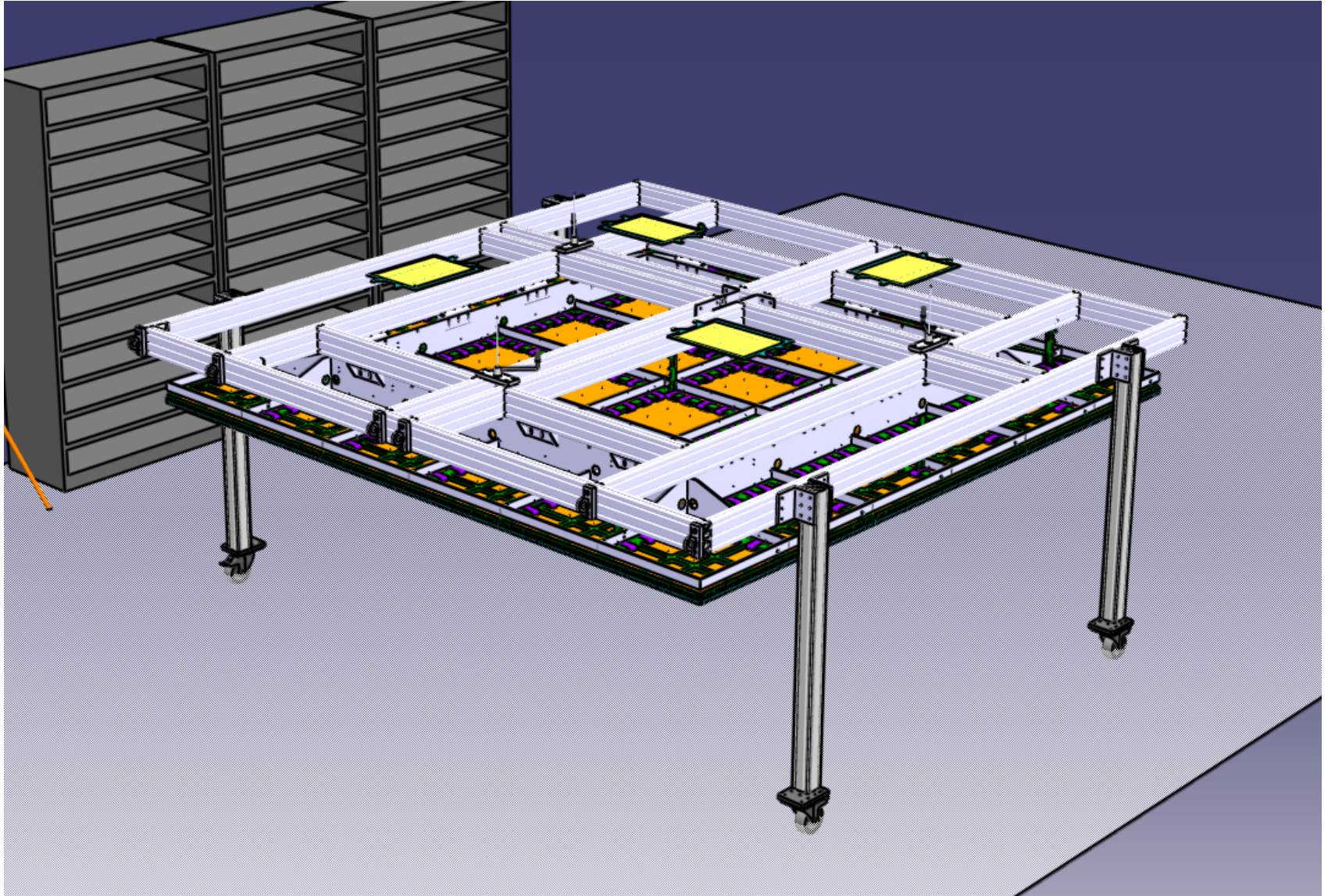

CRP Assembly

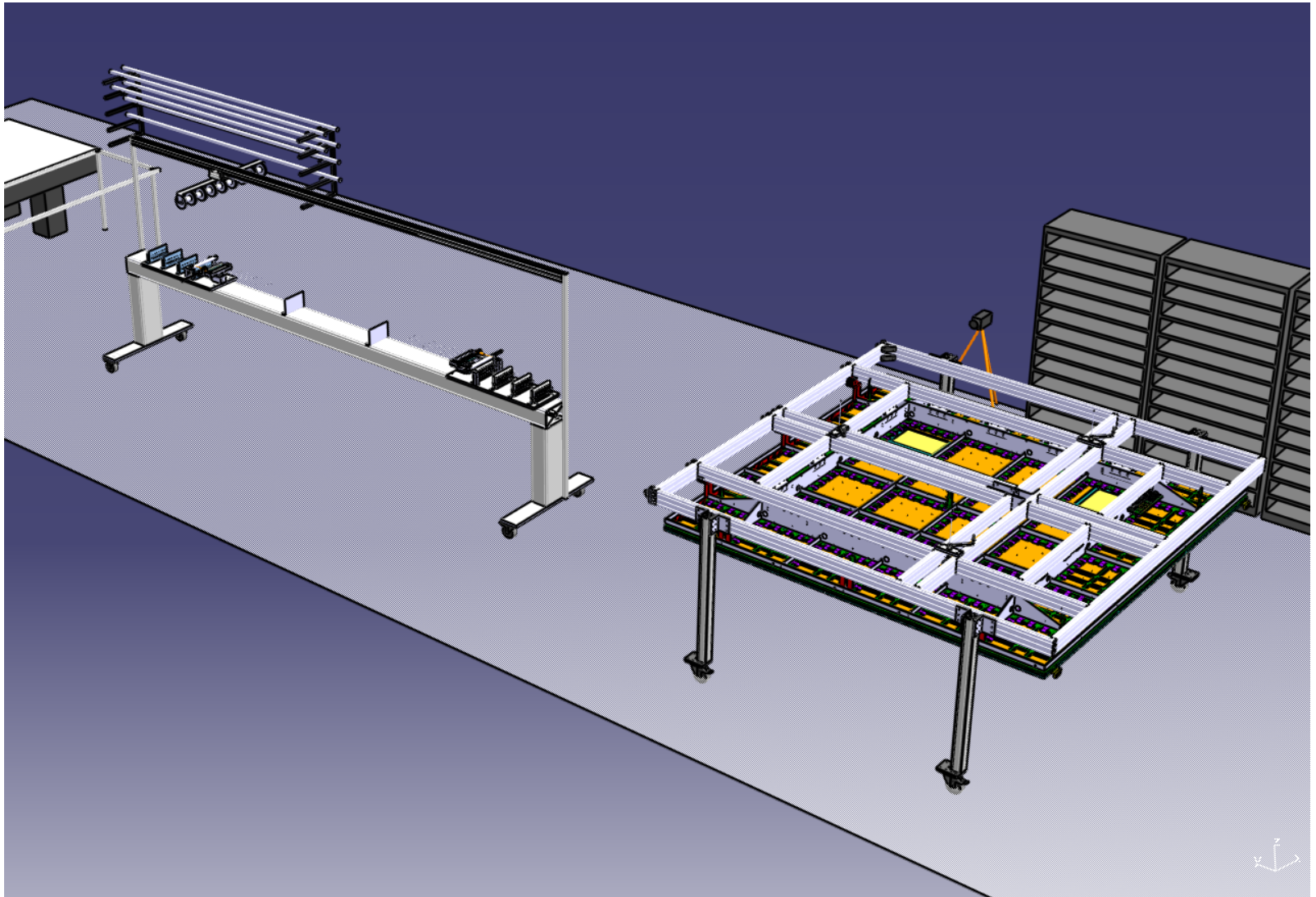

CRP Assembly

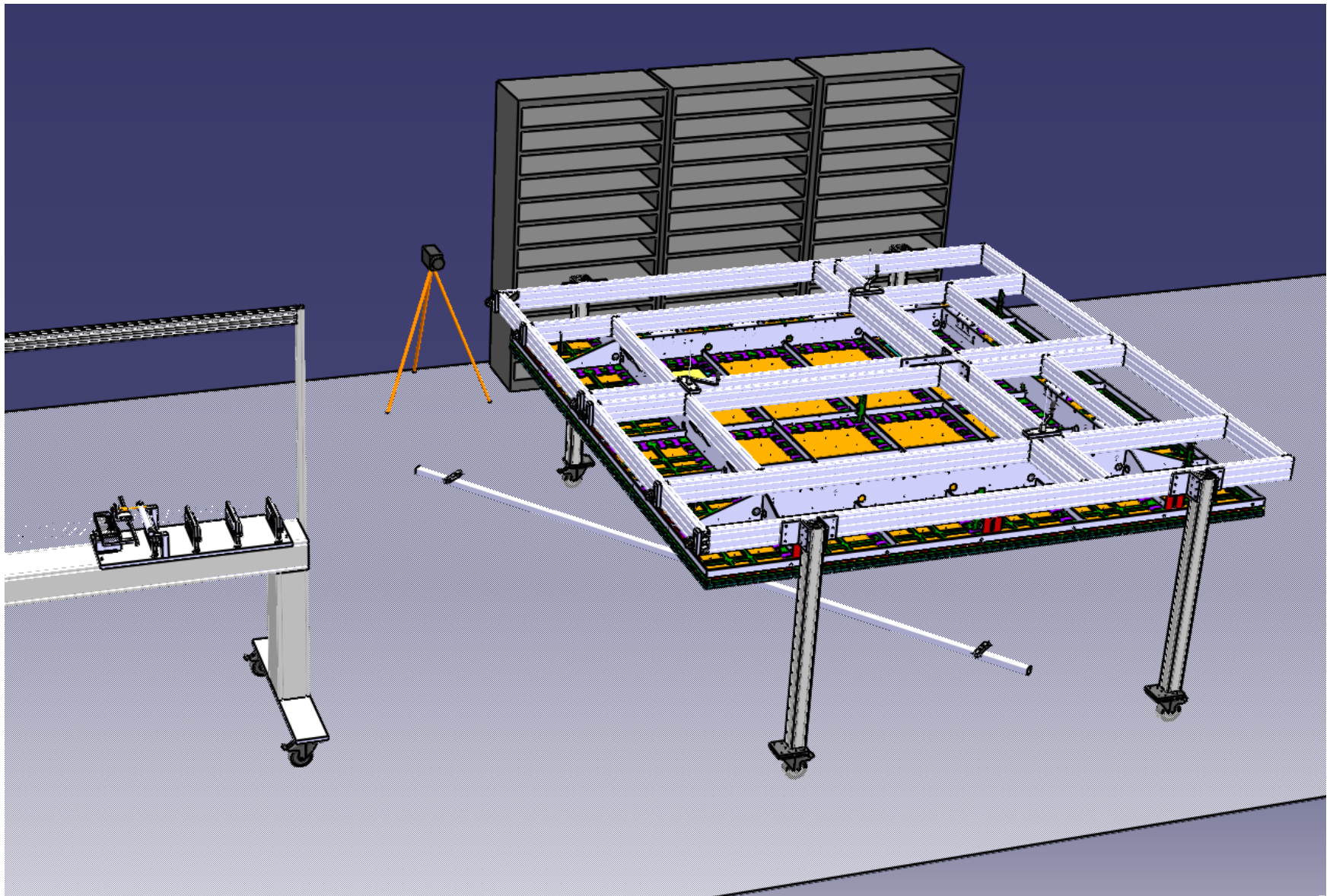

CRP Assembly

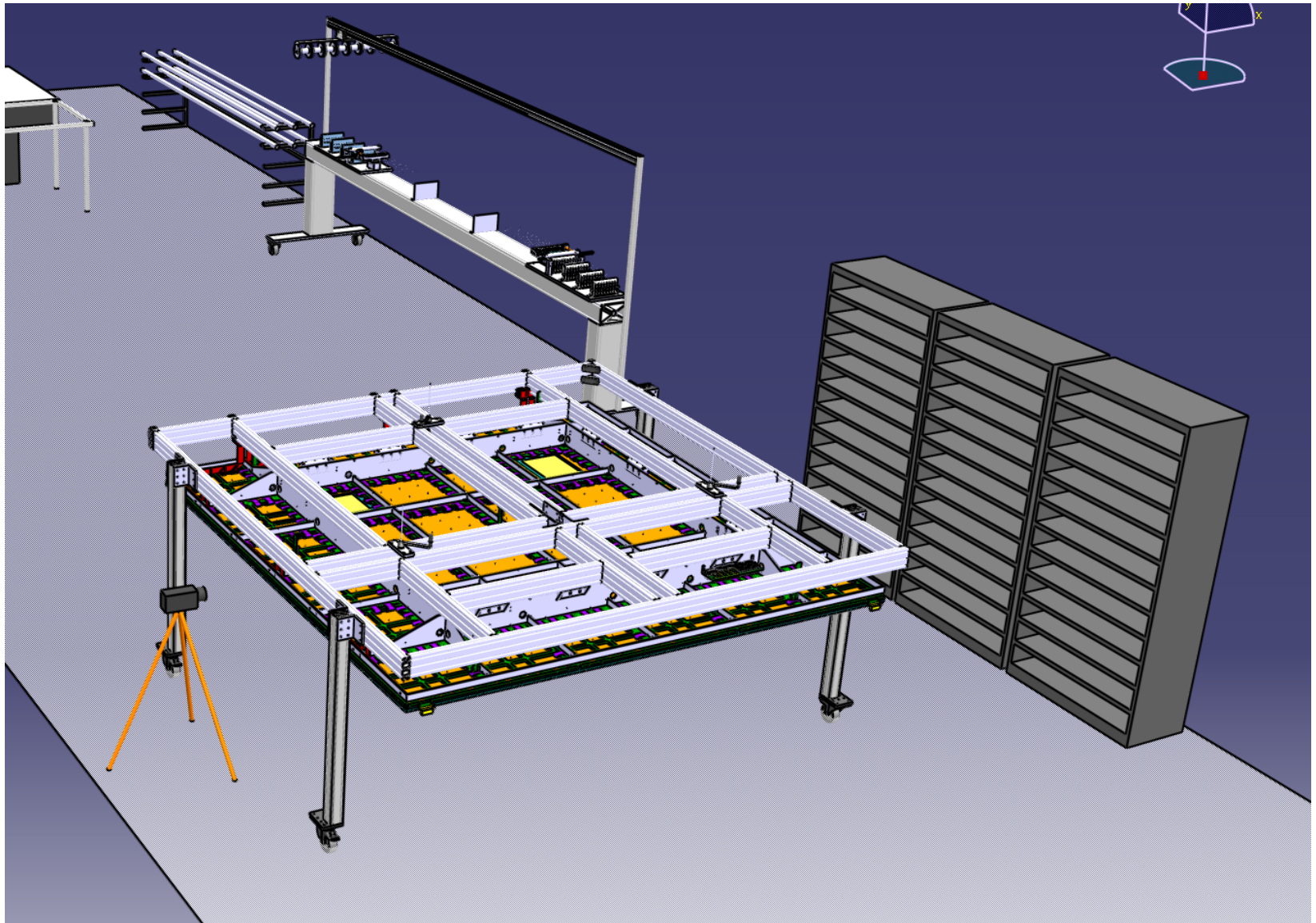

CRP Assembly

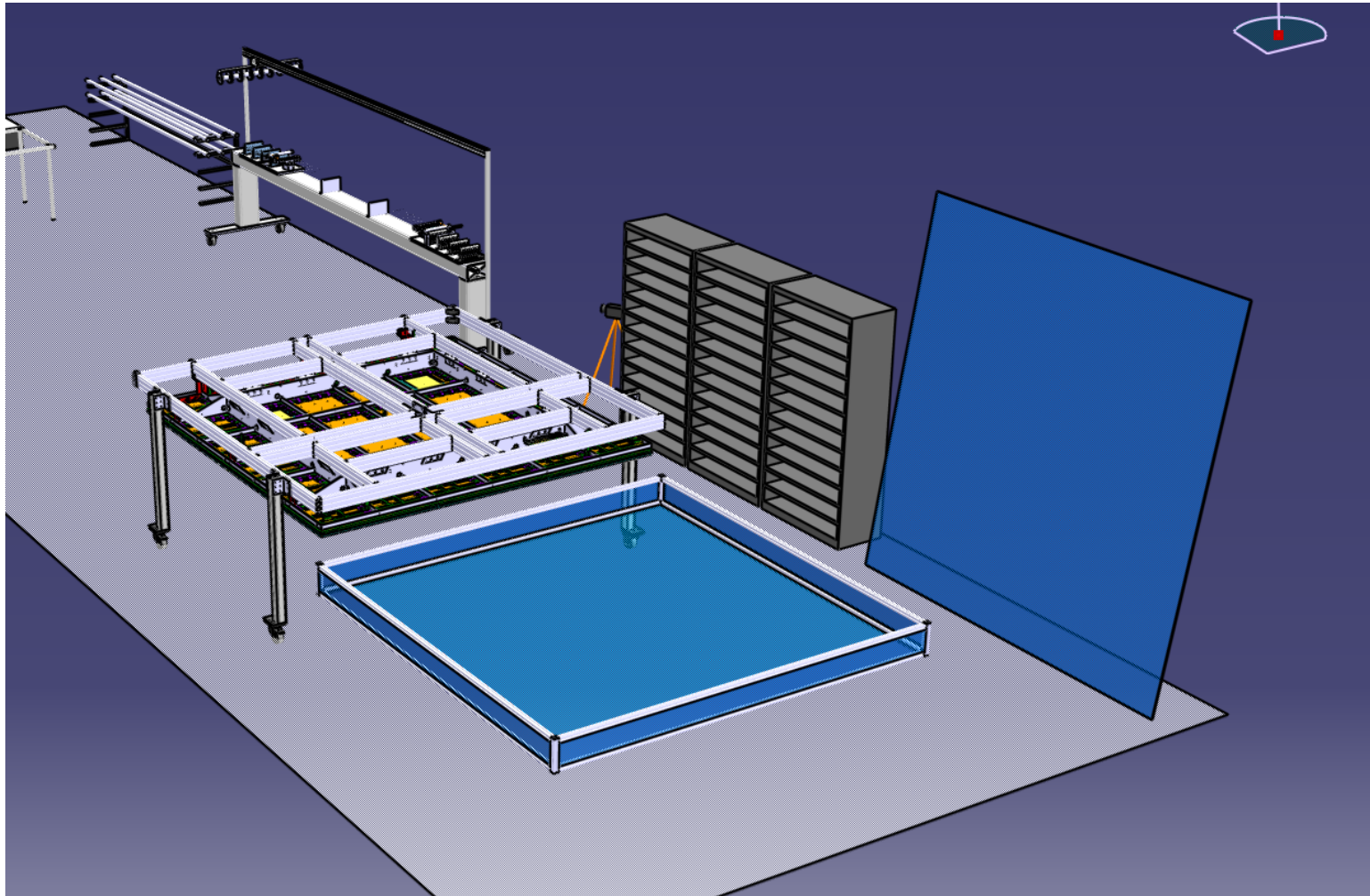

CRP Assembly

