

ProtoDUNE dual-phase overview

Dario Autiero (IPNL Lyon)
Technical Design Review
CERN, April 24, 2017

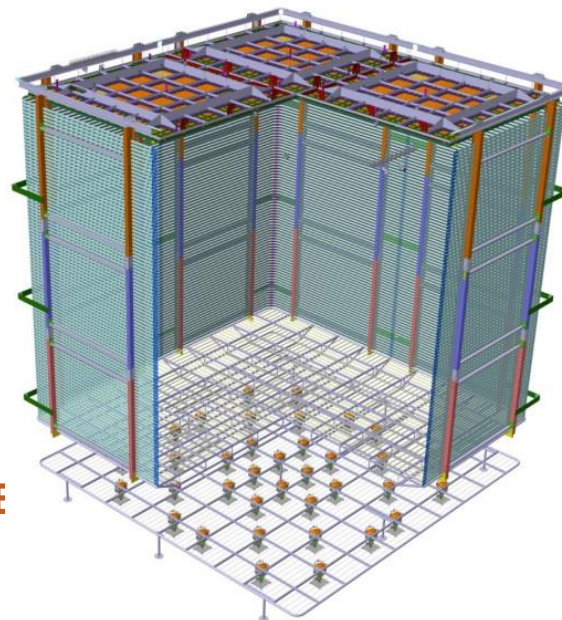

WA105
Dual-Phase ProtoDUNE

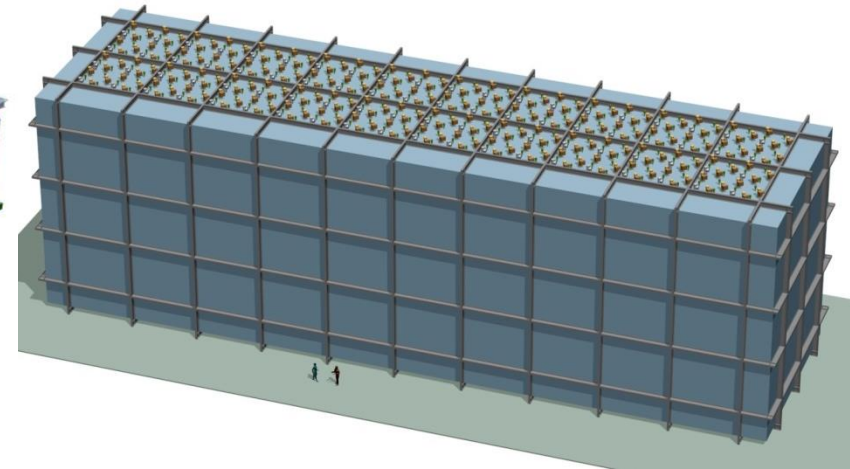

DUNE

Double-phase readout:

Long drift, high S/N: extraction of electrons from the liquid and multiplication with avalanches in pure argon with micro-pattern detectors like LEM (Large Electron Multipliers)

Tunable gain (~20 minimum), two symmetric collection views, coupling to cold electronics

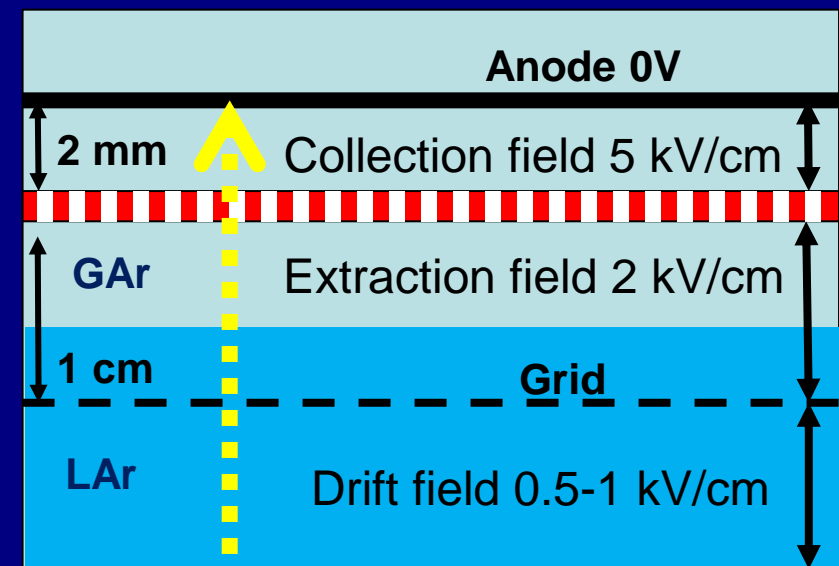

LEM (1mm)
25-35 kV/cm

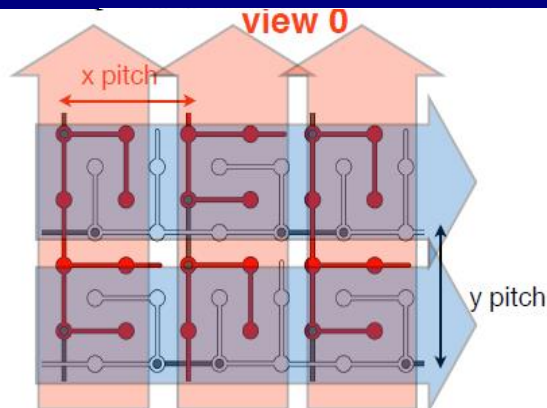
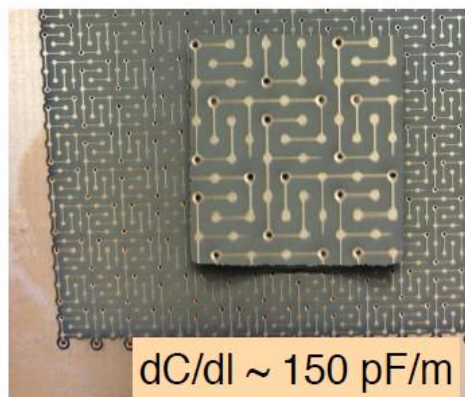
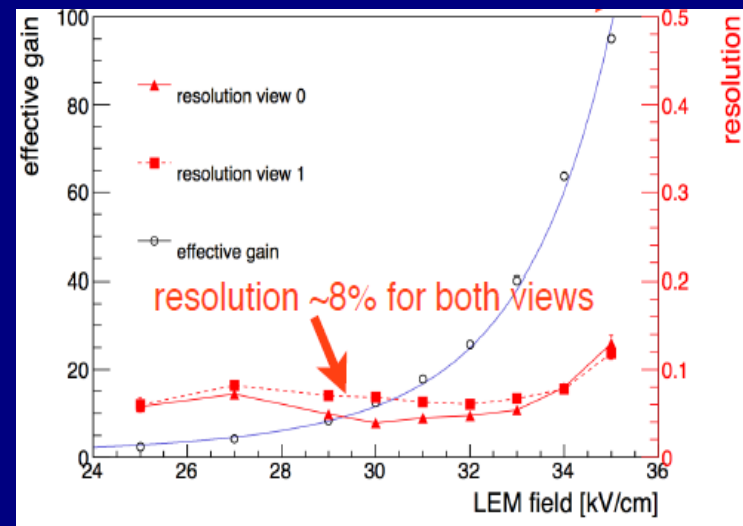

view 1



Dual-phase 10 kton FD module

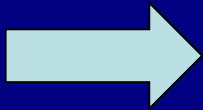

- 80 CRP units
- 60 field shaping rings
- 240 signal FT chimneys
- 240 suspension chimneys
- 180 PMTs
- 153600 readout channels

Dual-Phase DUNE FD: 20 times replication of Dual-Phase ProtoDUNE (drift 6m → 12m) DUNE Conceptual Design Report, July 2015
Active LAr mass: 12.096 kton, fid mass: 10.643 kton, N. of channels: 153600

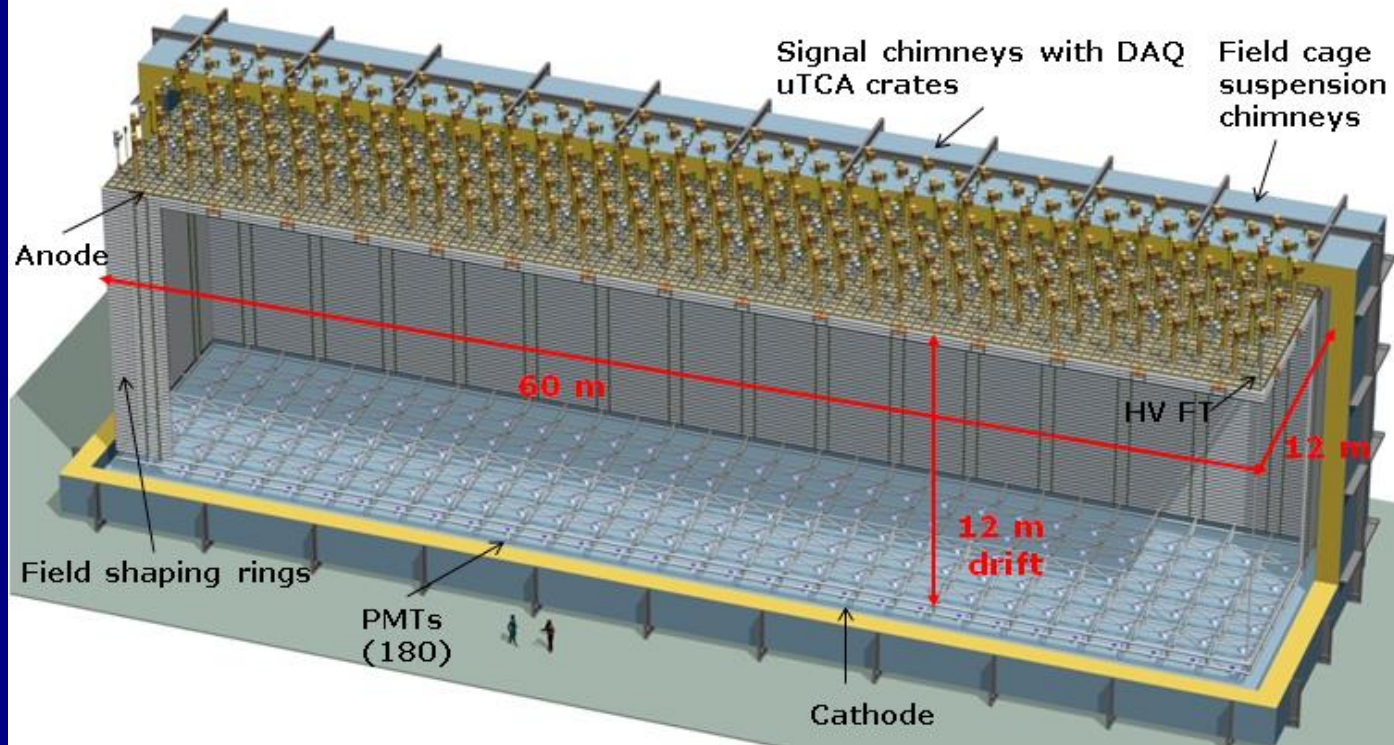

Advantages of double-phase design:

- Anode with 2 collection (X, Y) views (no induction views), no ambiguities
- Strips pitch 3.125 mm, 3 m length
- Tunable gain in gas phase (20-100), high S/N ratio for m.i.p. > 100, <100 KeV threshold, min. purity requirement 3ms → operative margins vs purity, noise
- Long drift projective geometry: reduced number of readout channels
- No materials in the active volume
- Accessible and replaceable cryogenic FE electronics, high bandwidth low cost external uTCA digital electronics

Dual phase liquid argon TPC
6x6x6 m³ active volume

→ Event size: drift window of
7680 channels x 10000 samples ⇒ 146.8 MB

X and Y charge collection strips
3.125 mm pitch, 3 m long → 7680 readout channels

Segmented anode
in gas phase with
dual phase
amplification

Drift coordinate
6 m = 4 ms
sampling 2.5 MHz
(400 ns), 12 bits

→ 10000 samples
per drift window

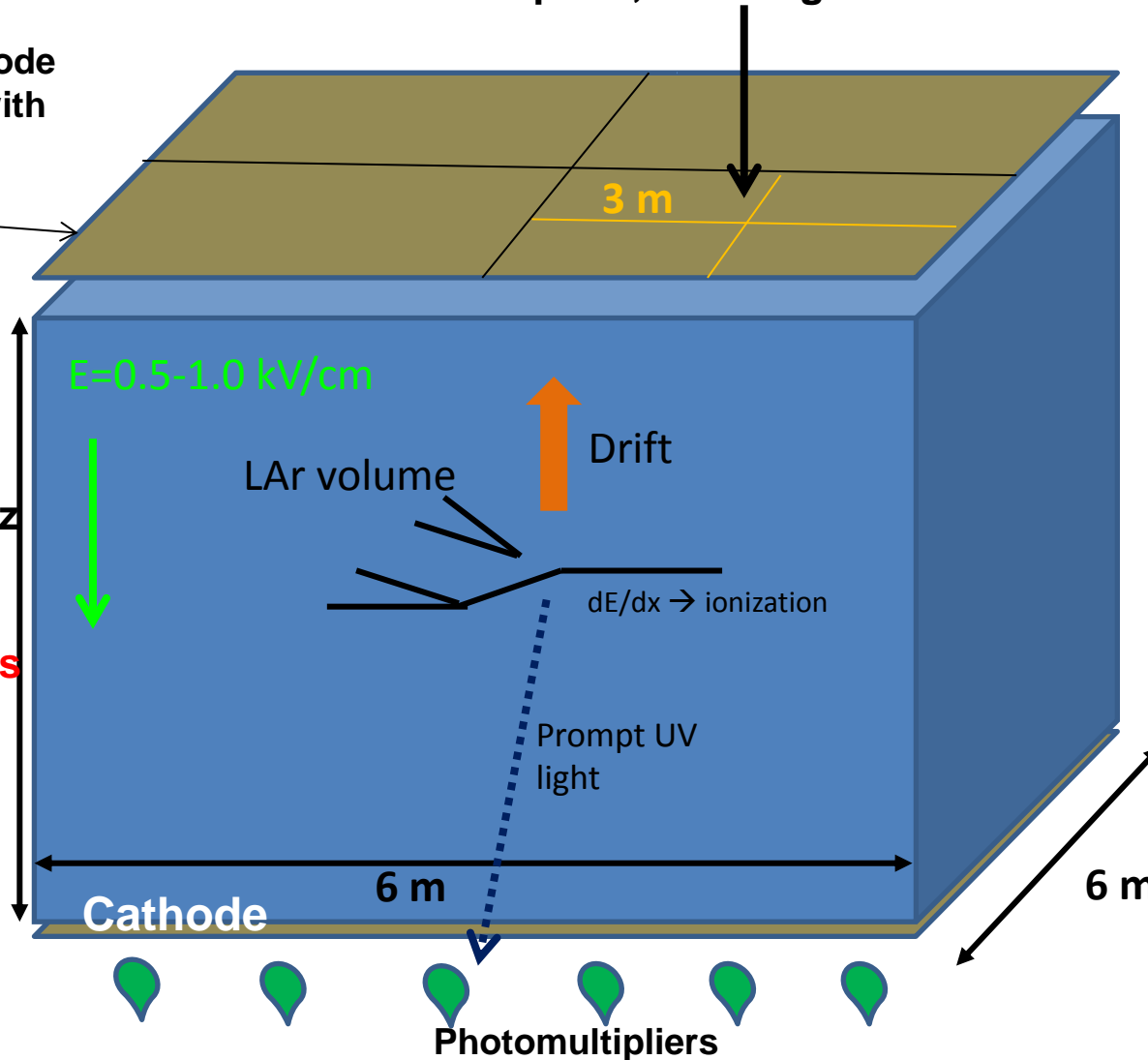

History of Dual-Phase ProtoDUNE / WA105

LBNO-DEMO (WA105)

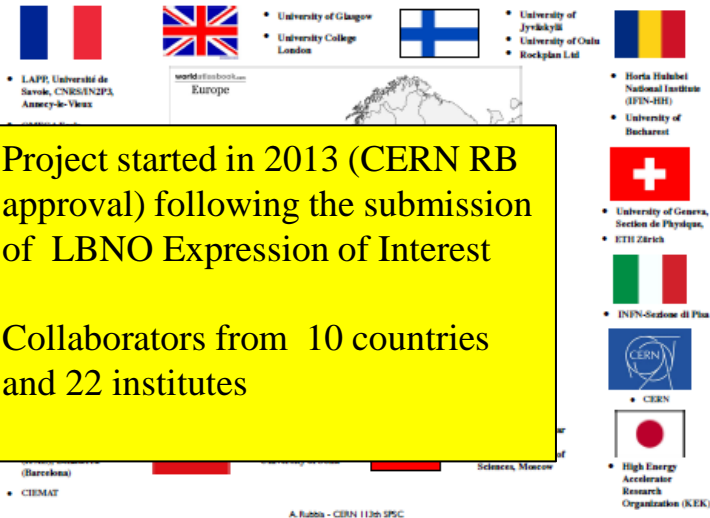

Collaborators from 10 countries and 22 institutes

- LAPP, Université de Savoie, CNRS/IN2P3, Annecy-le-Vieux
- University of Glasgow
- University College London
- University of Jyväskylä
- University of Oulu
- Rockspan Ltd
- Horia Hulubei National Institute (IFIN-HH)
- University of Bucharest
- University of Geneva, Section de Physique, ETH Zürich
- INFN-Sezione di Pisa
- CERN
- High Energy Accelerator Research Organization (KEK)

Project started in 2013 (CERN RB approval) following the submission of LBNO Expression of Interest

Collaborators from 10 countries and 22 institutes

EUROPEAN ORGANIZATION FOR NUCLEAR RESEARCH

CERN-
March

2015 Annual SPSC progress report 31st March 2015
SPSC-SR-158

Progress report on LBNO-DEMO/WA105 (2015)

The WA105 Collaboration

G. Balik, L. Brunetti, I. De Bonis, P. Del Amo Sanchez, G. Deleglise, C. Drancourt, D. Duchesneau, N. Geffroy, Y. Karyotakis, and H. Pessard
LAPP, Université de Savoie, CNRS/IN2P3, Annecy-le-Vieux, France

B. Bourguille, S. Bordon, T. Lux, and F. Sanchez
Institut de Fisica d'Altes Energies (IFAE), Bellaterra (Barcelona), Spain

A. Jipa, I. Lazanu, M. Calin, C.A. Ene, T. Esanu, O. Ristea, C. Ristea, S.A. Nae, and L. Nita
Faculty of Physics, University of Bucharest, Bucharest, Romania

P. Bourgeois, F. Duval, I. Efthymiopoulos, U. Kose, G. Maire, D. Mladenov, M. Nesi, and F. Noto
CERN, Geneva, Switzerland

A. Blondel, Y. Karadzhov, and E. Noah
University of Geneva, Section de Physique, DPNC, Geneva, Switzerland

R. Bayes and F.J.P. Soler
University of Glasgow, Glasgow, United Kingdom

G.A. Nuijten

CERN-SPSC-2015-017 / SPSC-SR-158
31/03/2015

DUNE CDR, July 2015:
WA105 and Dual-phase
10 kton design

WA105 project MOU fully
signed, December 2015

EUROPEAN ORGANIZATION FOR NUCLEAR RESEARCH

March 31st, 2014
CERN-SPSC-2014-013
SPSC-TDR-004

Technical Design Report
for large-scale neutrino detectors prototyping
and phased performance assessment
in view of a long-baseline oscillation experiment

Integration in DUNE project as DP-ProtoDUNE
December 2015; EOI call for ProtoDUNEs, January 2016

EUROPEAN ORGANIZATION FOR NUCLEAR RESEARCH

2016 Annual SPSC progress
report, April 7th 2016
CERN-SPSC-2016-017
SPSC-SR-184

TDR
submitted on 31st March 2014
CERN-SPSC-2014-013
SPSC-TDR-004(2014)

LBNC review June 2016,
LBNC review October 2016

Yoshinori Kubota, CERN/WA105 ProtoDUNE Collaboration

B. Bourguille, S. Bordon, T. Lux, and F. Sanchez
Institut de Fisica d'Altes Energies (IFAE), Bellaterra (Barcelona), Spain

M. Calin, T. Esanu, A. Jipa, I. Lazanu, L. Nita, O. Ristea, and C. Ristea
Faculty of Physics, University of Bucharest, Bucharest, Romania

N. Bourgeois, F. Duval, I. Efthymiopoulos, U. Kose, G. Maire, D. Mladenov, M. Nesi, and F. Noto
CERN, Geneva, Switzerland

K. Loo, J. Maalampi, W.H. Trzaska, and S. Vihonen
Department of Physics, University of Jyväskylä, Finland

2017 Annual SPSC progress
report, April 4th 2017
CERN-SPSC-2017-011
SPSC-SR-206

Yearly progress report on WA105/ProtoDUNE dual-phase (2017)

The ProtoDUNE Dual Phase Collaboration

Abstract

WA105/ProtoDUNE dual-phase aims at fully demonstrating the concept of a very large dual-phase LAr TPC and calibrating it with a charged particles test beam, in view of the application of this detector design for the construction of DUNE 10kt₀₂ far detector modules. In this document we report the general progress of the dual-phase experimental activities at CERN since the last SPSC yearly report.

CERN-SPSC-2017-011 / SPSC-SR-206
21/03/2017



One year of progress documented in the report submitted to the SPSC 2017 annual review: <https://cds.cern.ch/record/2256436>

3x1x1 catalyzing progress on 6x6x6 m³:

- Membrane vessel design and procurement
- Cryogenics
- Charge Readout Plane (CRP) detectors
- CRP structure and hanging system
- Feedthroughs
- HV and field cage
- Charge readout FE electronics + digital electronics
- Light readout system + electronics
- DAQ and online processing
- Slow Control

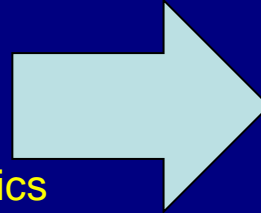

Advanced state of design, prototyping and production preparation

For many items huge benefit from immediate application of a smaller 3x1 prototype LAr-proto (minimal size of RO unit in 6x6x6)

- ✓ Fully engineered versions of many detector components with pre-production and direct implementation (installation details and ancillary services)
- ✓ First overview of the complete system integration: **set up full chains** for QA, construction, installation, commissioning
- ✓ **Anticipate legal and practical aspects** related to procurement, costs and schedule verification
- ✓ **Retirement of several risks for PD-DP** thanks to (1) identification of critical components (2) early detection of potential problems

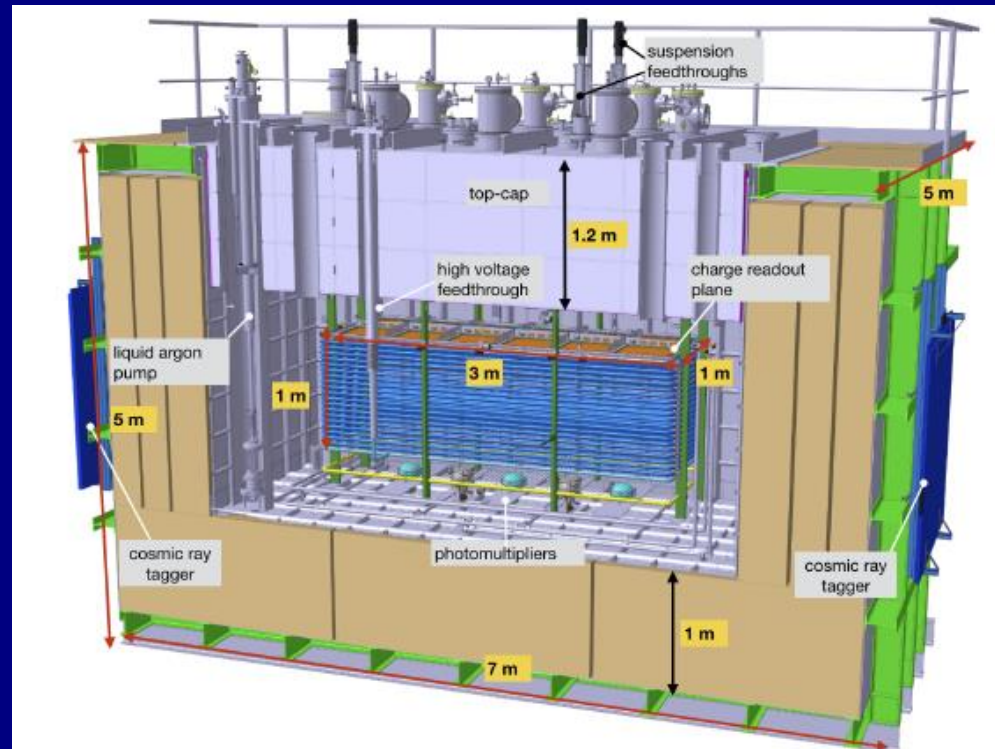

Pilot detector: $3 \times 1 \times 1 \text{ m}^3$

cryogenic pump tower

3 point suspension feedthroughs

instrumentation feedthroughs

signal feedthroughs

top-can

PMTs

Detector installation completed during the fall 2016

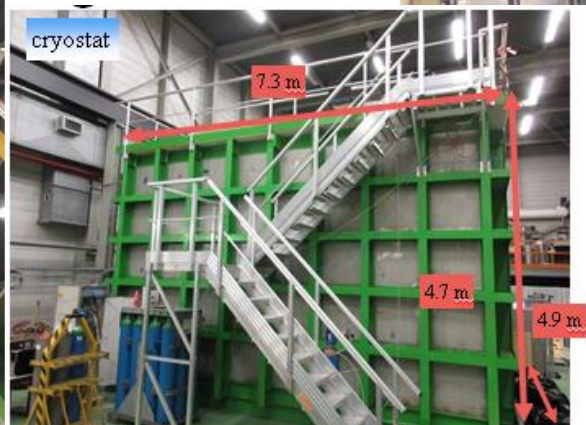
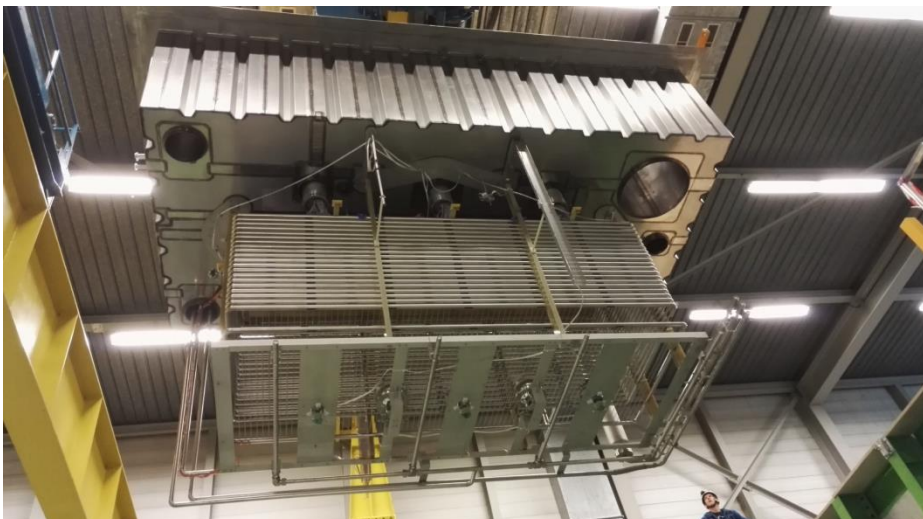
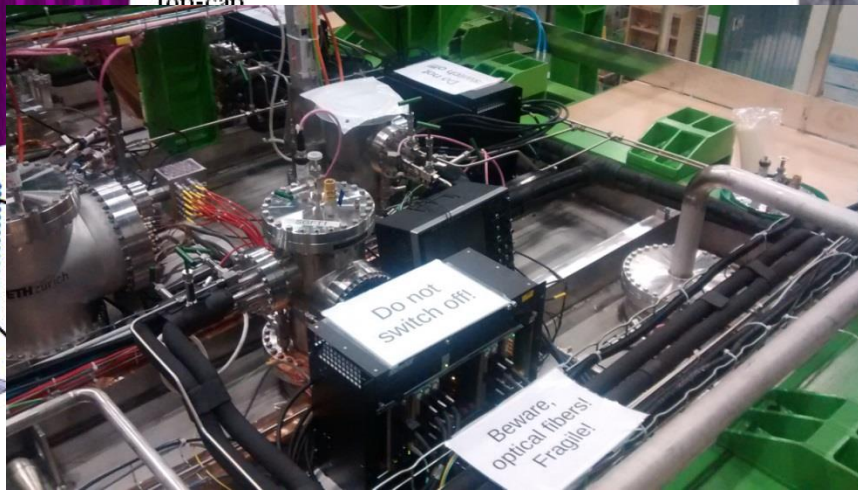
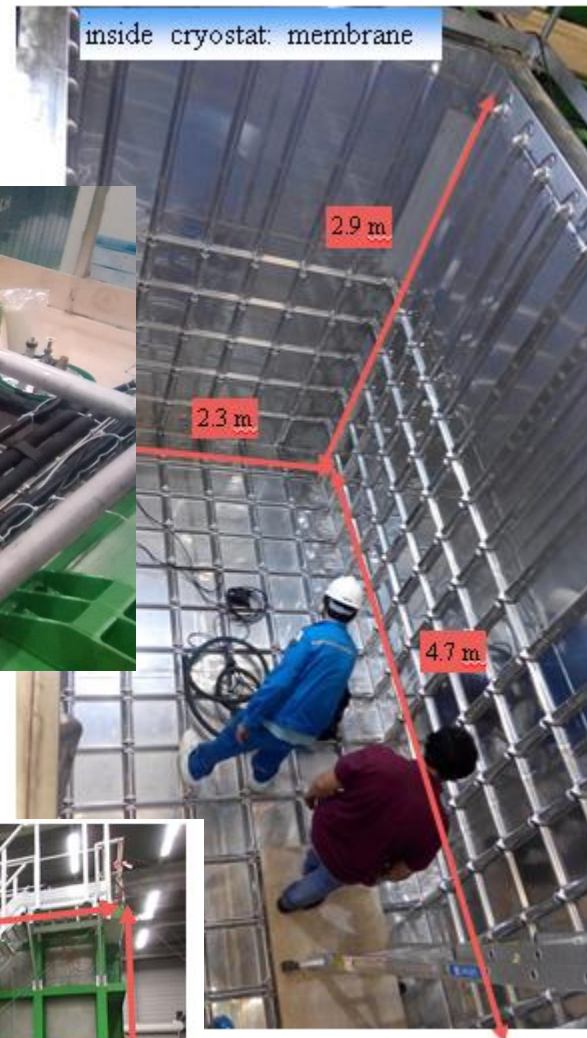

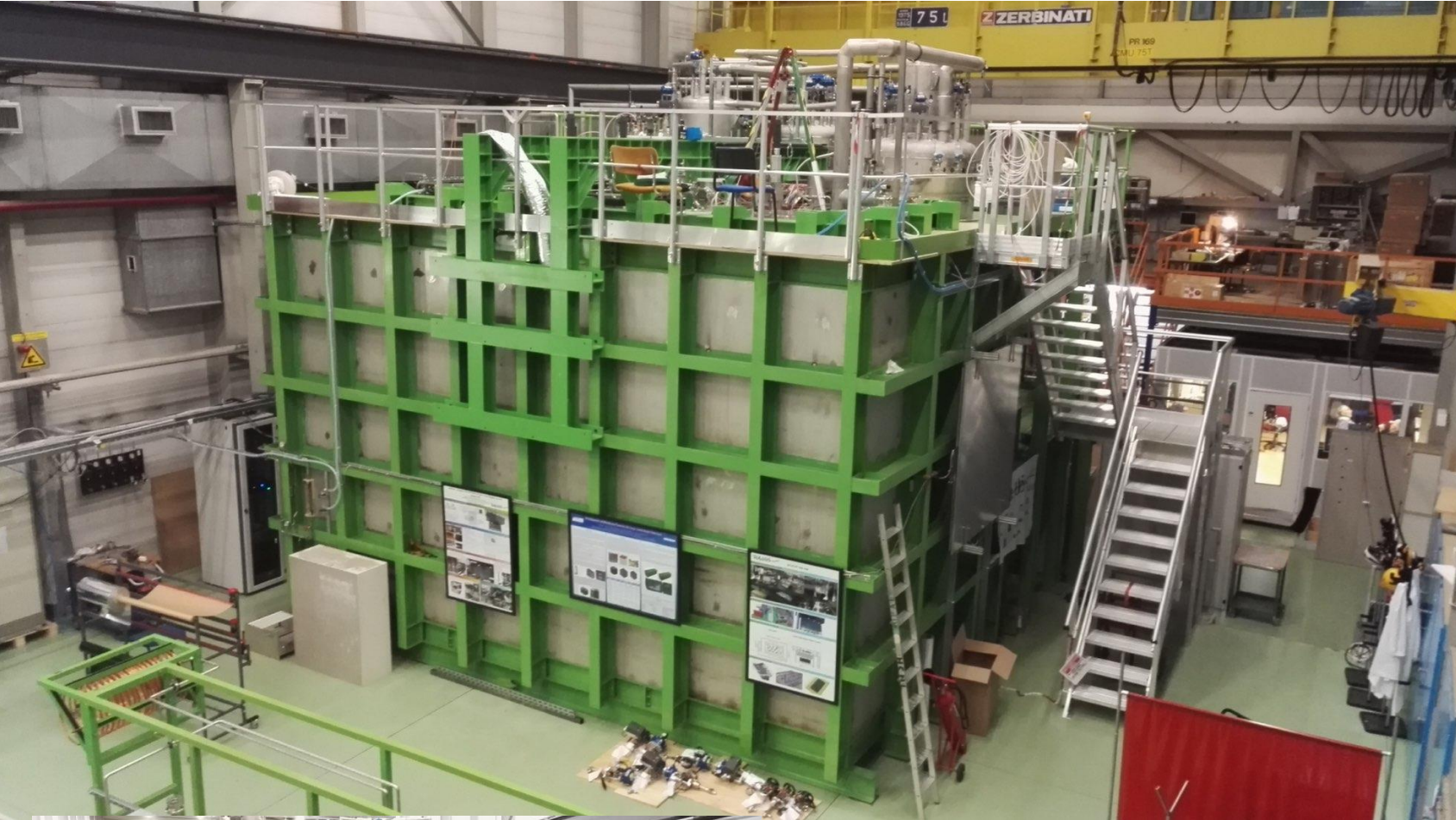

- Delay in the cryogenic system installation and of its commissioning
- The cryostat purge with pure argon was successfully performed by middle of February.
- Cool-down was almost completed on March 3rd in order to start filling with LAr when a cold spot of ice appeared in a corner of the cryostat
- Cryostat warmed up since March 3rd to investigate, Access on 14/3 → No leaks: defects in insulation
- Cryostat purging restarted on 5/4, cool-down stopped again on 15/4 due to appearance of new cold spots

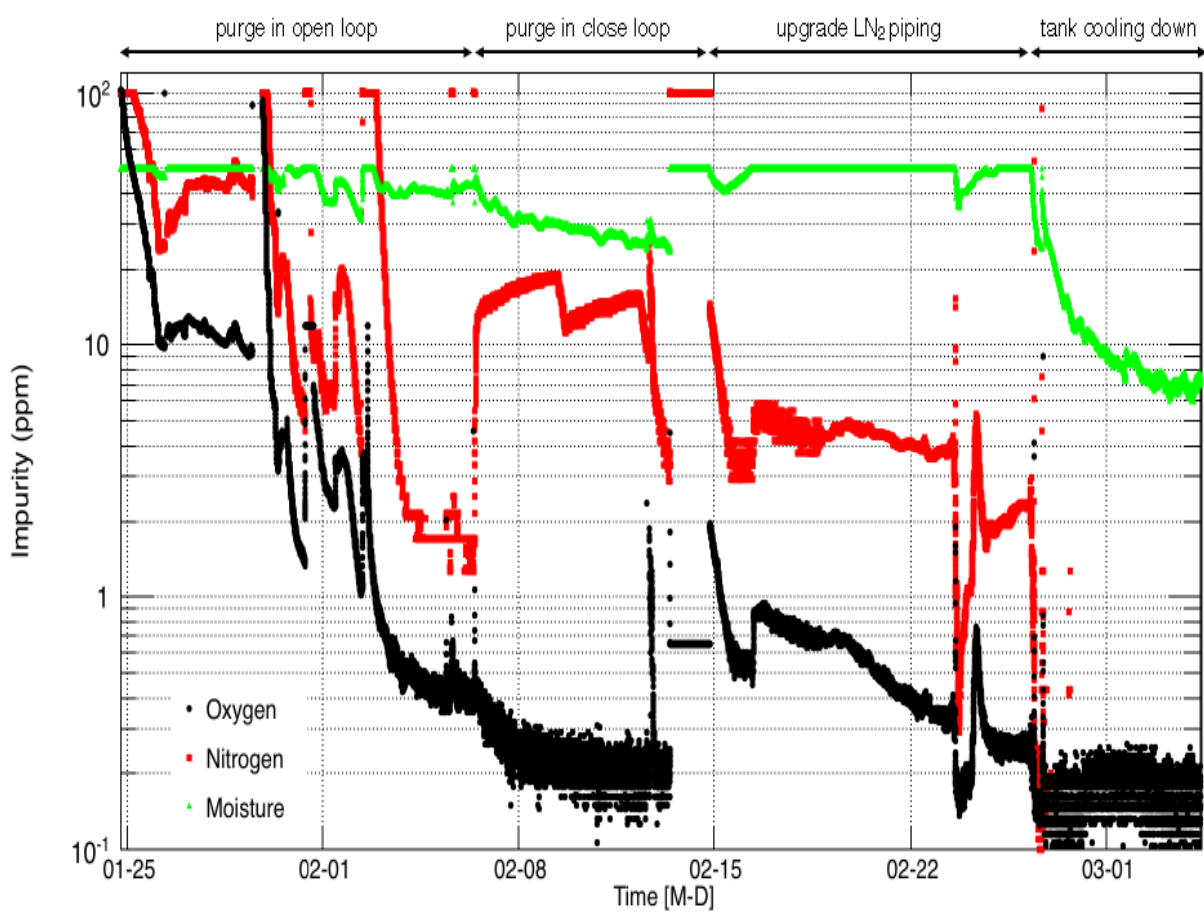

Gas purity evolution during purging (open and closed loop) and cool-down:

→ oxygen, nitrogen and moisture under control; no evidence for large outgassing or leaks

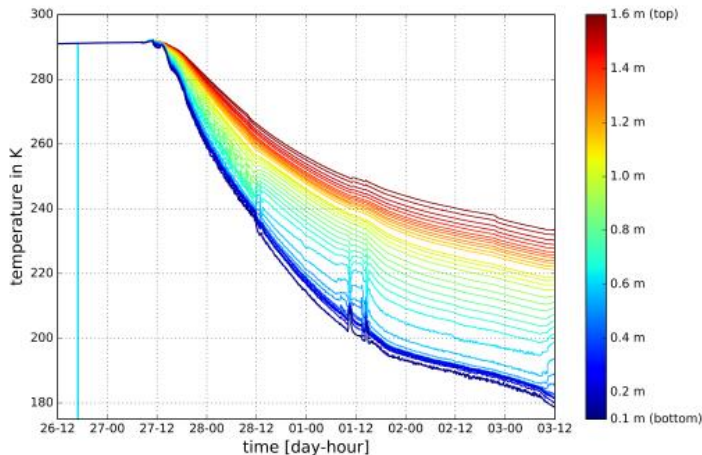

Measurements of temperature gradients in gas during cool down

Scintillation time in GAR (1000 mBar, 215 K)

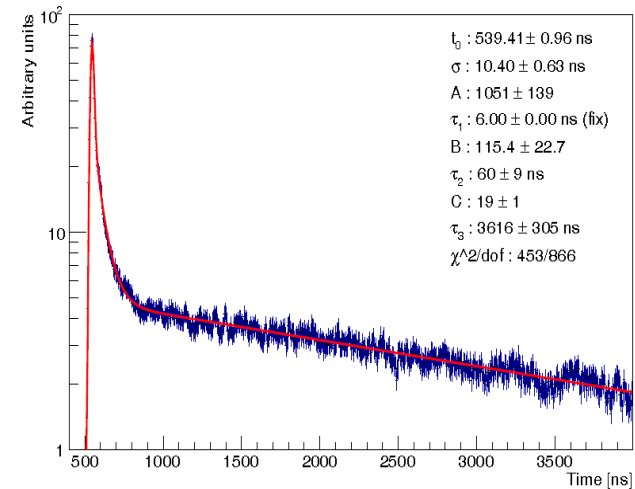

Scintillation light (slow component) in pure argon gas

Detector–Cryostat integration

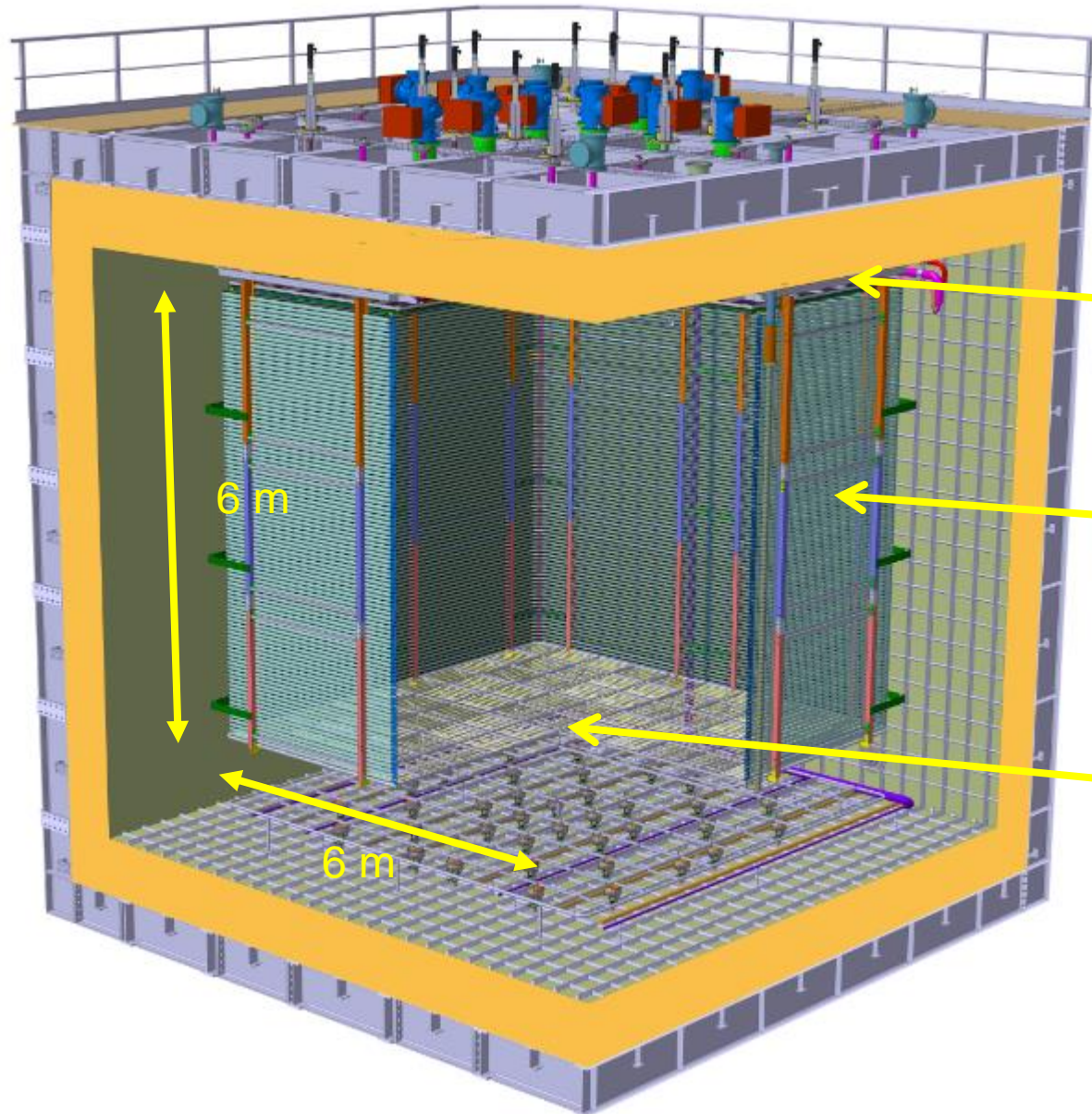

→ Finalization by the end of November 2016 of executive design of: CRPs, field-cage and cathode

Charge Readout Planes

Field Cage (common structural elements with SP)

Cathode

Full 3D electrostatic simulations completed for HV feedthrough, field-cage, cathode, ground grid

The Dual-Phase ProtoDUNE/WA105 6x6x6 m³ detector is built out of the same **3x3m² Charge Readout Plane units (CRP)** foreseen for the 10 kton Dual-Phase DUNE Far Detector (same QA/QC and installation chains)

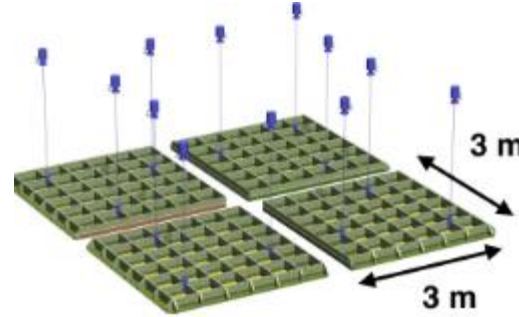
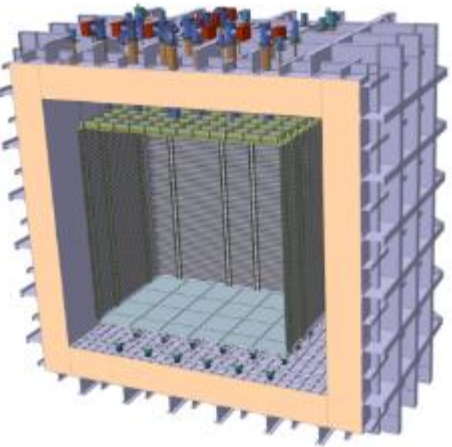

WA105: 4 CRP

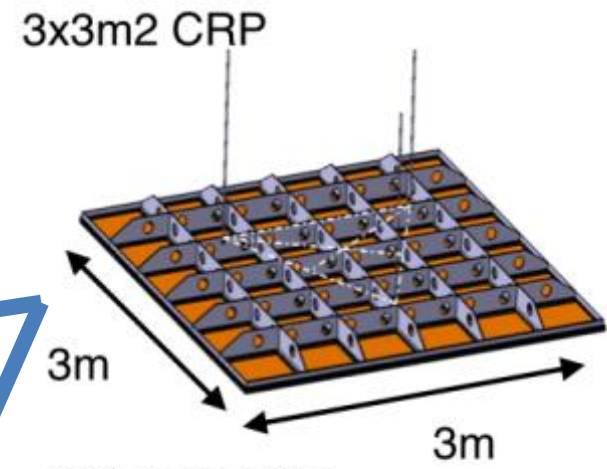

1920 channels/CRP
Accessible cold electronics in chimney

10 kton: 80 CRP

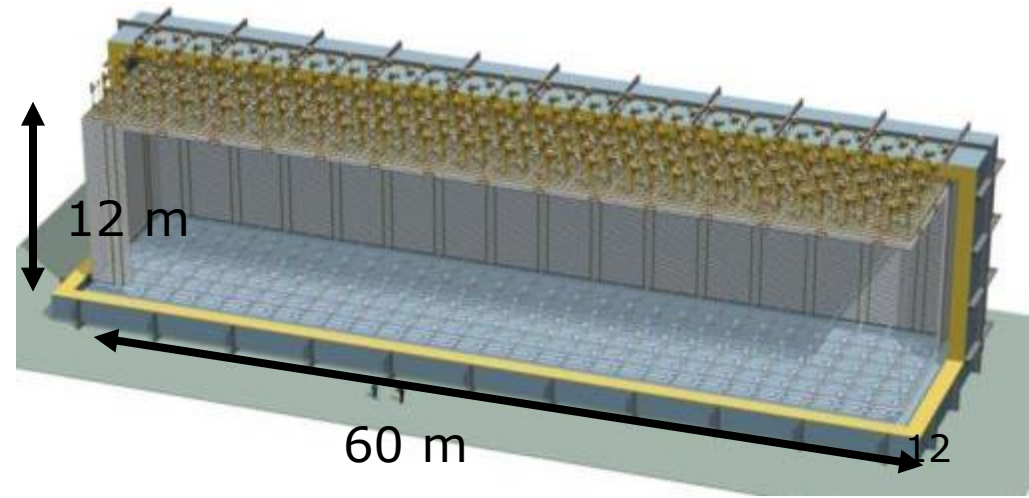
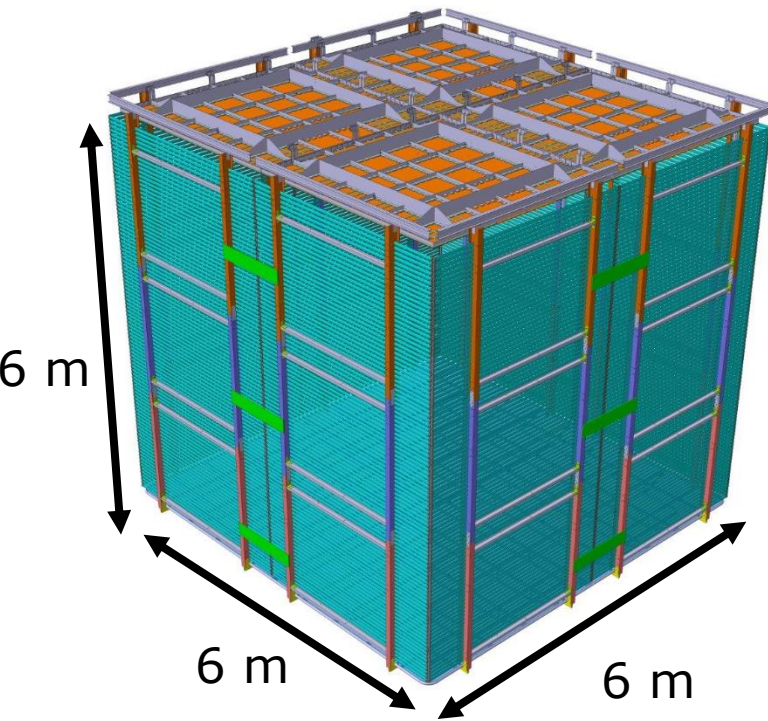

3x3 m² CRPs integrating the LEM-anode sandwiches (50x50 cm²) and their suspension feedthroughs (CRP specific to dual-phase technology: critical item)

→ Invar frame + decoupling mechanisms in assembly in order to ensure planarity conditions ± 0.5 mm (gravity, temperature gradient) over the 3x3 m² surface which incorporates composite materials and ensure minimal dead space in between CRPs

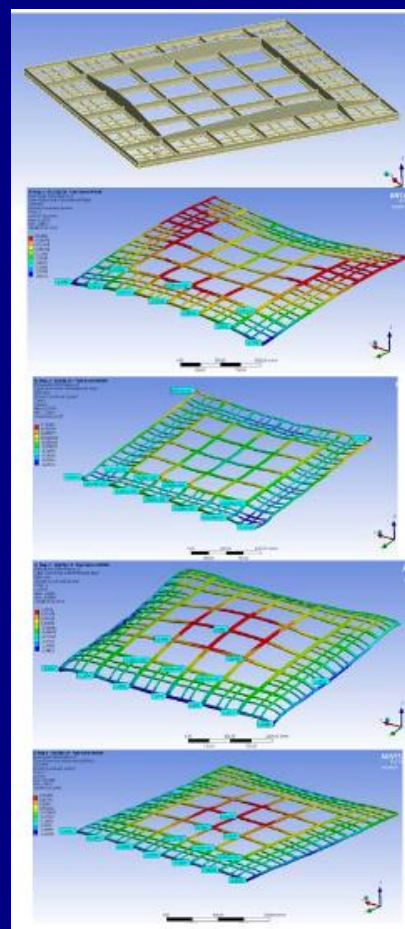
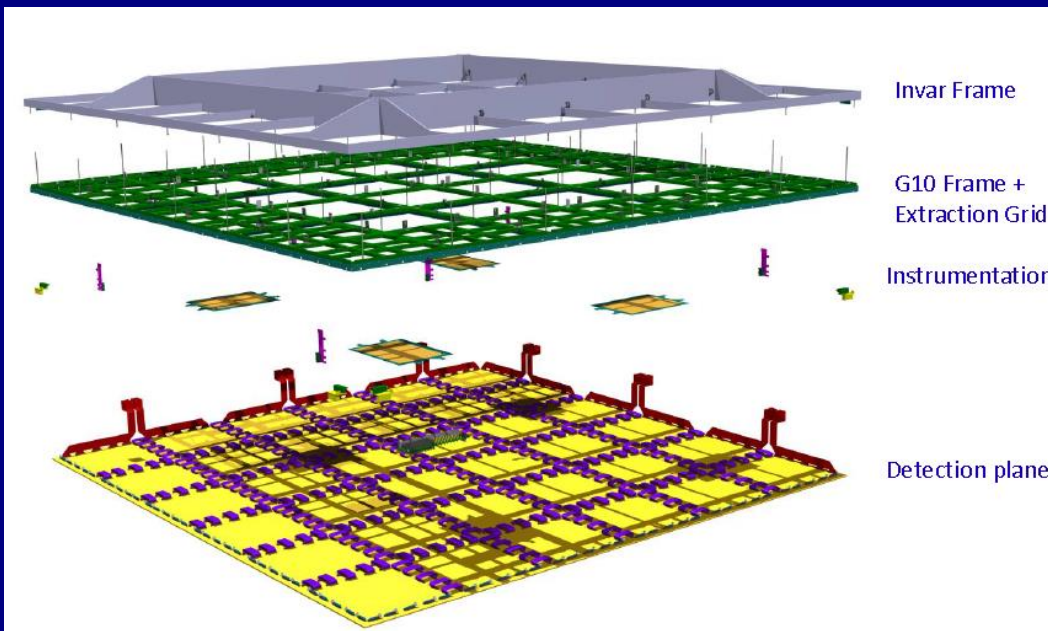

CRP mechanical structure design:

→ campaign of cold bath tests + photogrammetry on differential effects in thermal contraction, design of decoupling mechanism



Thermal decoupling supports of G10 frame on invar frame

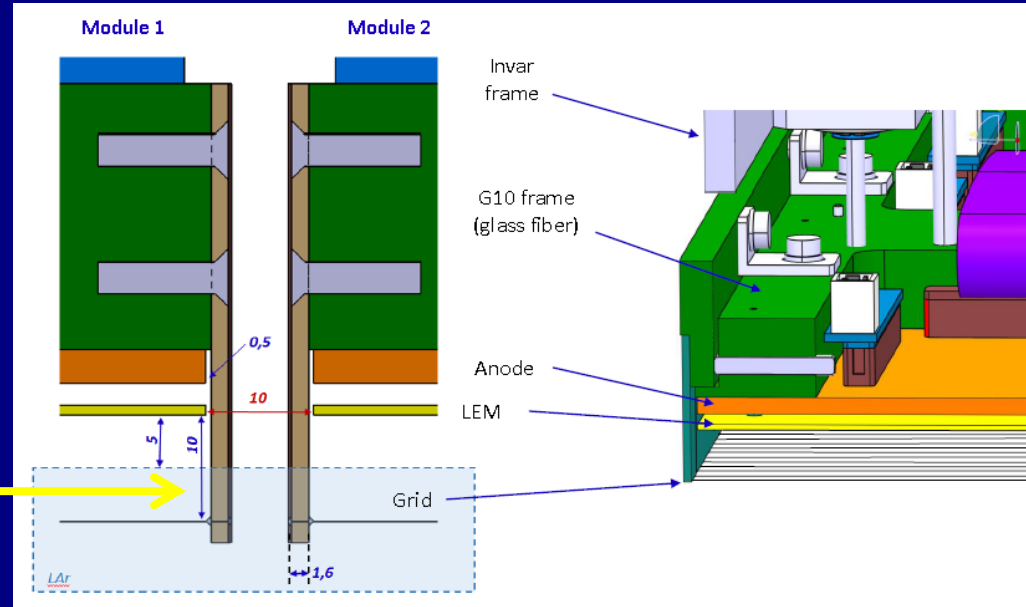

Integration of the grid of submerged extraction wires in the frame minimizing dead space in between CRPs. Tests for the wires system design

Tooling, assembly and installation procedures defined → getting ready for production

CRP assembly animation:
<https://youtu.be/jcnJjIU-Cyc>

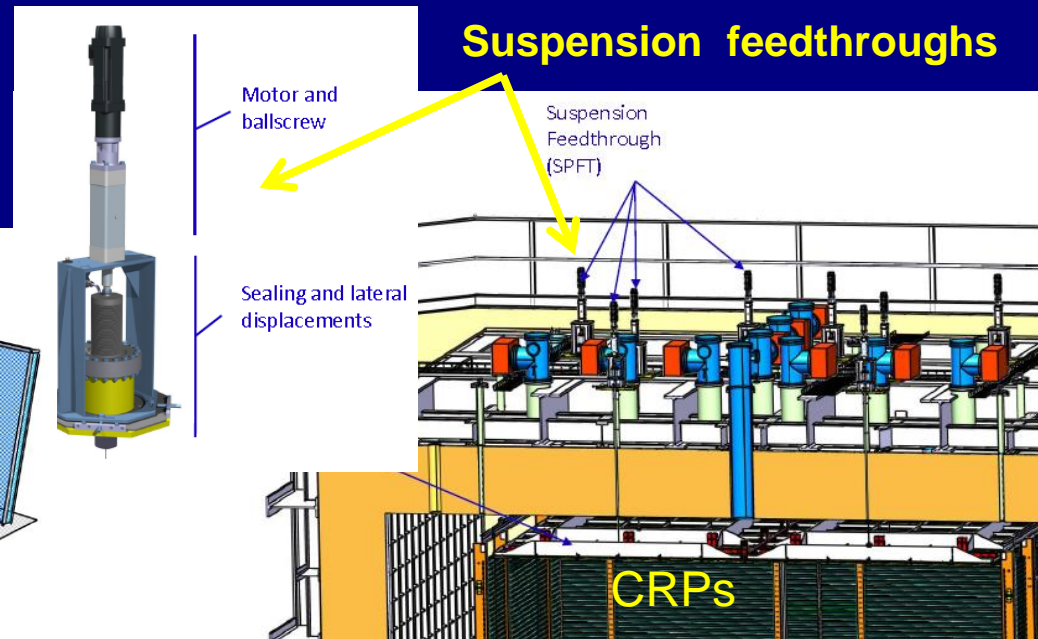
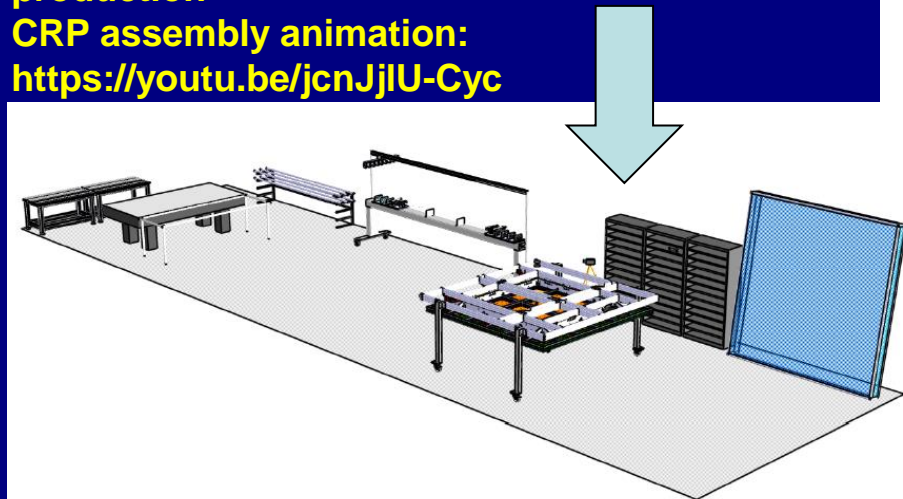

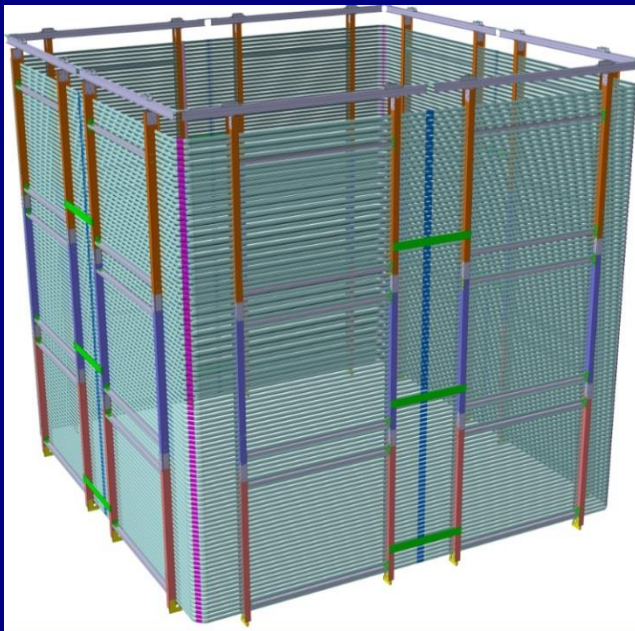

Field cage shares common basic structural elements (extruded profiles and FRP beams) with the single-phase ProtoDUNE

Assembled in 8 vertical modules of 6238x3017 mm (2 modules per detector face).

Each module is assembled out of 3 sub-modules

→ 98 profiles/module with 60 mm pitch

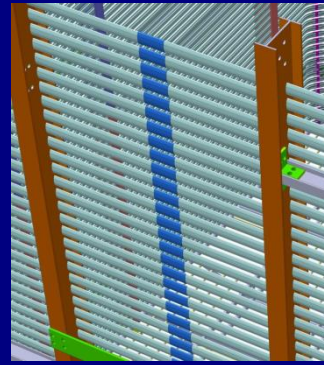
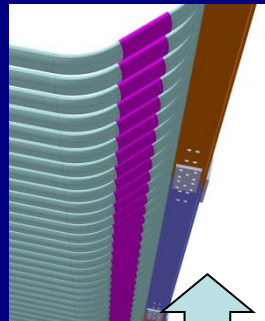
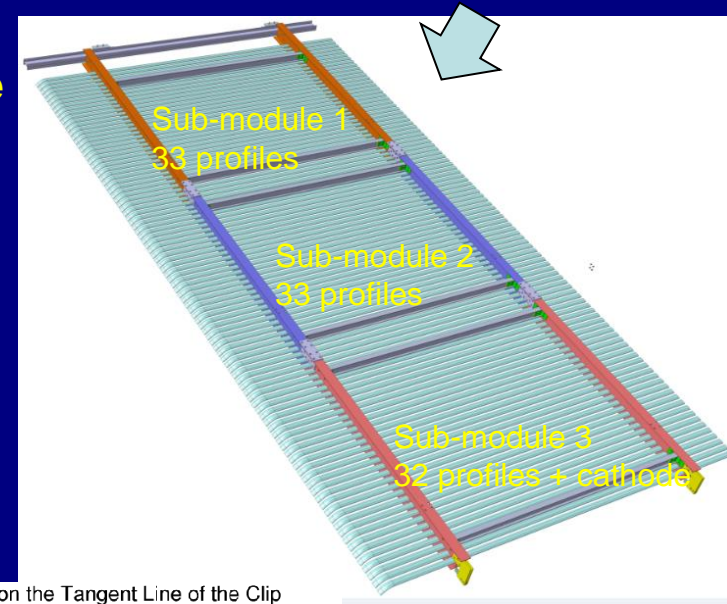

Continuity at center and borders (bent at 45 degrees) with clipping profiles

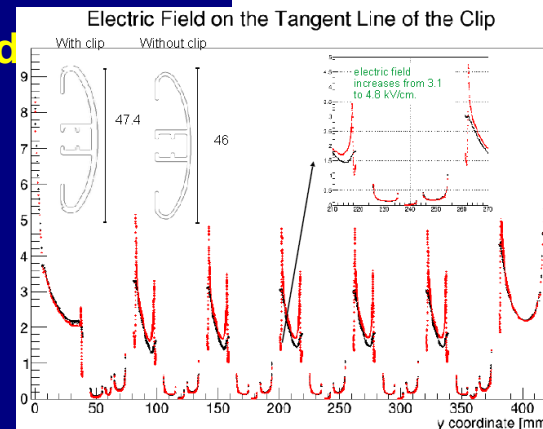

Detailed electrostatic simulations performed for profiles/clips

Test setup at CERN for clips and electrical elements

- Adaptation from SP beam plug design being finalized

Transparent cathode with ITO (Indium-Tin-Oxyde) **resistive coating** on two sides of PMMA plates + TPB deposition at the top side:

- R&D and conceptual design for plates integration in cathode structure completed
- Infrastructure set up for TPB evaporation coating
- Tested ITO coated PMMA plates up to 850x600 mm² (produced by industry) → chosen size 650x650x10 mm³

LBNC meeting of October 2016: PMMA cathode, despite all successful R&D, introduces many elements of novelty in the 6x6x6 design and possibly some risks which will not be retired by the 3x1x1 operation

→ **decided to reactivate the baseline design of the cathode, based on a mesh of pipes (extensively studied in the LAGUNA-LBNO DS and WA105 TDR)**

→ **Minimal changes to the structure made for PMMA inserting 20 mm SS pipes with 105 cm pitch, completion of executive design, full simulations showing $E < 30$ kV/cm**

Ground grid above the PMTs, 2mm wires embedded in a SS frame 40/20 mm pipes, assembled in 4 modules

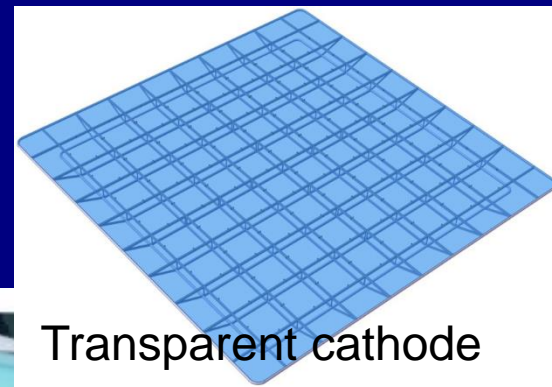

Transparent cathode

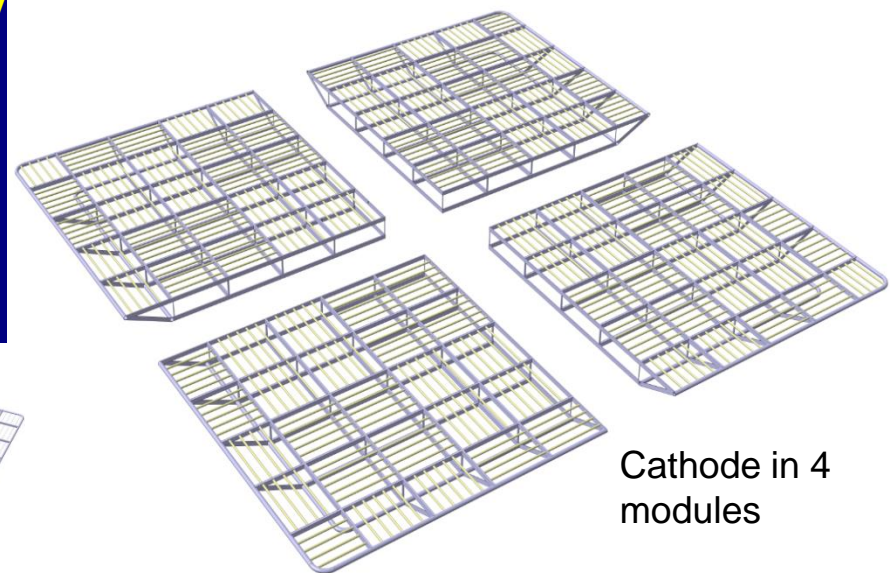
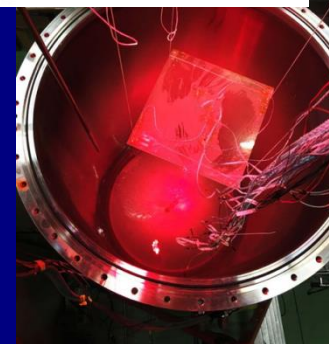
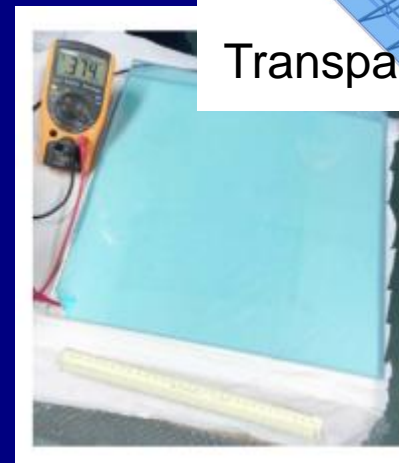

Cathode in 4 modules

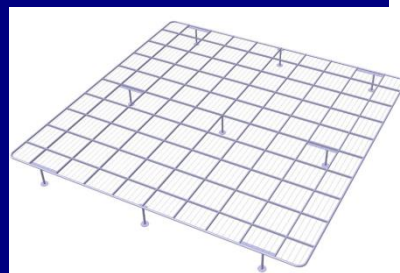

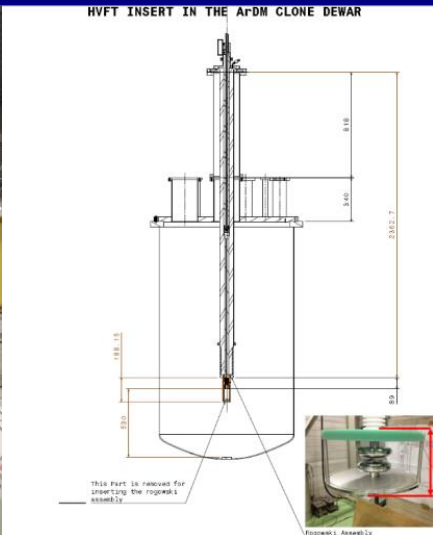

Cathode HV system:

- HV power supply for 300 kV already available Heinzinger
- HV feedthrough deployed on 3x1x1 but designed to work up to 300 kV (300 kV milestone achieved in September in dedicated test setup, article: C. Cantini et al 2017 JINST 12 P03021.)

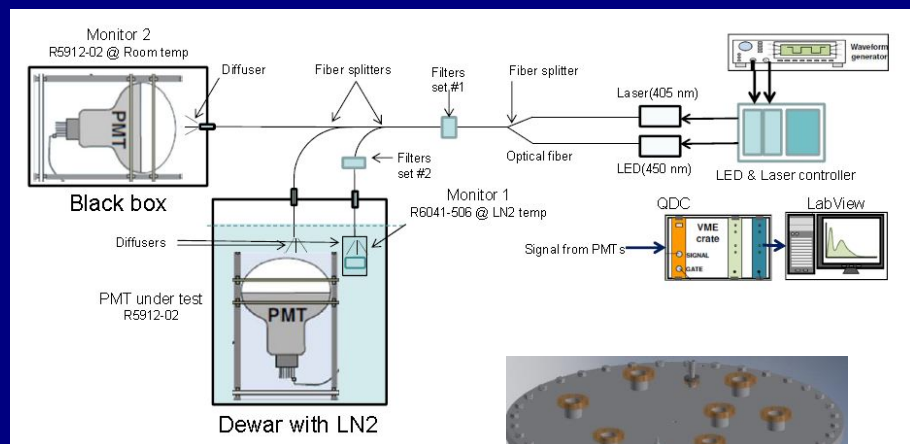

Preparation for PMTs installation:

- 40 PMTs procured in December 2016
- Calibration/characterization system at warm/cold
- TPB coating at CERN (Icarus facility)

Cryostat for test in batches of 10 PMTs (April 2017)

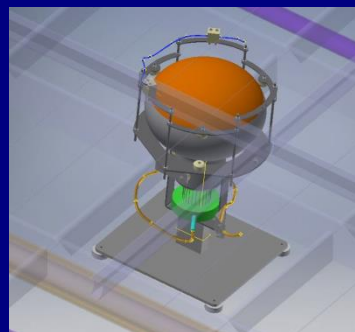
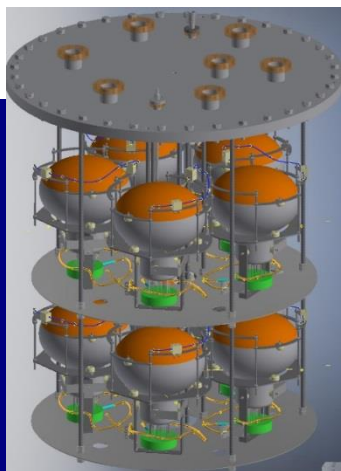

Mechanical supports for installation on the cryostat floor in between corrugations (arrangement compatible with cryo-piping)

DETECTOR OVERVIEW

- Top FTs
- Internal Cable Trays
- 4 x Purity Monitor
- Internal Cryogenic piping
- Beam Plug
- HVFT degrader

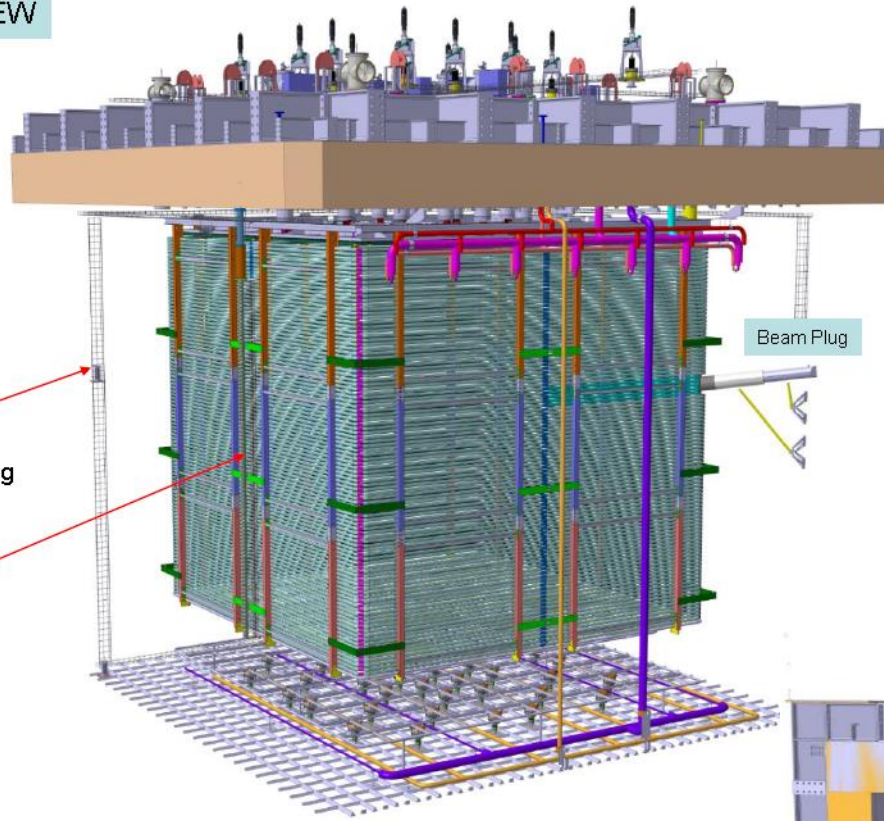

- Global detector integration performed as well as precise definition of mounting operations
- Assembly procedures and transportation boxes defined to be compatible with 10 kton assembly at LBNF

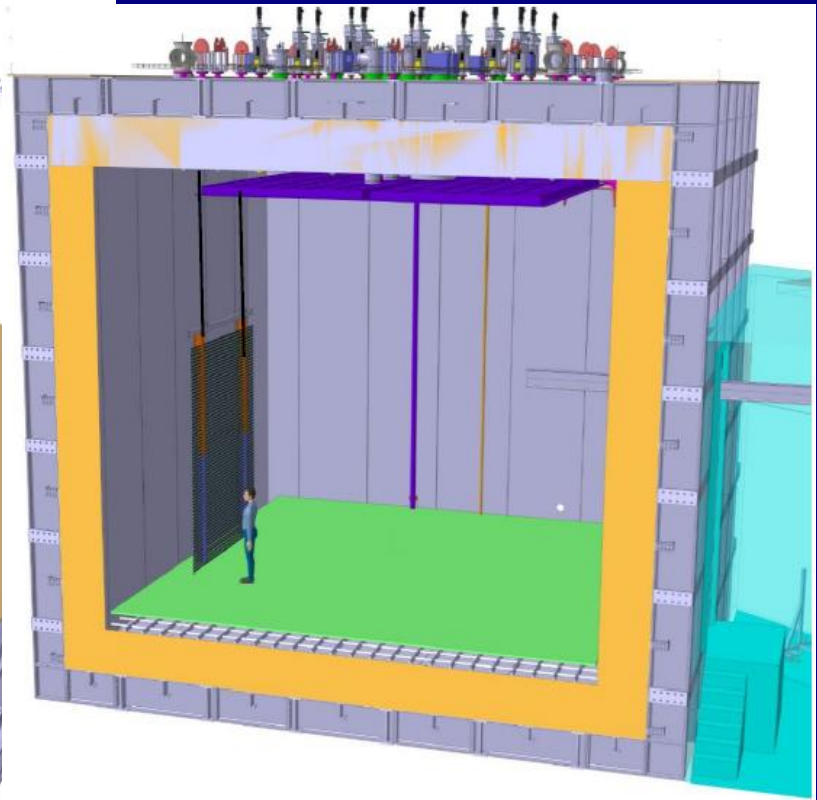
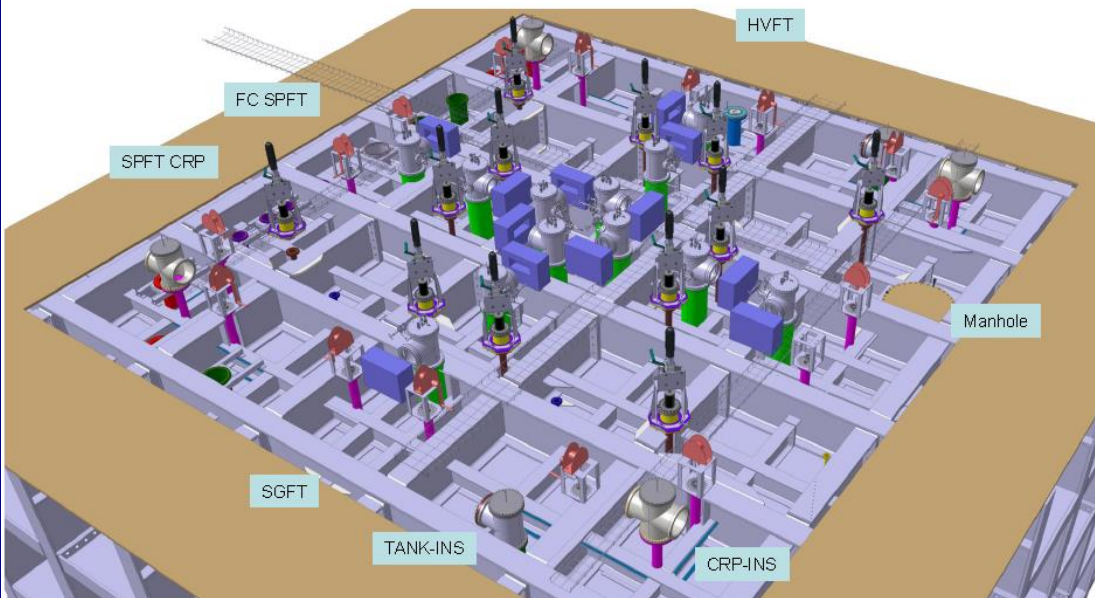



Slide from LBNC review in October

- Extension of North Area completed !
- Cryostat construction started → Available for WA105 installation in April 2015

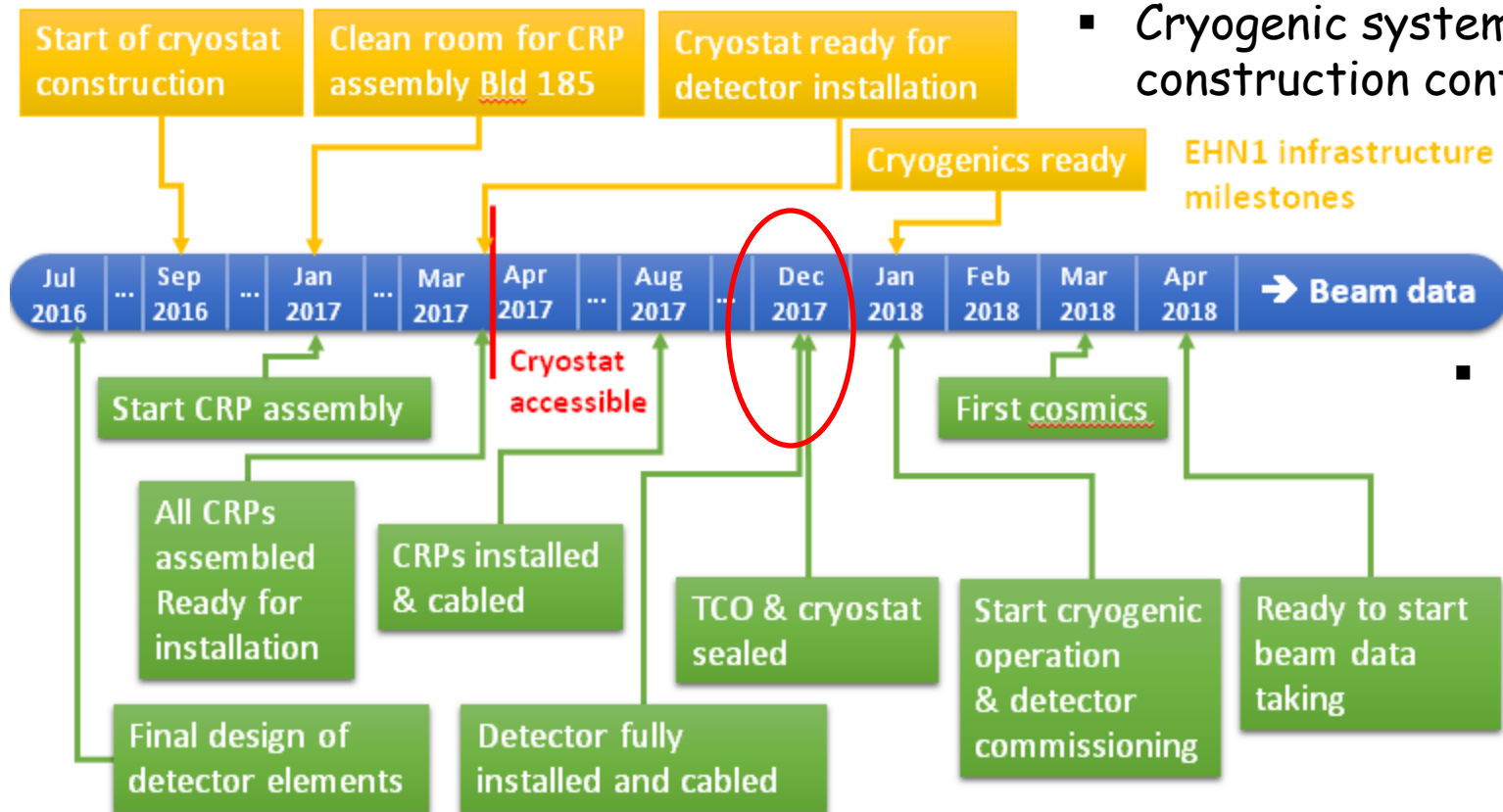

- Cryogenic system designed and construction contract assigned

- Detector installation expected to be completed by Dec 2017



September 2016



→ Now:

- exoskeleton cryostat installation completed
- insulation panels installation started to be completed by the end of May

- Clean Room in hall 185, used so far by Icarus, freed on April 7th in order to host the CRP assembly activities
- Cryostat + clean room buffer should become available in June to start the detector installation activities
- Assembly/procurement activities started

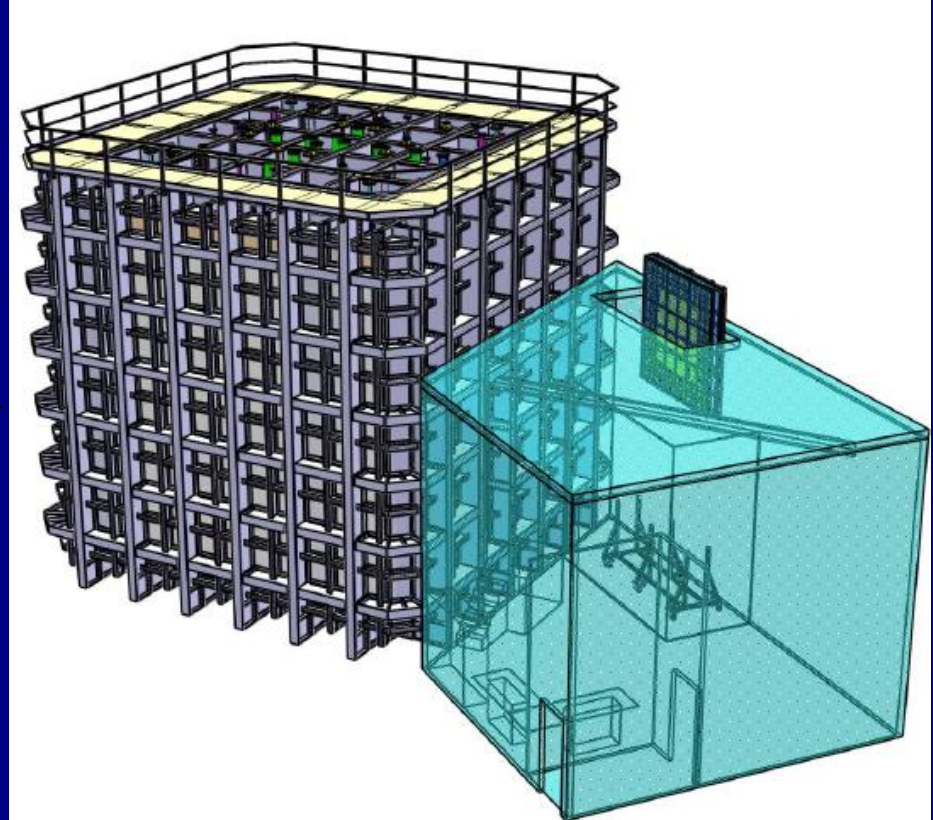
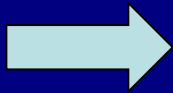

Schedule revision including:

- information from the availability of the infrastructure
- detector executive design (CRP, field cage, cathode) related to a more precise definition of the construction and assembly procedures
- refinements related to experience from the 3x1x1
- Procurement/tendering follow-up

→ end of detector installation 6 April 2018

Overall close coordination among EHN1 and two ProtoDUNES needed during assembly (as recommended by SPSC)

- Access to clean room in Hall 185 11/4/2017
- Access to cryostat/clean room buffer in EHN1 to start the detector installation 1/6/2017
- First CRP installed 3/10/2017
- All CRPs installed and cabled 17/1/2018
- End of readout electronics installation 9/2/2018
- End of drift cage and cathode installation
- End of beam-plug installation 5/3/2018
- End of PMTs installation 4/4/2018
- Detector fully installed/cabled , ready to seal TCO 6/4/2018

Dedicated assembly/installation WG in strict contact with neutrino platform people

H2-VLE beamline

Tertiary beam on H2 beamline:
1-12 GeV/c, momentum bite 5% (can be reduced to 1% with integrated spectrometer measurements)

EHN1 Extension - H2 VLE Beam Schematic Layout

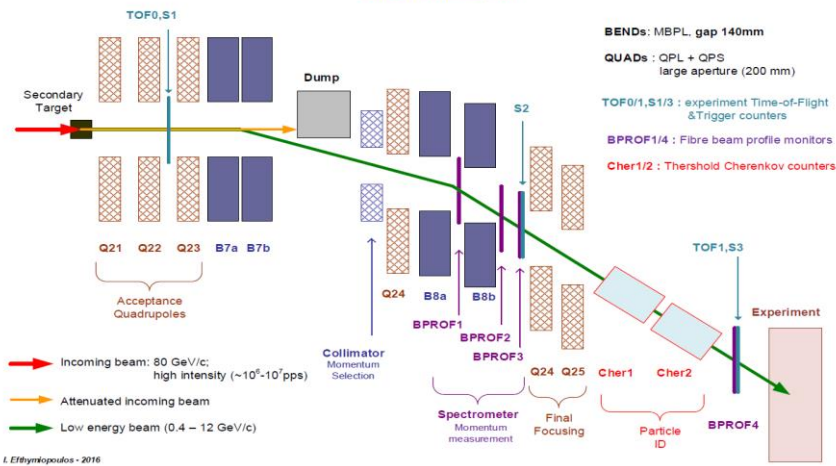

- **Mixed hadrons beam 1-12 GeV/c: pions, kaons, protons + electrons contamination at low energies**
- **Pure electron beams**
- **Parasitic muon halo**

→ O(100 M beam triggers to be acquired in 2018 in 120 days of beam operation)

Beam instrumentation well defined by B.I. WG (beam profile monitors and trigger tiles TOF, 2 Cerenkov)

Beam line with all instrumentation integrated



Integration of beam-line DAQ within WA105 White-Rabbit time distribution system

Construction started → looking forward to commissioning

Momentum [GeV/c]	anti-p	e-	e+	K-	K+	mu-	mu+	p	pi-	pi+
0.4	0.00%	0.00%	97.61%	0.00%	0.00%	0.00%	0.00%	0.48%	0.00%	1.91%
1	0.00%	0.00%	74.20%	0.00%	0.00%	0.00%	0.00%	14.94%	0.00%	10.86%
2	0.00%	0.00%	45.83%	0.00%	0.67%	0.00%	0.96%	20.04%	0.00%	32.50%
3	0.00%	0.00%	68.29%	0.00%	0.64%	0.00%	0.42%	7.72%	0.00%	22.94%
4	0.00%	0.00%	53.72%	0.00%	1.46%	0.00%	0.65%	7.56%	0.00%	36.61%
5	0.00%	0.00%	42.38%	0.00%	2.47%	0.00%	0.83%	9.18%	0.00%	45.14%
6	0.00%	0.00%	31.42%	0.00%	3.83%	0.00%	0.73%	10.10%	0.00%	53.92%
7	0.00%	0.00%	24.70%	0.00%	4.08%	0.00%	0.85%	9.92%	0.00%	60.46%
8	0.00%	0.00%	19.36%	0.00%	5.11%	0.00%	0.97%	11.33%	0.00%	63.24%
9	0.00%	0.00%	15.12%	0.00%	5.67%	0.00%	0.82%	11.10%	0.00%	67.29%
10	0.00%	0.00%	12.36%	0.00%	6.02%	0.00%	0.71%	12.25%	0.00%	68.66%
11	0.00%	0.00%	10.46%	0.00%	6.95%	0.00%	0.82%	13.57%	0.00%	68.20%
12	0.00%	0.00%	8.90%	0.00%	6.89%	0.00%	0.66%	14.26%	0.00%	69.30%

Tertiary Beam composition for secondary beam +80 GeV/c

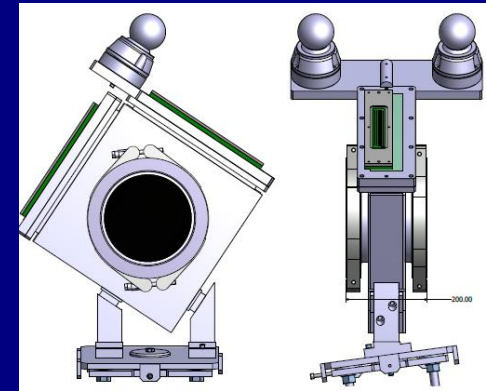

Final PID scheme:

- TOF with BPROF's – distance ~32 m
- 1 "low pressure" XCET - < 3bar pressure ("C1")
- 1 "high pressure" XCET - ≥ 15 bar pressure ("C2")

BPROF's 1 mm fibers pitch
2 mm thick scintillator tiles

Momentum (GeV/c) / Particle	e	π	K	p
0.4 - 3.0	C1 CO2 @ 1bar	TOF	0	TOF
3.0 - 5	C1 CO2 @ 1bar	C2 CO2 @ 3.5 bar	No C2	No C2
5.0 - 12.0		C1 CO2 @ 1bar	C2 CO2 @ ≤ 14bar	No C1 No C2

Baseline : No K/p separation between 3 - 5 GeV
No e- tagging in the 'high energy' regime 5-12 GeV

WA105 Accessible cold front-end electronics and uTCA DAQ system 7680 ch

Full accessibility provided by the double-phase charge readout at the top of the detector

➤ Digital electronics at warm on the tank deck: ➤ Cryogenic ASIC amplifiers (CMOS 0.35um) 16ch externally accessible:

- Architecture based on uTCA standard
- 1 crate/signal chimney, 640 channels/crate
- 12 uTCA crates, 10 AMC cards/crate, 64 ch/card

- Working at 110K at the bottom of the signal chimneys
- Cards fixed to a plug accessible from outside
- Short cables capacitance, low noise at low T

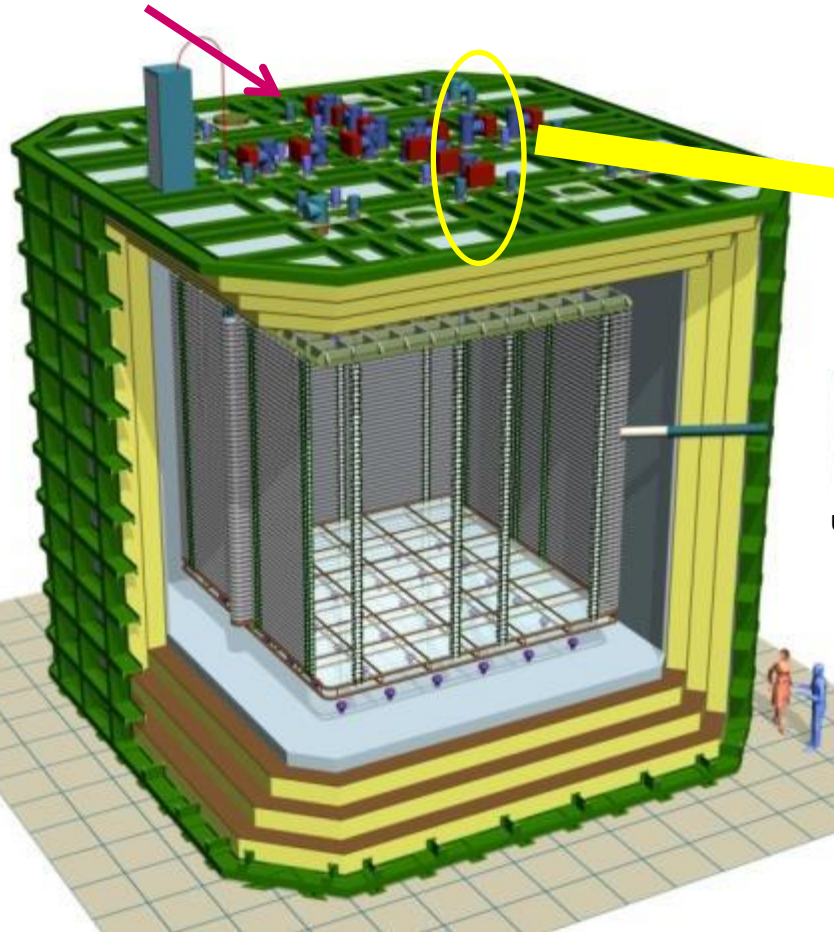

Signal chimney

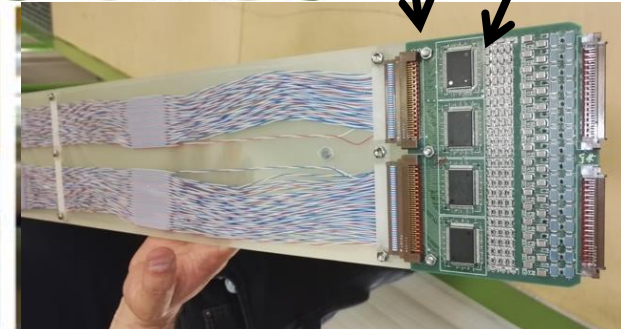
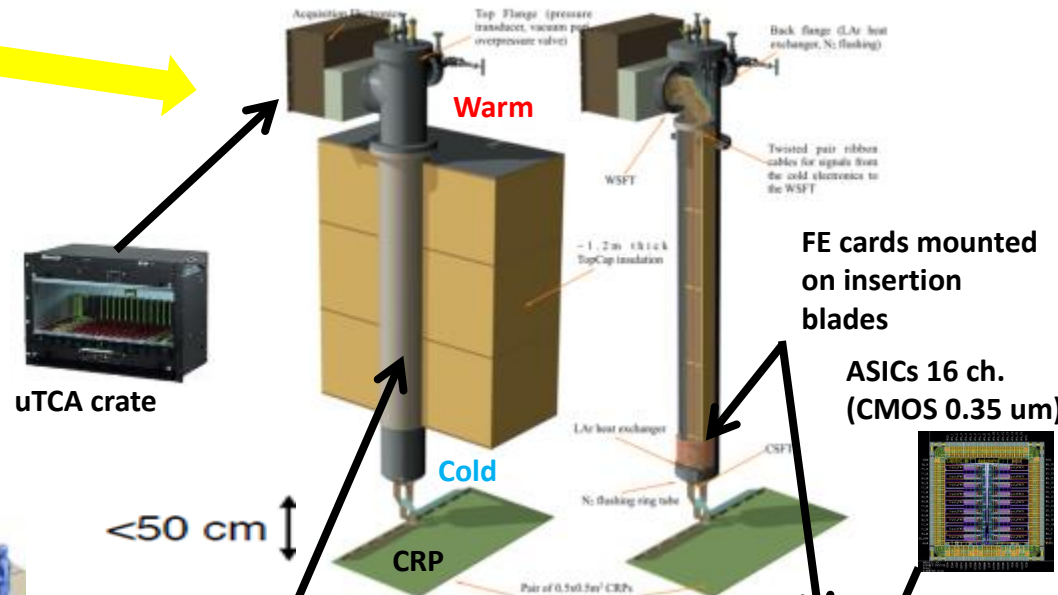

Cost effective and fully accessible cold front-end electronics and DAQ

Ongoing R&D since 2006 → in production for 6x6x6 (7680 readout channels)

ASIC (CMOS 0.35 μm) 16 ch. amplifiers working at $\sim 110\text{ K}$ to profit from minimal noise conditions:

- FE electronics inside chimneys, cards fixed to a plug accessible from outside
- Distance cards-CRP < 50 cm
- Dynamic range 40 mips, (1200 fC) (LEM gain = 20)
- 1300 e⁻ ENC @ 250 pF, < 100 keV sensitivity
- Single and double-slope versions
- Power consumption < 18 mW/ch
- Produced at the end of 2015 in 700 units (entire 6x6x6)
- 1280 channels installed on 3x1x1

DAQ in warm zone on the tank deck:

- Architecture based on uTCA standard
- Local processors replaced by virtual processors emulated in low cost FPGAs (NIOS)
- Integration of the time distribution chain (improved PTP)
- Bittware S5-PCIe-HQ 10 Gbe backend with OPENCL and high computing power in FPGAs
- Production of uTCA cards started at the end of 2015, pre-batch already deployed on 3x1x1

→ Large scalability (150k channels for 10kton) at low costs

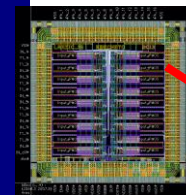
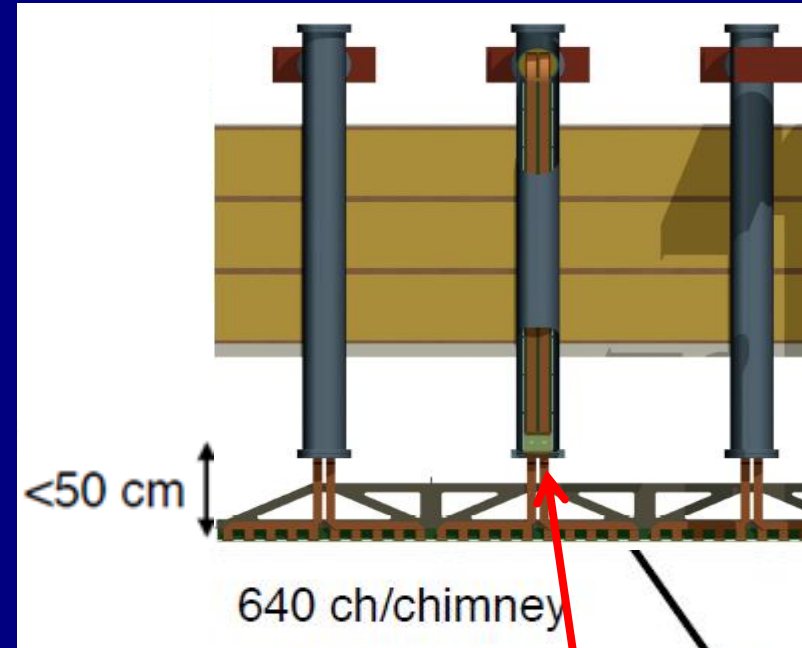

ASIC 16 ch.
CMOS 0.35 μm

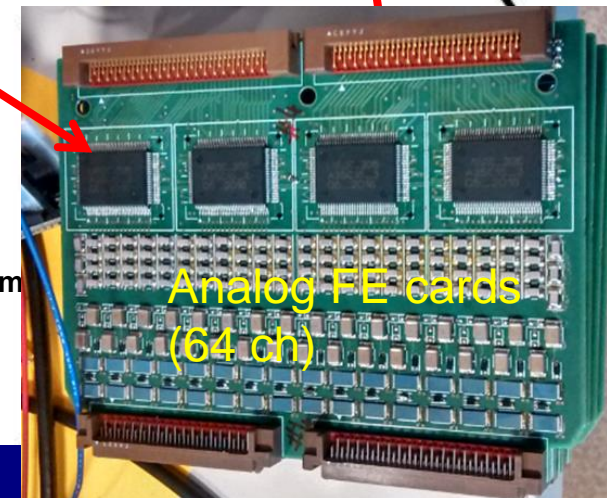

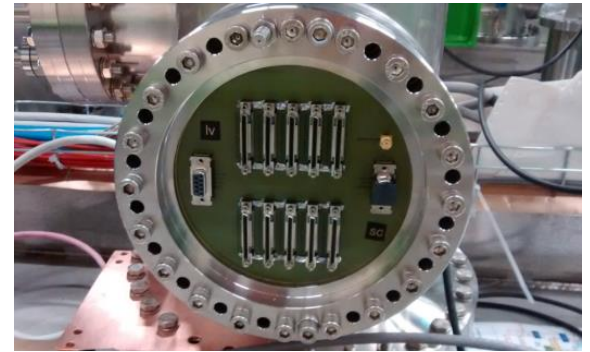
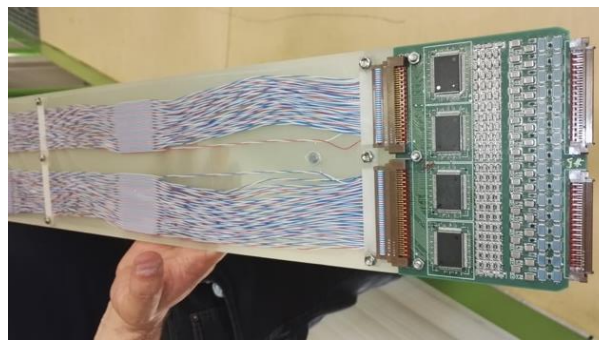

- Full production 700 chips of cryogenic ASIC amplifiers procured at the beginning of 2016
- 64 channels FE cards with 4 cryogenic ASIC amplifiers designed and tested in the spring 2016
- First batch of 20 cards (1280 channels) produced for the 3x1x1 operation, operational

uTCA 64 channels AMC digitization cards (2.5-25 MHz, 12 bits output, 10 GbE connectivity)

- 20 cards produced by September 2016 to equip the 3x1x1, operational
- Cards production going to be completed with the 2017 budget of remaining 100 FE and uTCA cards for 6x6x6 (main components purchased last year ADCs,FPGAs,IDT memories ...)



Global uTCA DAQ architecture

integrated with « White Rabbit » (WR) Time and Trigger distribution network
+ White Rabbit slaves nodes in uTCA crates +
WR system (time source, GM, trigger system, slaves)

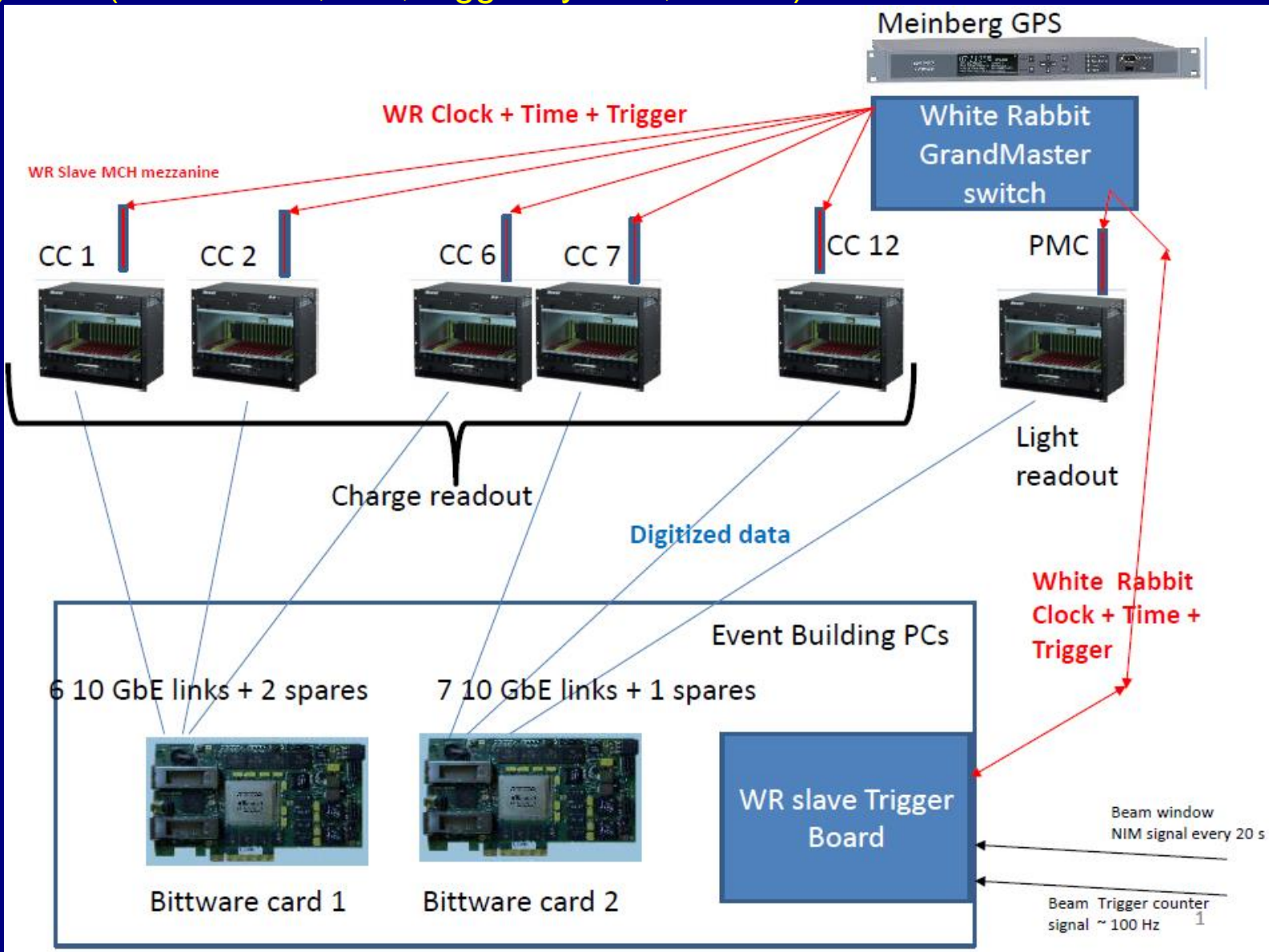



White Rabbit trigger time-stamping PC (SPEC + FMC-DIO)
 White Rabbit Grand-Master
 GPS unit

White Rabbit scheme

- WR is an evolution of the synchronization scheme based on **synchronous Ethernet + PTP** which was previously developed at IPNL in 2008: <http://arxiv.org/abs/0906.2325>
- WR is accurate at sub-ns level, enough to align the 400ns samples
- At the level of the charge readout DAQ is distributed the beam trigger timestamp.
- Trigger time info starts and closes the acquisition of the samples belonging to the drift window of an event in each AMC (important when operating without ZS).
- The beam trigger can be time-stamped on the PC trigger board and be broadcasted to the microTCA crates via the WR time distribution network



Meinberg MASTER + WR switch + slave node

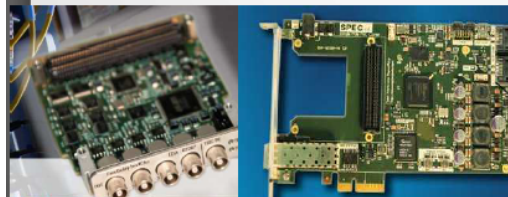

FMC Fine Delay 1 ns 4 channels

SPEC FMC PCIe carrier V4

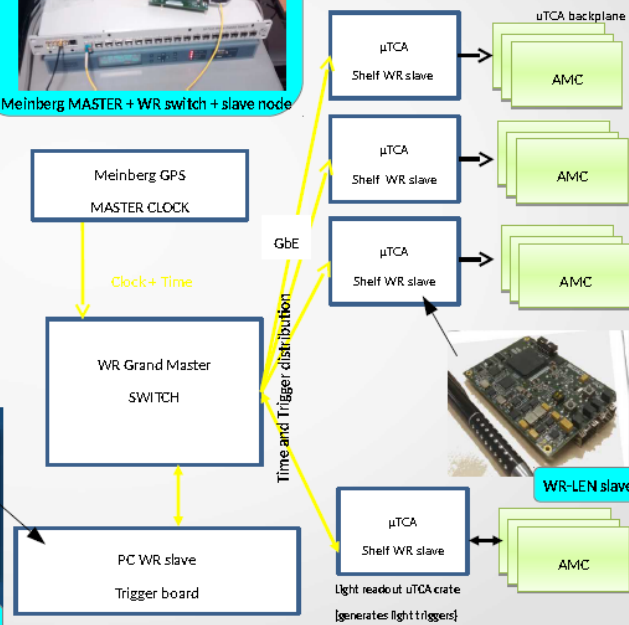

Clock + time
 + trigger data on
 uTCA backplane

WR-LEN slave

Light readout uTCA crate
 [generates light triggers]

White Rabbit uTCA slave node based on WRLEN developed and produced for entire 6x6x6

Other components of the chain (GPS receiver, WR grandmaster, SPEC+ FMC-DIO + 13 WRLEN) available commercially



6x6x6: 12 uTCA crates (120 AMCs, 7680 readout channels)

→ 3x1x1: 4 uTCA crates (20 AMCs, 1280 readout channels)

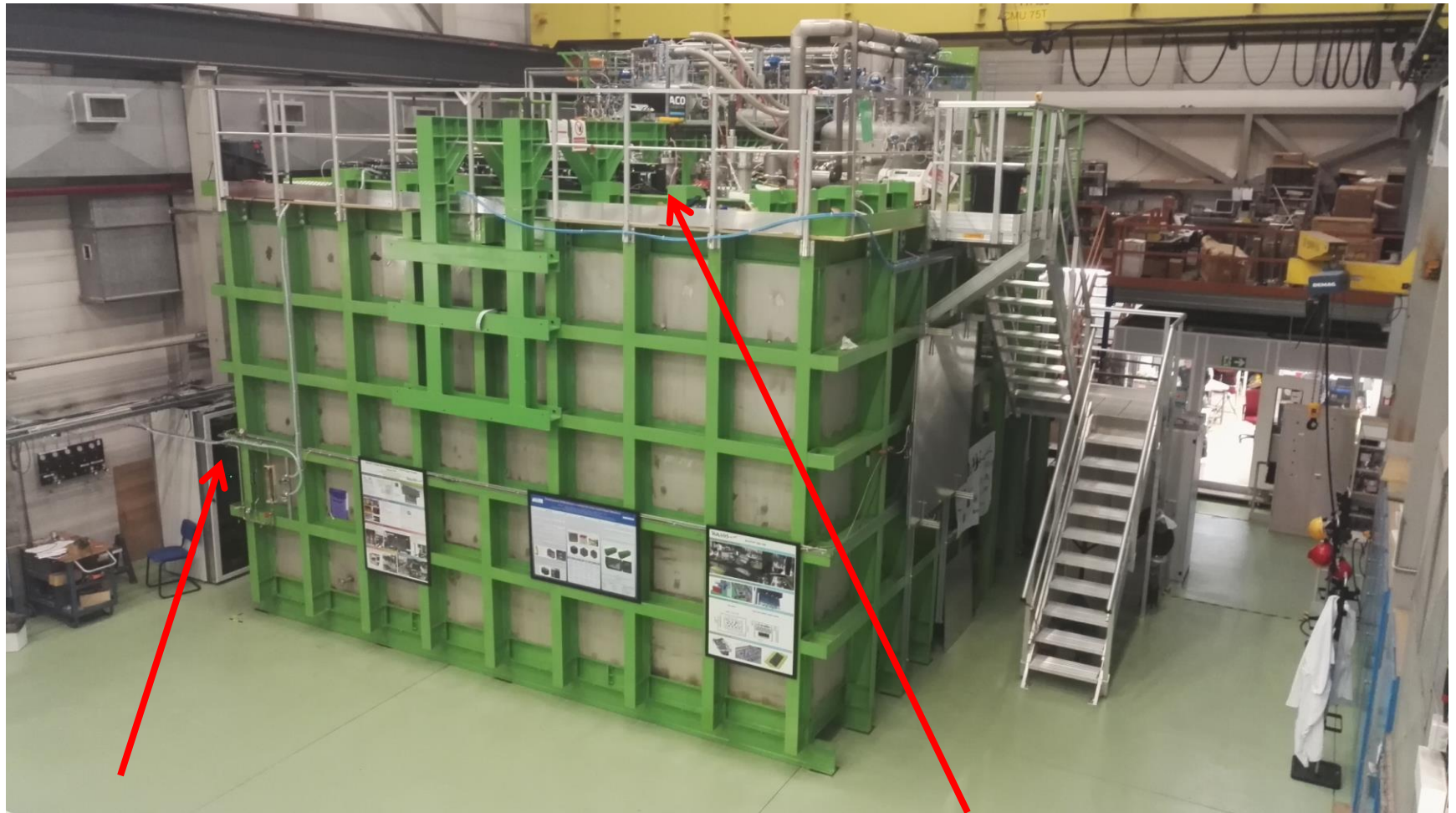

Event builder, network, GPS/White Rabbit GM,
WR Trigger PC

Signal Chimneys and uTCA crates

How a crates was looking like before VHDCI signals cabling to the warm flange

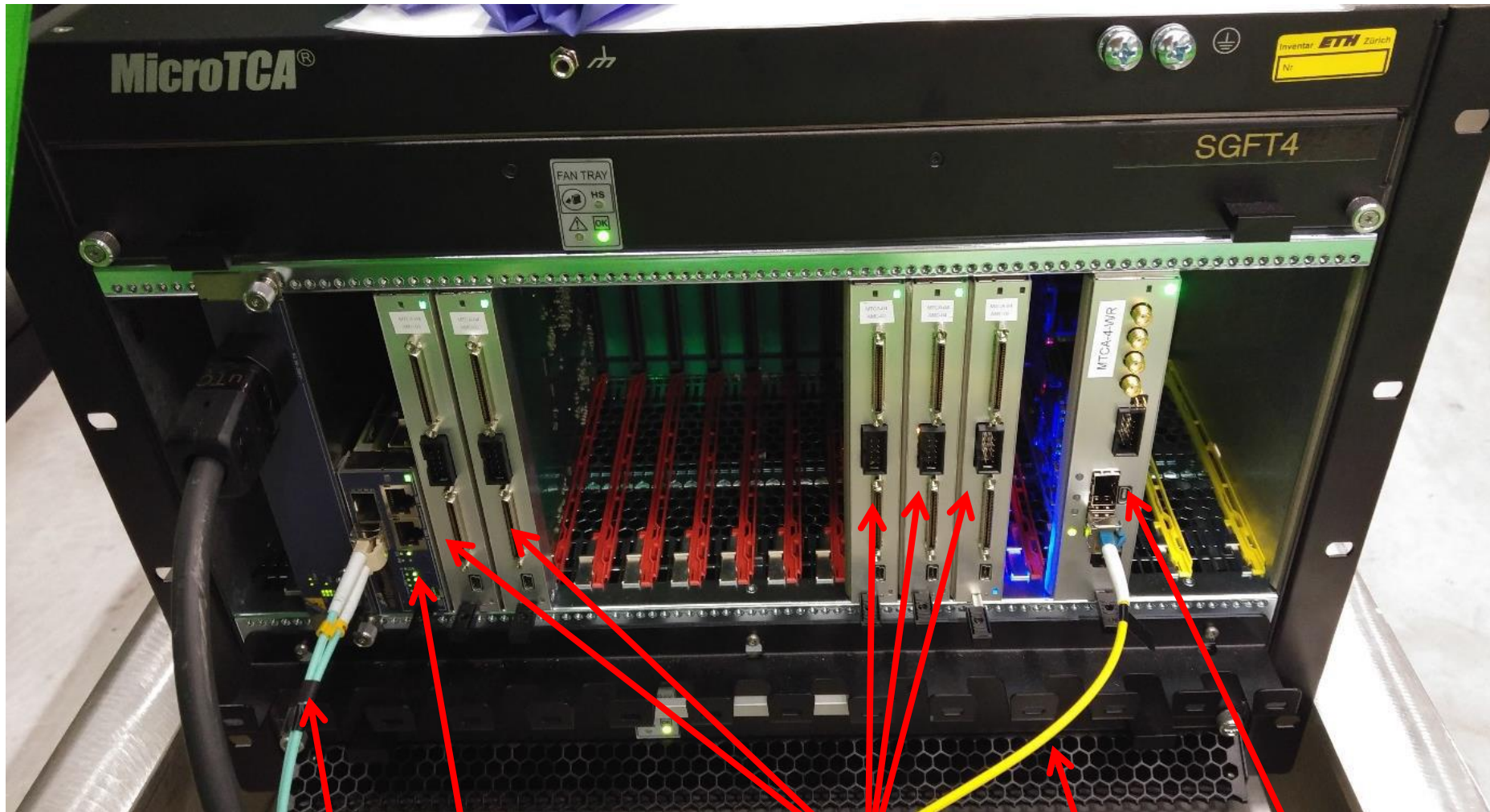

10 Gbit/s data link

MCH

AMC 64 channels
digitization cards

White Rabbit optical link

WR uTCA slave
card node with
WRLEN mezzanine

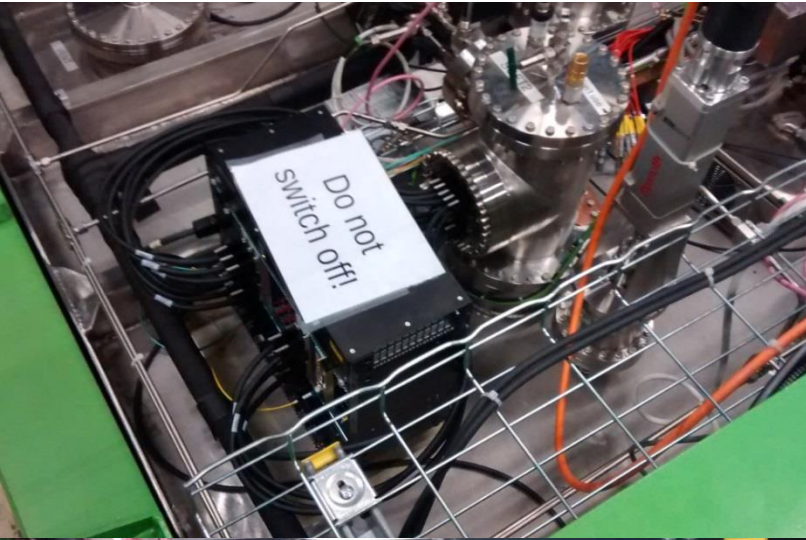

Top cap picture with uTCA crates cabled to signal chimneys



Applications Places System Fri Dec 2, 8:51 AM root

TigerVNC: wa105ss04.cern.ch:1 (shift) (on wa105cpu0000.cern.ch)

Applications Places System Fri Dec 2, 8:51 AM shift

LArGUI

UNIT ID	IP	STATUS	ERROR
0 (Trig)	10.11.40.202	STOP	0
5 (0-1)	10.11.40.146	OK	0
4 (0-2)	10.11.40.147	OK	0
3 (0-3)	10.11.40.148	OK	0
2 (0-10)	10.11.40.155	OK	0
1 (0-11)	10.11.40.156	OK	0
11 (2-1)	10.11.40.158	OK	0
12 (2-2)	10.11.40.159	OK	0
13 (2-3)	10.11.40.160	OK	0
14 (2-10)	10.11.40.167	OK	0
15 (2-11)	10.11.40.168	OK	0
6 (1-1)	10.11.40.170	OK	0
7 (1-2)	10.11.40.171	OK	0
8 (1-3)	10.11.40.172	OK	0
9 (1-10)	10.11.40.179	OK	0
10 (1-11)	10.11.40.180	OK	0
16 (3-1)	10.11.40.182	OK	0
17 (3-2)	10.11.40.183	OK	0
18 (3-9)	10.11.40.190	OK	0
19 (3-10)	10.11.40.191	OK	0
20 (3-11)	10.11.40.192	OK	0

Start Stop

Run

243 DATA ACQUISITIO

Events/File

335 NO COMPRESSION

Current datatitle

Current event

0

```
[02/12/16 08:50:31] > Initialise data path to : /mnt/wa105raid4/LArData
[02/12/16 08:50:31] > LArUnit:runEventLoop 19: stop for shutdown...
[02/12/16 08:50:31] > Read configuration file: 20 units(s)
[02/12/16 08:50:31] > Manager: init done
```

Reinit Board Refresh infos

shift@wa105cpu0000... [evtbd@wa105ss04:~... shift@wa105cpu0000... WA105 Event Display TigerVNC: wa105ss04...

Run control with 20 AMCs



Automatic data processing on online storage/processing farm for purity and gain analysis + data transfer on EOS

Stable system, noise conditions at warm 1.5-1.7 ADC counts RMS

Several campaigns of checking of the grounding conditions/noise measurements since June 2016.

Good noise conditions with some residual small issues related to slow-control/HV grounding and cabling

→ Average RMS noise 1.7 ADC counts (0.82 mV) at warm with all systems active and cabled 1.5 ADC counts with slow control/HV cables disconnected from flanges

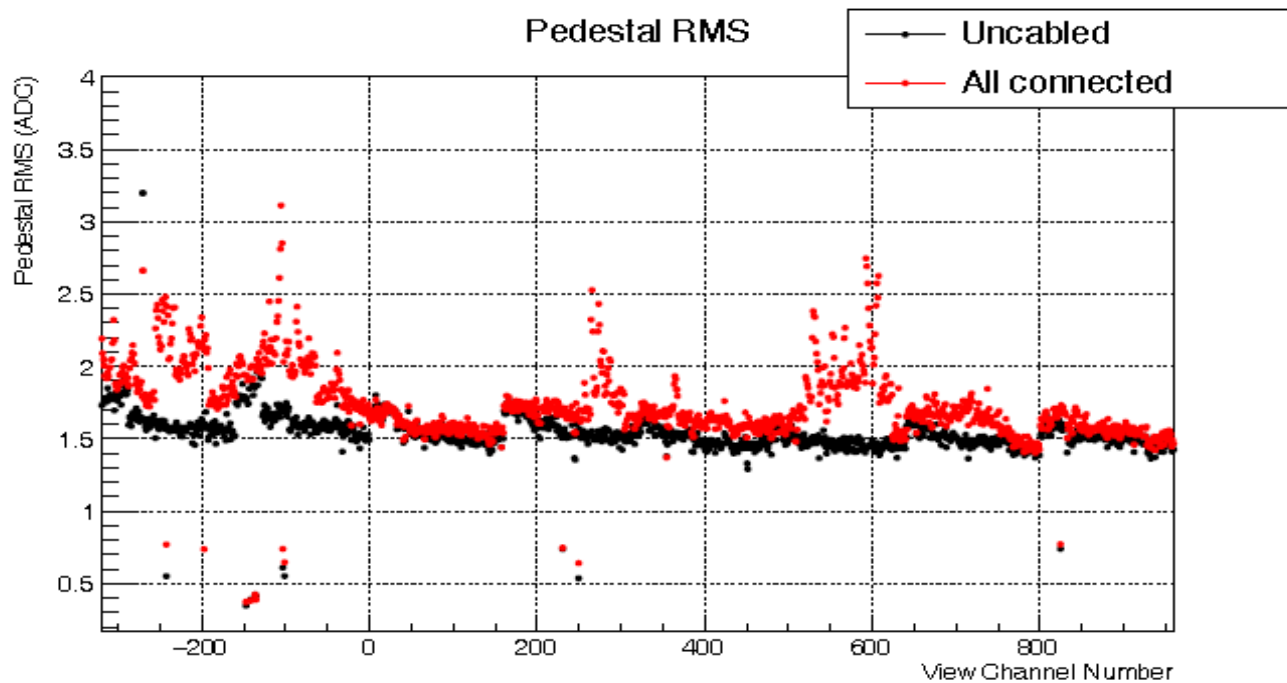

The grounding scheme for the 6x6x6 is more sophisticated with the cryostat, FE electronics and slow control completely insulated from external environment and only referred to cryostat ground.

Online processing and storage facility: internal bandwidth 20 GB/s, 1 PB storage, 384 cores: key element for online analysis (removal of cosmics, purity, gain, events filtering)

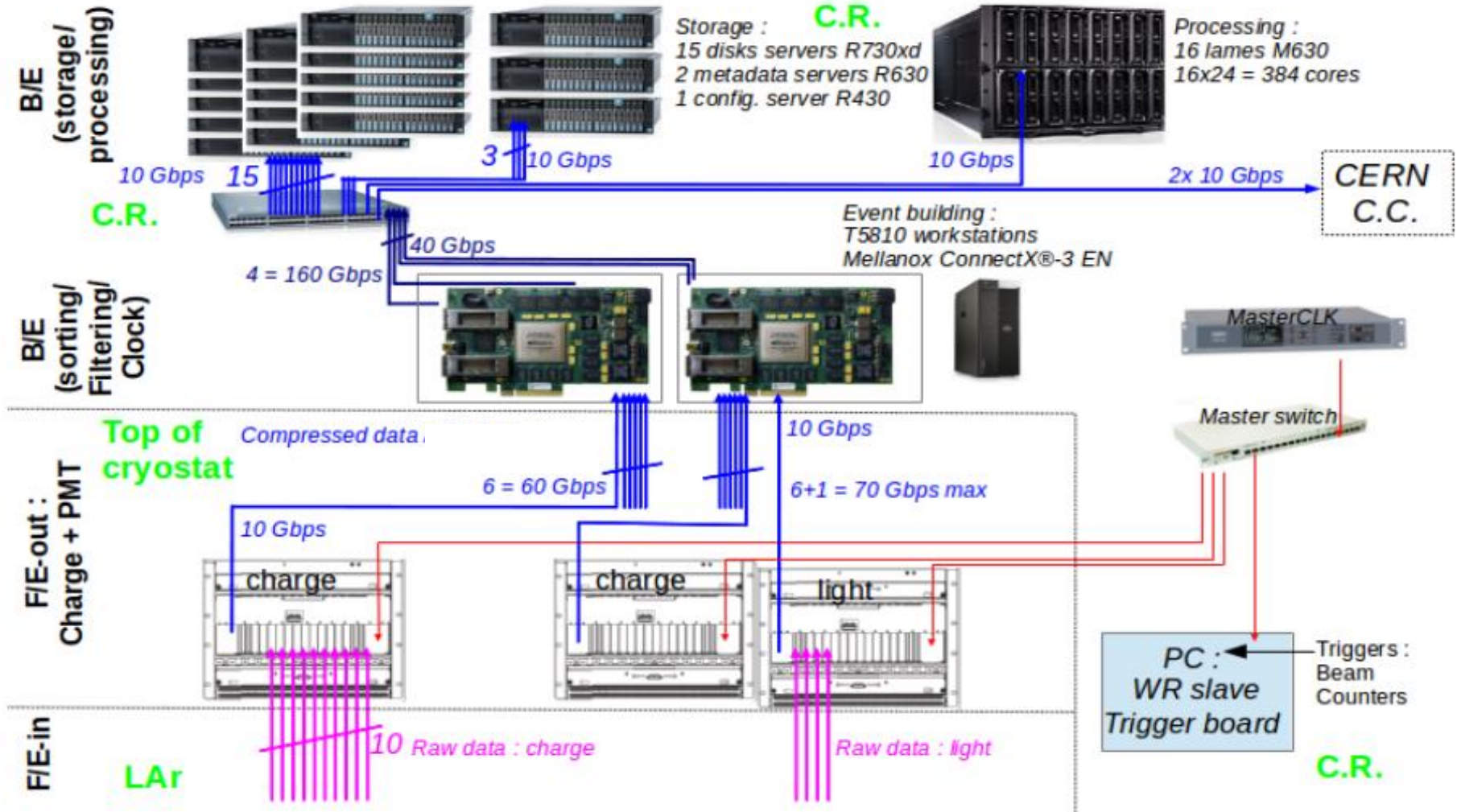

C.R. stands for Counting Room

- First design of online storage/processing DAQ back-end farm performed in 2016 (1PB, 300 cores, 20Gb/s data flow),

DELL-based solution : configuration

storage servers :

- * 15 R730XD (storage servers) including :
- * 16 disks 6To
- * 32Go RAM
- * 2 disks system RAID 1, 300 Go 10k
- * 1 network card Intel X540 double port 10 GB
- * 4 years extended guarantee (D+1 intervention)
- * 2 processors Intel Xeon E5-2609 v3
- * raid H730P
- * Rails with management arm
- * double power supply

metadata servers (MDS) :

- * 2 R630 (metadata servers), including :
- * 2 disks 200 Go SSD SAS Mix Use MLC 12Gb/s
- * 2 processors Intel Xeon E5-2630 v3
- * 32Go DDR4
- * RAID H730p
- * network : Intel X540 2 ports 10 Gb
- * 4 years extended guarantee (D+1 intervention)
- * Rails with management arm
- * double power supply

configuration server :

- * 1 R430 (configuration server)
- * 1 processor E5-2603 v3
- * RAID H730
- * 2 hard disks 500 Go Nearline SAS 6 Gbps 7,2k
- * 16 Go DDR4
- * Rails with management arm
- * double power supply

Offline computing farm: 16*24 = 384 cores

- * 1 blade center PowerEdge M1000e with 16 blades M630, each including :
- * 128Go DDR4
- * 2 processors Intel Xeon E5-2670 v3
- * 4 years extended guarantee (D+1 intervention)
- * 2 hard disks 500 Go SATA 7200 Tpm
- * network Intel X540 10 Gb

Switch Force10, S4820T (see next slide) :

- * 48 x 10GbaseT ports
- * 4 x 40G QSFP+ ports
- * 1 x AC PSU
- * 2 fans



- Smaller test scale system already installed and operative for 3x1x1

- Tests to finalize the architecture of final online storage/processing facility.

x24 40Gbits/s links

Further evolution of the network backbone architecture for 6x6x6 taking into account 40 Gbit/s connectivity

X 4 DAQ

x1 CERN IT
40 Gbit/s

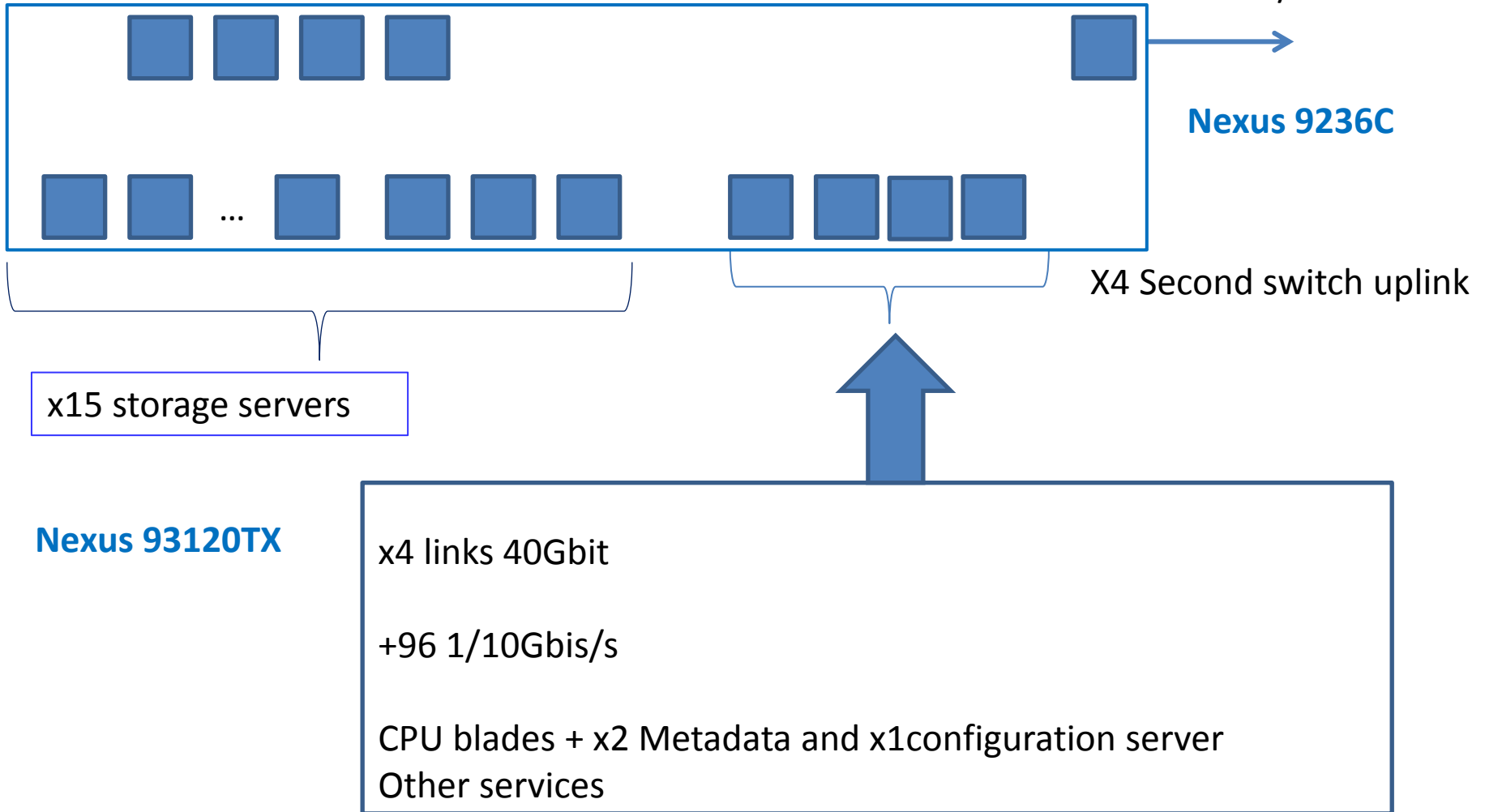

Online Processing:

- Extensive tests during the last year have show the validity of use a local EOS implementation as high performance distributed file system to build up a storage backend at the 20 GB/s level
- This is already implemented at the level of the 3x1x1 which provided also very good experience for all the software and system management developments)
- Procurement of computing material (disk servers, CPU and network architecture) for 6x6x6 online computing and storage facility already started in collaboration with the Neutrino Platform people
- Very strong collaboration and support from the IT division
- Very good infrastructure with counting rooms racks and cooling power (about 350 kW), final 40 Gbit/s connectivity to IT for each one of the protoDUNE detectors
- Other more critical components like the DAQ backend machines, metadata server etc, being finalized). All the backend hardware should be finalized for procurement in the next two months.

→ Looking forward to the start of the FE-DAQ installation in November 2017 !

Conclusions:

- The 3x1x1 pilot detector has been extremely useful in order to reach an advanced state of prototyping and costs assessment of most of the components for the 6x6x6 and to anticipate legal and procurement problems. The 3x1x1 assembly was completed in the fall 2016. The operation with liquid argon of the 3x1x1 has unfortunately not started yet due to delay in the cryogenic system and a recent problem with the cryostat.
- Experience gained so far with 3x1x1 construction, slow control operation, gas purge and purity measurements, FE electronics, noise and grounding, smooth operation of the DAQ system and online storage and processing commissioning has been conformal to expectations and very fruitful. The 3x1x1 activities have allowed retiring and/or reducing risks for PD-DP through (1) identification of potential critical components (2) early detection of potential problems. Most have been already taken into account in the 6x6x6 design.
- The executive design of the remaining aspects of the 6x6x6 CRPs, Field Cage, cathode, was completed by the end of November 2016. The schedule has been revised by taking into account final design and precise operation sequences, availability of infrastructure (clean room in 185 and cryostat + clean room buffer) , experience from 3x1x1 assembly, follow up of orders and tendering.
- Production and construction activities started. FE and DAQ electronics, Slow Control, PMTs, HV, Cosmic Ray Triggers were already in production phase. The beamline + instrumentation design was completed as well and installation started. A global picture of the progress during the last year is described in the CERN SPSC 2017 yearly report
- The DP ProtoDUNE construction is in an advanced state and largely benefited of the preparation activities/experience with the 3x1x1. We are looking forward to the completion of the DP ProtoDUNE detector assembly in the cryostat and the exploitation with the beamline in 2018 !

Detector installation in EHN1

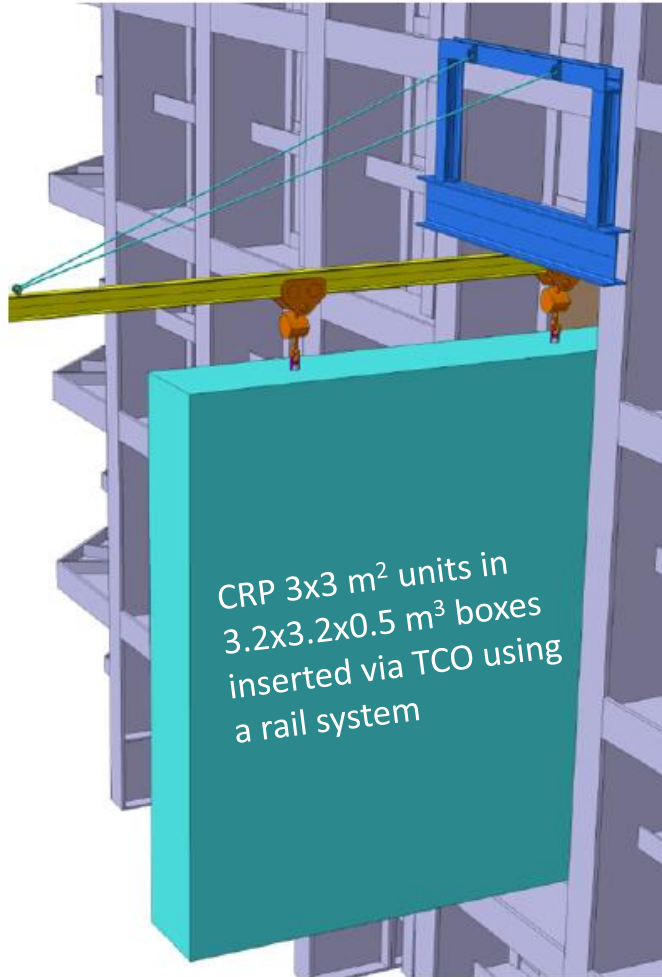

TCO = Temporary Construction Opening

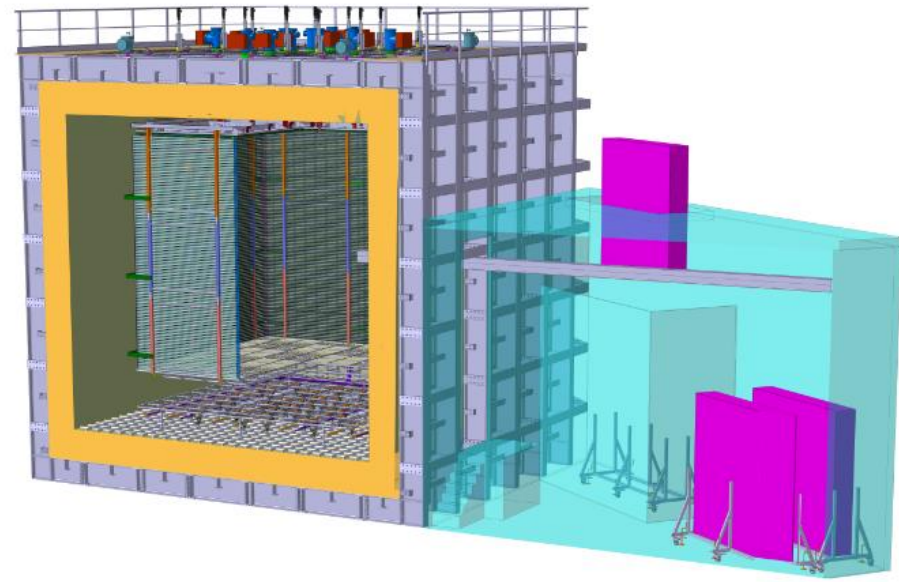

Clean room
hatch matched to TCO

- Feedthroughs are installed first
- The material for detector installation is brought to a clean room buffer and then via TCO into the cryostat
- CRPs will be pre-assembled at CERN, packed in a protective case, and then brought in vertically via TCO
- All elements (CRP+field cage panels + cathode sub-modules in basic units of similar standard sizes)
 - ➔ Installation sequence same as for 10kt DUNE
- **CRP assembly at CERN in clean room in Bld 185** (4 CRP assembly in parallel)