



ACCELERATORS

CINDY JOE

SATURDAY MORNING PHYSICS

OCTOBER 21, 2017

ABOUT ME

- Grew up in Arkansas
- Bachelor's degree in physics from Reed College in Portland, Oregon
- Nuclear reactor operator for 5 years

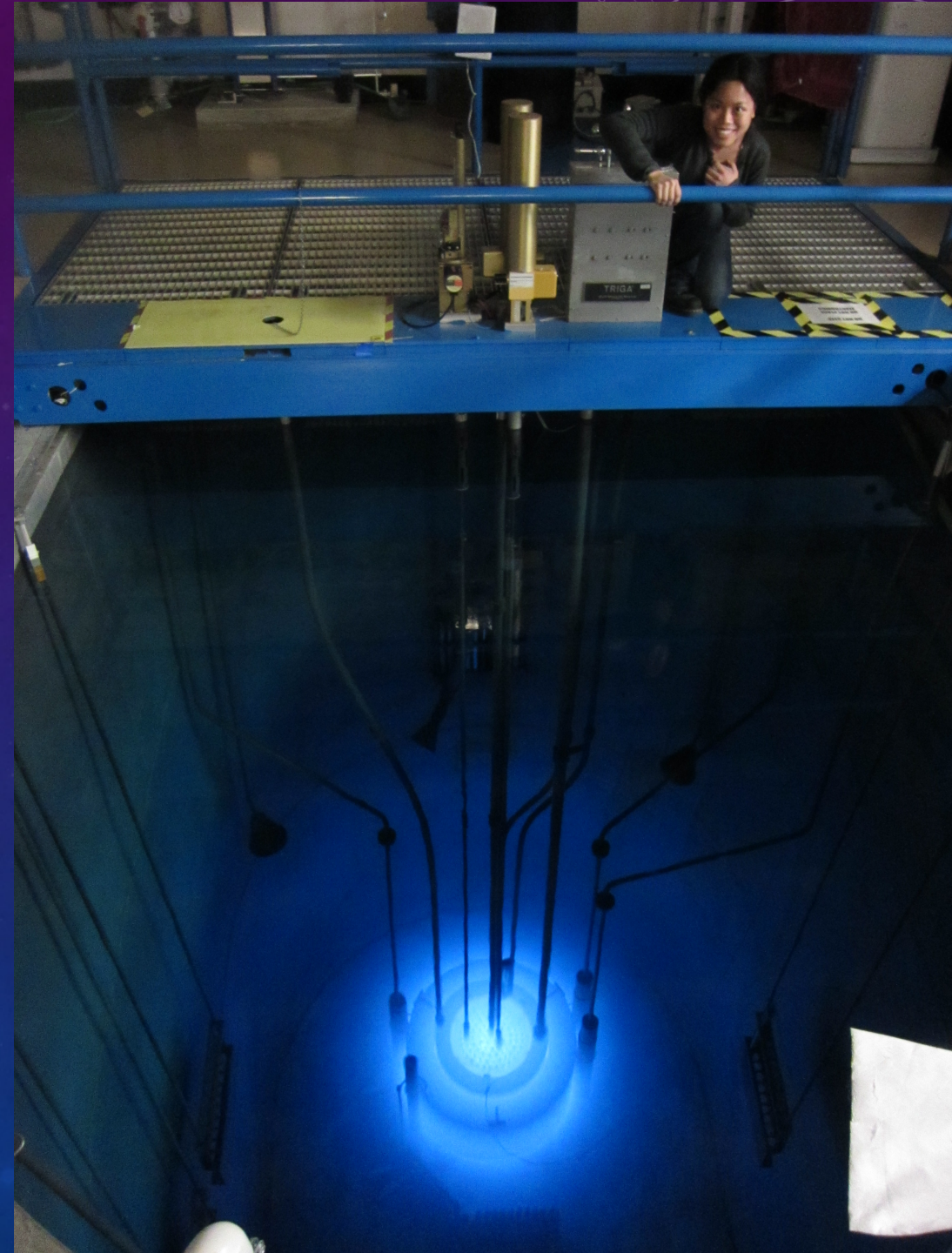
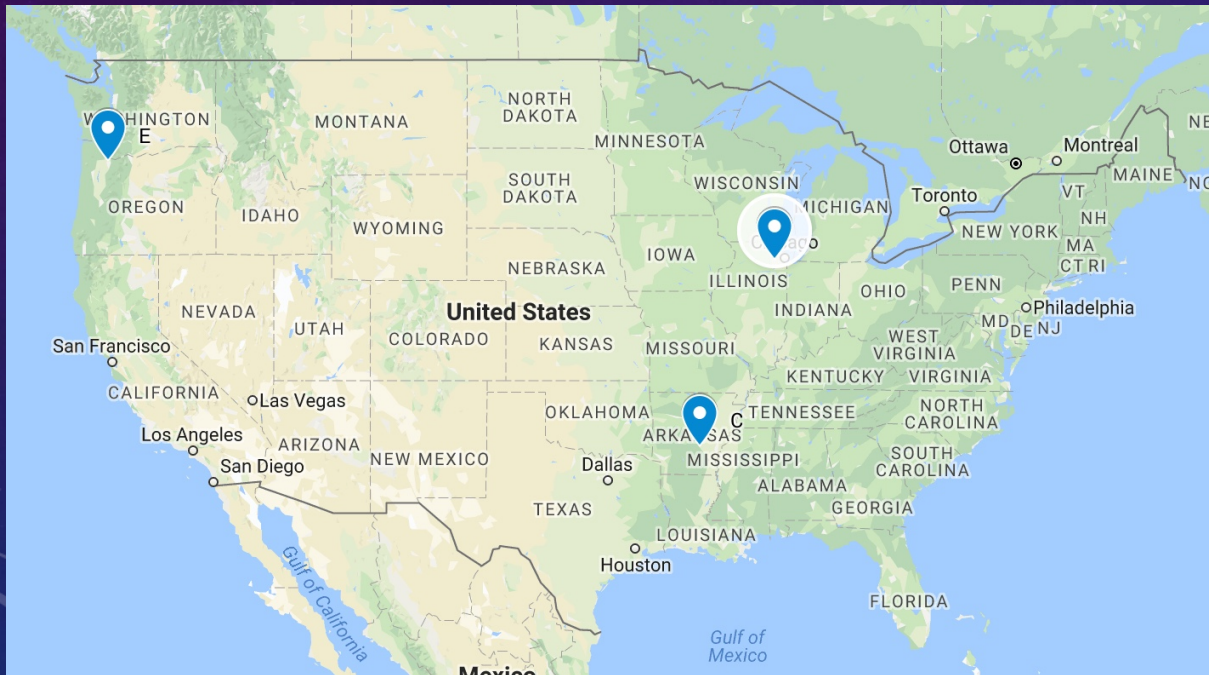

ABOUT ME

- Fermilab since 2010
- Most of that time: particle accelerator operator
- I like big science machines!
- Currently an engineering physicist: *I solve problems*
- Work with neutrino experiments and manage the NuMI Underground experimental areas at Fermilab



CAVEATS

- I have chosen to make this a more hardware-focused talk.
- However, if this is something that interests you, a more formal construction is necessary and encouraged.
- Some great resources for further study, in order of advancement:
 - Past SMP talks about Accelerators by Eric Prebys, Fernanda Garcia, Elvin Harms: inspiration and borrowed material
 - "Concepts Rookie Book," written by accelerator operators at Fermilab: borrowed many images
 - Online lectures and other material from the U.S. Particle Accelerator School

MOTIVATION



WHAT IS A PARTICLE ACCELERATOR?

- **PARTICLE:** subatomic particles (usually)
 - protons, electrons, but could be heavier cousins like ions
- **ACCELERATOR:** makes a particle go faster = gives it extra energy
- So a particle accelerator is a machine that we use to add energy to particles of matter

BEAM

- Sometimes you'll hear me refer to "beams" of particles—we are usually not accelerating one particle, but a whole collection of them
- A collection of tiny, fast-moving particles all going in the same direction does behave a lot like a beam of light, and can be bent and focused the way a prism or lens would bend or focus light, but using magnets (more about that later)

WHY DO WE ACCELERATE PARTICLES?

$$E = mc^2$$

Derived using only math (mostly algebra) and the two conjectures:

1. The laws of nature are the same in all inertial frames of reference.
2. The speed of light in the vacuum is the same in all inertial frames of reference.

Mind: Blown!
Wonderful Theoretical Fun!

Energy and mass are the same thing

Skip the implications of $E=mc^2$

How do we know
Special Relativity
is accurate?

*In depth:
 E , momentum and mass*

Full equation for total energy

$$E = \sqrt{p^2 c^2 + m_0^2 c^4}$$

- In other words ...
- anything with energy has momentum.
- A photon has momentum

- Remember Elliott talking about this a few weeks ago?
- We are giving particles extra energy, and later we can turn that extra energy into mass = NEW PARTICLES!

WHAT DO WE DO WHEN WE ACCELERATE PARTICLES?

- The main things we do with accelerated beams of particles:
 - Smash them into a fixed target (“fixed target”)
 - Smash them into each other (“colliding beams”)
 - Allow them to radiate energy (“synchrotron light source”)

WHY DO WE ACCELERATE PARTICLES?

- These have myriad uses:
 - Particle physics
 - Nuclear physics
 - Altering the structure of matter for the purposes of medicine or industry
- I will concentrate on what we do here at Fermilab: high energy particle physics

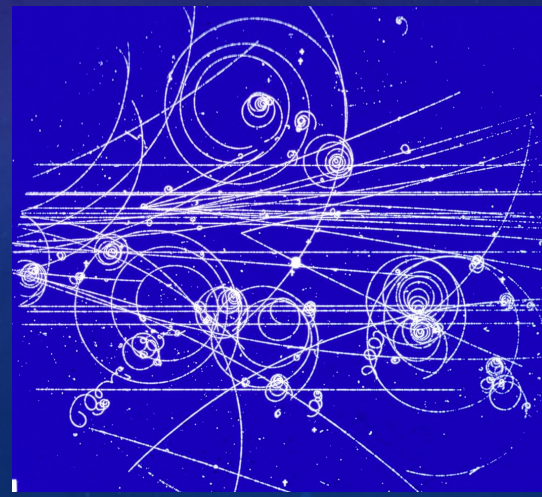
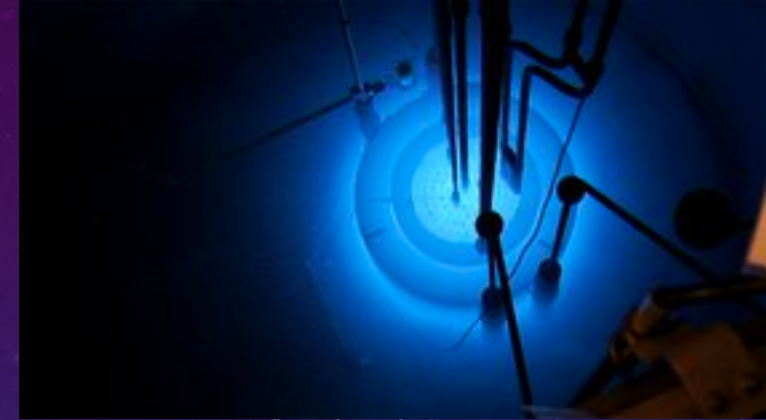

PARTICLE ACCELERATORS ARE OUR EYES

- Particle accelerators (and detectors) are the tools of high energy physics
 - Like microscopes or telescopes, they allow us to see things we wouldn't be able to with the naked eye
 - In this case, things about the fundamental building blocks of the universe, of matter and energy and the forces that govern how they interact
- Higher energies, smaller wavelengths, information about smaller things

Accelerators: the ultimate microscope

- All particles have wave properties
- We need to use particles with **short wavelengths** to get detailed information about **small things**
- A particle's momentum and its wavelength are inversely related

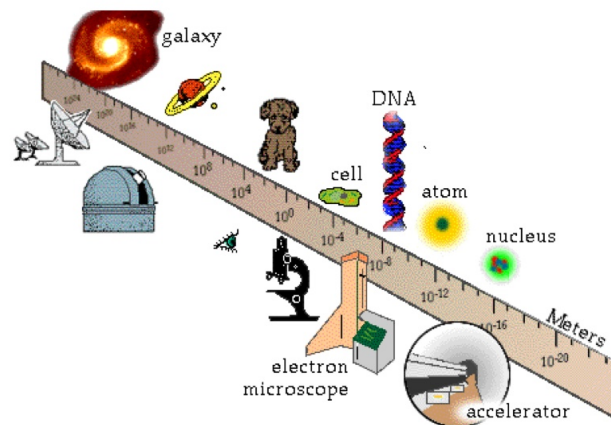
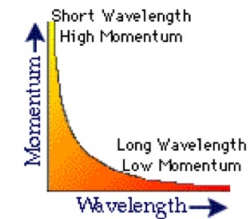

We use particle accelerators to increase the momentum of the probing particle, thus decreasing its wavelength

ACCELERATORS LET US GO BACK IN TIME (!)

- It took many millions of years for matter as we know it to be formed (as we know it)
- Accelerators let us re-create conditions like those a few *trillionths* of a second right after the Big Bang, 13.8 billion years ago
- This can give us more information about the formation of the universe, the structure of matter, where the universe might be headed

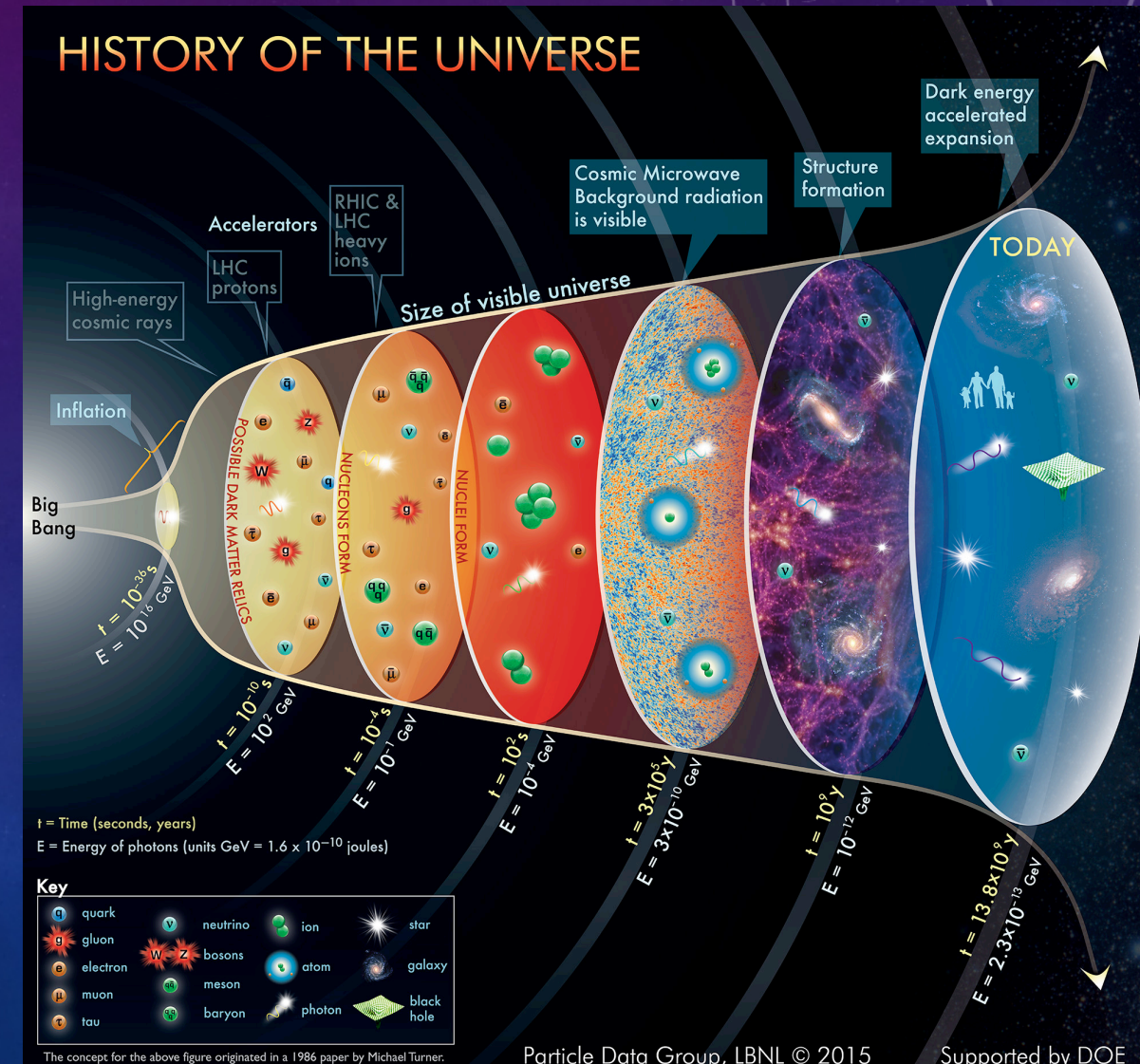

I HOPE YOU'RE CONVINCED...

- Accelerators are very useful, and pretty great!
- Questions before we move ahead?

LET'S BUILD A PARTICLE ACCELERATOR

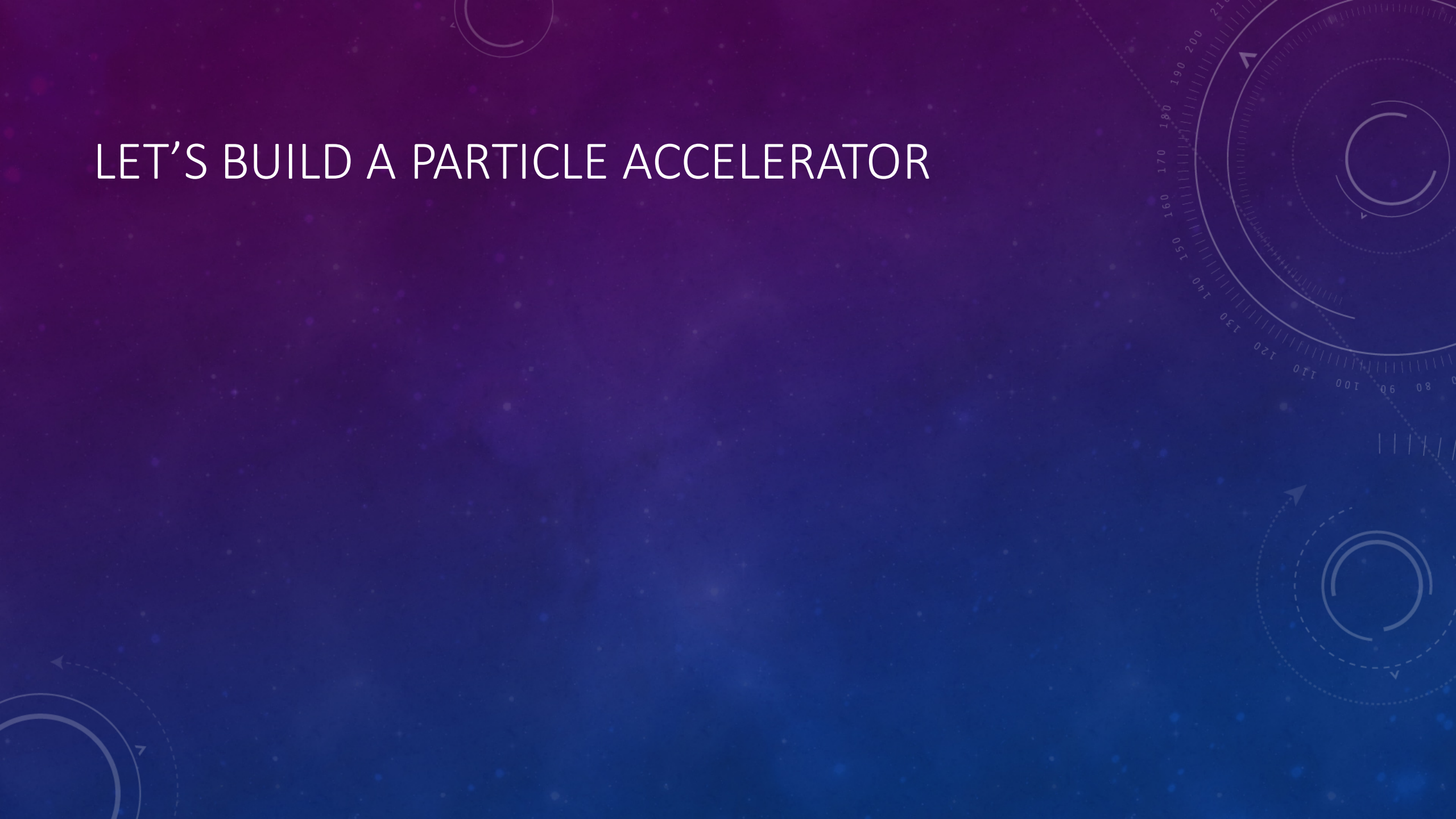

THE CINDYTRON

The background features a gradient from dark purple to blue, overlaid with a field of small white stars. Several technical diagrams are visible: a circular gauge with a scale from 0 to 210 and an arrow pointing to approximately 190; a circular diagram with concentric lines and arrows; and a circular diagram with dashed lines and arrows.

THE CINDYTRON



SO HOW DO WE ACCELERATE PARTICLES?

What is the World Made of? What Holds it Together?

Standard Model (~1970)

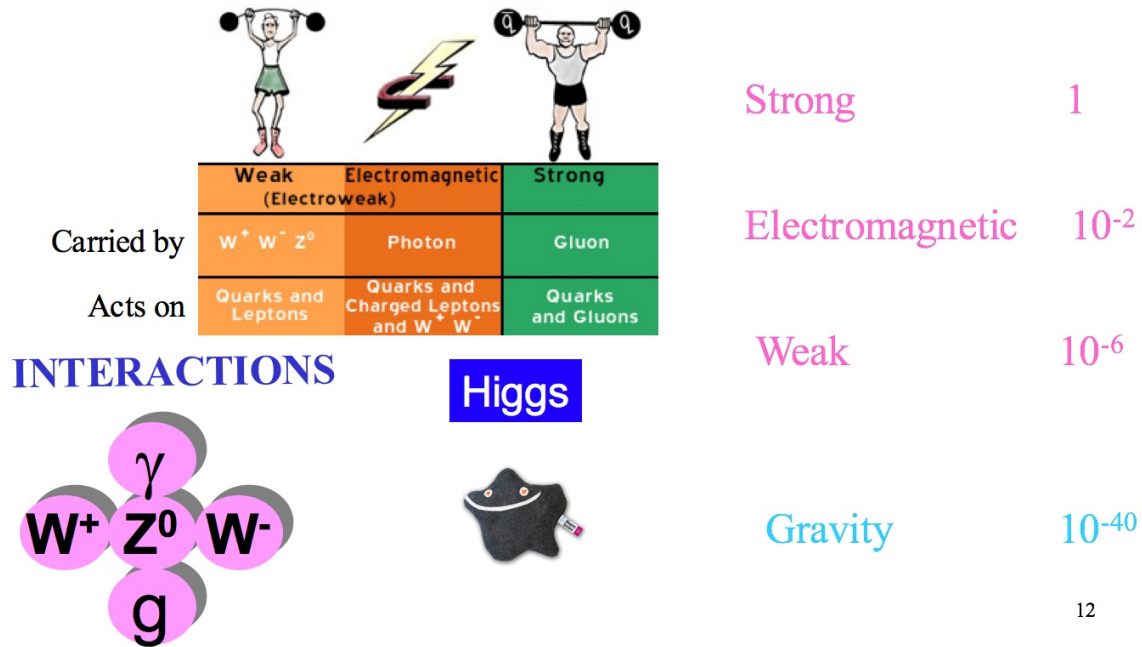

NEWTON'S SECOND LAW, AND WORK

- $\vec{F} = m \vec{a}$
 - Force is equivalent to mass times acceleration
 - Not just velocity (moving at constant speed) but acceleration (changing speed or direction)
 - (remember special relativity from Elliott's lecture?)
 - Larger mass or greater acceleration = more force
- $W = F d = F \Delta x$
 - "Work" is the result of a force applied over a distance (a.k.a. a change in its position, x , represented by "delta")
 - A massive object is moved: work has been performed to get it there
 - Work takes energy: chemical, mechanical, nuclear, etc.

ENERGY IS CONSERVED

- Potential energy \leftrightarrow Kinetic energy
- An object held at a height possesses gravitational potential
- When dropped, gravity does work on the object as it falls, accelerating it and turning that gravitational potential energy (energy stored at rest) into kinetic energy (energy of motion)
- If you pick it up again and hold it at a height, the work you have done on the object gets turned back into potential energy

SO COULD WE USE GRAVITY?

What is the World Made of? What Holds it Together?

Standard Model (~1970)

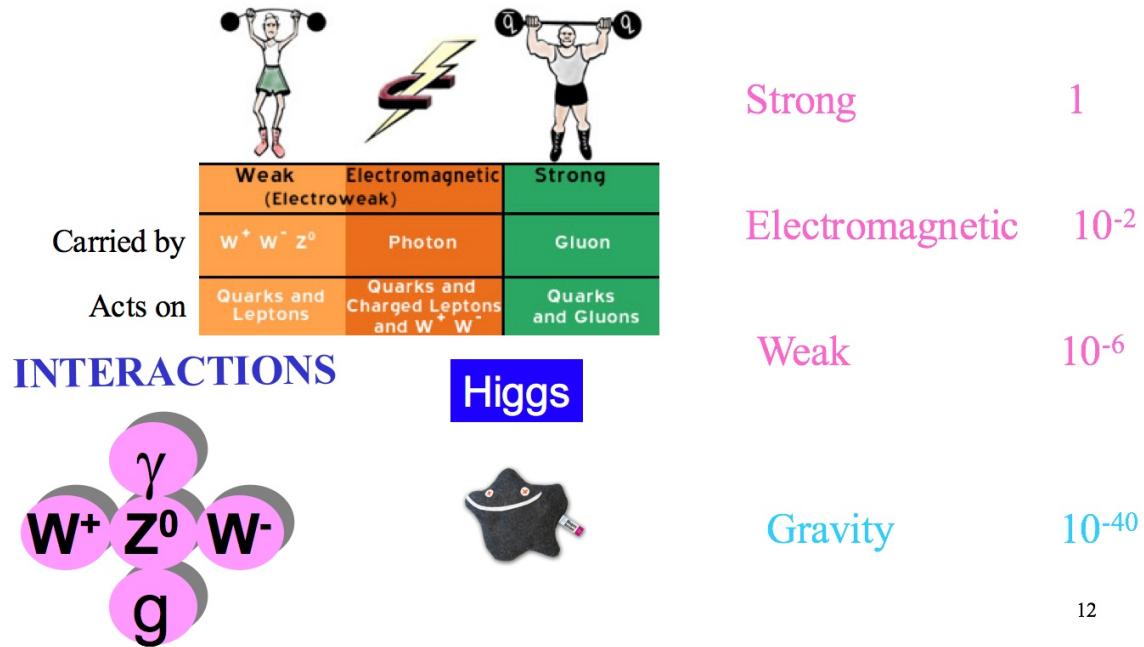

From Cecelia's talk last week



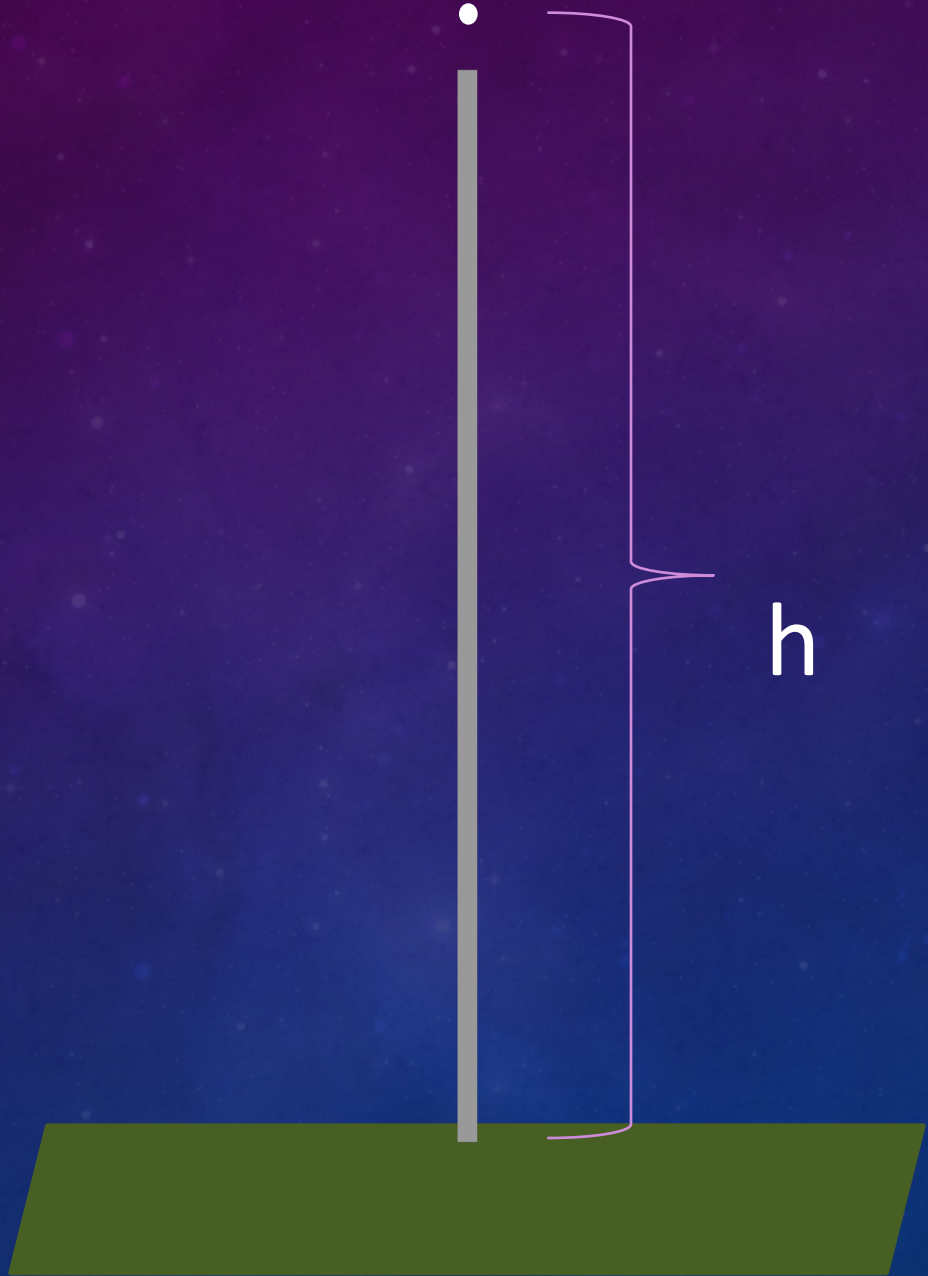

A GRAVITY ACCELERATOR?

- Here at Fermilab, our RIL (RFQ Injection Linac), the very start of our Proton Source, accelerates H⁻ ions to 750 KeV of energy.
- What height would you have to drop an H⁻ ion (one proton, two electrons) from for gravity to accelerate it to 750 KeV?

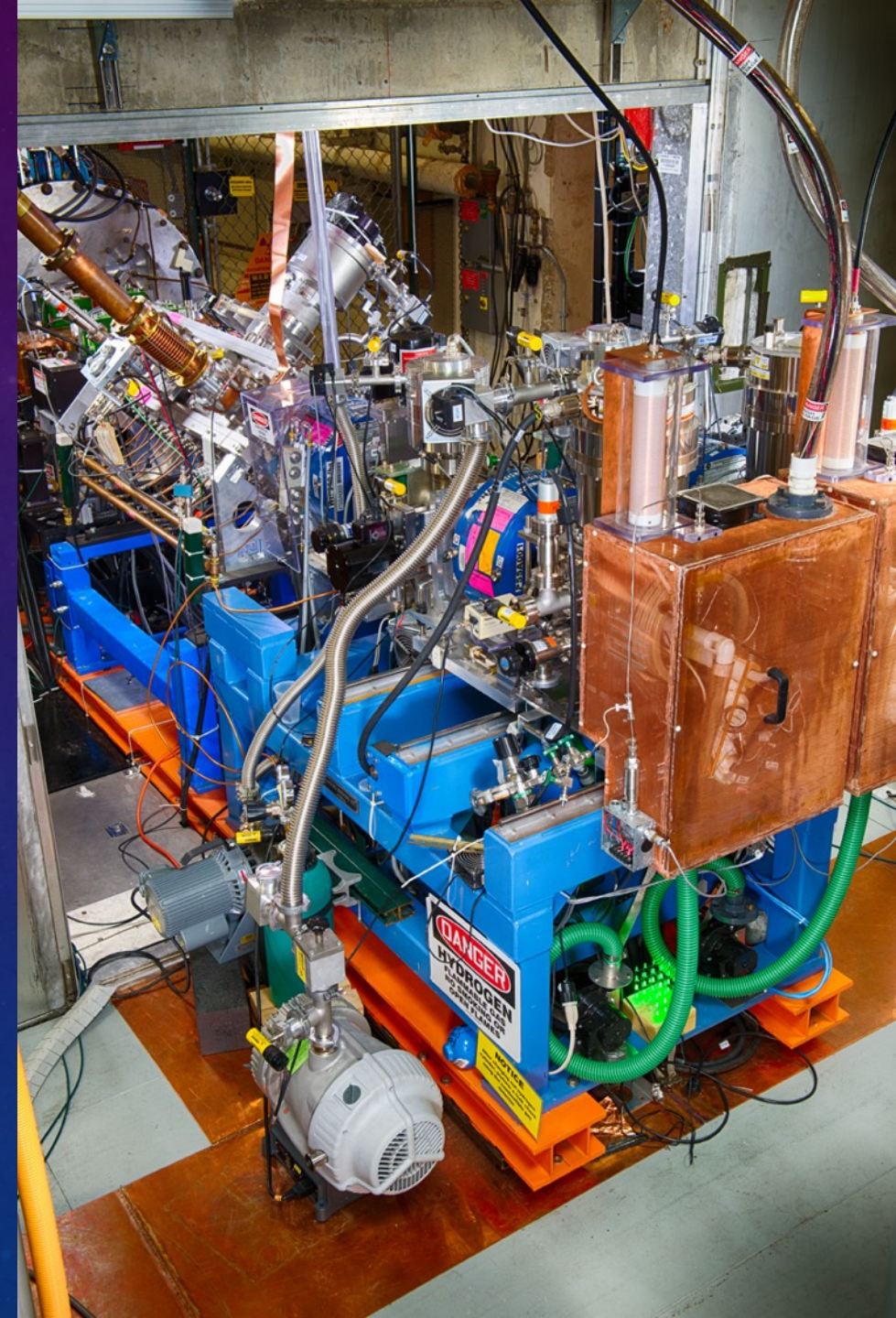

What height would you have to drop an H⁻ ion (one proton, two electrons) from for gravity to accelerate it to 750 KeV?

$$W = F d = F \Delta x$$



What height would you have to drop an H⁻ ion (one proton, two electrons) from for gravity to accelerate it to 750 KeV?

$$W = F d = F \Delta x$$

Set:

$$W = 750 \text{ KeV,}$$

$$F = m a = m g$$

$$\Delta x = h$$

g = acceleration due
to Earth's gravity

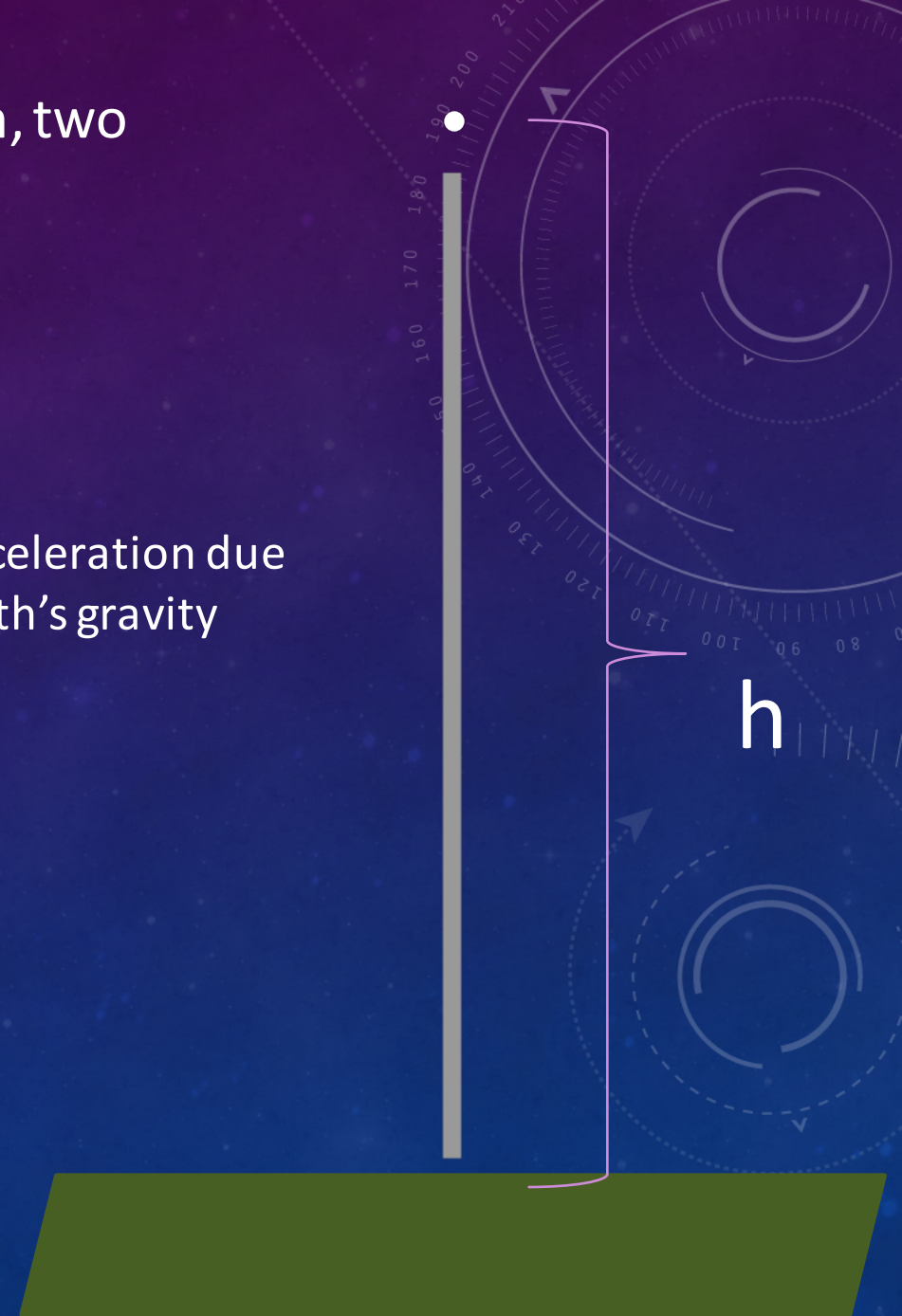

What height would you have to drop an H⁻ ion (one proton, two electrons) from for gravity to accelerate it to 750 KeV?

$$W = F d = F \Delta x$$

Set:

$$W = 750 \text{ KeV},$$

$$F = m a = m g$$

$$\Delta x = h$$

$$750 \text{ KeV} = m g h$$

g = acceleration due to Earth's gravity

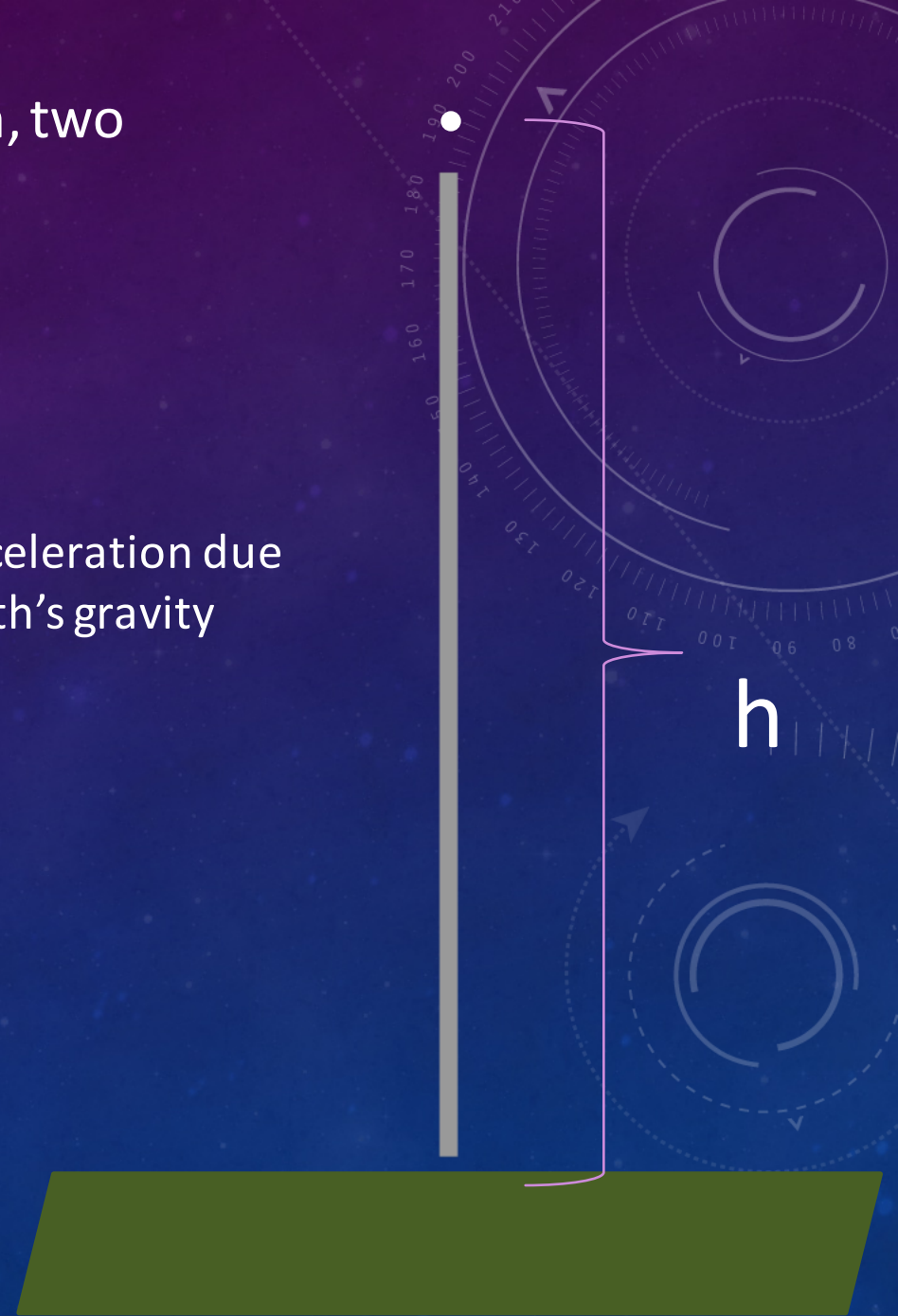

What height would you have to drop an H⁻ ion (one proton, two electrons) from for gravity to accelerate it to 750 KeV?

$$W = F d = F \Delta x$$

Set:

$$W = 750 \text{ KeV},$$

$$F = m a = m g$$

$$\Delta x = h$$

g = acceleration due to Earth's gravity

$$750 \text{ KeV} = m g h$$

Solve for h .

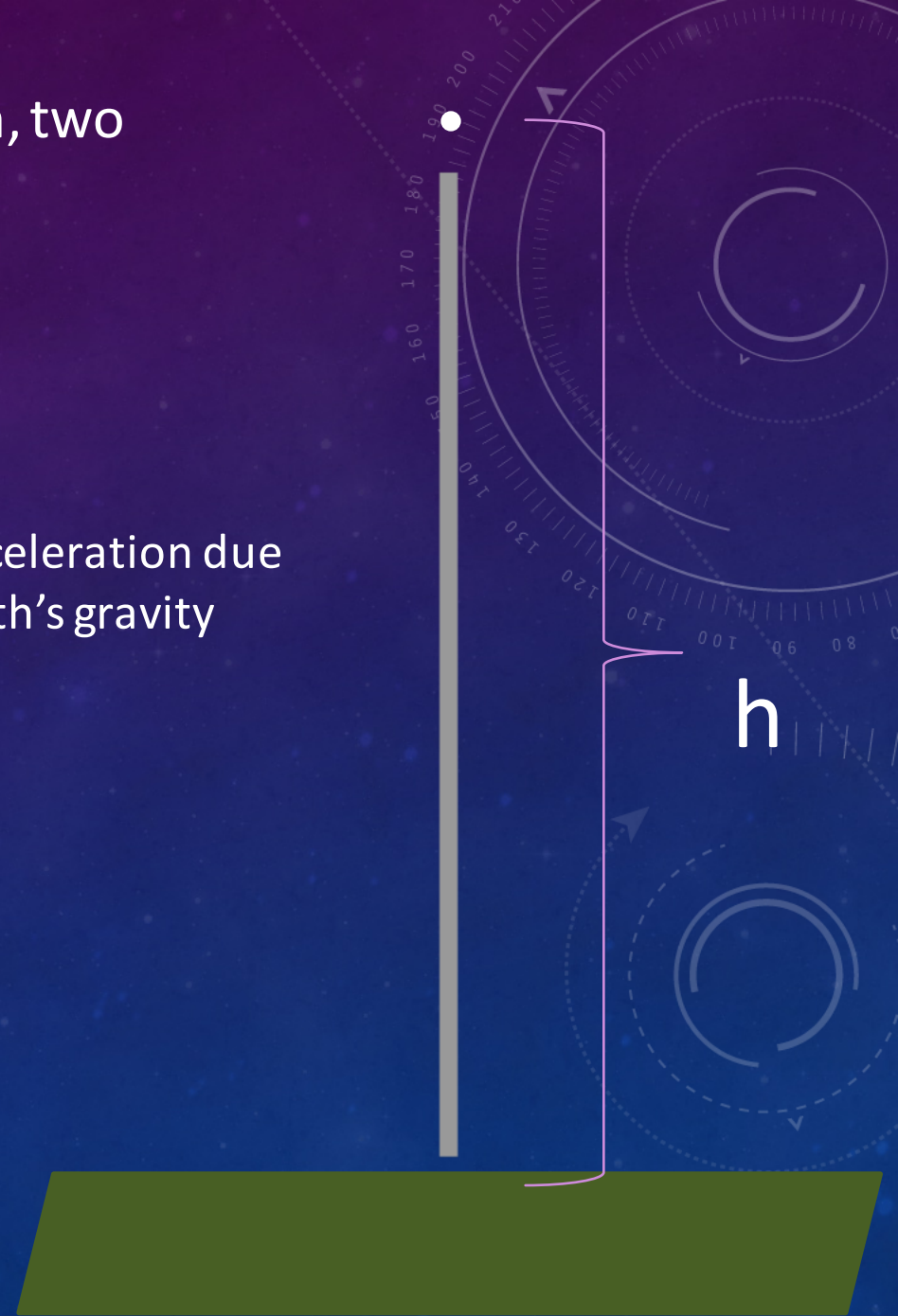

$$W = F d = F \Delta x$$

$$750 \text{ KeV} = m g h$$

Let's make some substitutions.

$$W = F d = F \Delta x$$

$$750 \text{ KeV} = m g h$$

Let's make some substitutions.

$$1 \text{ eV} = 1.602 \times 10^{-19} \text{ J, so}$$

$$750 \text{ KeV} = 1.204 \times 10^{-13} \text{ J}$$

For a H⁻ ion, 1 proton + 2 electrons

$$m = 1.672 \times 10^{-27} \text{ kg} + 2 (9.11 \times 10^{-31} \text{ kg})$$
$$= 1.6738 \times 10^{-27} \text{ kg}$$

$$g = 9.8 \text{ m/s}^2 \text{ (near the Earth's surface)}$$

Plugging it all in...

$$W = Fd = F \Delta x$$

$$750 \text{ KeV} = m g h$$

$$1.204 \times 10^{-13} \text{ J} = 1.6738 \times 10^{-27} \text{ kg} * 9.8 \text{ m/s}^2 * h$$

$$W = Fd = F \Delta x$$

$$750 \text{ KeV} = m g h$$

$$1.204 \times 10^{-13} \text{ J} = 1.6738 \times 10^{-27} \text{ kg} * 9.8 \text{ m/s}^2 * h$$

And solving for h gives us:

$$h \approx 7.34 \times 10^{12} \text{ cm}$$

SO WHAT DOES THAT MEAN?

- We would have to drop an H⁻ ion from ~73 million km to yield a 750 KeV kinetic energy
- (assuming a constant value for g, which is not accurate, but we're just performing what physicists would call a "back of the envelope" calculation)
- Earth is only 12,742 km in diameter (on average)
- That's almost 5.75 million times the diameter of the earth

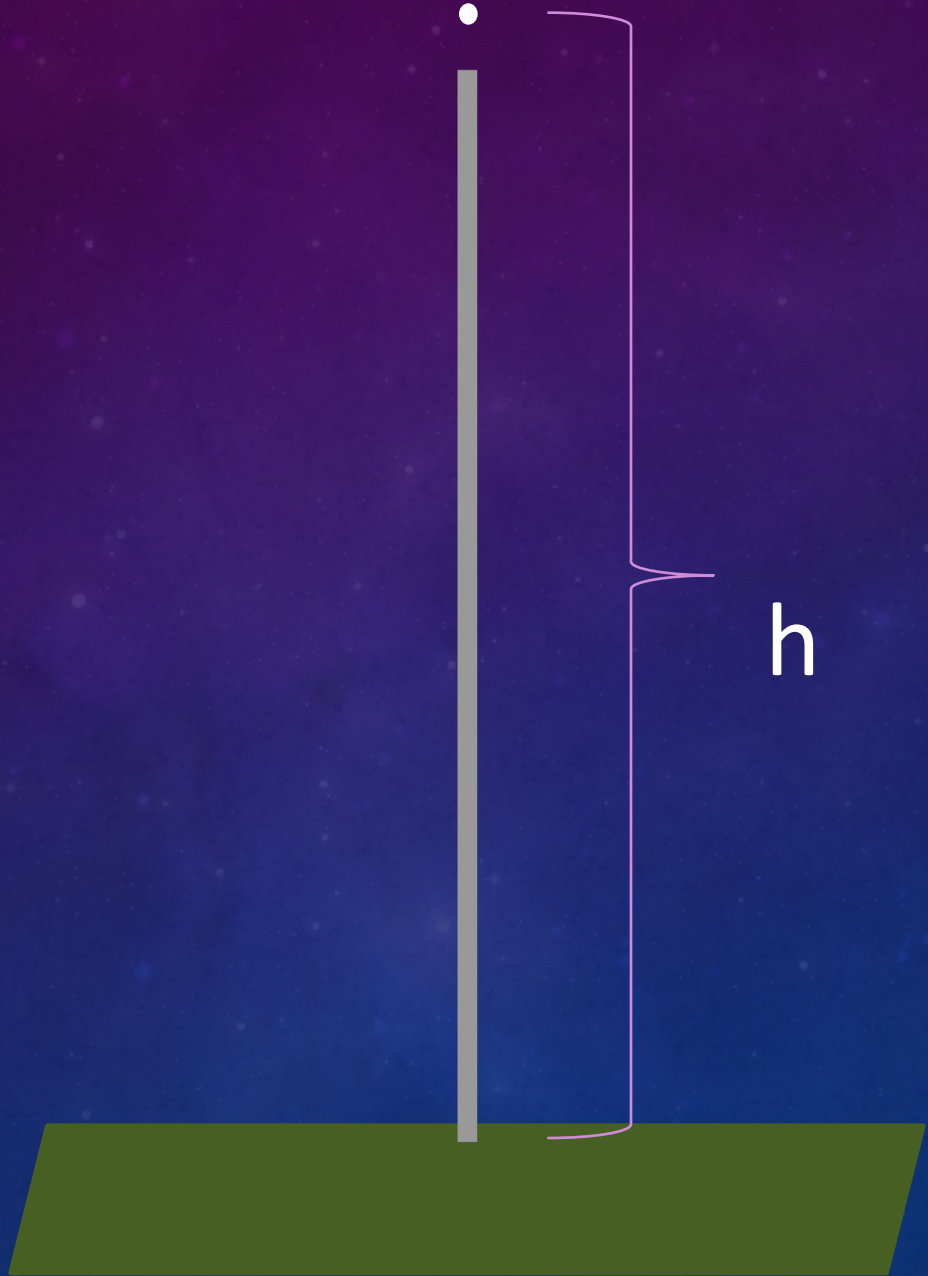

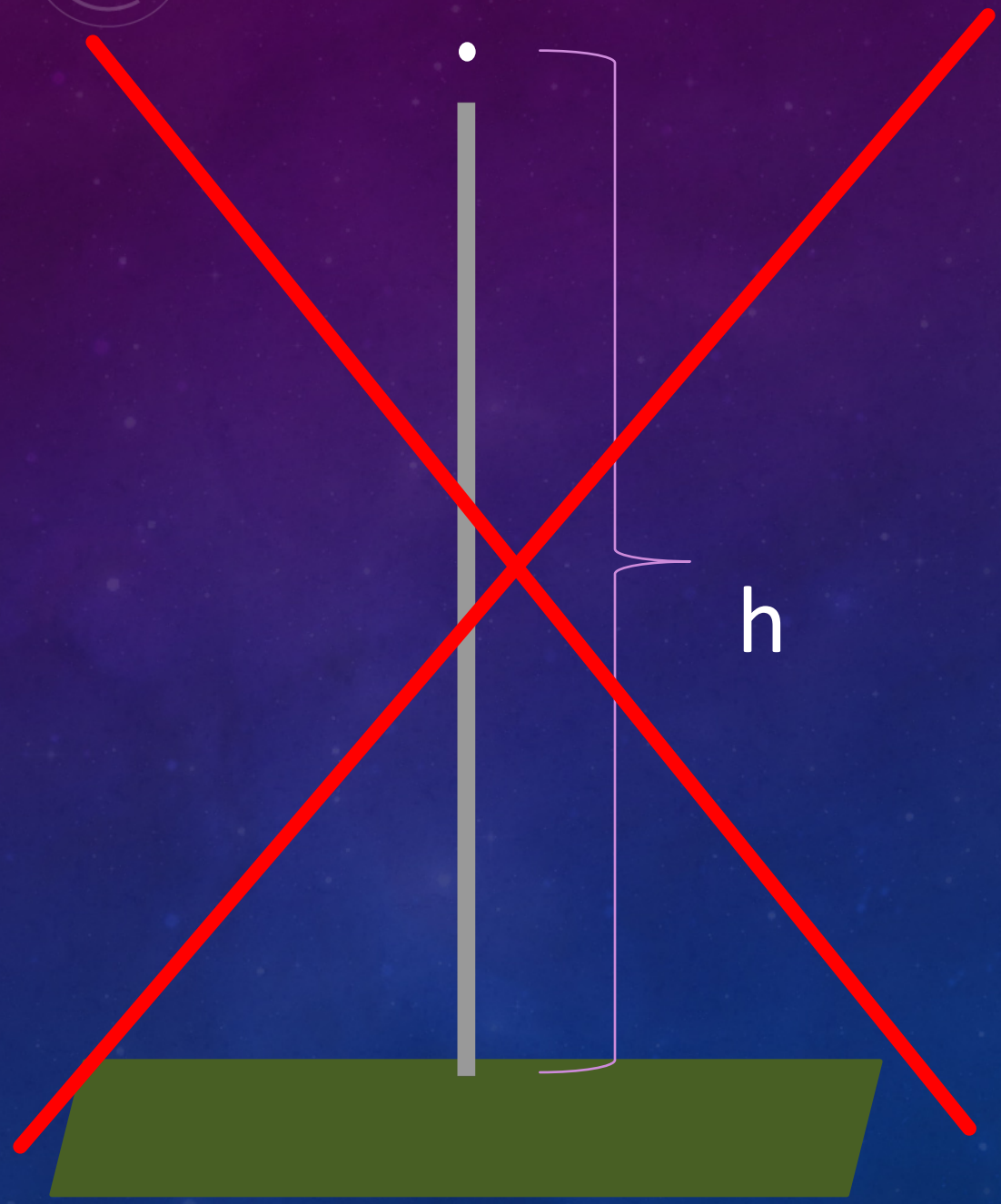

h

QUESTIONS?

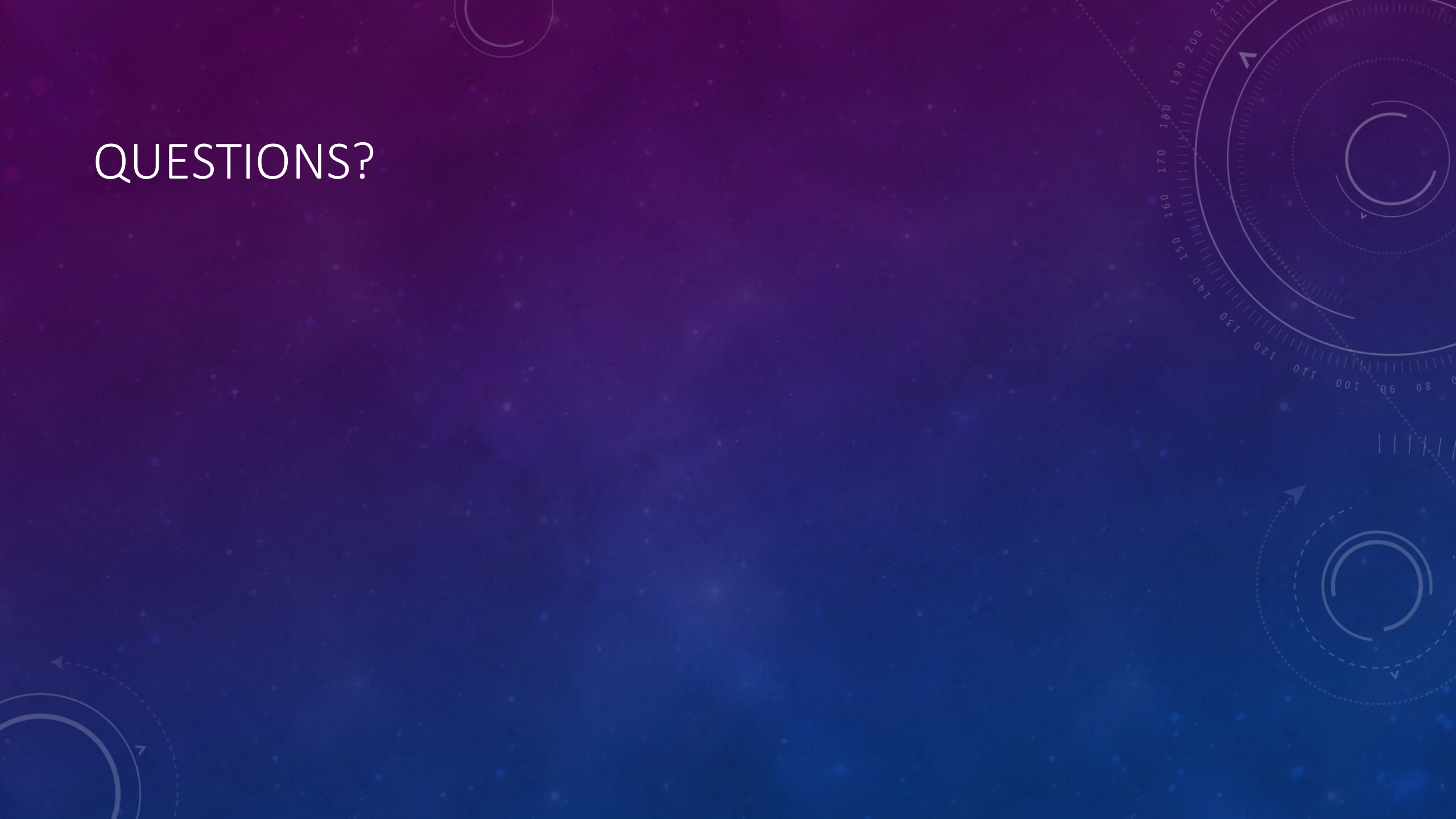

WHAT ABOUT THE ELECTROMAGNETIC FORCE?

What is the World Made of?
What Holds it Together?

Standard Model (~1970)

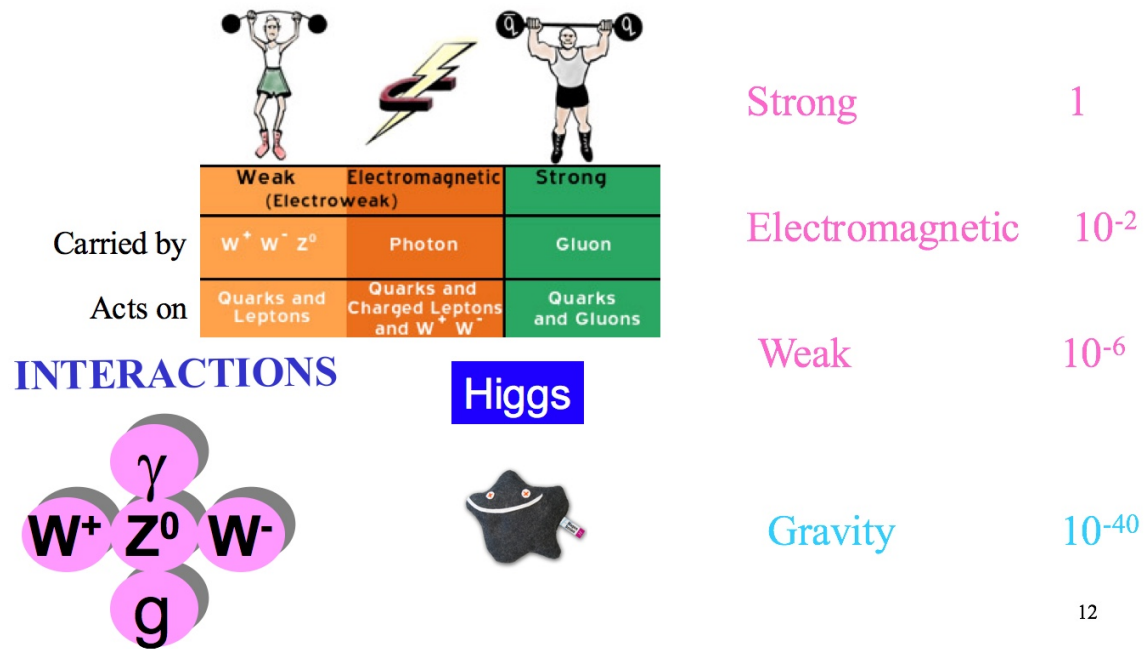

MORE BACKGROUND



FIELDS

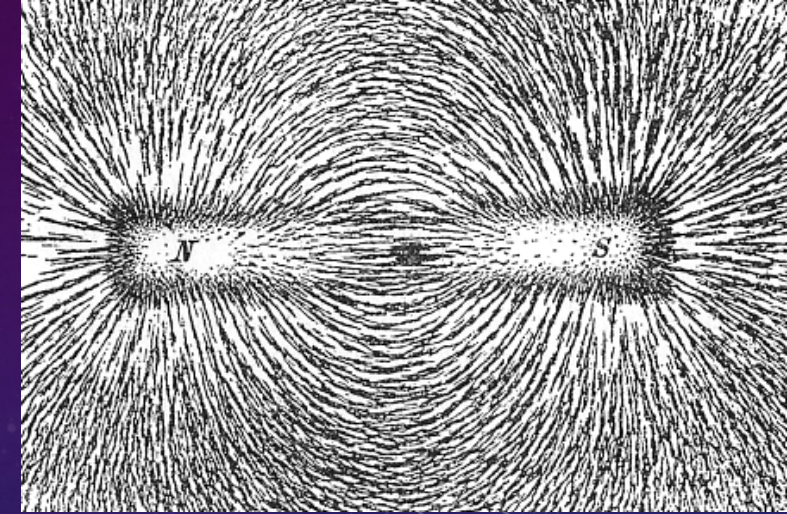

- Fields are weird. They just are.
- A way to explain the ability of an object to affect another object without directly interacting with it
- Examples: electric fields, magnetic fields, gravitational fields (general relativity)
- A field has a value at every point in space and time (fields are everywhere and always)
- One way of thinking about their effect: a source sets up a field in space, and objects respond to the field present at their locations (possibly experiencing a force)

ELECTRIC CHARGES, FIELDS, AND FORCES

- A charged particle creates an electric field. Another charged particle interacts with this electric field and experiences a force.
- Like charges repel, opposite charges attract

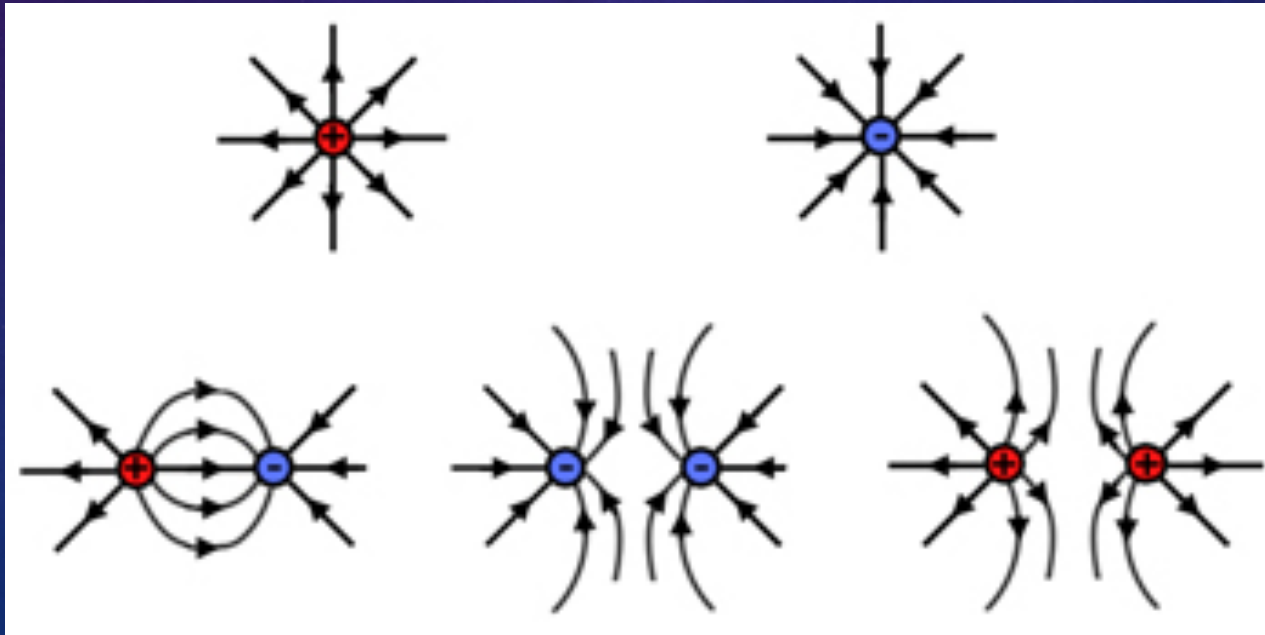

ELECTRIC CHARGES, FIELDS, AND FORCES

- $\vec{F} = q \vec{E}$
 - q = magnitude of the charge, usually given in units like Coulombs
 - E = Electric field, usually given in units like Newtons (a unit of force) / Coulomb, or Volts / meter
 - Force is proportional to the magnitude of the charge and the strength of the field (larger charge or larger field = more force)
- If a particle experiences a force over a distance, we can say that work was done
 - Either it experienced a gain in potential energy, or it got accelerated and experienced a gain in kinetic energy
- I'll get into magnetic fields and forces later

EV

- Remember that an object held at a height possesses gravitational potential
- When dropped, gravity does work on the object as it falls, accelerating it:
 - Potential energy (rest) \rightarrow kinetic energy (motion)
- When a charged particle is exposed to an electric field, the electrical field can do work on the particle, accelerating it and changing electrical potential into kinetic energy
- eV = the amount of energy gained by accelerating one electron of charge over 1 Volt of electrical potential
- This is a very, VERY small, but convenient unit of energy for us to use
 - KeV (10^3), MeV (10^6), GeV (10^9), TeV (10^{12})

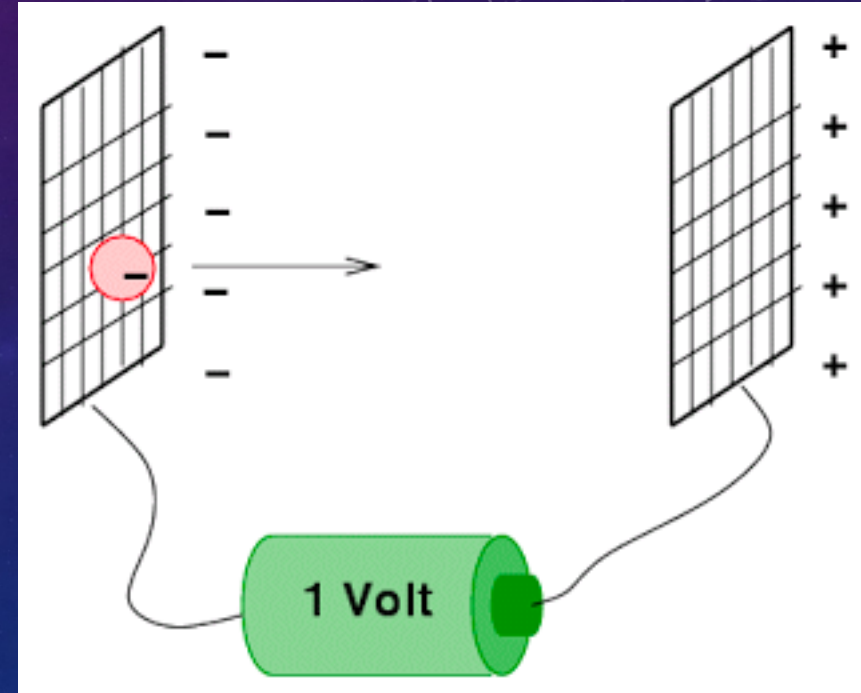

SO IF WE SET UP AN ELECTRICAL POTENTIAL...

- Would that accelerate a particle?
- Yes, and some “Electrostatic” accelerators work just like that.
- Examples: Crooke’s tube, Van de Graaf generator, Cockcroft-Walton



CROOKE'S TUBE (CATHODE RAY TUBE): 1870

- Voltage differential created across a cathode-anode pair
- Negatively charged electrons are attracted to the anode
- If allowed to strike a phosphor screen, glow is produced
- Charged plates can be used to precisely direct the electron spray to produce an image
- This technology is used in CRT screens (big, glass, non-flatscreen TVs and monitors)

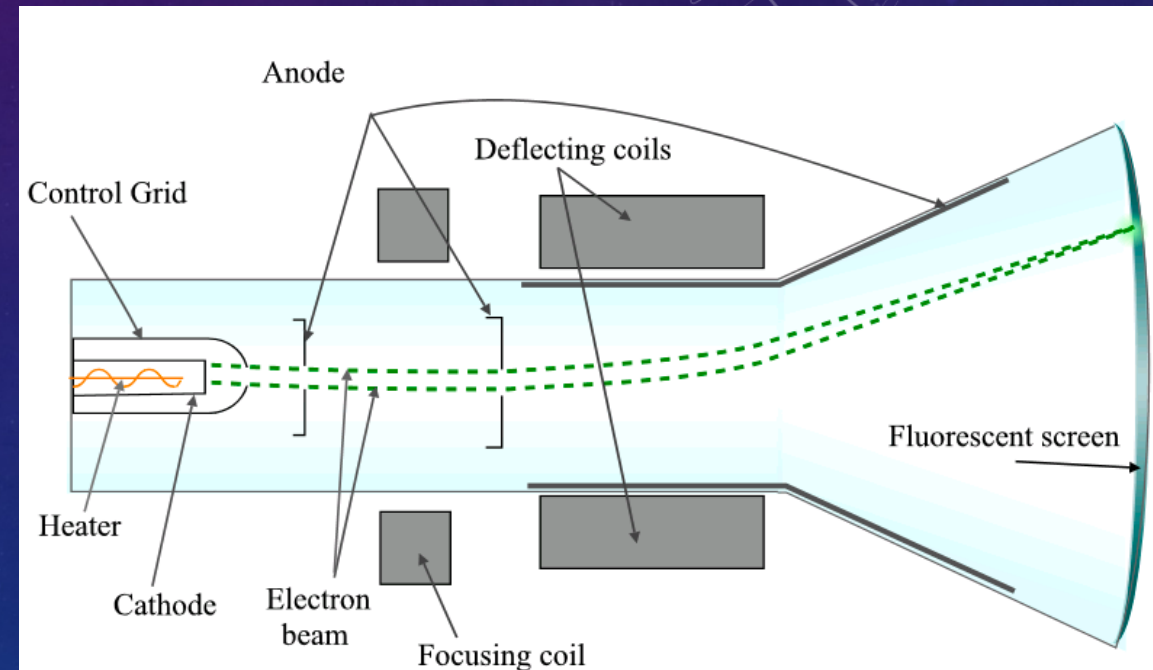

COCKCROFT-WALTON: 1928-1930

- Cleverly-designed stack of capacitors and switching diodes allows very high voltage differentials to be produced
- Voltages can be used to accelerate charged particles
- Similar idea as the Van de Graaf generator (invented later)—charge is built up
- It does have limitations: at some point you can't hold that high level of charge anymore—the breakdown voltage of the ceramic resistors and/or air is reached, and the charge bleeds off through sparking
- Used as the first accelerating structure in Fermilab's accelerator chain from 1968 to 2012: accelerated hydrogen ions (H-) to 750 keV

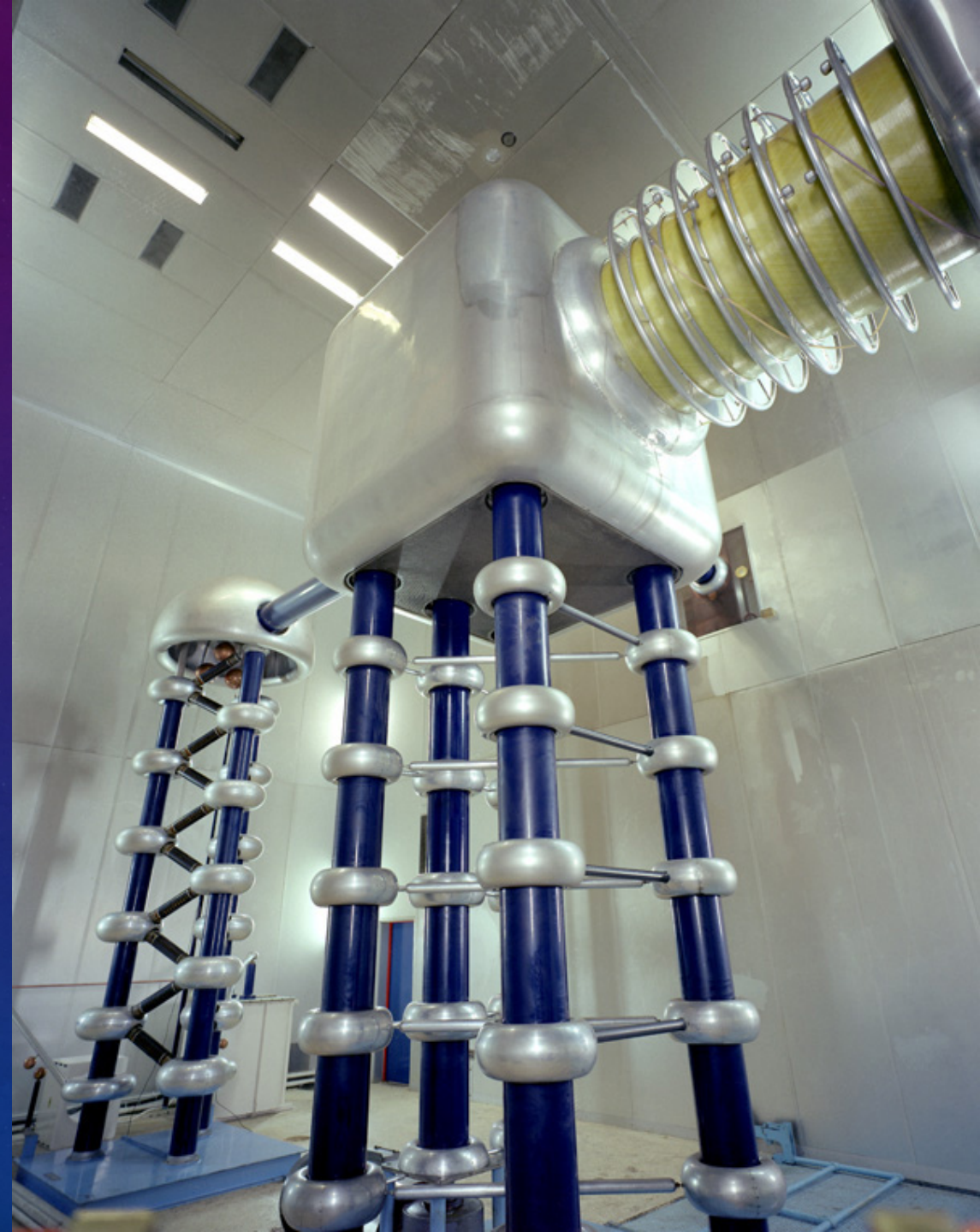

ELECTROSTATIC → ELECTRODYNAMIC

- But there's a certain point where the ability of air to hold an electrical voltage of that magnitude breaks down. We need to come up with another way.
- What about lots of small, lower-voltage pushes instead of one mighty super-high-voltage push?
- We can do that. That's what we use RF cavities for. RF = radio frequency, the band of the energy used.

Electromagnetic spectrum

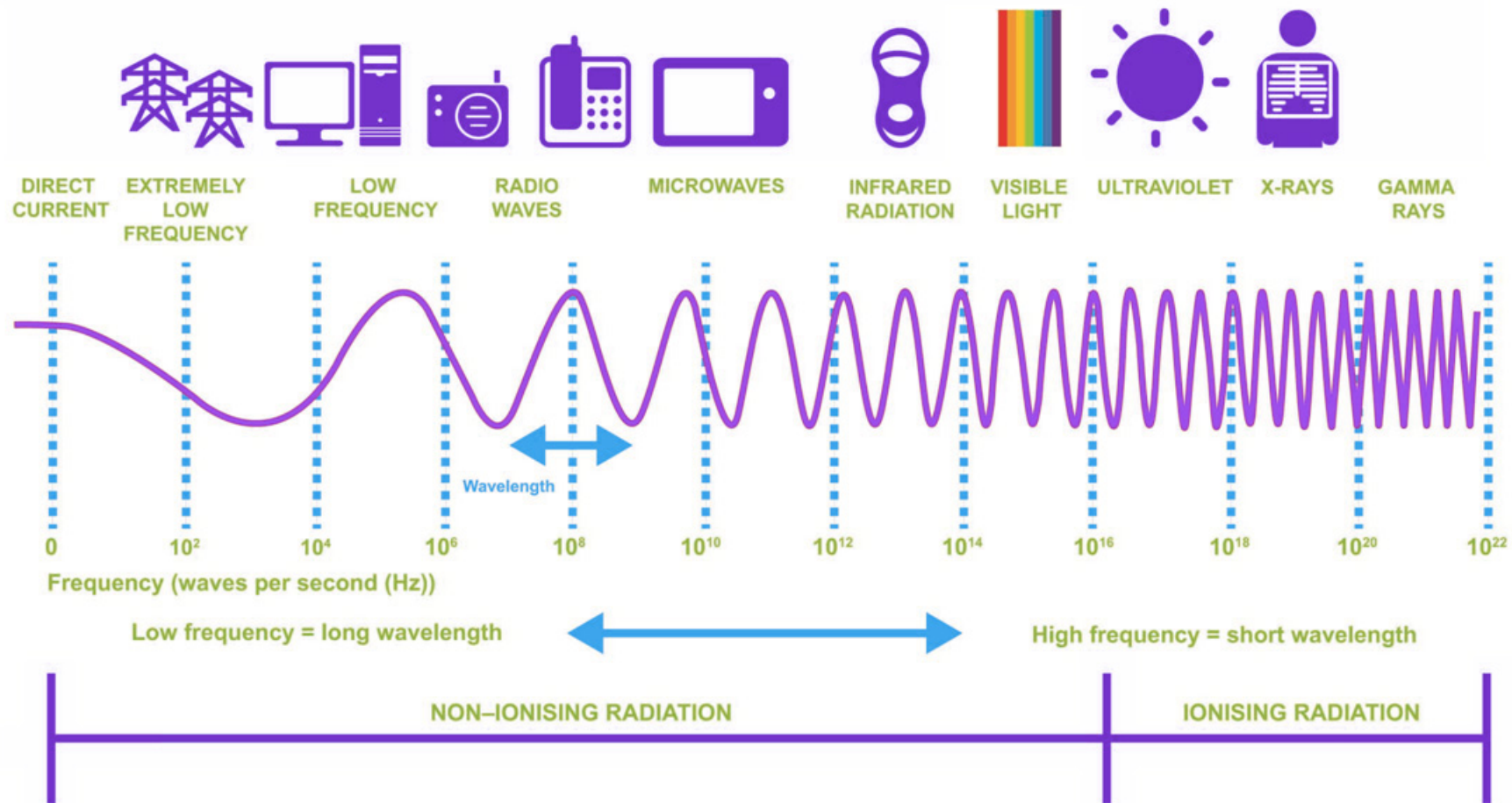

DRIFT TUBE LINAC (ALVAREZ LINAC)

- One style of RF cavity, used for the beginning stages of Fermilab's Linac (LINEar ACcelerator), which accelerates H⁻ ions to 400 MeV
- Metallic structure in which oscillating electric fields are produced and controlled
- When a charged particle encounters an electric field, it experiences a force (a "push")
- This push makes it gain a bit of energy and accelerates it
- But what about the part of the field that points in the "wrong" direction?

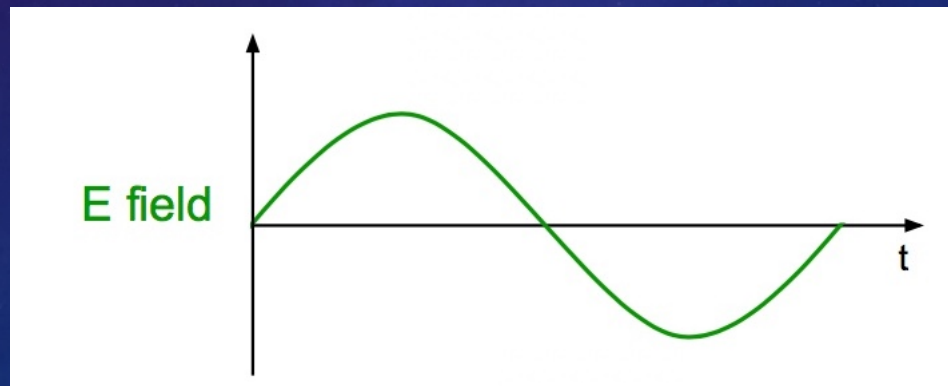

DRIFT TUBE LINAC (ALVAREZ LINAC)

- But what about the part of the field that points in the "wrong" direction?
- Drift tubes block out field
- As the particles travel faster and faster, they cover more distance in the same amount of time
- Drift tubes get longer and longer

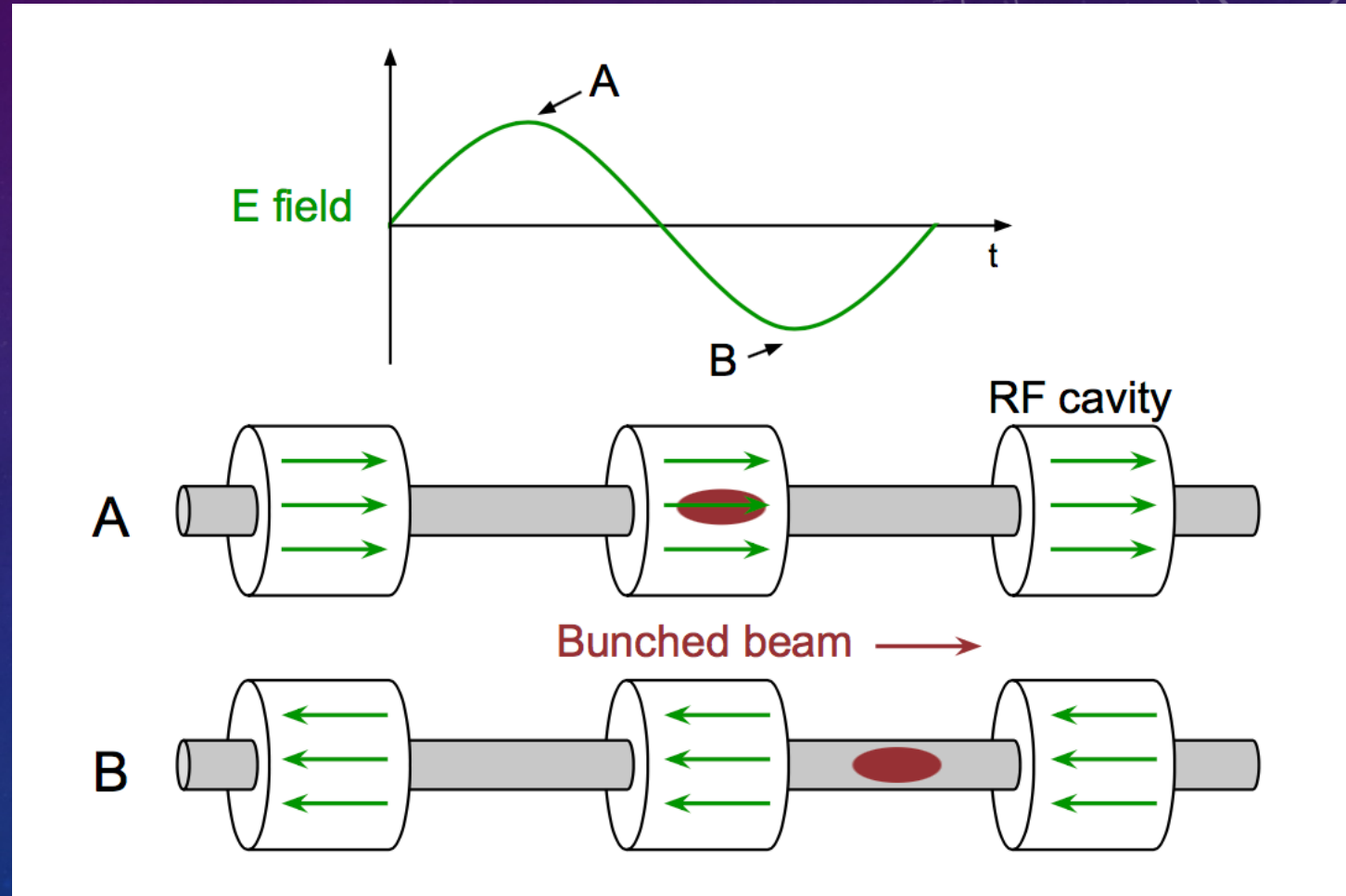

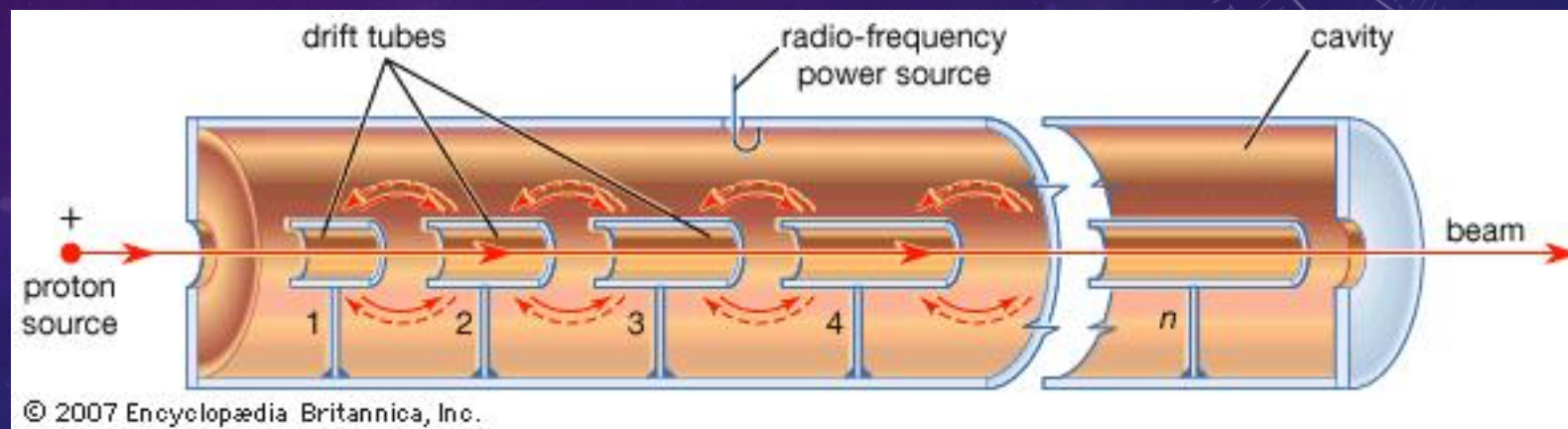





WE HAVE AN ACCELERATOR!

- Now we're in business. Nobel Prize, here we come!
- What if we want to hit very high energies?
- Stanford Linear Accelerator (SLAC)'s linac accelerated electrons up to 50 GeV in 2.0 miles—longest built
- LHC energy gets up to 13 TeV, which comes out to 260 SLACs or 520 miles, which is (direct) distance from Chicago to Rochester, NY

google.com

Chicago, Illinois
Rochester, New York
Add destination

OPTIONS

Send directions to your phone

via M-60 E 189 h
579 miles

- ⚠ This route includes a ferry.
- ⚠ This route crosses through Canada.
- ⚠ Your destination is in a different time zone.

↑ 4,170 ft · ↓ 4,265 ft

1,040 ft
312 ft

DETAILS

MICHIGAN

OHIO

PENNSYLVANIA

INDIANA

Map data ©2017 Google United States Terms Send feedback 50 mi

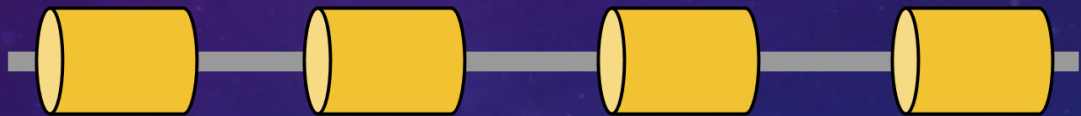



SO HOW DO YOU BEND A CHARGED PARTICLE?

- A charged particle bends in a magnetic field.

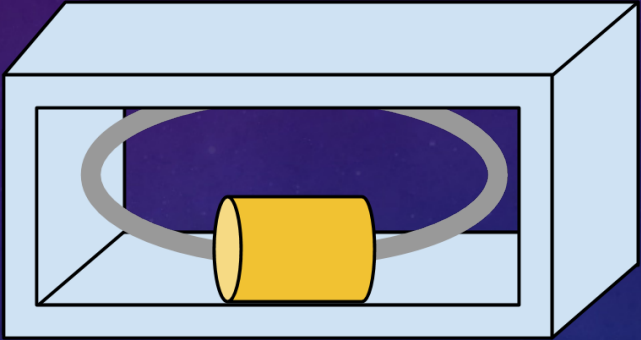

MAGNETIC FIELDS AND FORCES

- Moving charged particles (a.k.a. electric currents) produce magnetic fields
- Those fields interact with other moving charged particles and exert forces on them
- $\vec{F} = q \vec{v} \times \vec{B}$: the Lorentz Force
 - “Right hand rule” (for positive particles)

A QUICK NOTE ON NOTATION: ARROWS

- Up, down, left, right
- Out of the page: \odot
- Into the page: \otimes
- Imagine looking at an arrow end-on

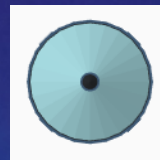

Pointing at you
(out of page)

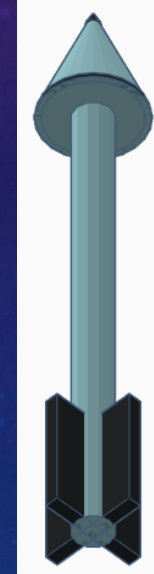
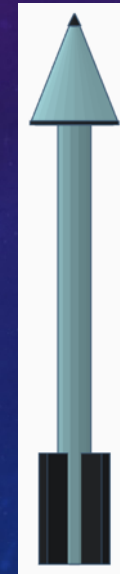
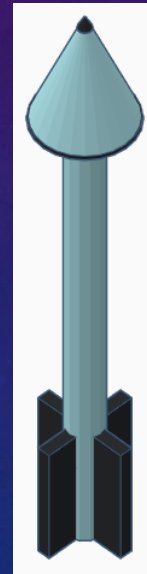

Pointing away from you
(into page)

THE RIGHT HAND RULE

There is a version of this for magnetic fields:

1. *Magnetic Field* Right Hand Rule: gives you the direction of the magnetic **FIELD formed** by current flowing through a wire

- This is how electromagnets work

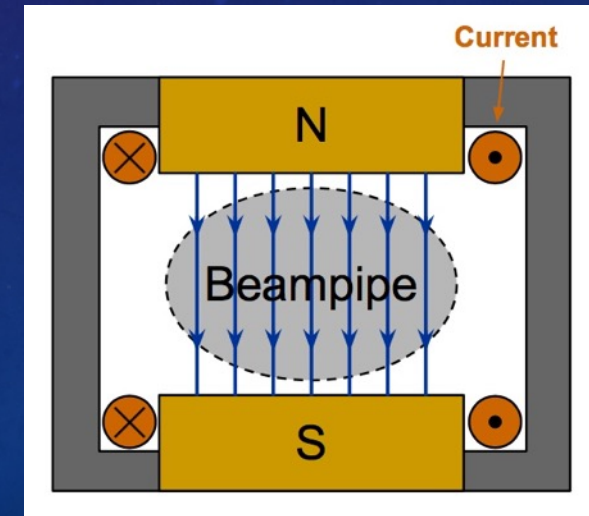
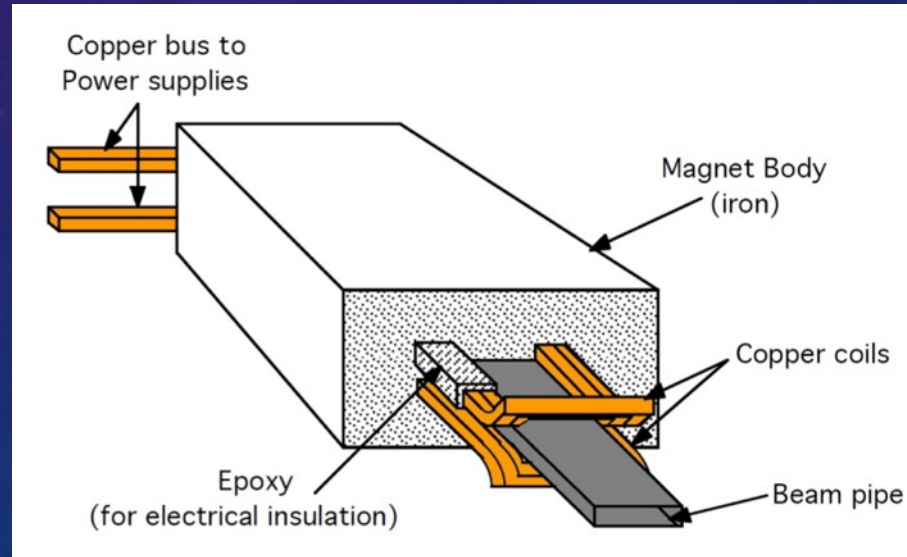
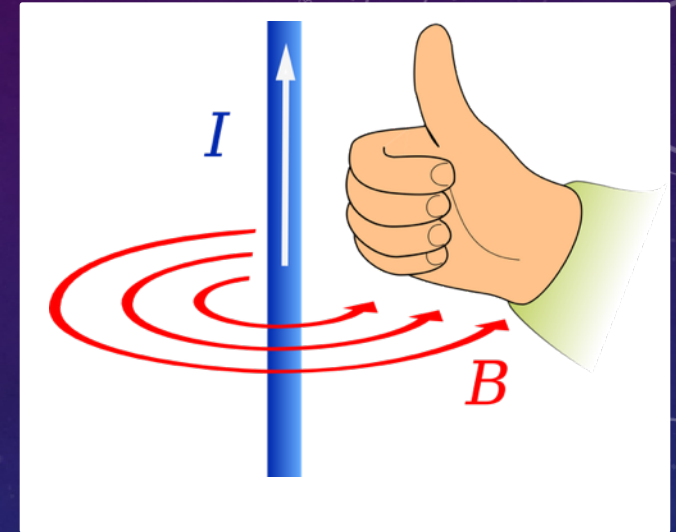

THE RIGHT HAND RULE

But the one I want to focus on is this:

2. *Lorentz Force* Right Hand Rule: gives you the direction of the **FORCE exerted** by a magnetic field on a charged particle

- Gives you direction of the force F in $\vec{F} = q \vec{v} \times \vec{B}$
- Point fingers in direction of \vec{v}
- Curl them in direction of \vec{B}
- Thumb is pointing in direction of \vec{F}

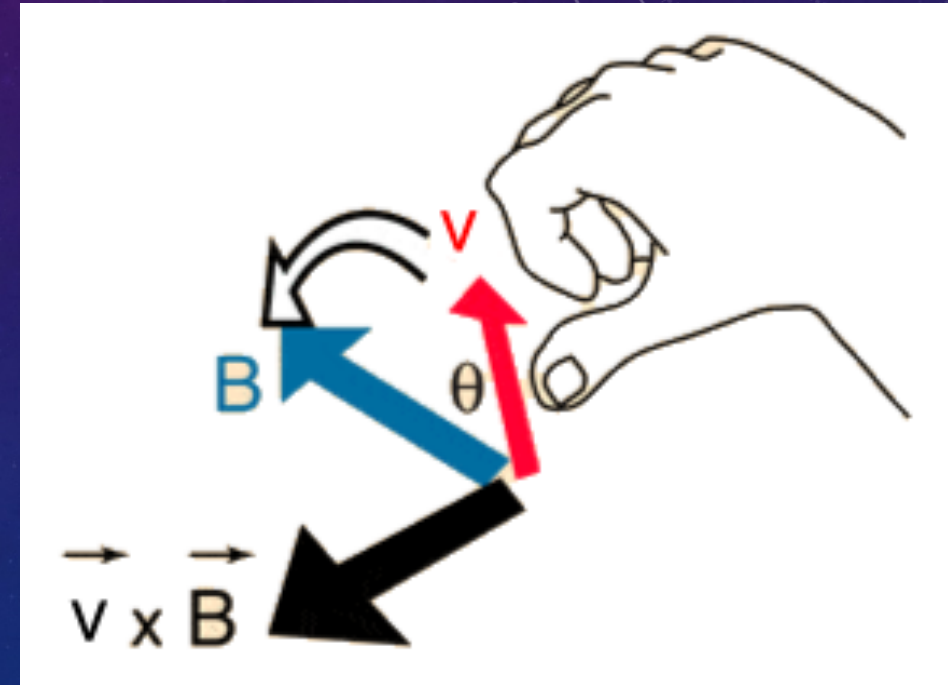

QUESTION

- Suppose a charged particle traveling up (in the drawing) enters a magnetic field pointing into the page/screen.
- Which drawing best represents the path the particle will take after entering the magnetic field?

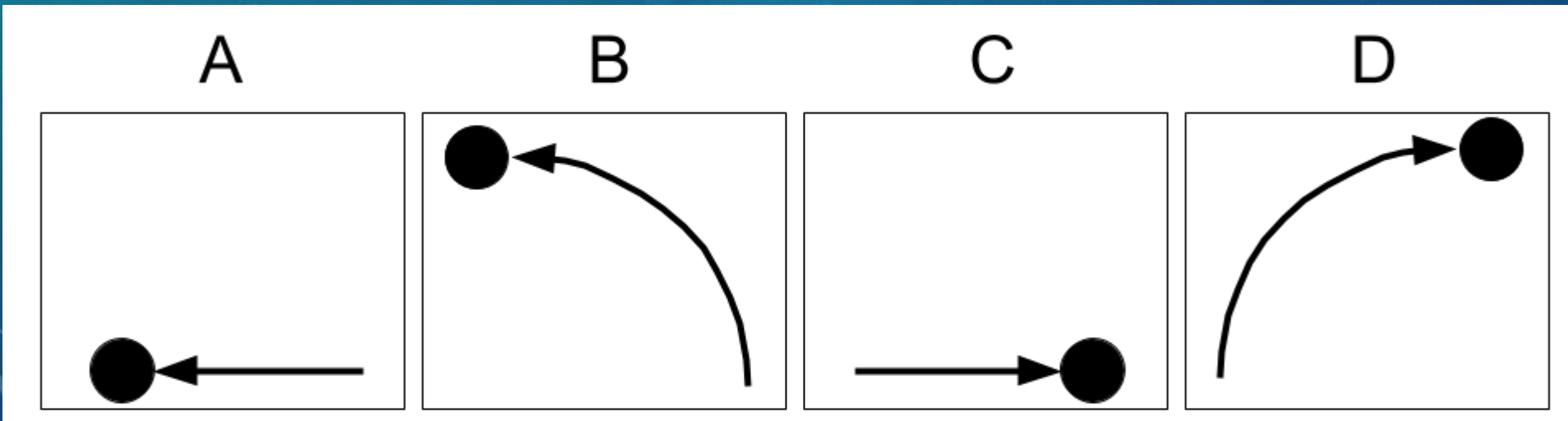
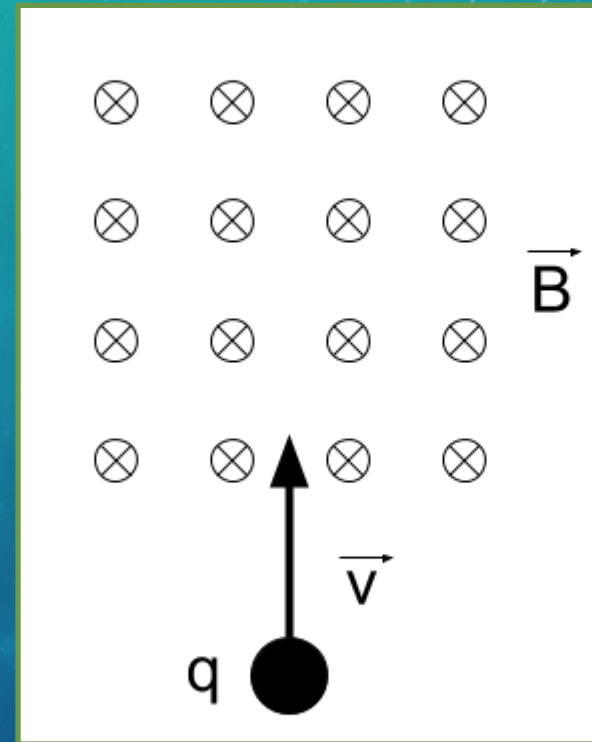

ANSWER

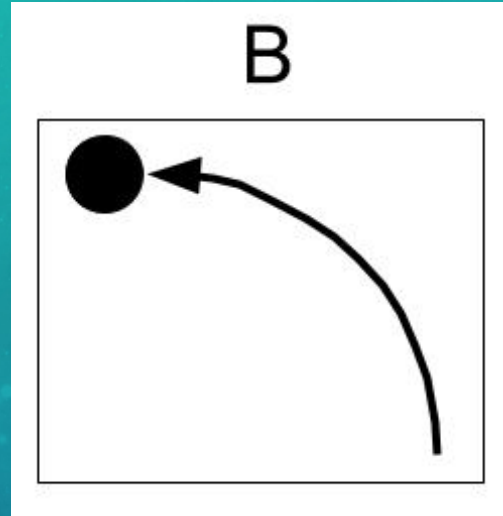

- Use the Lorentz Force Right Hand Rule to find out the force resulting from the magnetic field
- The force a particle experiences from the magnetic field is always perpendicular to its direction of motion
- So it doesn't make it go faster, it doesn't make it slow down, but it does make it continuously steer to the left (**while still going forward**)
- This results in a circular motion

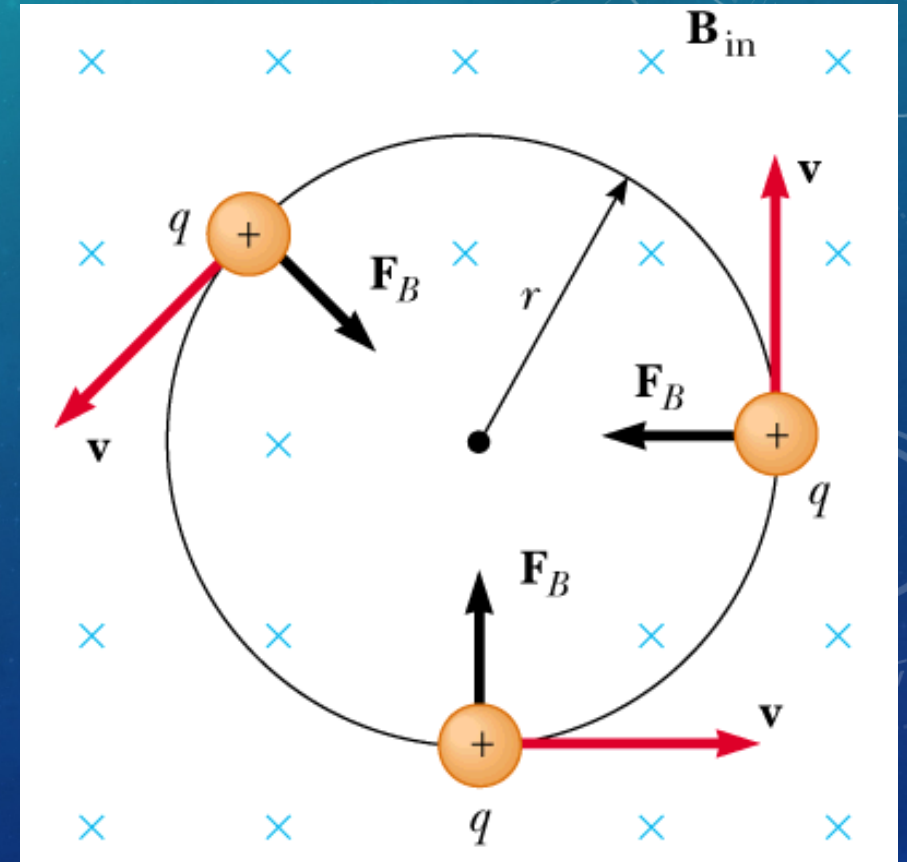

QUESTIONS?

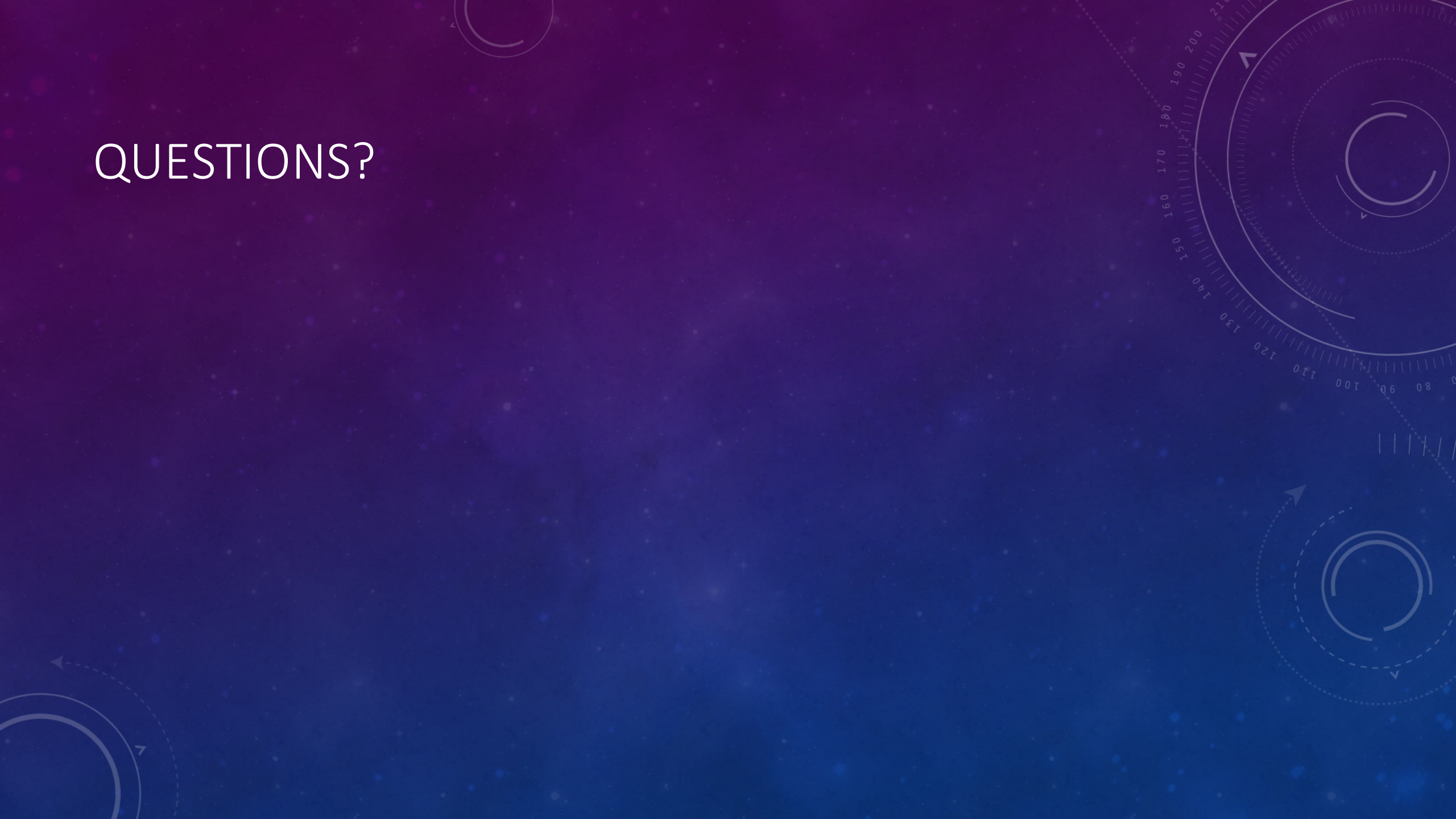



Fine beam tube/Helmholtz coil demonstration

- The tube generates an electron beam using a hot filament/cathode, “Wehnelt Cylinder”, and accelerating anode.

$$eV = \frac{1}{2}mv^2 \rightarrow v = \sqrt{\frac{2eV}{m}} \propto \sqrt{V}$$

$$V = 150\text{V} \rightarrow v = 7.3 \times 10^6 \text{ m/s} = .024c$$

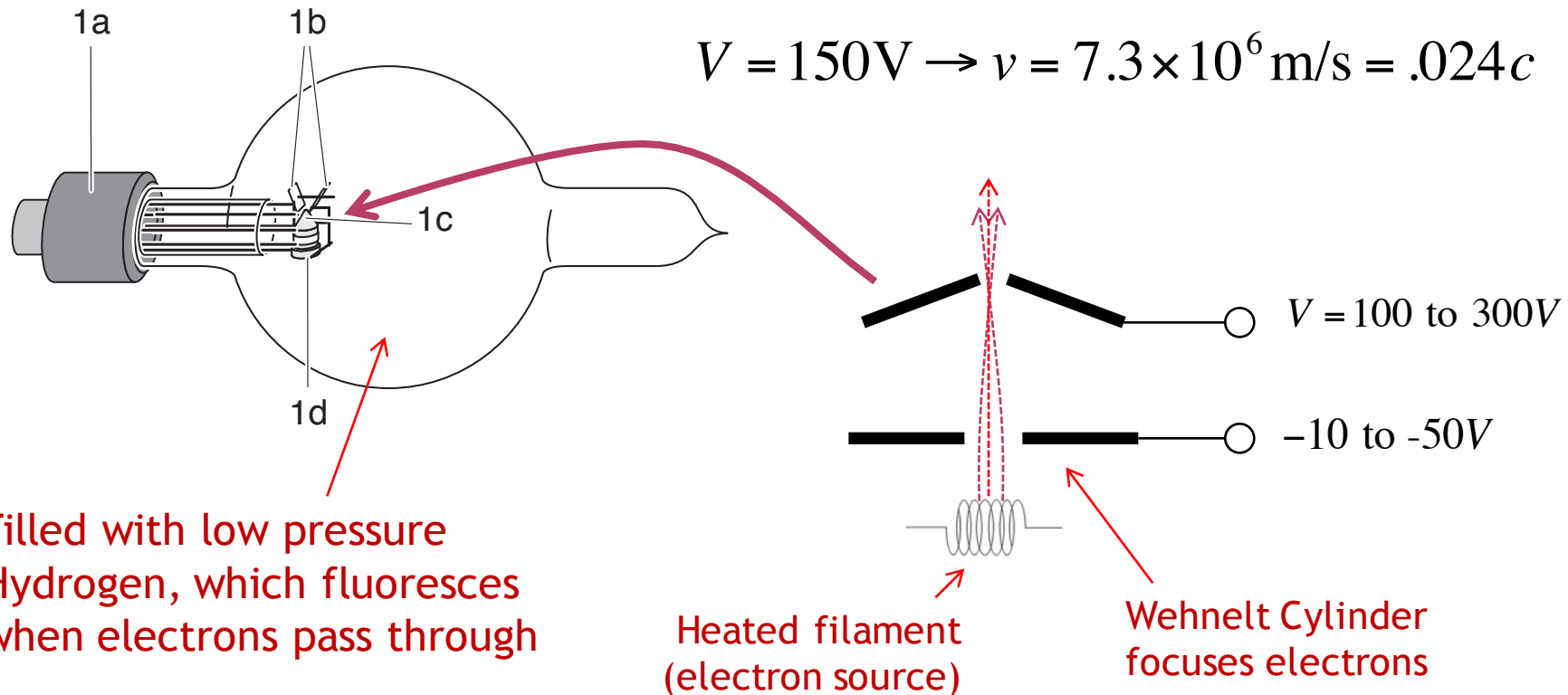

Demo (cont'd)

- ◉ The Helmholtz Coils produce a ~uniform magnetic field

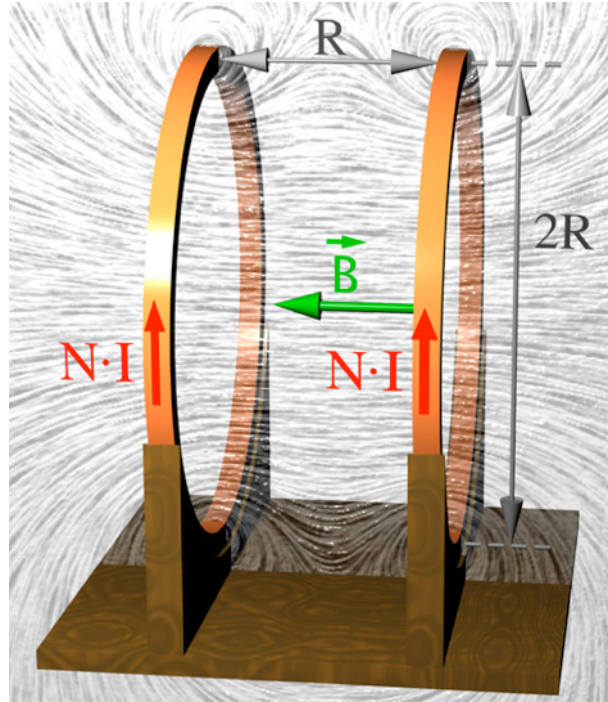

$$B = \left(\frac{4}{5}\right)^{\frac{3}{2}} \frac{\mu_0 NI}{R} \propto I$$

$$\rho = \frac{mv}{eB}$$

$$\propto \frac{v}{B}$$

$$\propto \frac{\sqrt{V}}{I}$$

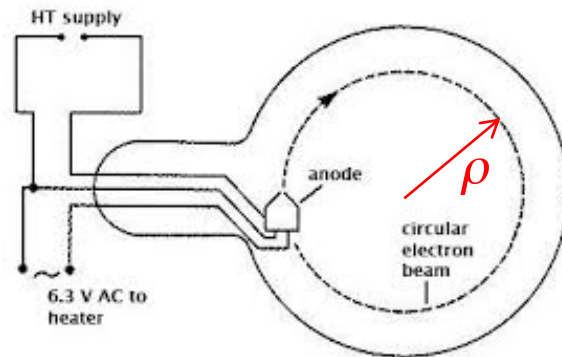

CYCLOTRON

- Charged particles react to an electric field by accelerating
- They react to a magnetic field by changing their direction
- The cyclotron uses:
 - A split RF cavity (Dees) with an accelerating gap in the middle and oscillating electric field
 - Two large magnets to produce a uniform magnetic field perpendicular to the direction in which the particles travel
- Characteristic spiral pattern as particle accelerates and radius of curvature gets larger
- Often used today for medical purposes: proton therapy, production of medical isotopes. Compact, cost-effective, reliable.

The Cyclotron (1930's)

- A charged particle in a uniform magnetic field will follow a circular path of radius

$$\rho = \frac{p}{qB} \approx \frac{mv}{qB} \quad (v \ll c)$$

$$f = \frac{v}{C} = \frac{v}{2\pi\rho} = \frac{v}{2\pi} \frac{qB}{mv}$$

$$= \frac{qB}{2\pi m} \quad (\text{constant!!})$$

For a proton:

$$f_c = 15.2 \times B[T] \text{ MHz}$$

i.e. "RF" range

would not work for electrons!

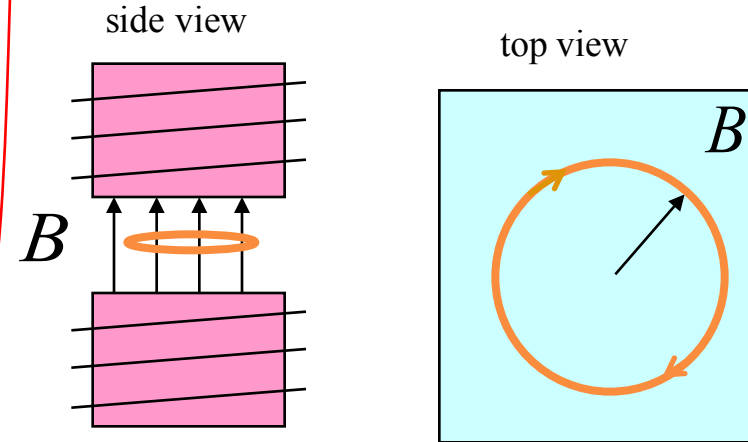

"Cyclotron Frequency"

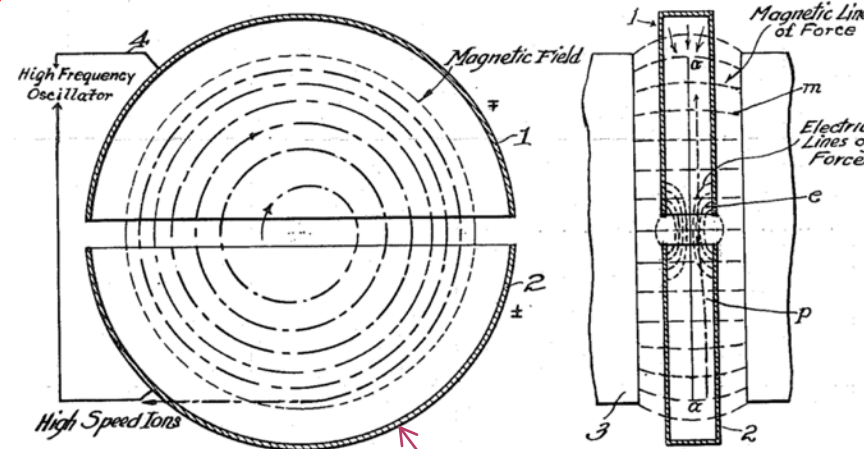

Accelerating "DEES": by applying a voltage which oscillates at f_c , we can accelerator the particle a little bit each time around, allowing us to get to high energies with a relatively small voltage.

Cyclotron

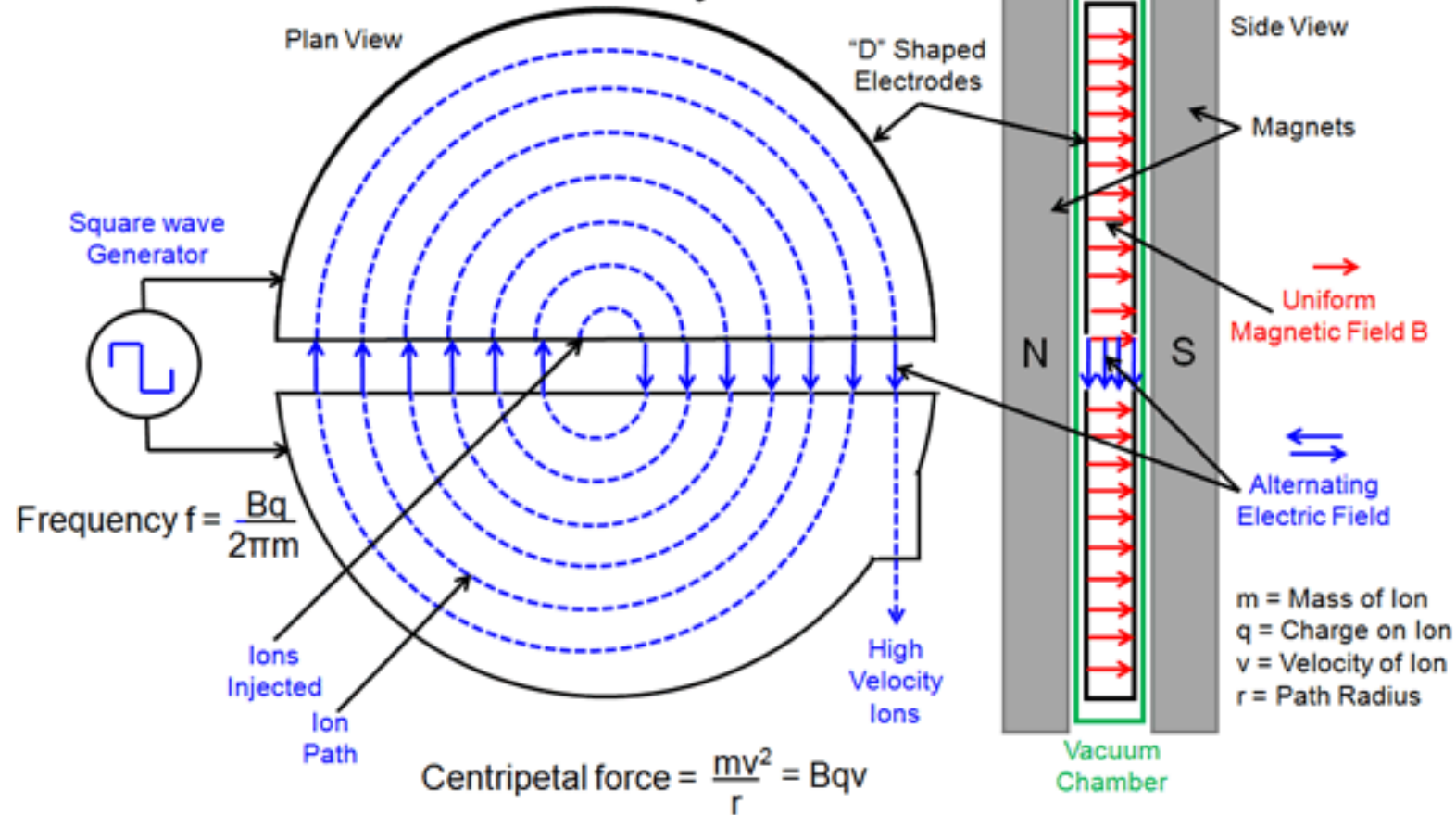

Note that the accelerating field frequency is independent of the particle velocity and the path radius

E. O. LAWRENCE'S CYCLOTRON



1939

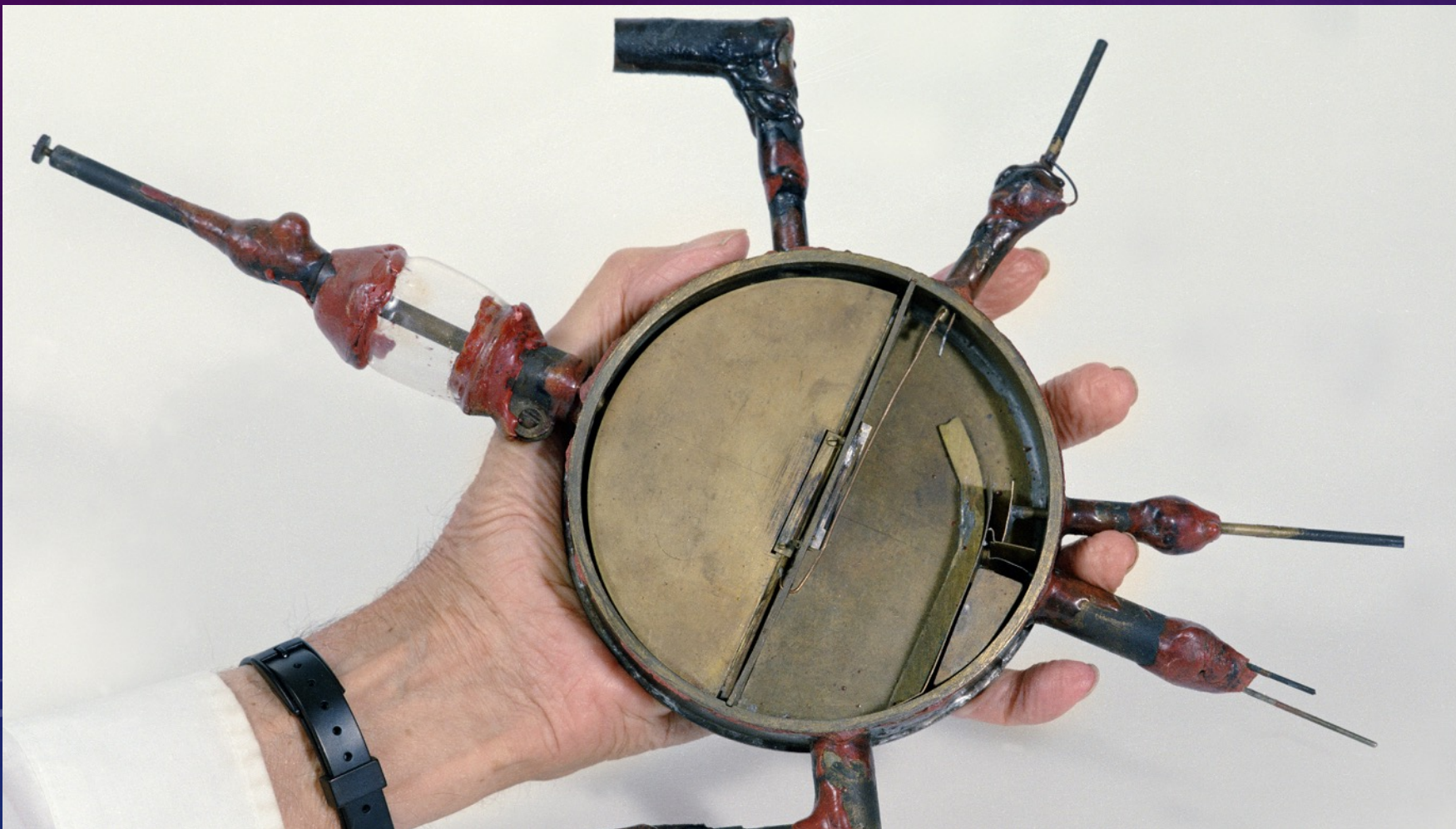

103

Lr

LAWRENCIUM

1961



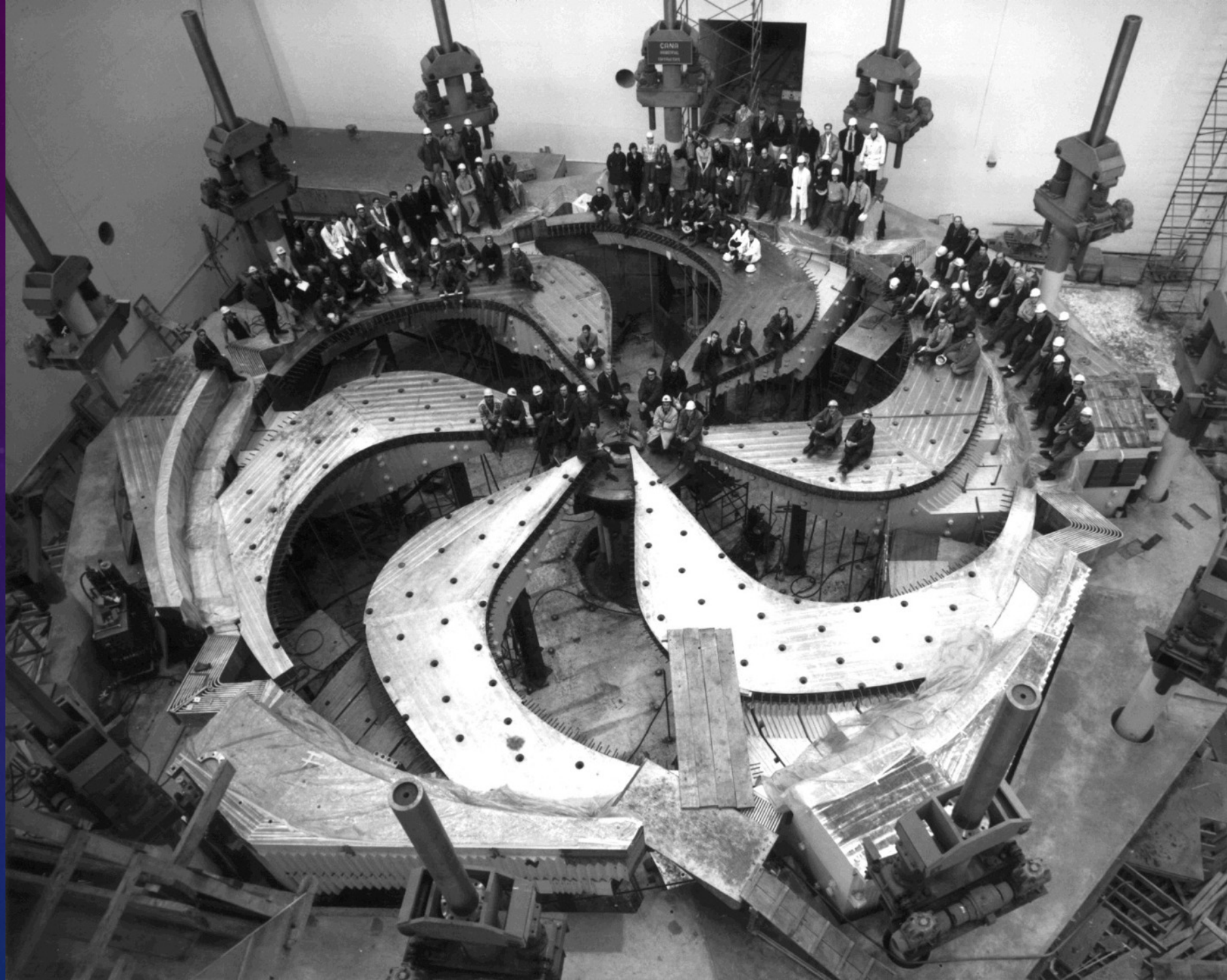

HOW MUCH BIGGER CAN YOU GO?

- It would be great if we could use smaller magnets, re-use magnets
- In fact, it would be great if we could get the beam to trace out exactly the same path, no matter what energy it is. Then you could re-use everything.

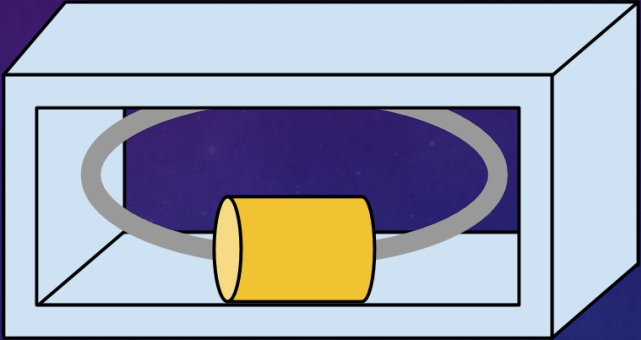



SYNCHROTRON

- The cyclotron has a uniform magnetic field, so as the particles accelerate, they trace out larger and larger circles
- What if we wanted the radius to stay the same? Increase the magnetic field as the particles go faster and faster. If done in a synchronized manner, the particles take the same path.
- The highest energy machines are all synchrotrons
- Fermilab's Main Ring and then Tevatron (1983-2011), the LHC at CERN

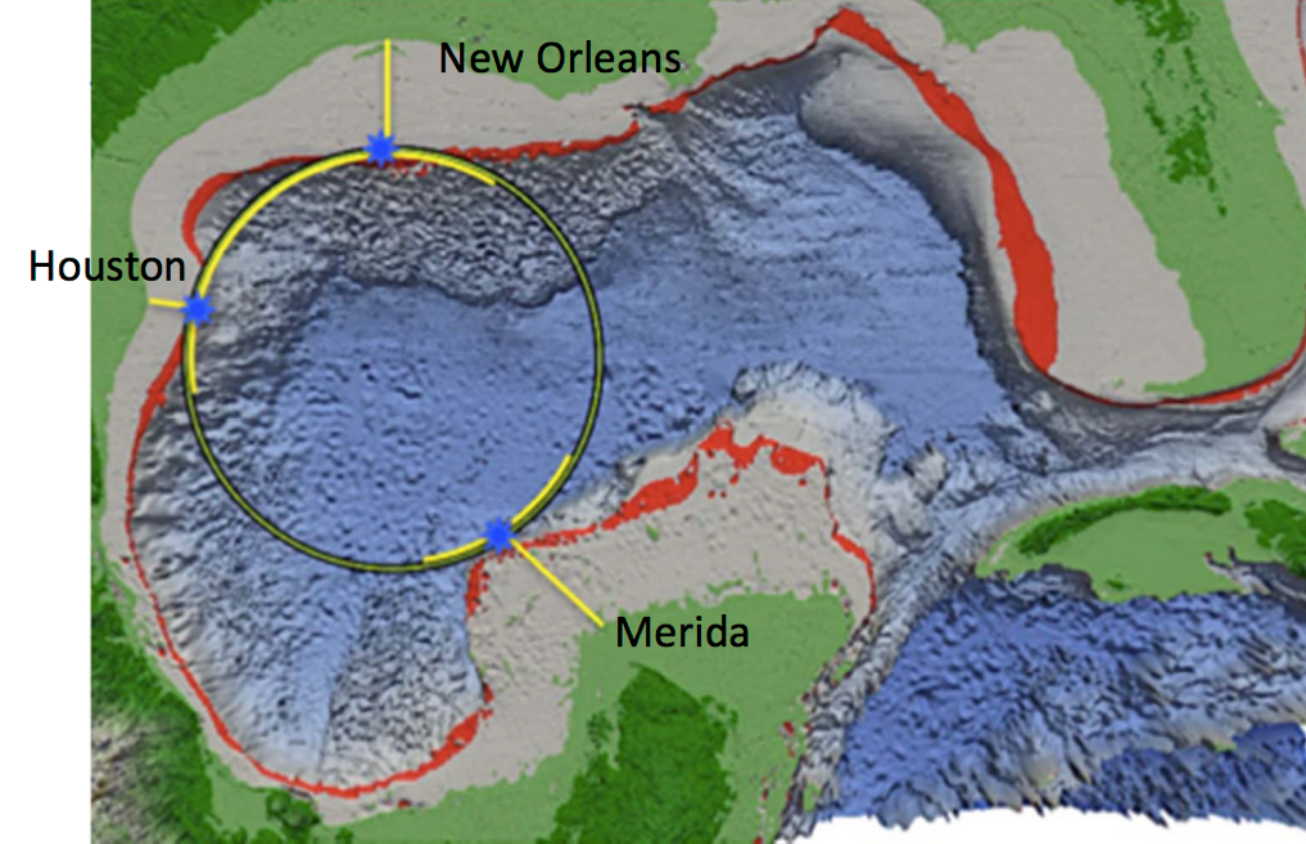

S. Assadi et al, Accelerator Research Lab at Texas A&M University, from a talk given at NAPAC 2016

Theoretical...for now

Special Collections Research Center, University of Chicago Library, from a 1954 talk given by Enrico Fermi

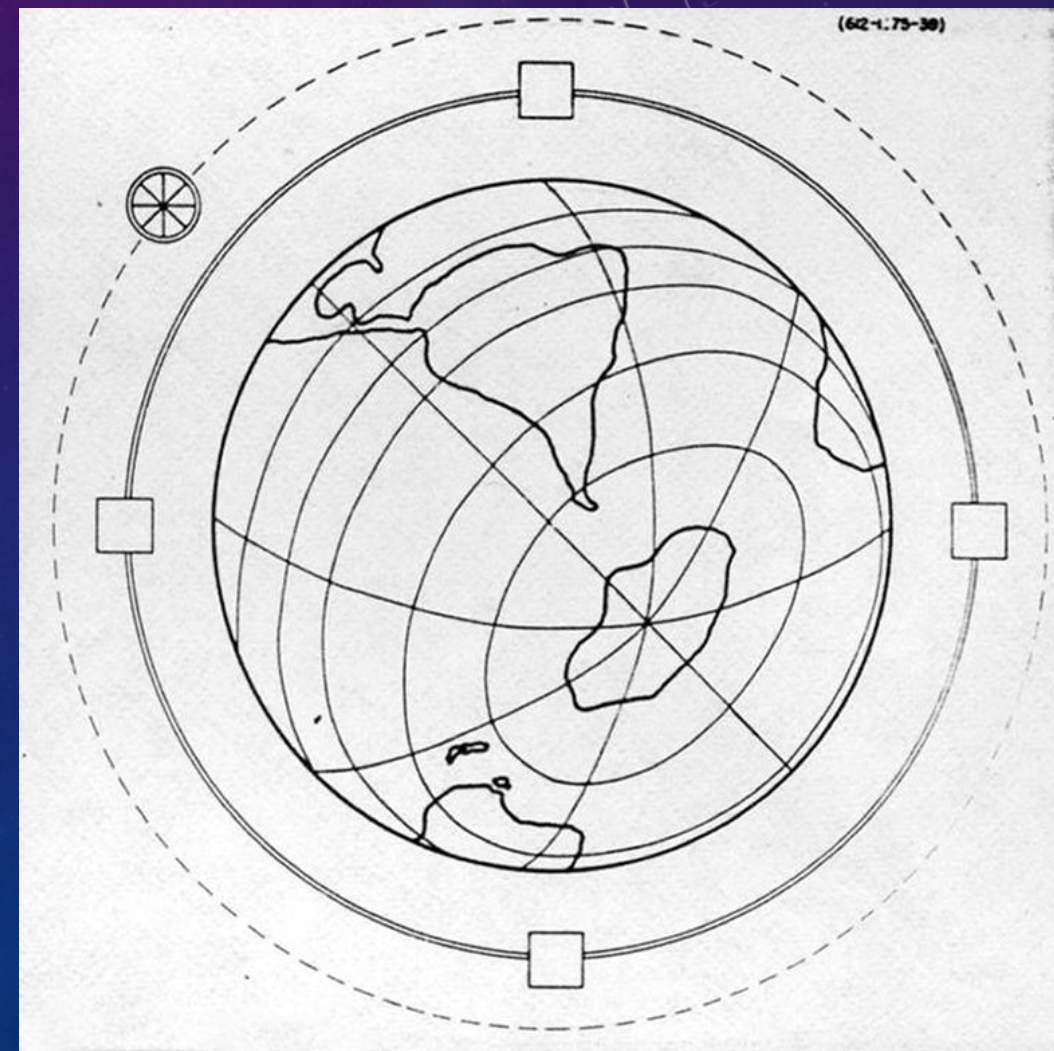

OTHER PRACTICAL CONCERNS?

- (And questions?)

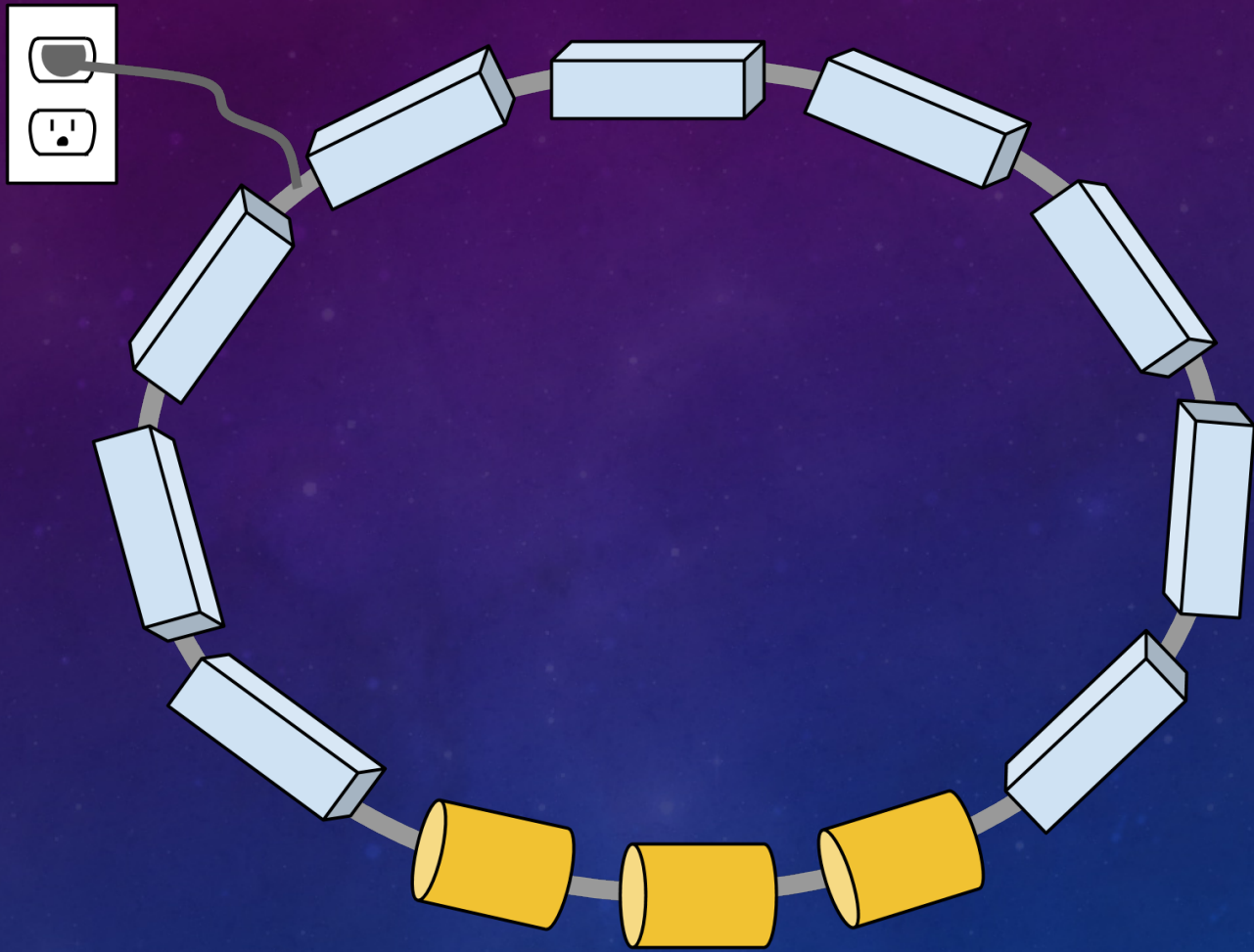

HIGH VOLTAGE

- Everything runs on electricity! LOTS of electricity.
- Contrary to popular belief, we do not make our own electricity—we buy it from the electric company like everybody else
- Power supplies of various sorts may put out up to 200,000 A (1 A = a toaster!) for high-current applications or 30,000 volts or more for high-voltage applications
- Any interruption to power is debilitating (lightning strikes...water leaks...snakes...)



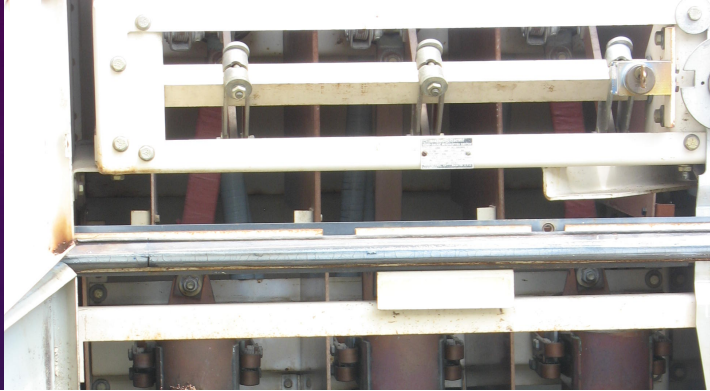

CENSORED
For Excessive Snake Content



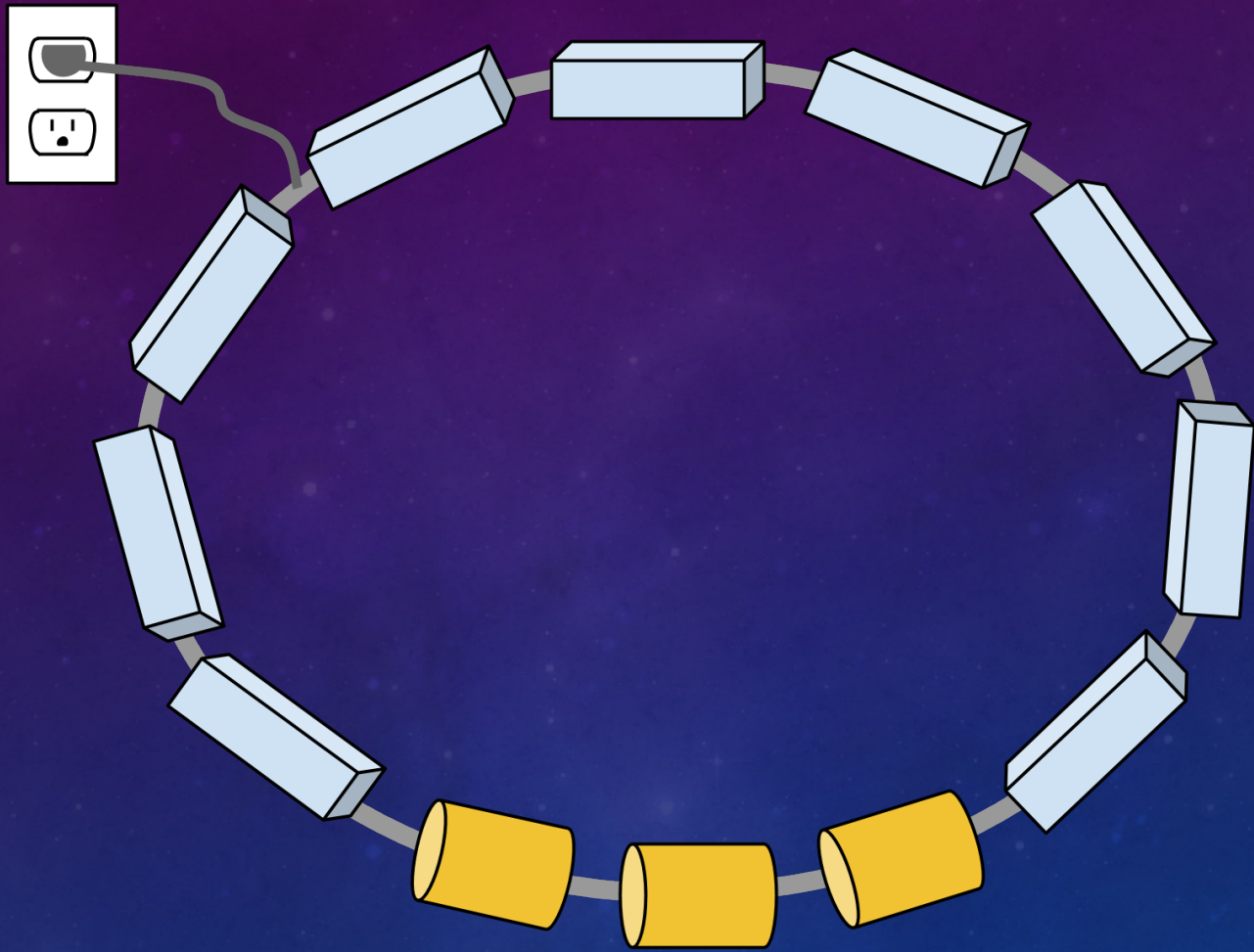

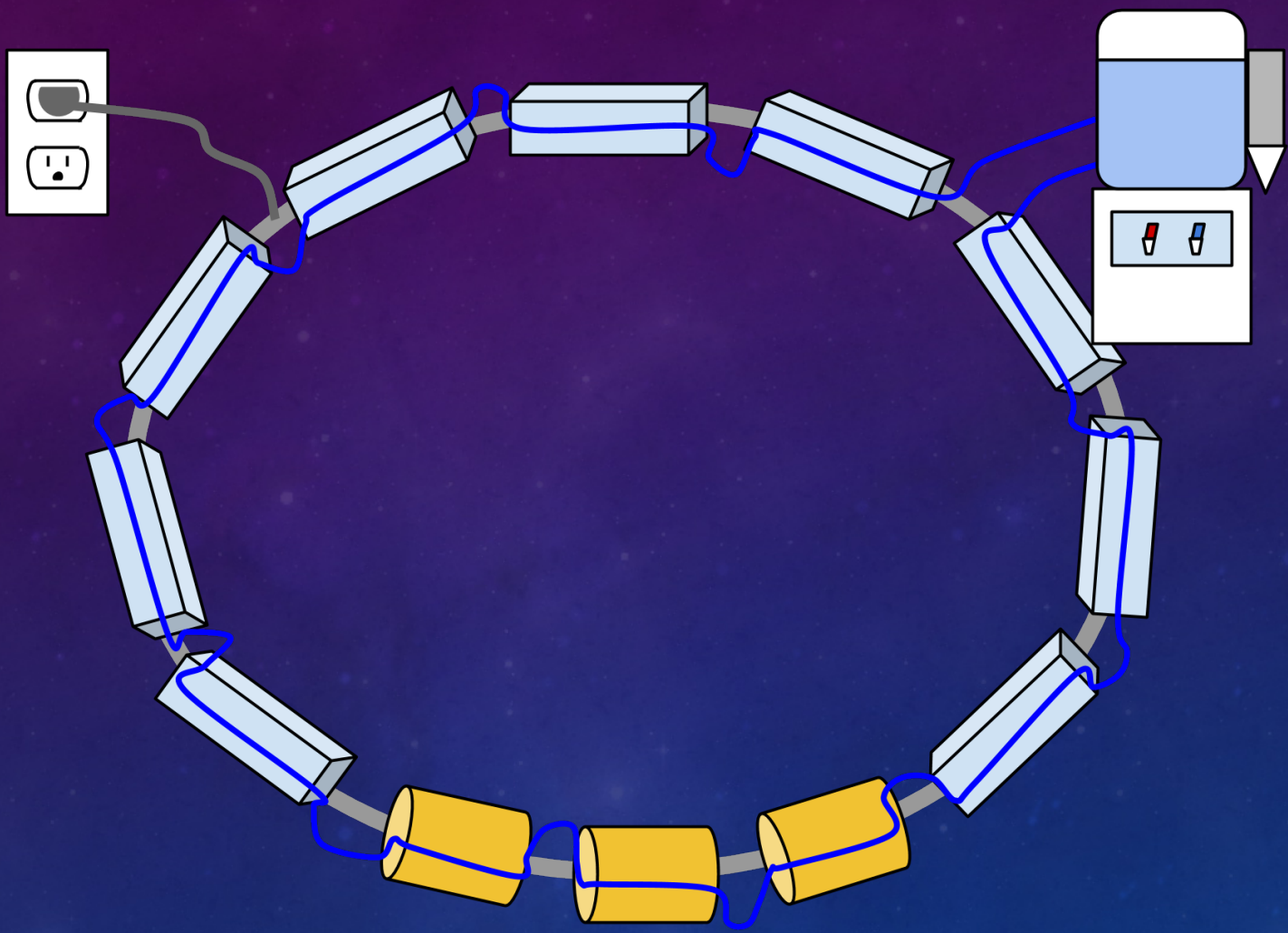

COOLING (LCW)

- Power supplies, magnets, RF cavities, and other components get so hot while in use that they often need cooling.
- LCW = Low Conductivity Water
- LCW can be pumped safely through electrical systems for cooling.
- Cooling water carries the heat away and heat exchangers allow us to discharge the heat elsewhere.

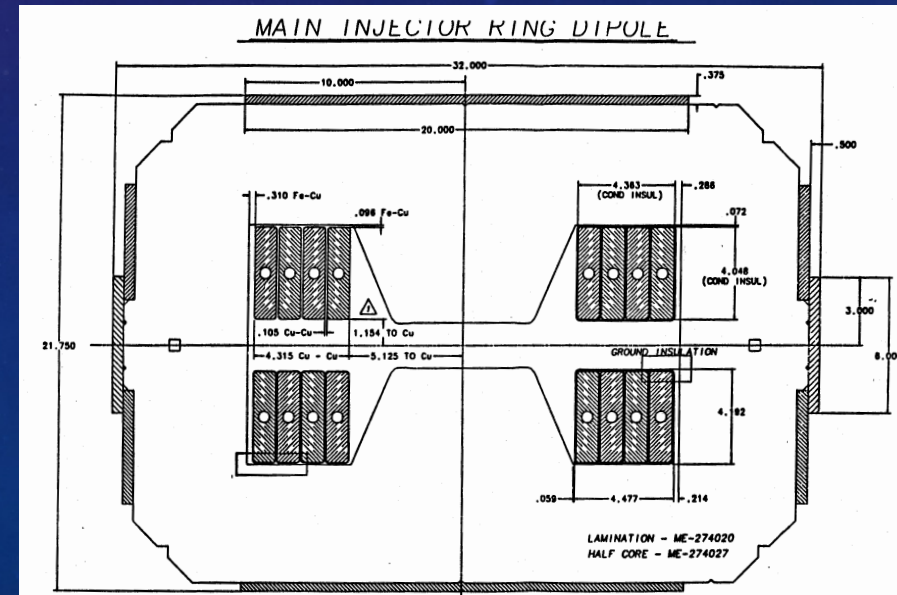
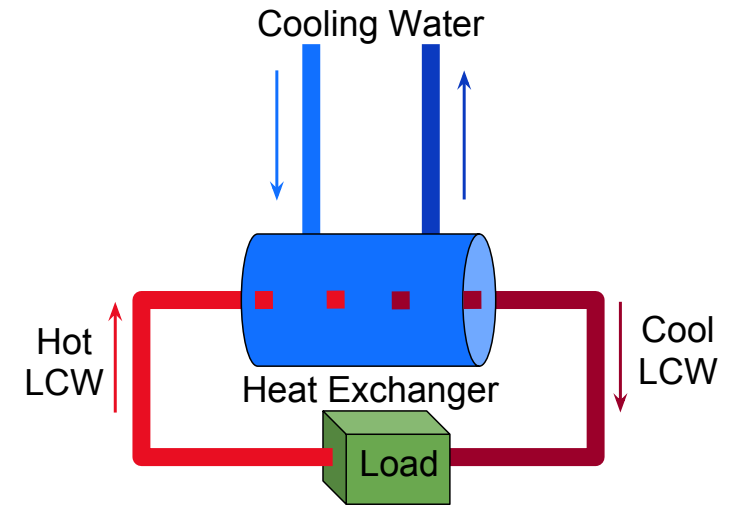



Picture by Elliott McCrory

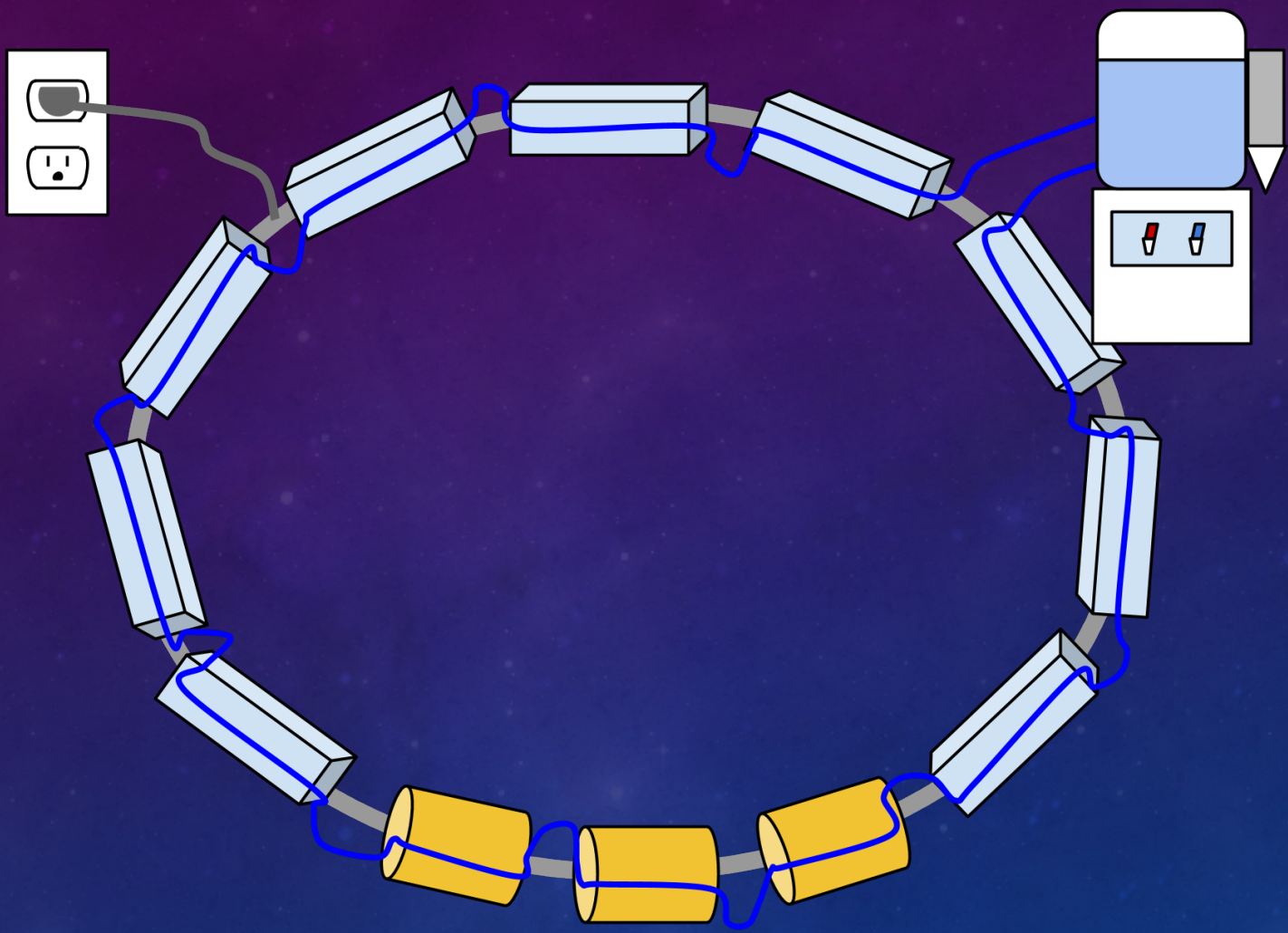

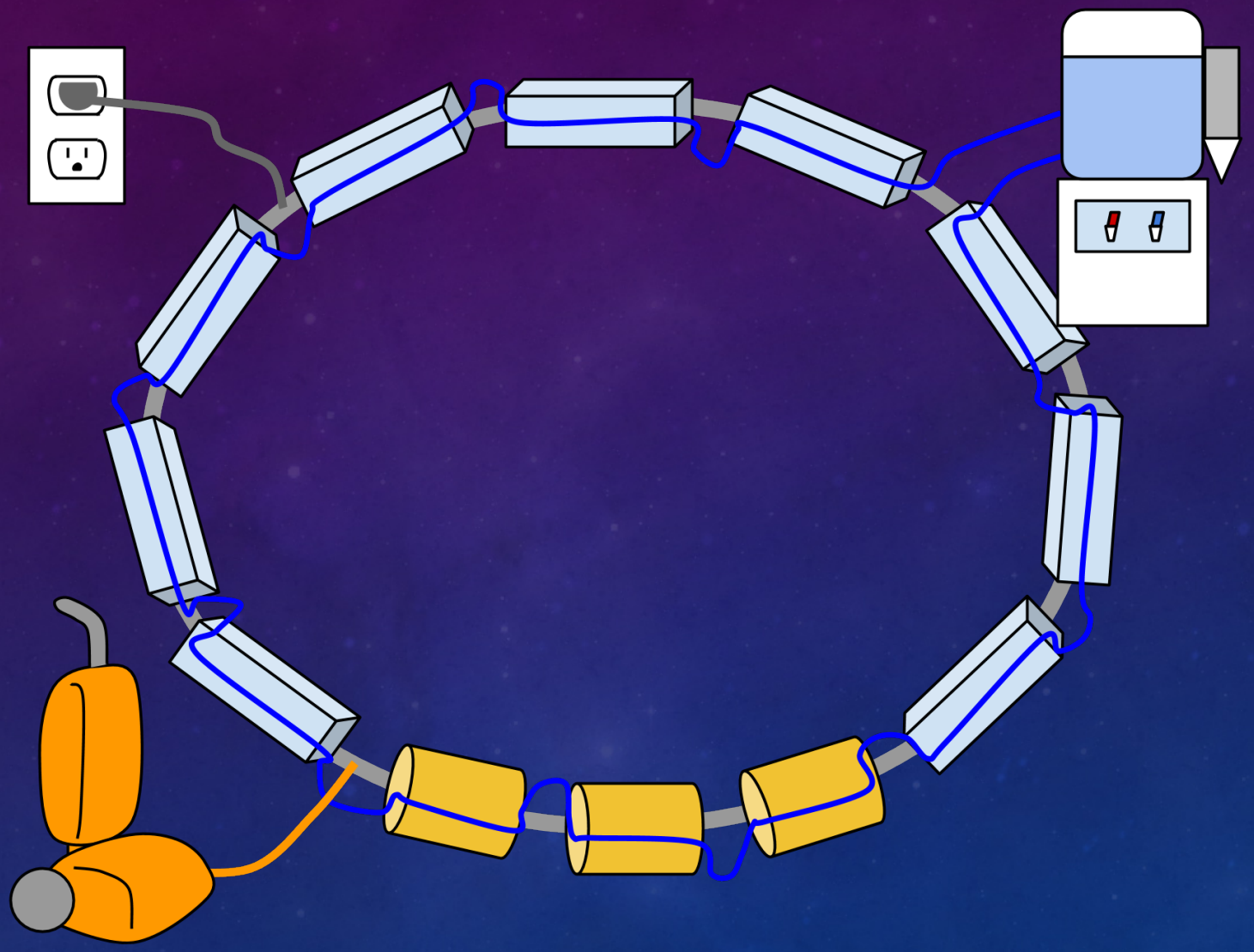

VACUUM

- Empty the beampipe of everything but beam, and maintain that emptiness
- In some cases we pump down to vacuum levels like that in outer space around Earth's moon
- Different kinds of vacuum pumps: roughing, turbo, ion
- Even cryogenics, used in superconducting applications, can provide vacuum improvement: by freezing stray gases solidly to the sides of the beampipe

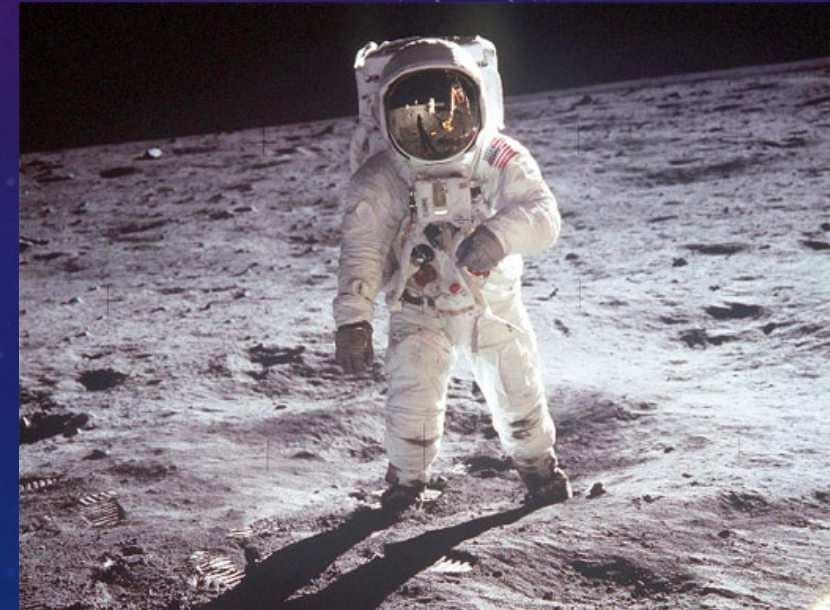

CONTROLS, DIAGNOSTICS, & INSTRUMENTATION

- Also, we need a way to see what's going on!
- Feed back information about what's going on with the accelerator components and the beam
- Ways to make changes, corrections, and adjustments

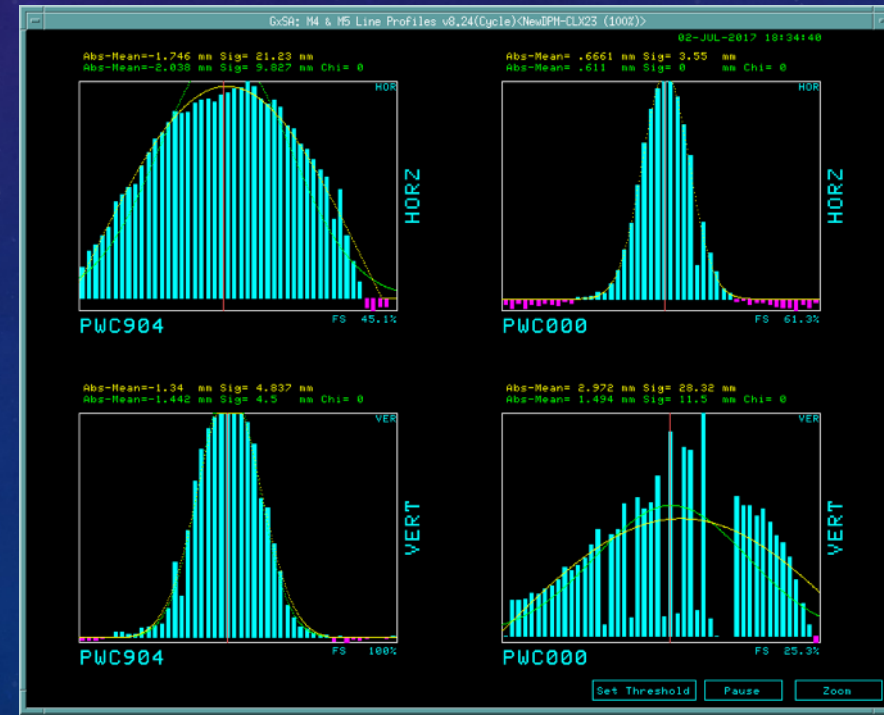

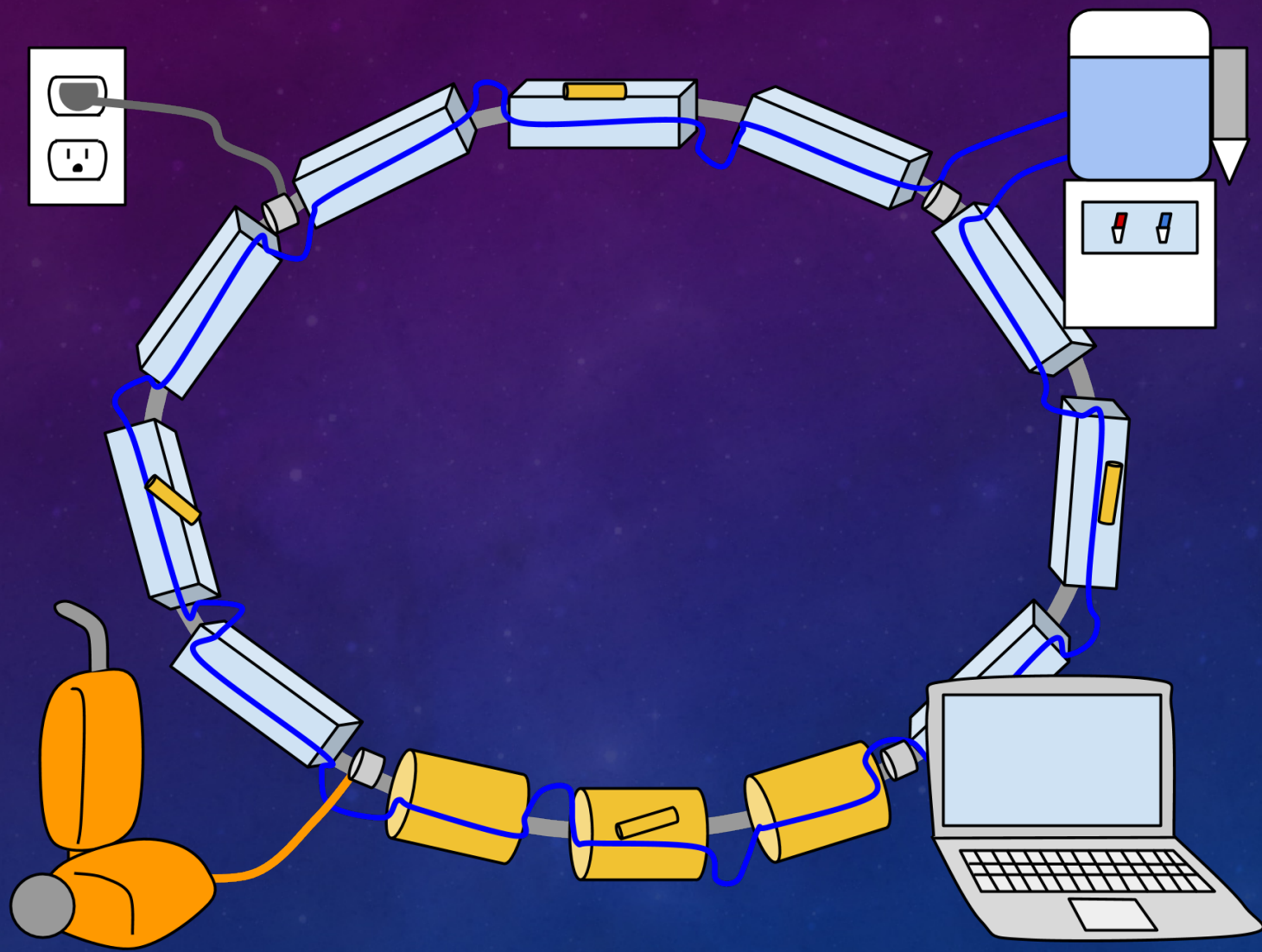

THE REAL WORLD

- As in, not the theoretical design world
- Things work imperfectly, things go wrong. You have to figure out how to run your machines and solve problems anyway!
- There is science to be done!

ACCELERATOR OPERATIONS

- You might have been on a tour of including the Linac and Main Control Room, where Fermilab's operators monitor the beam and the entire accelerator complex 24/7/365.
- I talk more about this in my 2015 Fermilab Physics Slam presentation

2015 Physics Slam - Cindy Joe - YouTube



▶ 10:18

https://www.youtube.com/watch?v=gb1pTjF_sVg ▼

Dec 2, 2015 - Uploaded by Fermilab

Cindy Joe, Accelerator operator at Fermilab, makes her presentation on a day in her life at the 2015 Fermilab ...



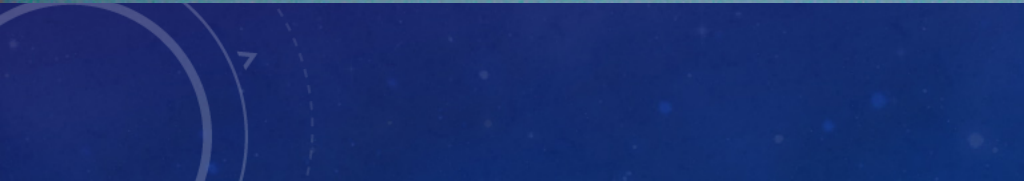

September – December, 2017

We also have a full [description of these talks](#) and of our speakers.

Date	Topic (Click for Slides)	Speaker (Click for Photos)	Tours
Sept 23*	Fermilab Open House (<i>Registration is separate from SMP registration</i>)		
Sept 30	Introduction to Science at Fermilab	Dan Hooper University of Chicago	G1 & G3: Wilson Hall, G2 & G4: Accelerator Division
Oct 7	Einstein and the Modern Physics Revolution	Elliott McCrory Fermilab Accelerator Division	G1 & G3: Accelerator Division, G2 & G4: Wilson Hall
Oct 14	Particle Physics	Cecilia Gerber University of Illinois at Chicago	G1 – DZero G2 – SiDET G3 – Neutrino G4 – GCC
Oct 21	Accelerators	Cindy Joe Fermilab Neutrino Division	G1 – SRF G2 – Neutrino G3 – GCC G4 – DZero
Oct 28	Cosmology	Brian Nord Fermilab Particle Physics Division	G1 – Magnets G2 – GCC G3 – DZero G4 – SRF
Nov 4	Neutrinos	Leo Aliaga Fermilab Scientific Computing Division	G1 – SiDET G2 – DZero G3 – SRF G4 – Magnets
Nov 11	Detectors: Seeing the invisible	Angela Fava Fermilab Neutrino Division	G1 – Neutrino G2 – SRF G3 – Magnets G4 – SiDET

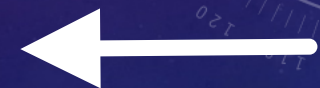

BONUS: A RIDE THROUGH AN ELECTRON ACCELERATOR



GoPro Ride Through an Electron Beam Irradiator at Full Beam Power (GOPR0111trim)

107 views

3 1 SHARE ...



Andrew Seltzman

Published on Dec 11, 2016

SUBSCRIBE 256

Beam parameters: 3.0MeV, 50mA

Radiation shielded Gopro Hero 3+ Silver is sent through electron beam irradiator. Looking at calcite samples as they pass under the beam. GoPro is enclosed in a 1/4" thick lead box with a 1/2" thick,

SHOW MORE

<https://www.youtube.com/watch?v=THB-xs11juM>

A FEW THOUGHTS GOING FORWARD

- There is so much I didn't have time to get into! Explore on your own, ask questions.
- Encouragement!
 - Stay curious.
 - It's OK to ask "stupid" questions.
 - It's more important to gain knowledge (and become smarter) than to look smart to other people.
 - Smart people will know and respect this!
 - Be brave! Seek out what's hard and makes you smarter and stronger.

THANKS TO

- Dan, Elliott, Cecelia, and past speakers Eric Prebys for ideas and material
- AD Operations and too many others to thank for learning, inspiration, and material
- The SMP organizers for asking me to talk and making this program possible
- You, for sharing this with me. I hope we get that Nobel Prize together someday.
- Questions?

