

Finite quark mass effects for the production of Higgs-boson with Dijet

Marian Heil,

with J. R. Andersen, A. Maier and J. M. Smillie

arxiv:1812.08072

IPPP, Durham

QCD@LHC 2019, Buffalo 15/07/2019



Higgs to gauge boson coupling

- Distinction between WBF and gF

⇒ Small quantum interference

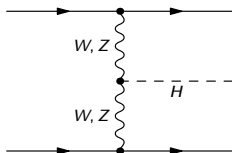

Coupling:

Add. emission:

Known Fixed Order:

h to Z/W

on external quark

NNLO

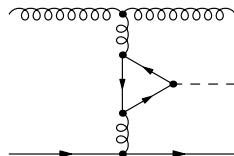

top-loop

on t-channel gluon

LO with finite m_t

NLO with $m_t \rightarrow \infty$

⇒ experimental result still *work in progress*

Weak boson vs. Gluon fusion

Invariant jet mass

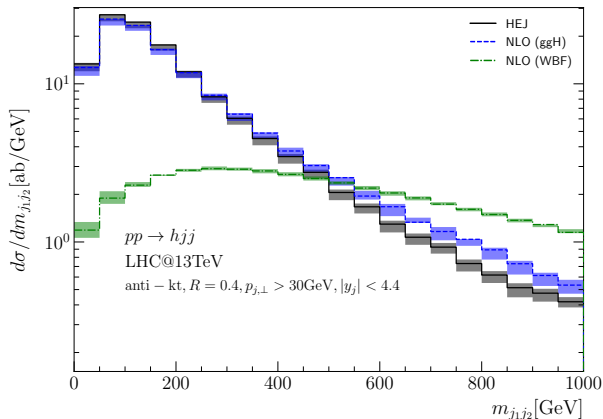

- gF dominated by initial gluon \Rightarrow Peak at low m_{12}
- \Rightarrow VBF-cut: $m_{12} > 400 \text{ GeV} \ \& \ y_{j_1j_1} > 2.8 \Rightarrow$ reduce gF by $\sim 90\%$
- \Rightarrow Sensitive to High Energy Effects

arxiv:1803.07977

Weak boson vs. Gluon fusion

Rapidity separation

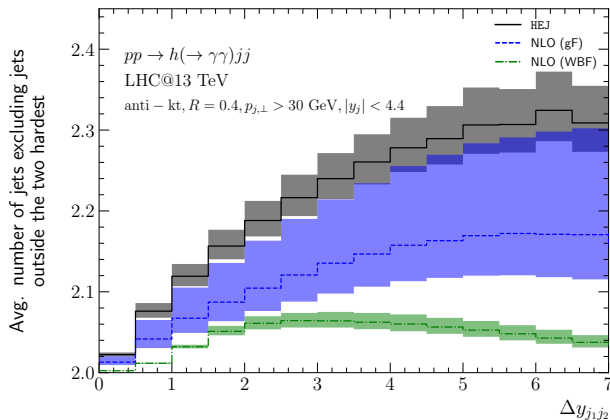

- gF : extra emissions inside rapidity gap \Rightarrow logarithmically enhanced

What is *High Energy Jets*?

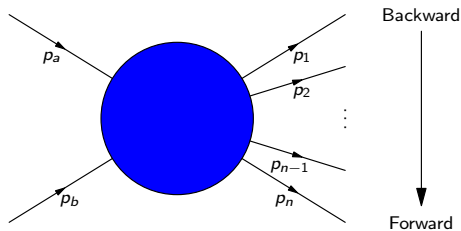

High Energy Limit: Large $\Delta y_{ij}, p_{i\perp} \sim p_{j\perp} \Leftrightarrow$ Large $s_{ij}, t_{ij} = \text{const. } \forall i, j$
 $\Rightarrow \mathcal{M}$ becomes independent of $y \Rightarrow \sigma \propto \Delta y$

Goal: Resumming large $\log s/t \sim \Delta y$

Approximation: Only on Matrix Element
 \Rightarrow Keep full phase space (MC integration)
 \Rightarrow Keep full quark-mass dependence for any multiplicity

Multi Regge theory (Brower DeTar, Weis '74 & Fadin, Fiore, Kozlov, Reznichenko '06)

For $s_{ij} \rightarrow \infty$ and $t_i = \text{const.}$, with α_i spin of exchange particle:

$$\mathcal{M} \sim s_{12}^{\alpha_1(t_1)} \dots s_{n-1,n}^{\alpha_{n-1}(t_{n-1})} \cdot \gamma(\{p_{i\perp}\}, \dots)$$

- **Gluon** exchange (FKL)
 - $\Rightarrow |\mathcal{M}|^2 \propto s_{j_1 j_2}^2 s_{j_2 H}^2 s_{j_3 H}^2$
- **Quark** exchange (unordered)
 - $\Rightarrow |\mathcal{M}|^2 \propto s_{j_1 j_2} s_{j_2 H}^2 s_{j_3 H}^2$
- **Higgs** outside quarks & uno
 - $\Rightarrow |\mathcal{M}|^2 \propto s_{j_1 H} s_{j_2 H} s_{j_2 j_3}^2$

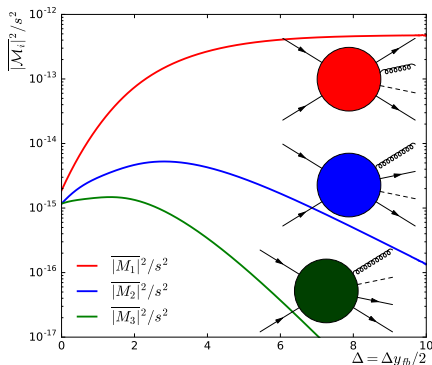

Multi Regge theory (Brower DeTar, Weis '74 & Fadin, Fiore, Kozlov, Reznichenko '06)

For $s_{ij} \rightarrow \infty$ and $t_i = \text{const.}$, with α_i spin of exchange particle:

$$\mathcal{M} \sim s_{12}^{\alpha_1(t_1)} \dots s_{n-1,n}^{\alpha_{n-1}(t_{n-1})} \cdot \gamma(\{p_{i\perp}\}, \dots)$$

- **Gluon** exchange (FKL)
 - $\Rightarrow |\mathcal{M}|^2 \propto s_{j_1 j_2}^2 s_{j_2 H}^2 s_{j_3 H}^2$
- **Quark** exchange (unordered)
 - $\Rightarrow |\mathcal{M}|^2 \propto s_{j_1 j_2} s_{j_2 H}^2 s_{j_3 H}^2$
- **Higgs** outside quarks & uno
 - $\Rightarrow |\mathcal{M}|^2 \propto s_{j_1 H} s_{j_2 H} s_{j_2 j_3}^2$

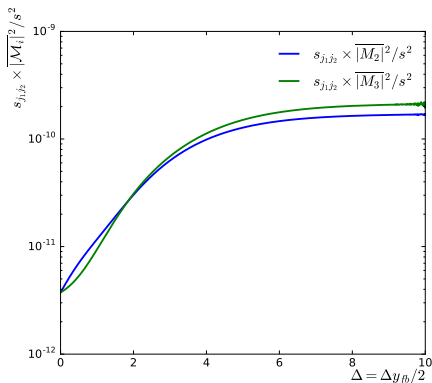

HEJ Matrix element

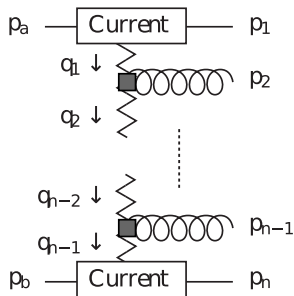

$$\begin{aligned}
 & \frac{1}{4(N_C^2 - 1)} \|S_{f_a f_b \rightarrow f_1 f_n}\|^2 \\
 & \cdot \left(g_s^2 K_{f_1} \frac{1}{t_1}\right) \cdot \left(g_s^2 K_{f_n} \frac{1}{t_{n-1}}\right) \\
 = & \cdot \prod_{i=1}^{n-2} \left(\frac{-g_s^2 C_A}{t_i t_{i+1}} V^\mu(q_i, q_{i+1}) V_\mu(q_i, q_{i+1})\right) \\
 & \cdot \prod_{j=1}^{n-1} \exp\left[\omega^0(q_{j\perp})(y_{j+1} - y_j)\right]
 \end{aligned}$$

Processes \Leftrightarrow currents, e.g. $S_{qQ \rightarrow qHQ} = j_\mu(p_1, p_a) V_H^{\mu\nu}(q_j, q_{j+1}) j_\nu(p_b, p_n)$.

arxiv:1706.01002

HEJ Matrix element

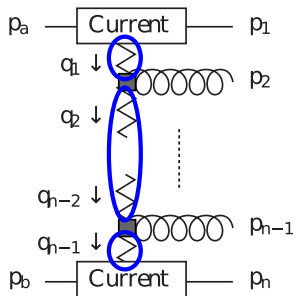

$$\begin{aligned}
 & \frac{1}{4(N_C^2 - 1)} \|S_{f_a f_b \rightarrow f_1 f_n}\|^2 \\
 & \cdot \left(g_s^2 K_{f_1} \frac{\mathbf{1}}{\mathbf{t}_1}\right) \cdot \left(g_s^2 K_{f_n} \frac{\mathbf{1}}{\mathbf{t}_{n-1}}\right) \\
 = & \cdot \prod_{i=1}^{n-2} \left(\frac{-g_s^2 C_A}{\mathbf{t}_i \mathbf{t}_{i+1}} V^\mu(q_i, q_{i+1}) V_\mu(q_i, q_{i+1})\right) \\
 & \cdot \prod_{j=1}^{n-1} \exp\left[\omega^0(\mathbf{q}_{j\perp})(\mathbf{y}_{j+1} - \mathbf{y}_j)\right]
 \end{aligned}$$

Processes \Leftrightarrow currents, e.g. $S_{qQ \rightarrow qHQ} = j_\mu(p_1, p_a) V_H^{\mu\nu}(q_j, q_{j+1}) j_\nu(p_b, p_n)$.

arxiv:1706.01002

HEJ Matrix element

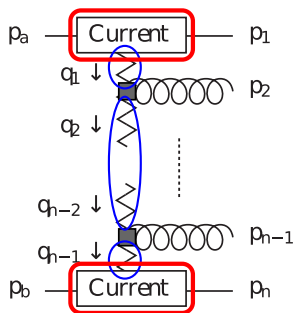

$$\begin{aligned}
 & \frac{1}{4(N_C^2 - 1)} \left\| S_{f_a f_b \rightarrow f_1 f_n} \right\|^2 \\
 & \cdot \left(g_s^2 K_{f_1} \frac{1}{t_1} \right) \cdot \left(g_s^2 K_{f_n} \frac{1}{t_{n-1}} \right) \\
 = & \cdot \prod_{i=1}^{n-2} \left(\frac{-g_s^2 C_A}{t_i t_{i+1}} V^\mu(q_i, q_{i+1}) V_\mu(q_i, q_{i+1}) \right) \\
 & \cdot \prod_{j=1}^{n-1} \exp \left[\omega^0(q_{j\perp})(y_{j+1} - y_j) \right]
 \end{aligned}$$

Processes \Leftrightarrow currents, e.g. $S_{qQ \rightarrow qHQ} = j_\mu(p_1, p_a) V_H^{\mu\nu}(q_j, q_{j+1}) j_\nu(p_b, p_n)$.

arxiv:1706.01002

HEJ Matrix element

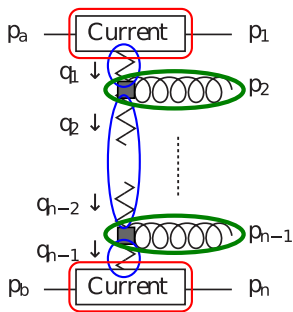

$$\begin{aligned}
 & \frac{1}{4(N_C^2 - 1)} \|S_{f_a f_b \rightarrow f_1 f_n}\|^2 \\
 & \cdot \left(g_s^2 K_{f_1} \frac{1}{t_1} \right) \cdot \left(g_s^2 K_{f_n} \frac{1}{t_{n-1}} \right) \\
 = & \prod_{i=1}^{n-2} \left(\frac{-g_s^2 C_A}{t_i t_{i+1}} \mathbf{V}^\mu(\mathbf{q}_i, \mathbf{q}_{i+1}) \mathbf{V}_\mu(\mathbf{q}_i, \mathbf{q}_{i+1}) \right) \\
 & \cdot \prod_{j=1}^{n-1} \exp \left[\omega^0(q_{j\perp})(y_{j+1} - y_j) \right]
 \end{aligned}$$

Processes \Leftrightarrow currents, e.g. $S_{qQ \rightarrow qHQ} = j_\mu(p_1, p_a) V_H^{\mu\nu}(q_j, q_{j+1}) j_\nu(p_b, p_n)$.

arxiv:1706.01002

HEJ Matrix element

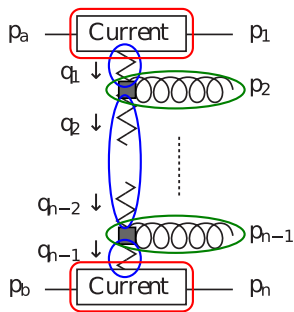

$$\begin{aligned}
 & \frac{1}{4(N_C^2 - 1)} \|S_{f_a f_b \rightarrow f_1 f_n}\|^2 \\
 & \cdot \left(g_s^2 K_{f_1} \frac{1}{t_1} \right) \cdot \left(g_s^2 K_{f_n} \frac{1}{t_{n-1}} \right) \\
 = & \cdot \prod_{i=1}^{n-2} \left(\frac{-g_s^2 C_A}{t_i t_{i+1}} V^\mu(q_i, q_{i+1}) V_\mu(q_i, q_{i+1}) \right) \\
 & \cdot \prod_{j=1}^{n-1} \exp \left[\omega^0(q_{j\perp})(y_{j+1} - y_j) \right]
 \end{aligned}$$

Processes \Leftrightarrow currents, e.g. $S_{qQ \rightarrow qHQ} = j_\mu(p_1, p_a) V_H^{\mu\nu}(q_j, q_{j+1}) j_\nu(p_b, p_n)$.

arxiv:1706.01002

Finite quark mass effects

Simplest case: $qQ \rightarrow qHQ$

Higgs coupling factorises:

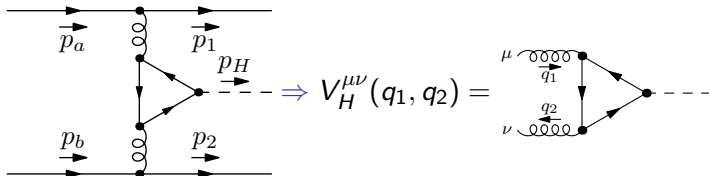

$$V_H^{\mu\nu}(q_i, q_{i+1}) = \frac{\alpha_s m^2}{\pi v} [g^{\mu\nu} T_1(q_i, q_{i+1}) - q_{i+1}^\mu q_i^\nu T_2(q_i, q_{i+1})]$$

$$\xrightarrow{m \rightarrow \infty} \frac{\alpha_s}{3\pi v} (g^{\mu\nu} q_i q_{i+1} - q_{i+1}^\mu q_i^\nu)$$

with form factors T_1 and T_2 .

Finite quark mass effects

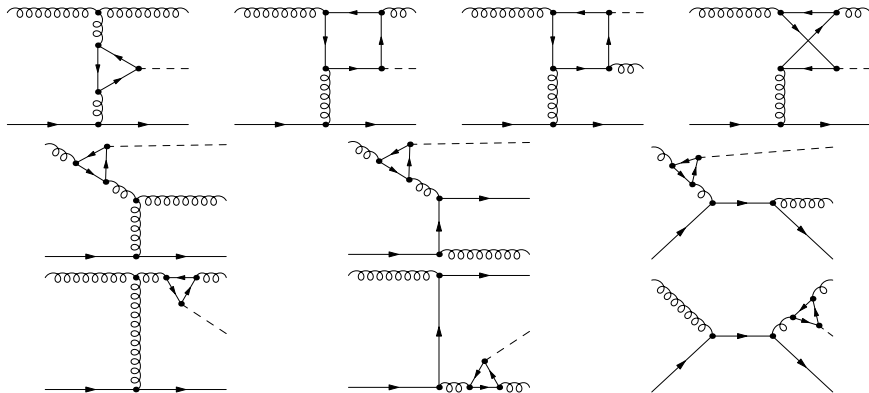

⇒ Rapidity ordering matters, e.g. Higgs boson outside or inside jets

Del Duca, Kilgore, Oleari, Schmidt, Zeppenfeld '03

Finite quark mass effects

Building pieces in HEJ (currents) [arxiv:1812.08072](https://arxiv.org/abs/1812.08072)

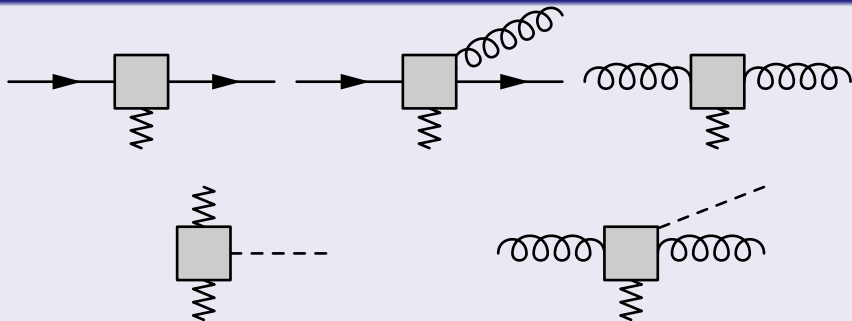

Del Duca, Kilgore, Oleari, Schmidt, Zeppenfeld '03

Sneak peak: W plus jets

Remaining NLL currents

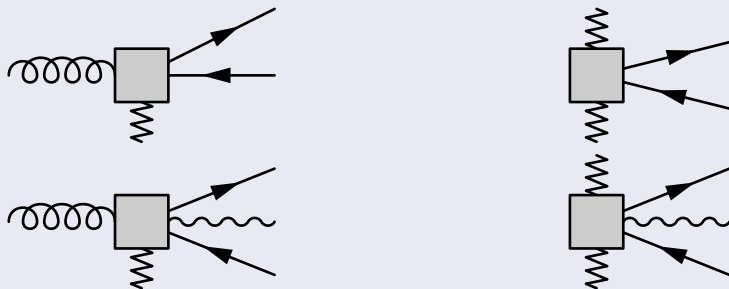

⇒ Implemented for W plus jets (arxiv:19XX)

→ Will be used for Higgs, pure jets, two W, ...

Matching with Fixed Order

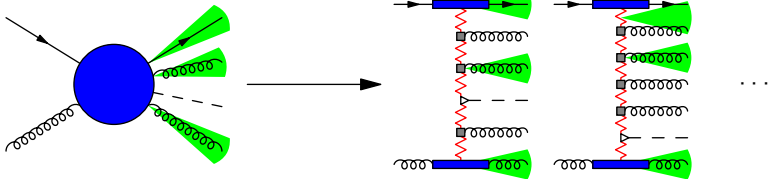

Fixed-order FKL event
MadGraph, Sherpa, ...
 $\sim |\mathcal{M}_{\text{LO}}|^2$

Resummation events
Keep Higgs + jet rapidities, shift jet p_{\perp}
 $\sim |\mathcal{M}_{\text{HEJ}}|^2$

$$\Rightarrow \text{Matrix Element weight} \propto |\mathcal{M}_{\text{HEJ}}|^2 \frac{|\mathcal{M}_{\text{LO}}|^2}{|\mathcal{M}_{\text{HEJ,LO}}|^2}$$

arxiv:1805.04446

Matching & merging with Fixed Order

$$\begin{aligned}
 \sigma_{2j}^{\text{resum,match}} = & \sum_{f_1, f_2} \sum_m \prod_{j=1}^m \left(\int_{p_{j\perp}^B=0}^{p_{j\perp}^B=\infty} \frac{d^2 \mathbf{p}_{j\perp}^B}{(2\pi)^3} \int \frac{dy_j^B}{2} \right) (2\pi)^4 \delta^{(2)} \left(\sum_{k=1}^m \mathbf{p}_{k\perp}^B \right) && \text{Fixed Order} \\
 & \cdot x_a^B f_a(x_a^B, Q_a^B) x_b^B f_b(x_b^B, Q_b^B) \frac{|\mathcal{M}^B|^2}{(\hat{s}^B)^2} \\
 & \cdot \overline{|\mathcal{M}_{\text{HEJ}}^{\text{tree}}|}^{-2} (2\pi)^{-4+3m} 2^m \frac{(\hat{s}^B)^2}{x_a^B f_{a,f_1}(x_a^B, Q_a^B) x_b^B f_{b,f_2}(x_b^B, Q_b^B)} && \text{Overlap HEJ} \\
 & \cdot \sum_{n=2}^{\infty} \int_{p_{1\perp}=\dots=p_{j\perp}}^{p_{1\perp}=\infty} \frac{d^2 \mathbf{p}_{1\perp}}{(2\pi)^3} \int_{p_{n\perp}=\dots=p_{j\perp}}^{p_{n\perp}=\infty} \frac{d^2 \mathbf{p}_{n\perp}}{(2\pi)^3} \prod_{i=2}^{n-1} \int_{p_{i\perp}=\lambda}^{p_{i\perp}=\infty} \frac{d^2 \mathbf{p}_{i\perp}}{(2\pi)^3} (2\pi)^4 \delta^{(2)} \left(\sum_{k=1}^n \mathbf{p}_{k\perp} \right) \\
 & \cdot \tau_y \prod_{i=1}^n \left(\int \frac{dy_i}{2} \right) \mathcal{O}_{mj}^e \left(\prod_{l=1}^{m-1} \delta^{(2)}(\mathbf{p}_{\mathcal{J}_l\perp} - \mathbf{j}_{l\perp}) \right) \left(\prod_{l=1}^m \delta(y_{\mathcal{J}_l} - y_{\mathcal{J}_l}) \right) \mathcal{O}_{2j}(\{p_i\}) \\
 & \cdot x_a f_{a,f_1}(x_a, Q_a) x_b f_{b,f_2}(x_b, Q_b) \frac{|\mathcal{M}_{\text{HEJ}}^{f_1 f_2 \rightarrow f_1 g \dots g f_2}(\{p_i\})|^2}{\hat{s}^2}.
 \end{aligned}$$

- Modular generation, independently of Fixed Order provider
- ⇒ computationally effective, merging *limited* by Fixed Order (~ 5 jets)

arxiv:1805.04446

Higgs p_{\perp}

finite m_b

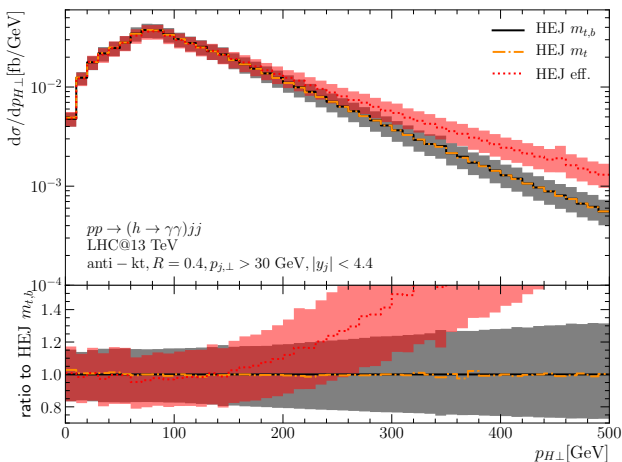

⇒ finite quark masses $\hat{=}$ - 50% at 350 GeV

⇒ no (visible) effect from finite m_b

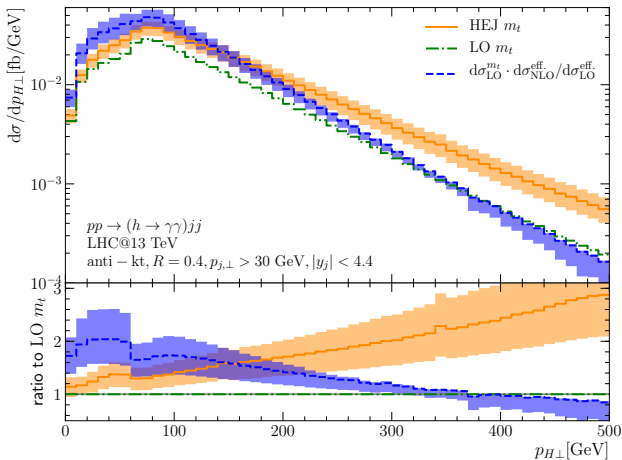

\Rightarrow HEJ harder in $p_{H\perp} \Rightarrow$ more sensitive to finite m_t effect

$\Rightarrow \sigma_{HEJ}^{eff} \sim 1.1 \times \sigma_{HEJ}^{m_t}$

Invariant jet mass

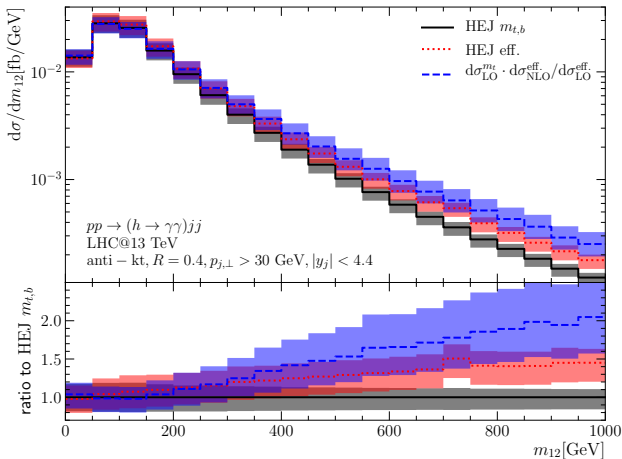

⇒ After VBF-cuts: $\sigma_{\text{HEJ}}^{m_t \rightarrow \infty} \approx 1.1 \cdot \sigma_{\text{HEJ}} \approx 0.5 \cdot \sigma_{\text{NLO}}$

⇒ Large difference between different theory calculations

Summary

- HEJ provides all-order resummation for large $\log(s/t) \sim \Delta y$
- ⇒ Only few building pieces for amplitudes
- ⇒ Flexible matching & merging
 - VBF cuts: rapidity separation & large invariant mass
- ⇒ Cross section with HEJ resummation 50% *smaller* compared to NLO
 - Finite top-mass
- ⇒ Larger effect in HEJ
- ⇒ Cross section $\sim -10\%$, strong p_{\perp} dependence
 - Public code, (library) documentation, docker, ...

<https://hej.web.cern.ch>

Backup slides

Test setup at LO

Higgs p_{\perp}

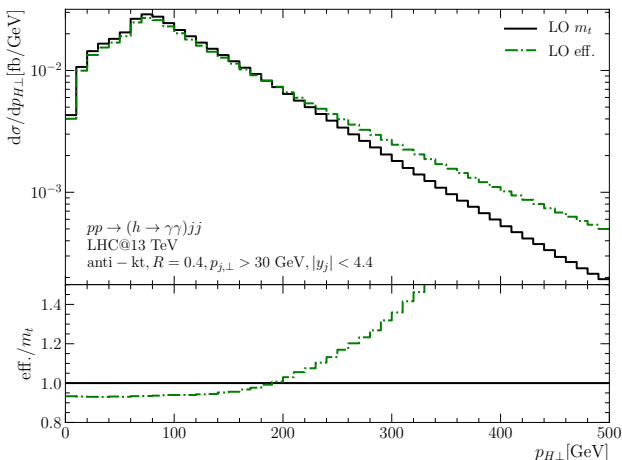

\Rightarrow LO $m_t \rightarrow \infty$: -5% at 0 GeV, $+50\%$ at 350 GeV

\Rightarrow "accidental" cancellation $\sigma_{FO}^{\text{eff}} \sim \sigma_{FO}^{m_t}$

Different scale choices

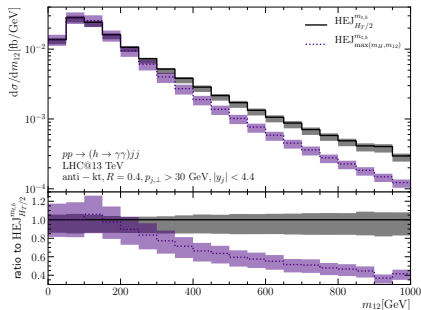
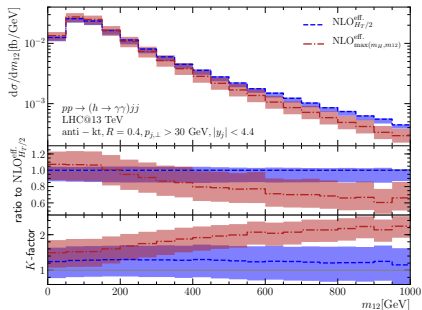

σ_{VBF}	$\mu = \max(m_H, m_{12})$	$\mu = H_T/2$	δ_μ
Fixed Order	$0.53^{+0.15}_{-0.13} \text{ fb}$	$0.82^{+0.02}_{-0.11} \text{ fb}$	+55%
HEJ	$0.23^{+0.02}_{-0.03} \text{ fb}$	$0.52^{+0.03}_{-0.08} \text{ fb}$	+26%
δ_{HEJ}	-57%	-36%	

Contributions from higher Jets

