

The Z path measurement – introduction for moderators

Magnar K. Bugge

University of Oslo

Moderators' orientation
February 20th 2020

Overview and goals

- The students go through events using event displays
 - Looking for good electron, muon, and photon candidates
 - Identifying events with dileptons ($e^+e^-/\mu^+\mu^-$), diphotons ($\gamma\gamma$), or 4 leptons ($e^+e^-e^+e^-$, $e^+e^-\mu^+\mu^-$, $\mu^+\mu^-\mu^+\mu^-$)
 - Calculating invariant masses and uploading these in the end to a plotting tool
- In the end, results are combined, and invariant mass distributions are built, where the students may have
 - Identified and measured masses(/widths) of well-known particles such as the J/ψ , Υ , and Z^0
 - Identified good Higgs-boson candidates
 - Discovered new particles (Z' , Graviton)

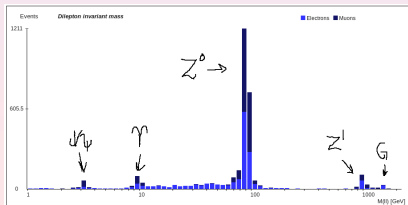

Physics background

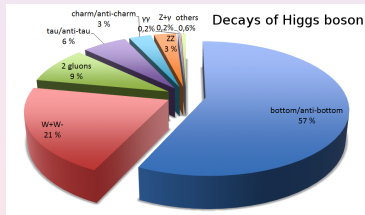
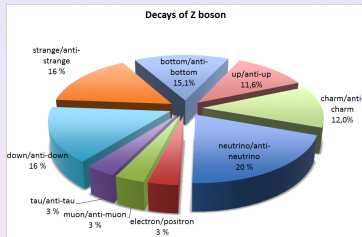
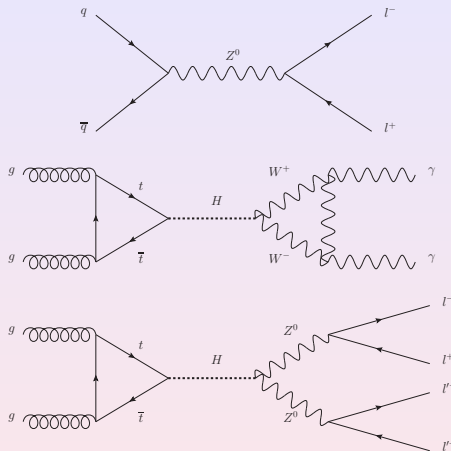

- Looking for rare decays (especially for Higgs) which are easily distinguishable from background

Identifying events in HYPATIA

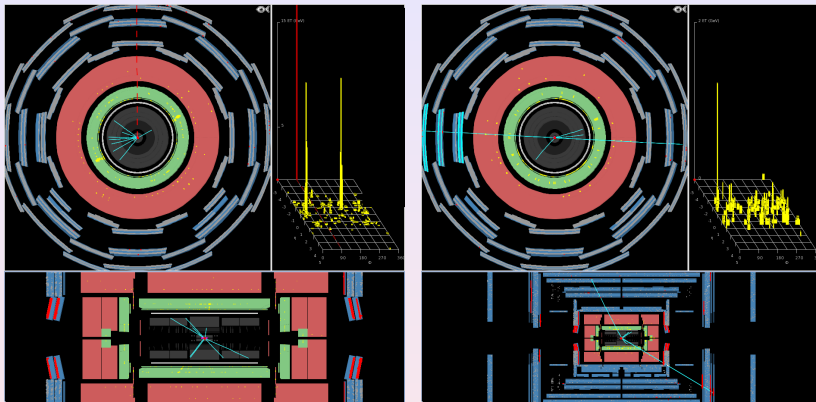

- Electron: concentrated energy deposit in EM calorimeter and associated track
- Muon: long track through whole detector

Identifying events in HYPATIA

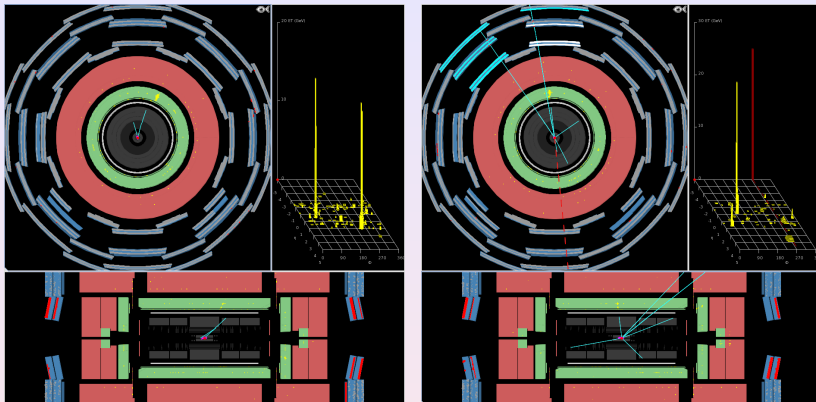

- Photon: electron-like EM energy deposit, but no track (unless converted)
- In all cases, students select objects which they identify as electron, muon, or photon, and HYPATIA calculates the corresponding invariant mass

The online plotting tool (OPlOT)

OPlOT – MasterClass – Combination Page

Start Student Moderator Tutor Administrator

Wednesday, February 22nd 2017 - 10:08:19 CET

Moderator Tasks

2016 ▾ March ▾ 09 ▾

- Institute combination
 - Oslo
 - Athens
 - Faro
 - Poznan
 - Katowice
- Combination plot - all institutes
- Slides comparing results from previous IMCs with official ATLAS Results

Groups that have uploaded their files:

Athens
Group 1J
Group 1O
Group 1P
Group 1D
Group 1I
Group 1J
Group 1K
Group 1L
Group 1P
-
..

- Click “Moderator” (no password required)
- Select date
- You can see which groups have uploaded their results
- Click “Combination plot – all institutes” to see combined results for all uploaded data on the given date

Z path results from 2016

OPlot – MasterClass – Combination for all institutes on 2016-03-09

Start Student Moderator Tutor Administrator

Monday, February 20th 2017 - 13:38:51 CET

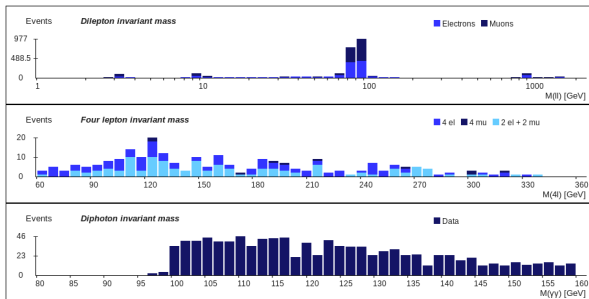

Bins:

Update plot

Reset

Plot type:

Dilepton statistics

Region	Electrons				
	R1	R2	R3	R4	R5
Events	104	122	768	76	31
Mean	3.14	9.77	89.86	999.46	1,496.29
Width	0.47	1.31	3.66	32.99	17.06

Region	Muons				
	R1	R2	R3	R4	R5
Events	73	90	874	65	14
Mean	3.07	9.97	90.46	997.90	1,479.29
Width	0.26	0.73	3.69	52.32	54.38

Number of events

Student distribution Expected	
ll	3118 4225
4l	347 40
yy	1092 1950
Sum	4557 6215

- “All institutes combination” start page
- Invariant mass distributions for all final states
- Table with estimated masses and widths
- Table with event counts compared to expectations

Z path results from 2016

OPlot – MasterClass – Combination for all institutes on 2016-03-09

Start Student Moderator Tutor Administrator

Monday, February 20th 2017 - 13:42:20 CET

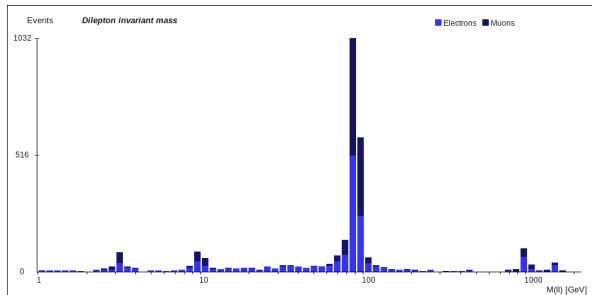

Bins:

X-Axis:

Upper:

Update plot

Reset

R1 Min:

R2 Min:

R3 Min:

R4 Min:

R5 Min:

R1 Max:

R2 Max:

R3 Max:

R4 Max:

R5 Max:

- Dilepton invariant mass distribution
- Can identify J/ψ , Υ , Z^0 , Z' , and graviton
- The latter two come as a surprise to the students (most likely already covered in the institute level review)



Z path results from 2016

OPlot – MasterClass – Combination for all institutes on 2016-03-09

Start Student Moderator Tutor Administrator

Monday, February 20th 2017 - 14:01:22 CET

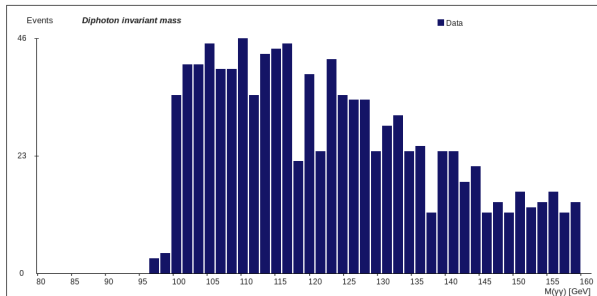

Plot type:

YY

Signal and background (simulated data):

- No data
- 0.3514 fb⁻¹
- 2 fb⁻¹
- 10 fb⁻¹
- 25 fb⁻¹

Analyzed data (real data):

- No data
- Student distribution
- Expected distribution

Diphoton statistics

Diphotons	
Region	R
Events	25
Mean	1,515.13
Width	38.91

Bins: 50

Lower: 80

Upper: 160

Update plot

Reset

R Min: 1400.0

R Max: 1600.0

- Diphoton invariant mass distribution
- In principle sensitive to Higgs contribution
- Statistics is too low to make a discovery

Z path results from 2016

OPlot – MasterClass – Combination for all institutes on 2016-03-09

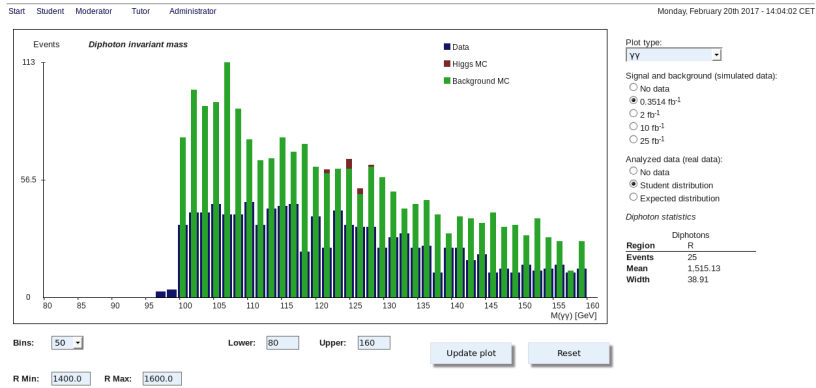

- Compare students' results to simulated background and signal corresponding to the analysed integrated luminosity

Z path results from 2016

OPlot – MasterClass – Combination for all institutes on 2016-03-09

Start Student Moderator Tutor Administrator

Monday, February 20th 2017 - 14:05:35 CET

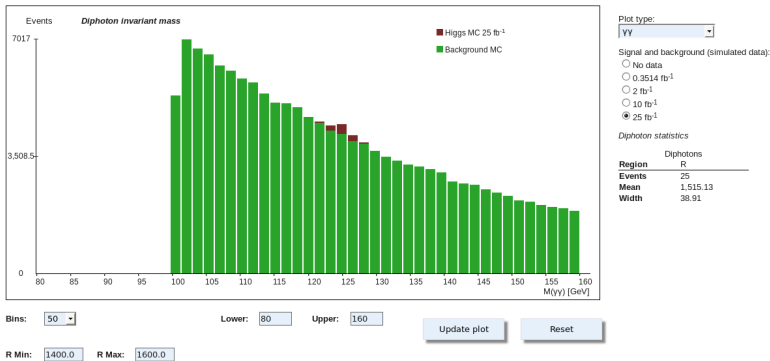

- Look at simulated background and signal for larger amounts of integrated luminosity
- ⇒ we could have seen the Higgs, we just need more data...

Z path results from 2016

OPlot – MasterClass – Combination for all institutes on 2016-03-09

Start Student Moderator Tutor Administrator

Monday, February 20th 2017 - 14:06:37 CET

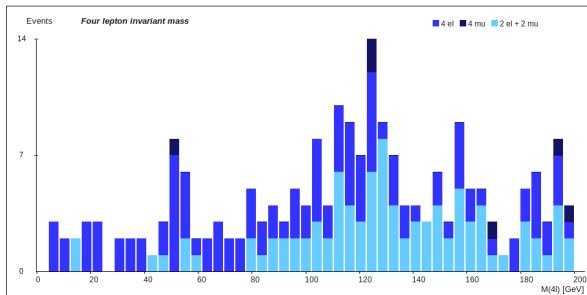

Plot type:

4l

Higgs simulated data:

2 fb $^{-1}$

10 fb $^{-1}$

25 fb $^{-1}$

Analyzed data (real data):

No data

Student distribution

Expected distribution

4-lepton statistics

Region	R			
Event type	4l	4e	4m	2e+2m
Events	19	6	7	6
Mean	1,488.24	1,512.22	1,471.38	1,483.5
Width	44.86	43.31	40.18	41.08

Bins: 50

Lower: 0

Upper: 200

Update plot

Reset

R Min: 1400.0

R Max: 1600.0

- 4-lepton invariant mass distribution
- Huge number of events (remember table in overview page)
- Notice composition in terms of $4e$, $2e2\mu$, 4μ
- Much easier to find fake electrons

Z path results from 2016

OPlot – MasterClass – Combination for all institutes on 2016-03-09

Start Student Moderator Tutor Administrator

Monday, February 20th 2017 - 14:14:08 CET

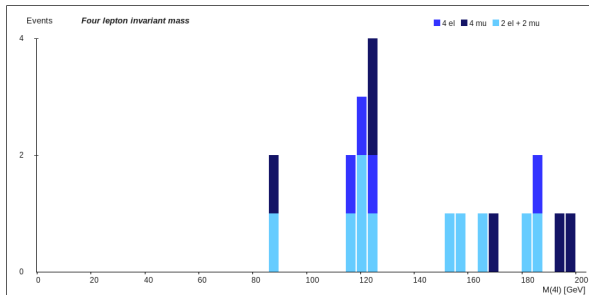

Plot type:

4l

Higgs simulated data:

- 2 fb⁻¹
 10 fb⁻¹
 25 fb⁻¹

Analyzed data (real data):

- No data
 Student distribution
 Expected distribution

4-lepton statistics

Region	R			
Event type	4l	4e	4m	2e+2m
Events	19	6	7	6
Mean	1,489.24	1,512.22	1,471.38	1,483.5
Width	44.86	43.31	40.18	41.08

Bins: 50

Lower: 0

Upper: 200

Update plot

Reset

R Min: 1400.0 R Max: 1600.0

- Expected distribution shows what the students would find with “perfect event identification”
- A few nice Higgs candidates with very little background
- Many participating students looked at these prime candidates during the day!

Moderator “scenarios”

OPlot – MasterClass – Combination for all institutes on 2016-03-09

Start Student Moderator Tutor Administrator

Monday, February 20th 2017 - 13:42:20 CET

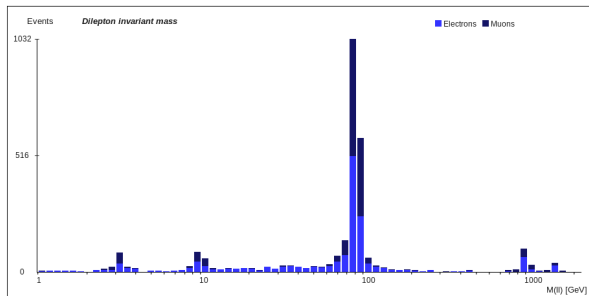

Plot type:

||

Dilepton statistics

Region	Electrons				
	R1	R2	R3	R4	R5
Events	104	122	768	76	31
Mean	3.14	9.77	89.86	999.46	1,496.29
Width	0.47	1.31	3.66	32.99	17.06

Region	Muons				
	R1	R2	R3	R4	R5
Events	73	90	874	65	14
Mean	3.07	9.97	90.46	997.90	1,479.29
Width	0.26	0.73	3.69	52.32	54.38

Bins: 70

X-Axis: Logarithmic

Upper: 2000

Update plot

Reset

R1 Min: 2.0 R2 Min: 7.0 R3 Min: 80.0 R4 Min: 900.0 R5 Min: 1400.0

R1 Max: 4.0 R2 Max: 13.0 R3 Max: 100.0 R4 Max: 1100.0 R5 Max: 1600.0

- 1 What does it mean when we see a peak in the distribution? Do you see any peaks that you did not expect?

Moderator “scenarios”

OPlot – MasterClass – Combination for all institutes on 2016-03-09

Start Student Moderator Tutor Administrator

Monday, February 20th 2017 - 14:01:22 CET

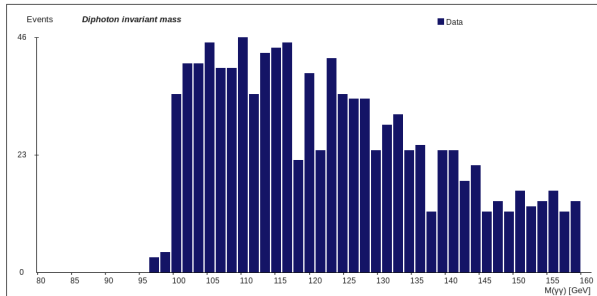

Plot type:

YY

Signal and background (simulated data):

- No data
- 0.3514 fb⁻¹
- 2 fb⁻¹
- 10 fb⁻¹
- 25 fb⁻¹

Analyzed data (real data):

- No data
- Student distribution
- Expected distribution

Diphoton statistics

Region	Diphotons	
	R	
Events	25	
Mean	1,515.13	
Width	38.91	

Bins: 50

Lower: 80

Upper: 160

Update plot

Reset

R Min: 1400.0

R Max: 1600.0

- 2 Do you see a peak corresponding to the Higgs boson? Why not?

Moderator “scenarios”

OPlot – MasterClass – Combination for all institutes on 2016-03-09

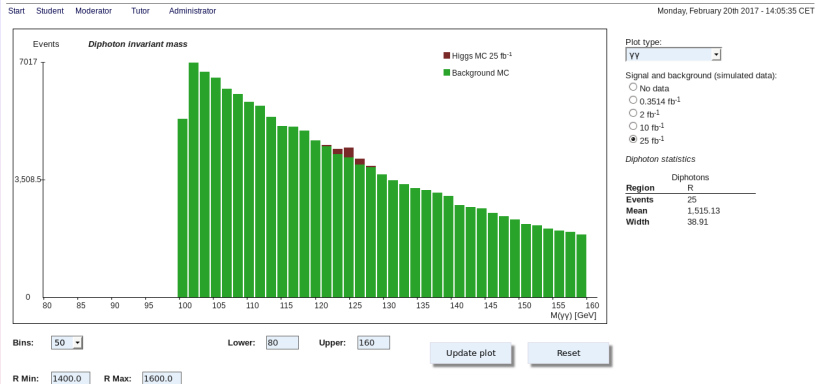

- 3 Do you think we could see the peak here even if it had the same color as the background? Why does it help to collect more data?

Moderator “scenarios”

OPlot – MasterClass – Combination for all institutes on 2016-03-09

Start Student Moderator Tutor Administrator

Monday, February 20th 2017 - 14:06:37 CET

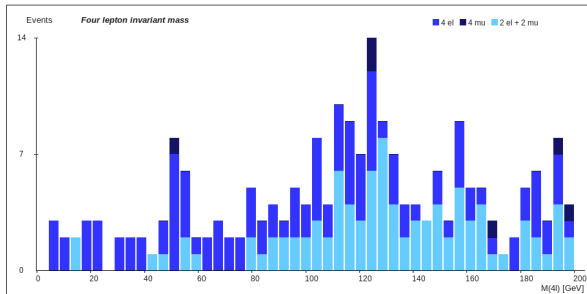

Plot type:

4l

Higgs simulated data:

- 2 fb⁻¹
- 10 fb⁻¹
- 25 fb⁻¹

Analyzed data (real data):

- No data
- Student distribution
- Expected distribution

4-lepton statistics

Region	R			
Event type	4l	4e	4m	2e+2m
Events	19	6	7	6
Mean	1,488.24	1,512.22	1,471.38	1,483.4
Width	44.86	43.31	40.18	41.08

Bins: 50

Lower: 0

Upper: 200

Update plot

Reset

R Min: 1400.0

R Max: 1600.0

- 4 Why are there many more 4-lepton events than expected? (Compare to table in summary or to expected distribution.) What can you say about the composition in terms of $4e$, $2e2\mu$, and 4μ ?

Moderator “scenarios”

OPlot – MasterClass – Combination for all institutes on 2016-03-09

Start Student Moderator Tutor Administrator

Sort by from

Monday, February 20th 2017 - 14:22:32 CET

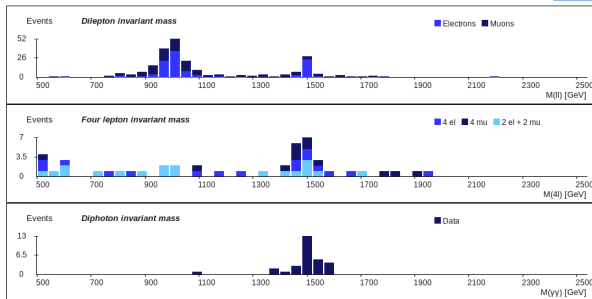

Plot type:

ll+4l+yy

Dilepton statistics

Region	Electrons				
	R1	R2	R3	R4	R5
Events	104	122	768	76	31
Mean	3.14	9.77	89.86	999.46	1,496.29
Width	0.47	1.31	3.66	32.99	17.06

Region	Muons				
	R1	R2	R3	R4	R5
Events	73	90	874	65	14
Mean	3.07	9.97	90.46	997.90	1,479.29
Width	0.26	0.73	3.69	52.32	54.38

Number of events

Student distribution		Expected
ll	3118	4225
4l	347	40
yy	1092	1950
Sum	4557	6215

Bins: 50

Lower: 500

Upper: 2500

Update plot

Reset

- 5 What does it tell us that the particle at 1000 GeV is not seen in the 4-lepton and diphoton distributions, while the particle at 1500 GeV is seen in all distributions?

- Students look for dilepton, diphoton, and 4-lepton events to search for
 - $Z^0 \rightarrow l^+l^-$ (and other dilepton resonances)
 - $H \rightarrow \gamma\gamma$ (and other diphoton resonances)
 - $H \rightarrow l^+l^-l'^+l'^-$ (and other 4-lepton resonances)
- Invariant masses are calculated in HYPATIA and uploaded to OPlot
- Invariant mass distributions are built for the combination of all students' data, showing resonance peaks corresponding to known and new particles
- 5 “scenarios” are provided as suggestions to guide the discussion with the students in the video conference