

QPix: Achieving kiloton scale pixelated readout for Liquid Argon Time Projection Chambers

Jonathan Asaadi
University of Texas at Arlington



Introduction

- **Neutrinos are among a handful of known fundamental particles**
 - The most abundant massive particle in the universe (They are everywhere!)
- **Despite their abundance, they are very difficult to detect**
 - Only interact via the weak nuclear force (which turns out to be very weak)
- **Neutrinos also change their flavor while propagating**
 - The simplest explanation is that neutrinos have distinct mass and mix

The Particle Universe

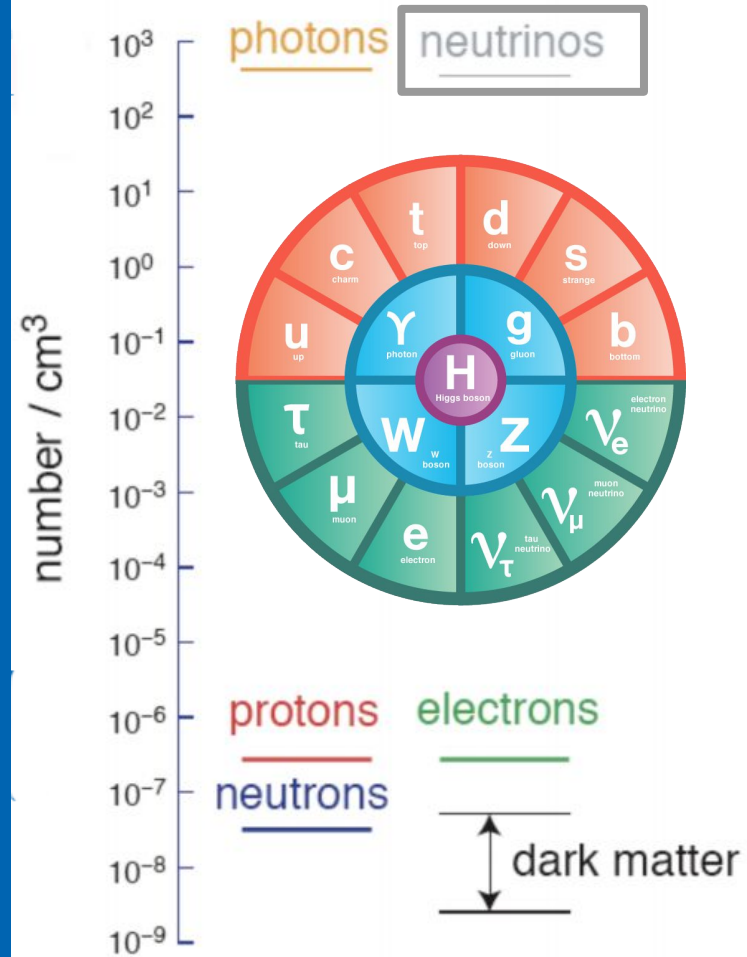

Neutrino Oscillation Physics

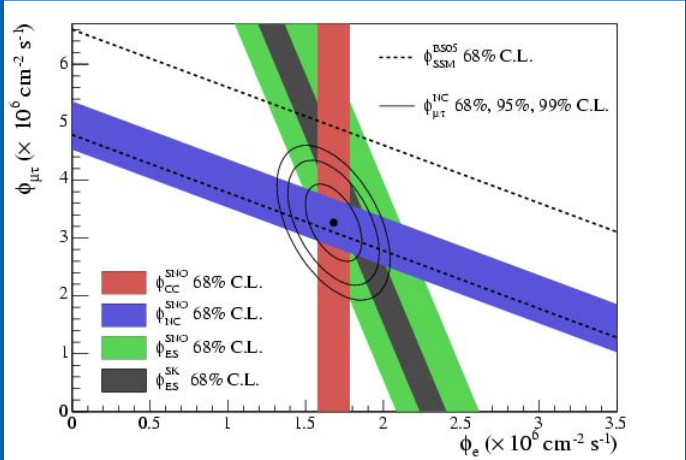
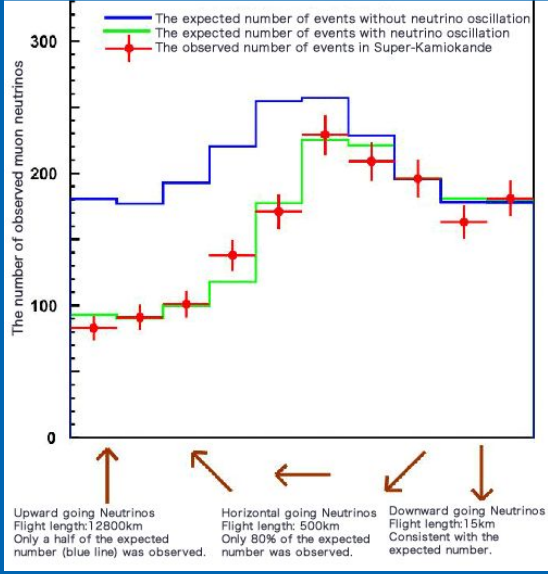

Solar Neutrinos

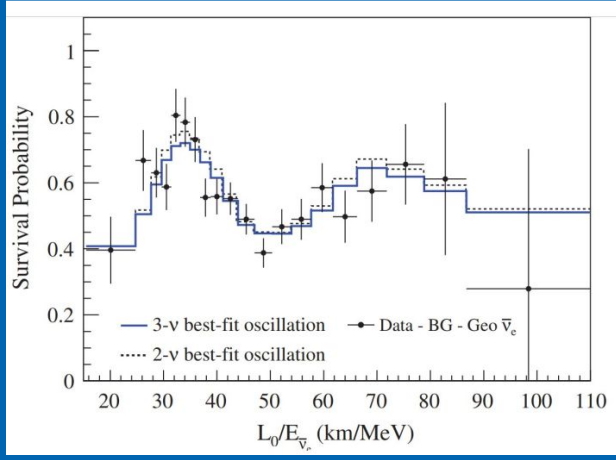

Reactor Neutrinos

Atmospheric Neutrinos

- The phenomenon of neutrino oscillations is now decidedly established across multiple experimental probes

Neutrino Oscillation Physics

$$\begin{pmatrix} \nu_e \\ \nu_\mu \\ \nu_\tau \end{pmatrix} = \begin{pmatrix} U_{e1}^* & U_{\mu 1}^* & U_{\tau 1}^* \\ U_{e2}^* & U_{\mu 2}^* & U_{\tau 2}^* \\ U_{e3}^* & U_{\mu 3}^* & U_{\tau 3}^* \end{pmatrix} \begin{pmatrix} \nu_1 \\ \nu_2 \\ \nu_3 \end{pmatrix}$$

$$|\nu_f\rangle = \sum_{i=1}^N U_{fi}^* e^{-iE_i t} |\nu_i\rangle$$

$$(E_i - E_j)t = \frac{m_i^2 - m_j^2 L}{2E} = \frac{\Delta m_{ij}^2 L}{2E}$$

- Neutrino oscillations can be understood by relating the flavor states to the mass states via a unitary mixing matrix
- The time evolution of the states can be characterized in terms of mass difference, distance of propagation, and energy

$$\begin{pmatrix} \nu_e \\ \nu_\mu \\ \nu_\tau \end{pmatrix} = \begin{pmatrix} U_{e1}^* & U_{\mu 1}^* & U_{\tau 1}^* \\ U_{e2}^* & U_{\mu 2}^* & U_{\tau 2}^* \\ U_{e3}^* & U_{\mu 3}^* & U_{\tau 3}^* \end{pmatrix} \begin{pmatrix} \nu_1 \\ \nu_2 \\ \nu_3 \end{pmatrix}$$

$$(E_i - E_j)t = \frac{m_i^2 - m_j^2 L}{2E} = \frac{\Delta m_{ij}^2 L}{2E}$$

$$|\nu_f\rangle = \sum_{i=1}^N U_{fi}^* e^{-iE_i t} |\nu_i\rangle$$

$$U = \begin{pmatrix} 1 & 0 & 0 \\ 0 & c_{23} & s_{23} \\ 0 & -s_{23} & c_{23} \end{pmatrix} \times \begin{pmatrix} c_{13} & 0 & s_{13} e^{-i\delta} \\ 0 & 1 & 0 \\ -s_{13} e^{-i\delta} & 0 & c_{13} \end{pmatrix} \times \begin{pmatrix} c_{12} & s_{12} & 0 \\ -s_{12} & c_{12} & 0 \\ 0 & 0 & 1 \end{pmatrix} \times \begin{pmatrix} e^{i\alpha_1/2} & 0 & 0 \\ 0 & e^{i\alpha_2/2} & 0 \\ 0 & 0 & 1 \end{pmatrix}$$

Atmospheric & Accelerator Neutrinos

$L/E \sim 500 \text{ km/GeV}$

Use a combination to measure these

Solar & Reactor Neutrinos

$L/E \sim 1500 \text{ km/GeV}$

$$c_{ij} = \cos(\theta_{ij})$$

$$s_{ij} = \sin(\theta_{ij})$$

$\delta = \text{CP phase}$

$\alpha_i = \text{Majorana Phase}$

The mixing is described by three masses (m_1, m_2, m_3), three mixing angles ($\theta_{23}, \theta_{12}, \theta_{13}$), a CP-phase (δ), and two Majorana phases (α_1, α_2)

Neutrino Oscillation Physics

- Currently we have measurements of the three mixing angles ($\theta_{12} \sim 34^\circ$, $\theta_{13} \sim 9^\circ$, $\theta_{23} \sim 45^\circ$), two mass splittings ($\Delta m_{21} \sim 7.4 \times 10^{-5}$ eV, $\Delta m_{31} \sim 2.5 \times 10^{-3}$ eV)
- However, there is much left unknown for neutrino oscillations
 - CP-Violation ?
 - Mass Ordering ?
 - Octant of θ_{23} ?
- And many questions precision neutrino oscillation measurements can tell us
 - Supernova Dynamics
 - Origin of matter/anti-matter asymmetry

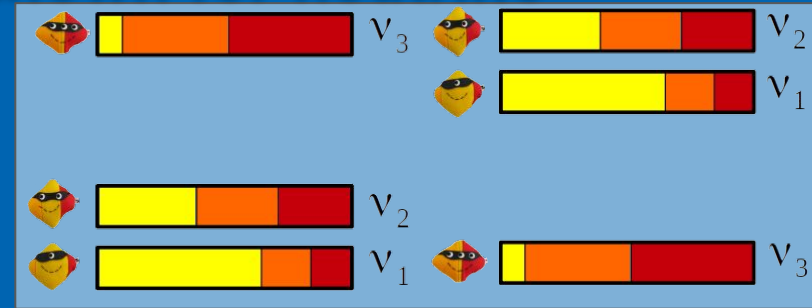

Neutrino Oscillation Physics

In order to answer these questions, next generation neutrino experiments will require that detectors are:

1. **Big/Scalable**

Put a large number of nuclei in the path of the neutrino

2. **Sensitive Charge and Light**

We want to collect information about the charged particles produced

3. **High Resolution**

We want to collect as much information about what took place during the neutrino interaction to understand the physics

Noble liquid detectors are a good candidate for use in neutrino detectors because they have many of these attractive properties

Liquid Argon Time Projection Chamber



	He	Ne	Ar	Kr	Xe	Water
Boiling Point [K] @ 1atm	4.2	27.1	87.3	120.0	165.0	373
Density [g/cm ³]	0.125	1.2	1.4	2.4	3.0	1
Radiation Length [cm]	755.2	24.0	14.0	4.9	2.8	36.1
dE/dx [MeV/cm]	0.24	1.4	2.1	3.0	3.8	1.9
Scintillation [γ /MeV]	19,000	30,000	40,000	25,000	42,000	
Scintillation λ [nm]	80	78	128	150	175	

- **Dense**
40% more dense than water
- **Abundant**
1% of the atmosphere
- **Ionizes easily**
55,000 electrons / cm
- **High electron lifetime**
Greek name means "inactive"
- **Produces copious scintillation light**
Transparent to light produced

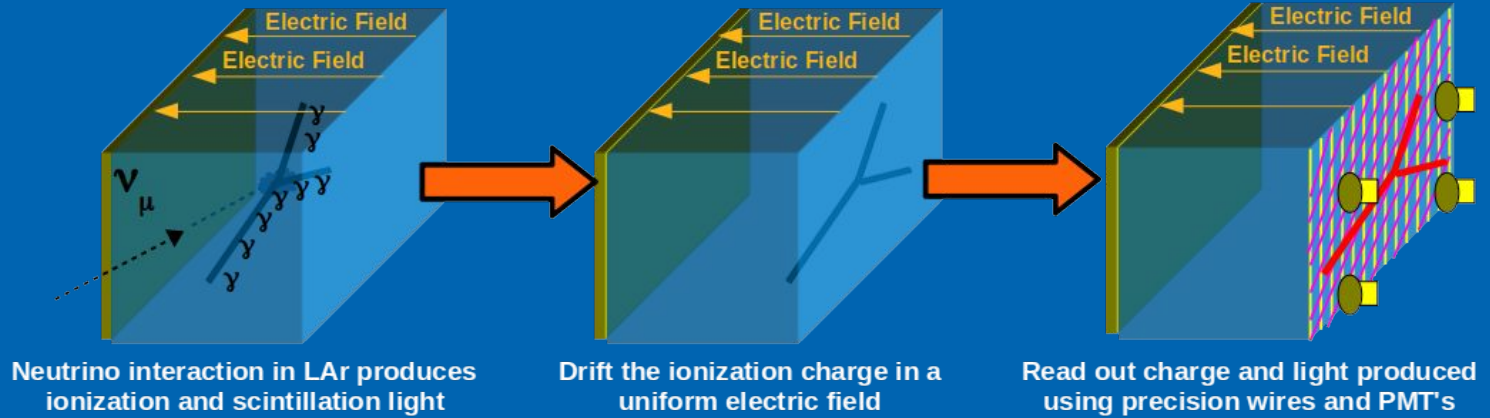

Deep Underground Neutrino Experiment (DUNE)

DUNE will be the premier long baseline neutrino experiment

- Multi-megawatt, high intensity, wide band neutrino beam produced at Fermilab directed towards the Sanford Underground Research Facility
- 40 kT (fiducial mass) LArTPC far detector
 - Four 10kT modules located at the 4850 level
- Highly capable neutrino near detector
 - Capable of fully characterize the spectrum and flavor composition of the beam

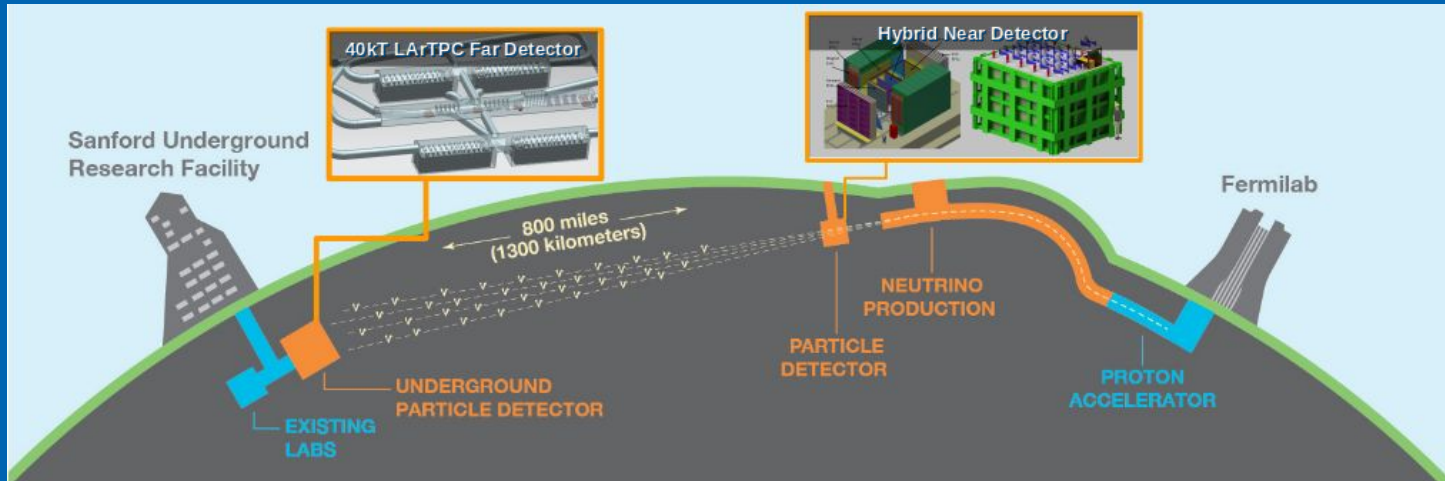

Introduction

- Liquid Argon Time Projection Chambers (LArTPC's) offer access to very high quality and detailed information

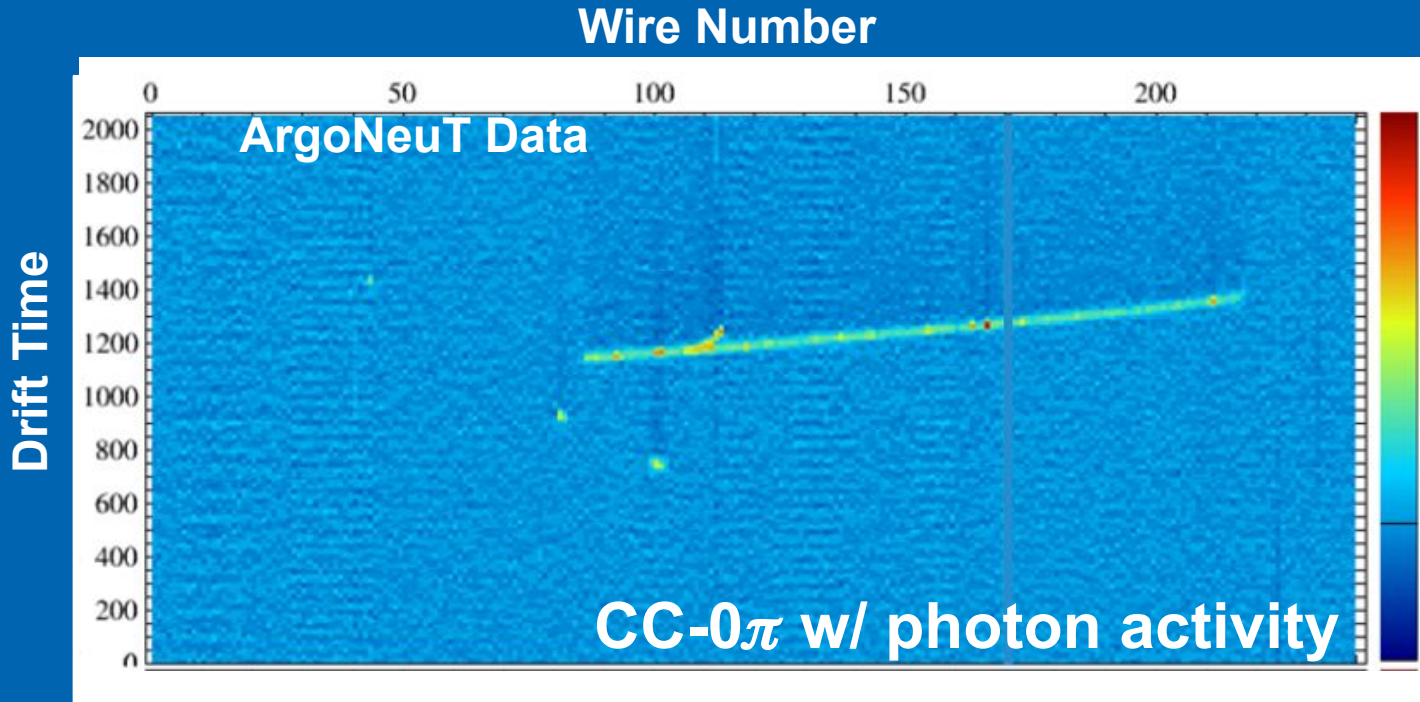

Introduction

- Leveraging this information allows unprecedented access to neutrino interaction specifics from MeV - GeV scales

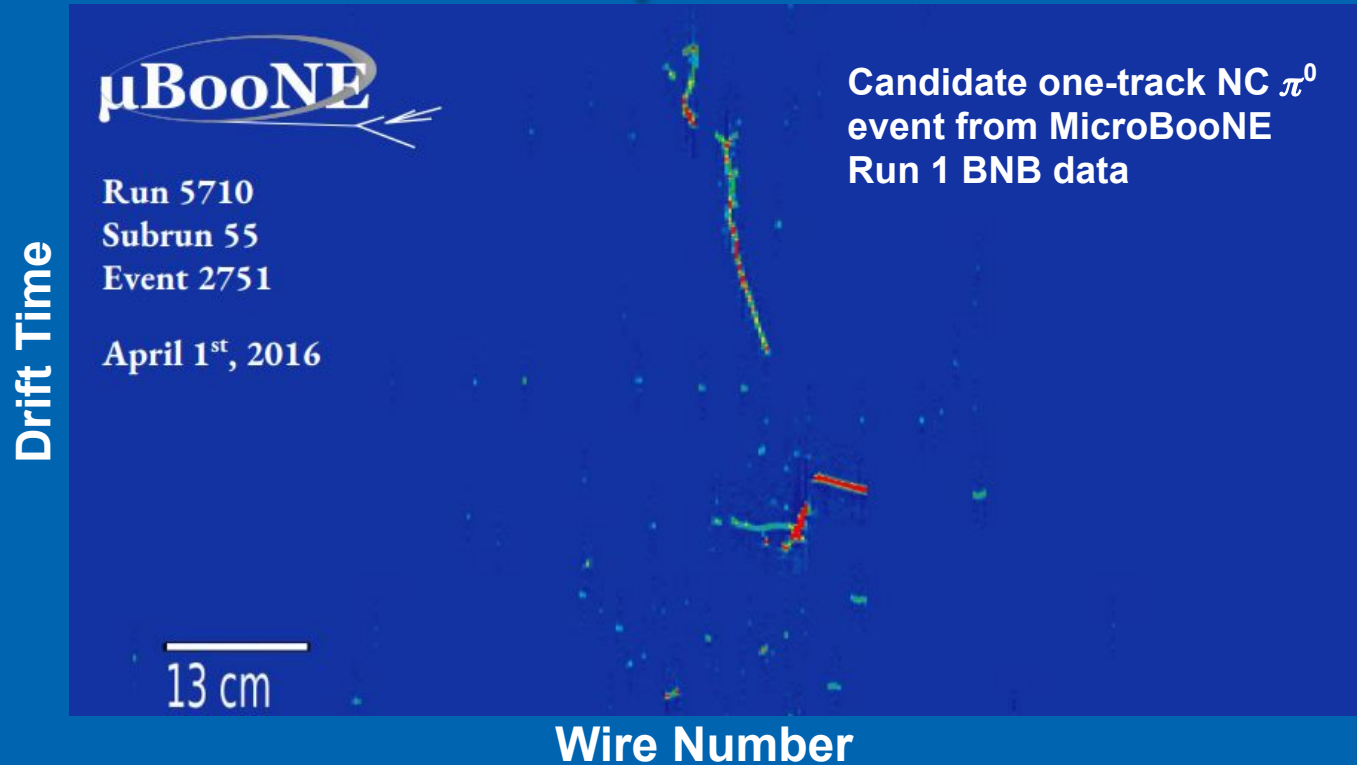

Introduction

- Capturing this data w/o compromise and maintaining the intrinsic 3-D quality is an essential component of all LArTPC readouts!

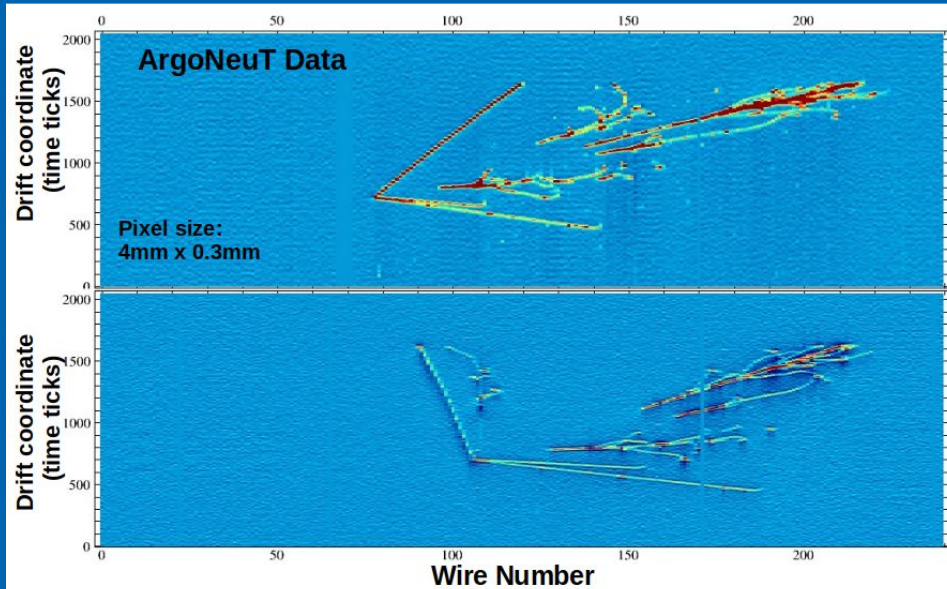

2D-Projective Readout

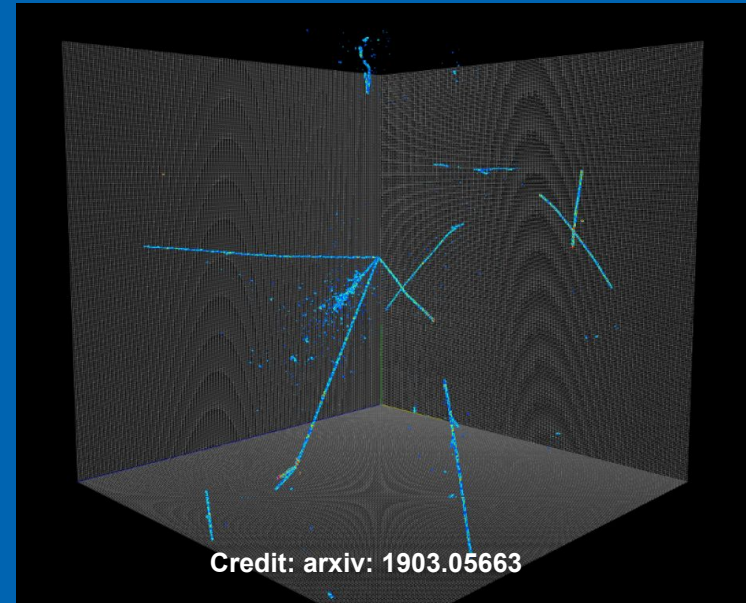

3D-Pixel Readout

Introduction

- Conventional LArTPC's use sets of wire planes at different orientations to reconstruct the 3D image
 - Challenge in reconstruction of complex topologies

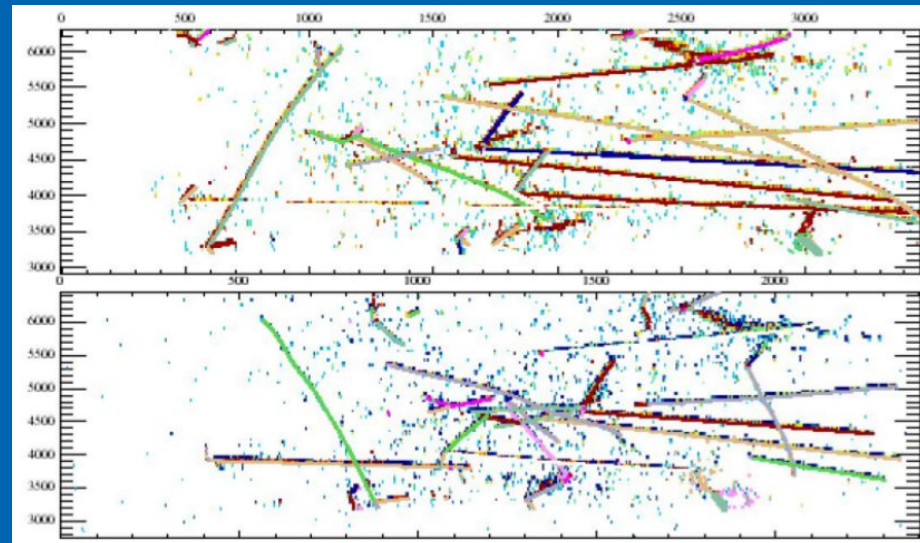
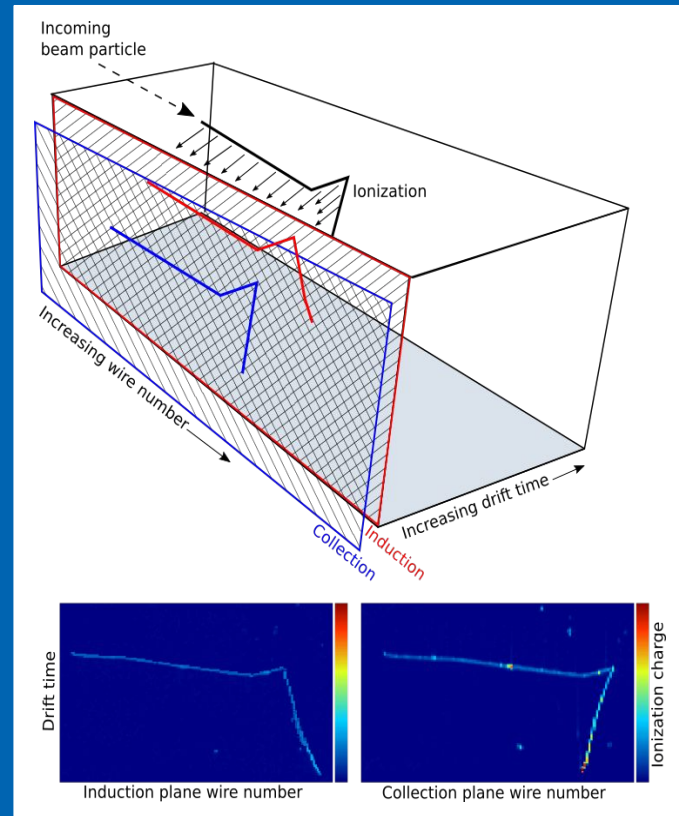

Introduction

Intrinsic reconstruction pathologies associated with charge deposited along the direction of the wires

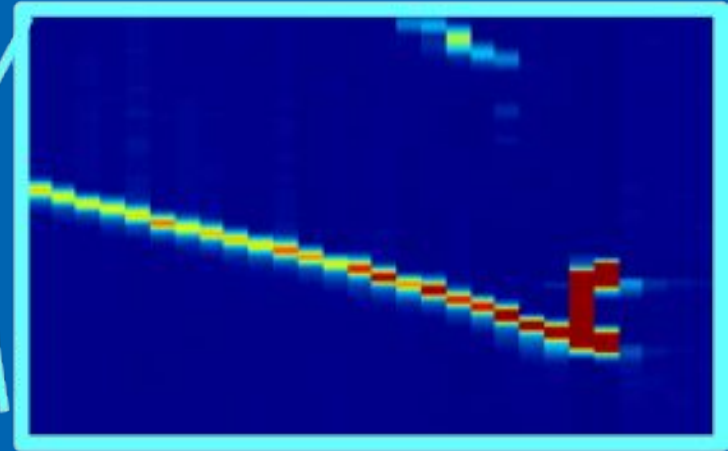
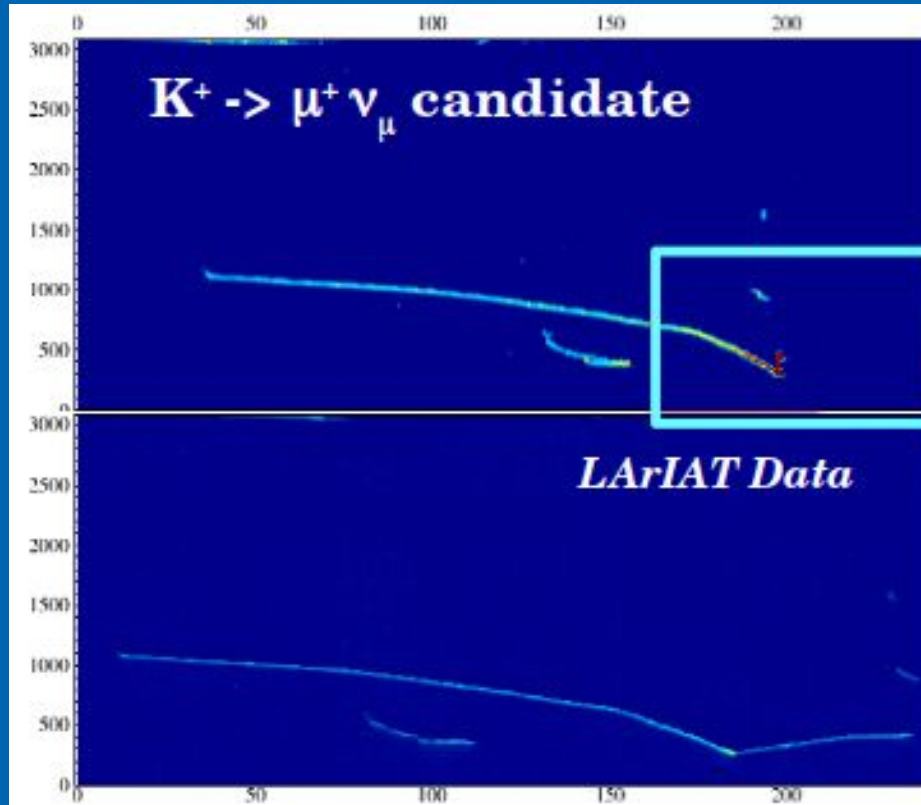

Introduction

- kiloTon scale LArTPC's use “wrapped wire” geometries to reduce the number of readout channels
 - Challenging to engineer such massive structures
 - Possible ambiguities associated with the readout increase with the wrapped geometry
 - Wire failure poses risk to loss of readout of an entire APA
 - Requires extensive (expensive) QA/QC
- The number of events in the DUNE far detector are few and precious
 - Don't want to lose any to readout/reconstruction

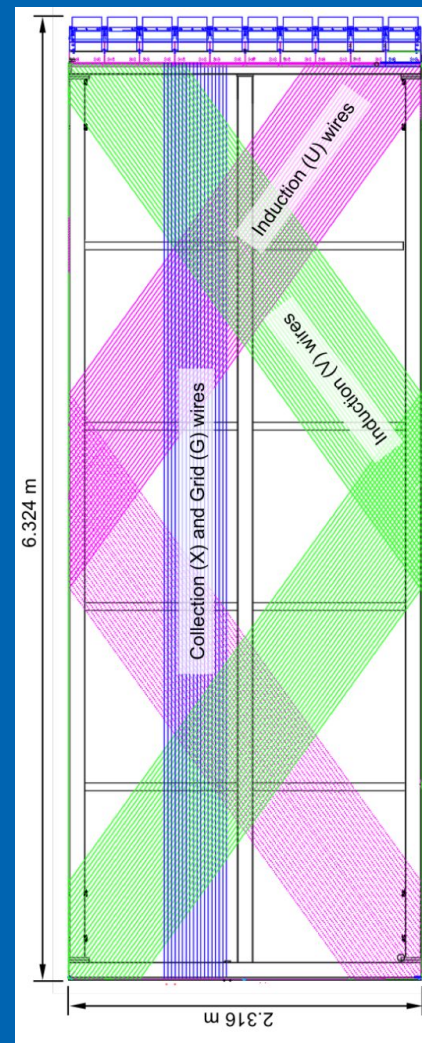

Introduction

- Readout of a LArTPC using pixels instead of wires can solve the shortcomings of projective wire readout
 - Comes at a “cost” of many more channels!
 - Example: 2 meter x 2 meter readout
 - 3mm wire pitch w/ three planes = 2450 channels
 - 3mm pixel pitch = 422,000 channels
 - Requires innovation in readout electronics to meet the heatload restrictions for the increase in readout channels!
 - Requires an “unorthodox” solution

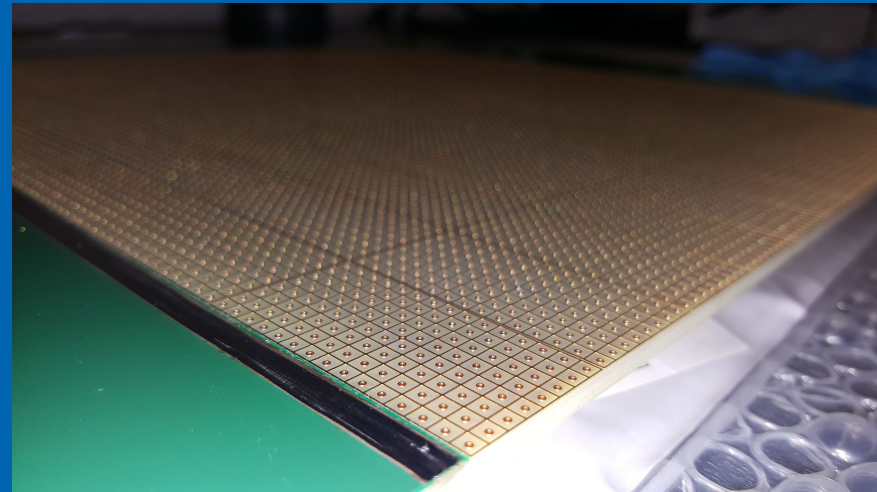

Introduction

- Kiloton scale LArTPCs (such as DUNE) afford a huge “big data” challenge to extract all the details offered by LArTPC
 - 1 second of DUNE full stream data ~4.6 TB (for 1.5 million channels)
 - 1 year of full stream data ~ 145 EB (exabytes)
- However, most of the time there is “nothing of interest” going on in the detector
 - But you must be ready “instantly” when something happens (proton decay, supernova, beam event, etc...)

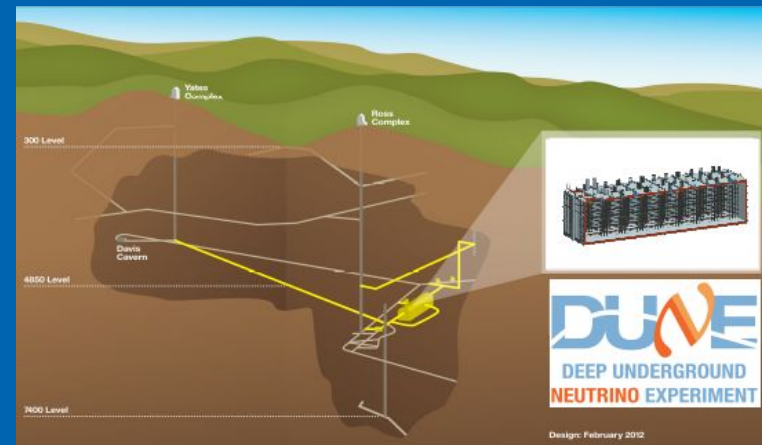
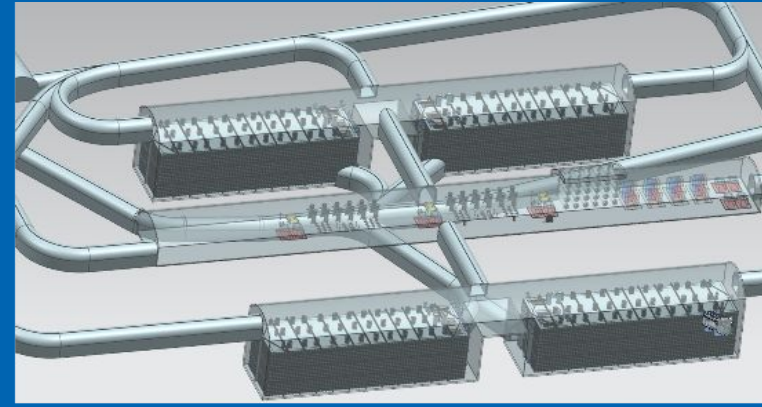

Introduction

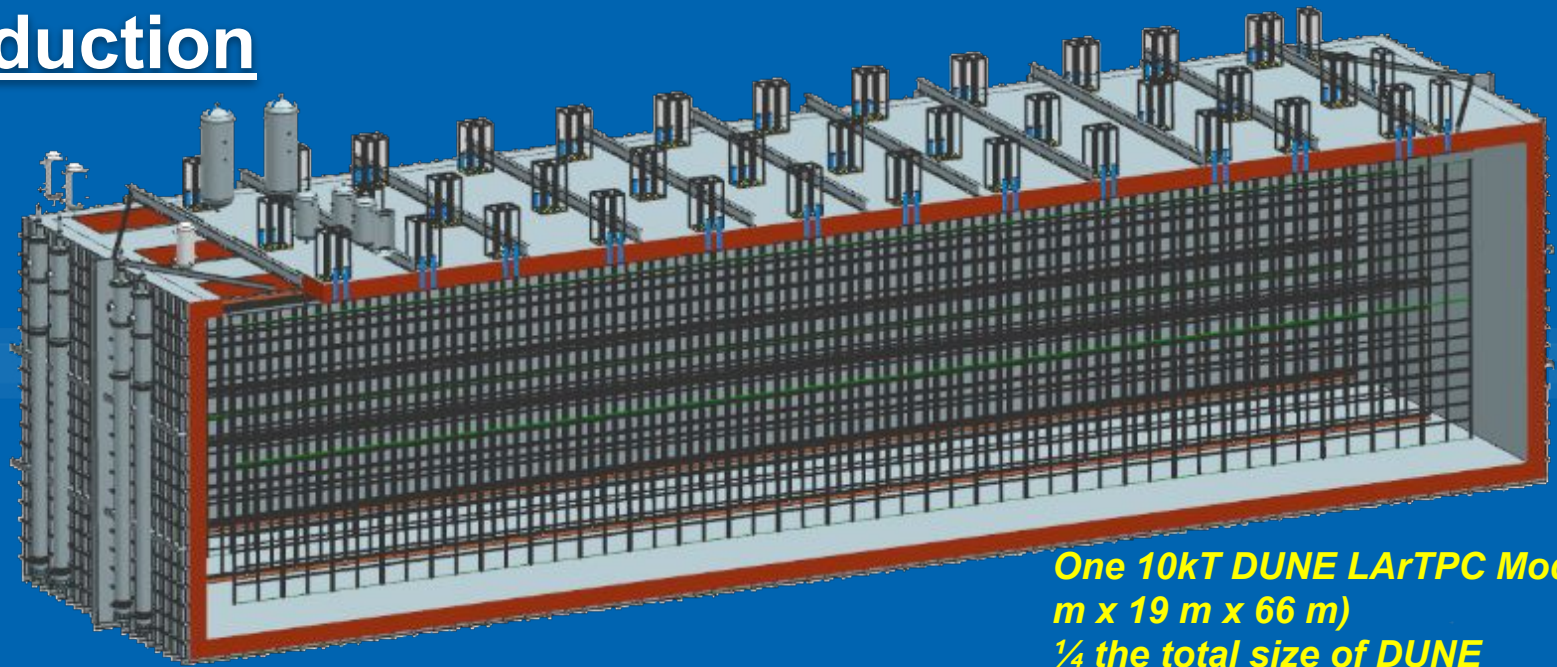

*One 10kT DUNE LArTPC Module (18 m x 19 m x 66 m)
¼ the total size of DUNE*

- To readout such massive detectors with pixels requires an enormous number of channels
 - \mathcal{O} (130 million) per 10 kTon at 4mm pitch
 - **Requires an “unorthodox” solution**

An “unorthodox” solution

- The Q-Pix pixel readout follows the “electronic principle of least action”
 - **Don't do anything unless there is something to do**
 - Offers a solution to the immense data rates
 - Quiescent data rate $\mathcal{O}(50 \text{ Mb/s})$
 - Allows for the pixelization of massive detectors
- Q-Pix offers an innovation in signal capture with a new approach and measures **time-to-charge:(ΔQ)**
 - Keeps the detailed waveforms of the LArTPC
 - Attempts to exploit ^{39}Ar to provide an automatic charge calibration
- **“Novelty does not automatically confer benefit”**
 - Much remains to be explored

Q-Pix: The Charge Integrate-Reset (CIR) Block

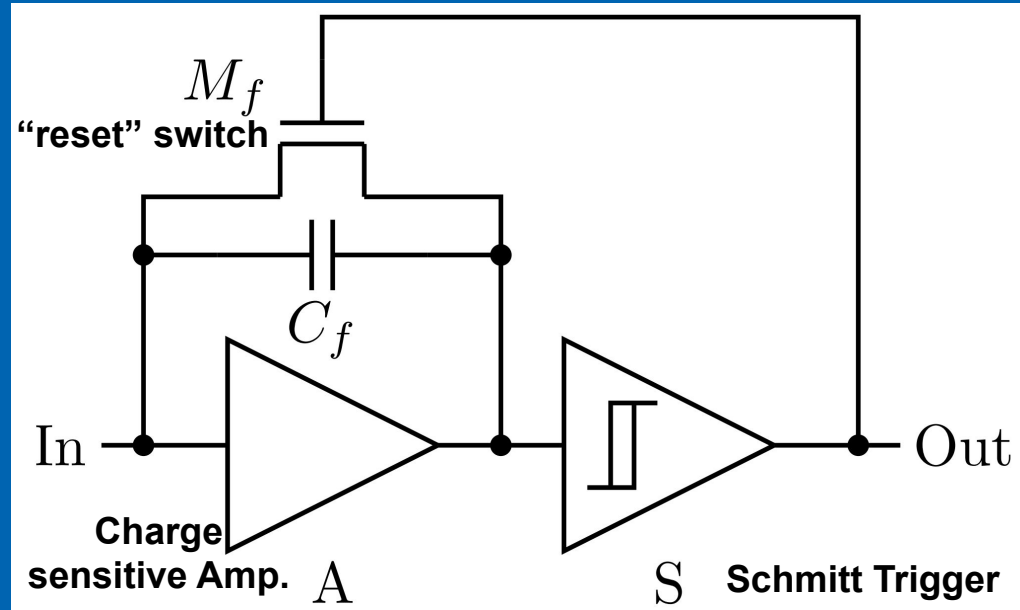

- Charge from a pixel (In) integrates on a charge sensitive amplifier (A) until a threshold ($V_{th} \sim \Delta Q / C_f$) is met which fires the Schmitt Trigger which causes a reset (M_f) and the loop repeats

Q-Pix: The Charge Integrate-Reset (CIR) Block

- Measure the time of the “reset” using a local clock (within the ASIC)
- Basic datum is 64 bits
 - 32 bit time + pixel address + ASIC ID + Configuration + ...

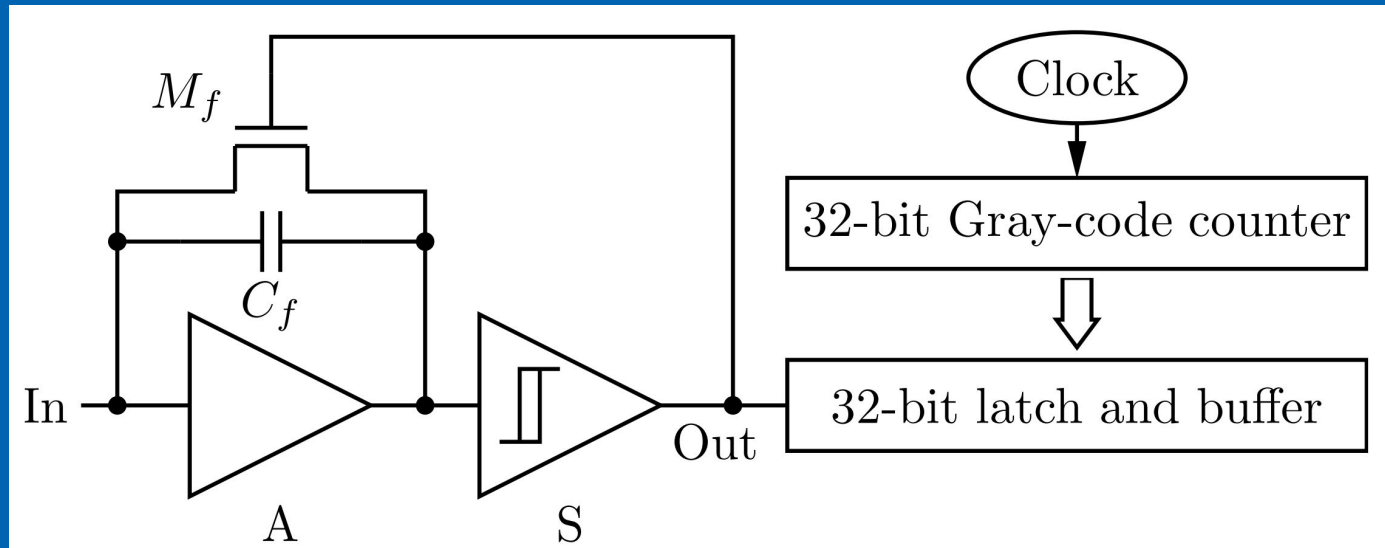

What is new here?

- Take the difference between sequential resets
 - Reset Time Difference = RTD
- Total charge for any **RTD = ΔQ**
- RTD's measure the **instantaneous current** and captures the waveform
 - Small average current (background) = **Large RTD**
 - **Background from $^{39}\text{Ar} \sim 100 \text{ aA}$**
 - Large average current (signal) = **Small RTD**
 - **Typical minimum ionizing track $\sim 1.5 \text{ nA}$**
- Signal / Background $\sim 10^7$
 - Background and Signal should be easy to distinguish
 - No signal differentiation (unlike induction wires)

Reset Time Difference

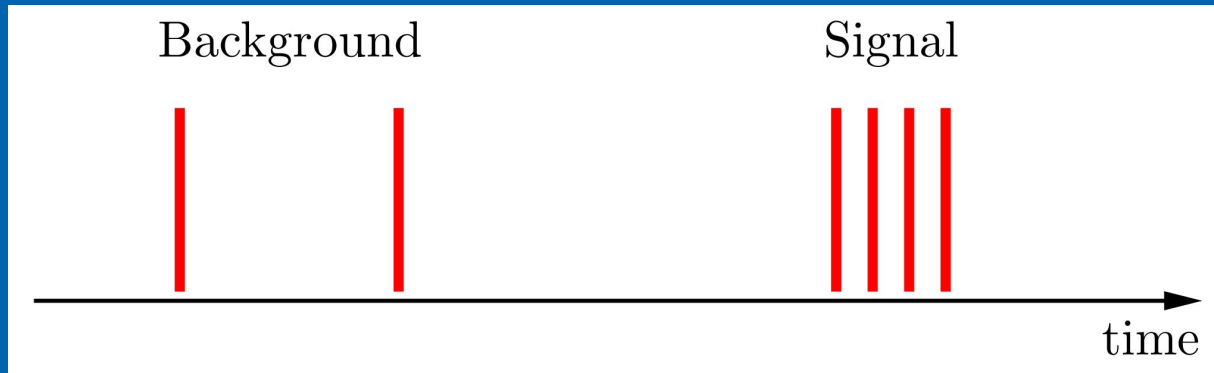
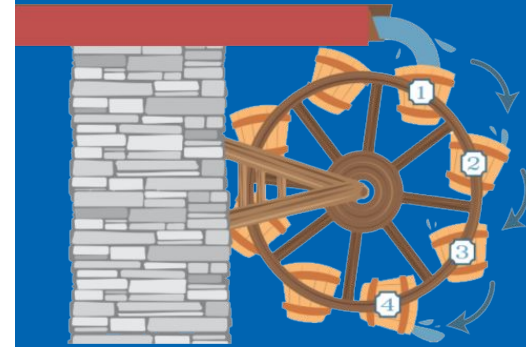
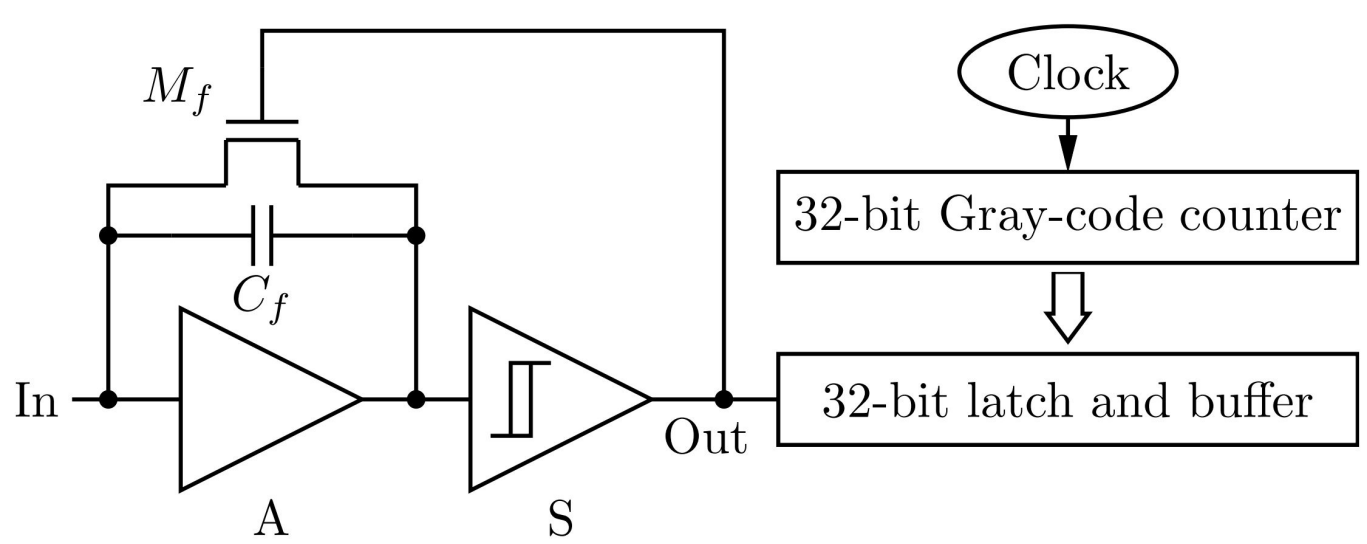

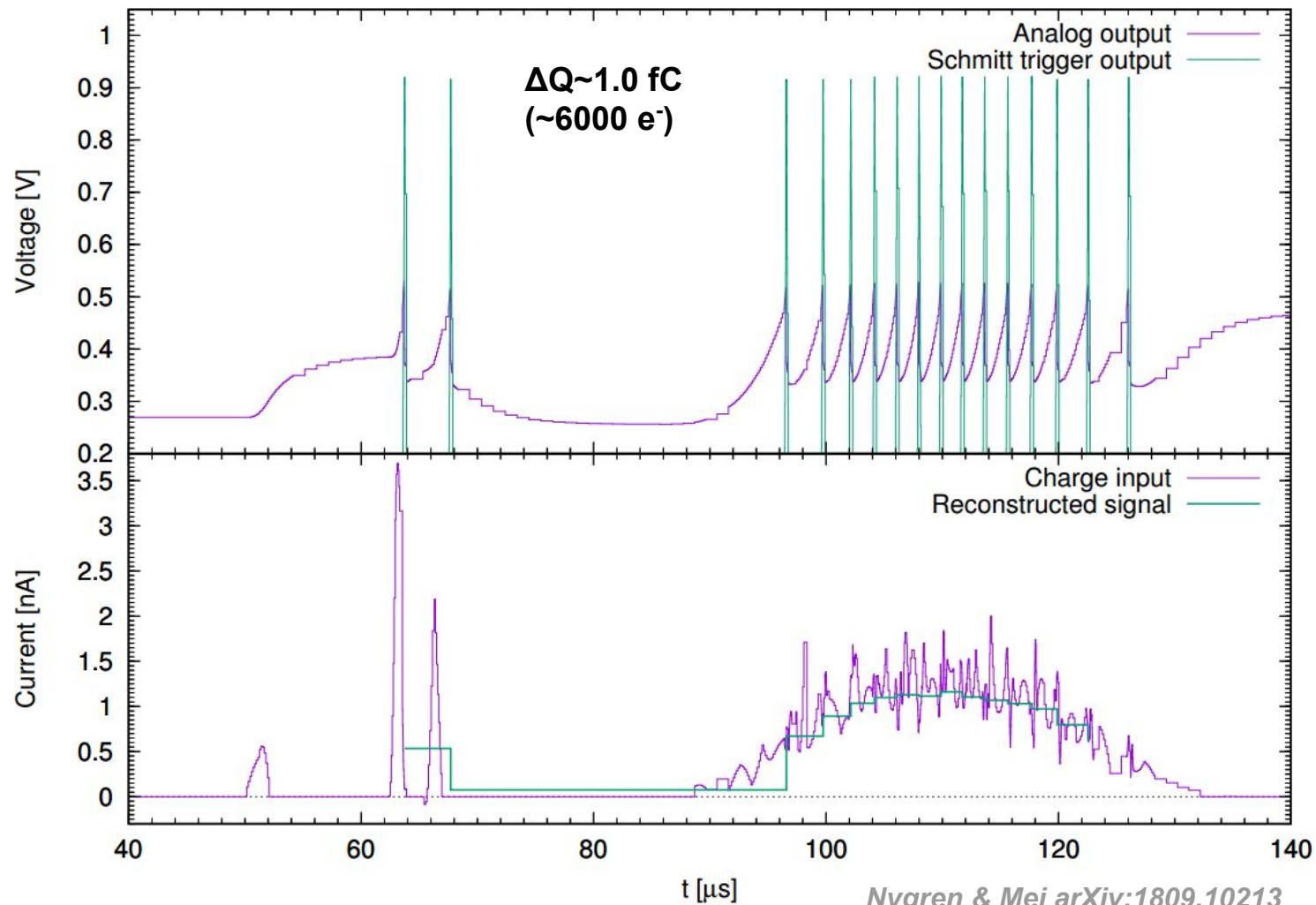

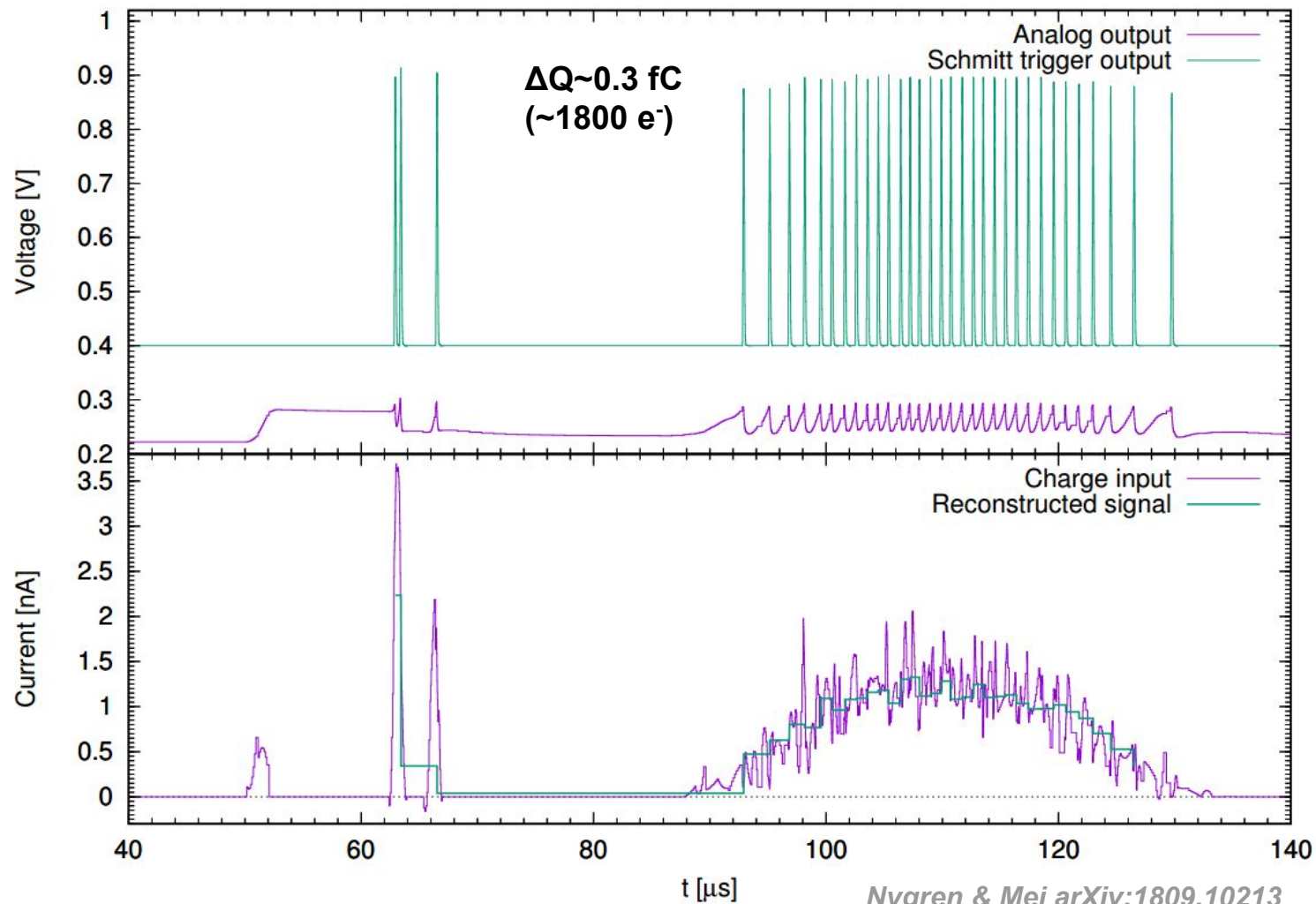

How the time stamping works

- **One free running clock per ASIC (50-100 MHz)**
 - Required precision for DUNE $\delta f/f \sim 10^{-6}$ per second
 - Expect this to be easily achieved in liquid argon
- **Time stamping routine has the ASIC asked once per second “what time is it?”**
 - ASIC captures local time and sends it
 - Simple linear transformation to master clock synced to GMT
 - RTD’s calculated “off chip”
- **Has this idea been realized before?**
 - **YES! In ICECUBE (by Nygren)**
 - Oscillator precision achieved $> 10^{-10}$ /s (hard to measure)

Q-Pix ASIC Concept

- **16-32 pixels / ASIC**
 - 1 Free-running clock/ASIC
 - 1 capture register for clock value, ASIC, pixel subset
 - Necessary buffer depth for beam/burst events
 - State machine to manage dynamic network, token passing, clock domain crossing, data transfer to network (many details to be worked out)
- **Basic unit would be a “tile” of 16x16 ASICs (4092 4mm x 4mm pixels)**
 - Tile size 25.6 cm x 25.6 cm

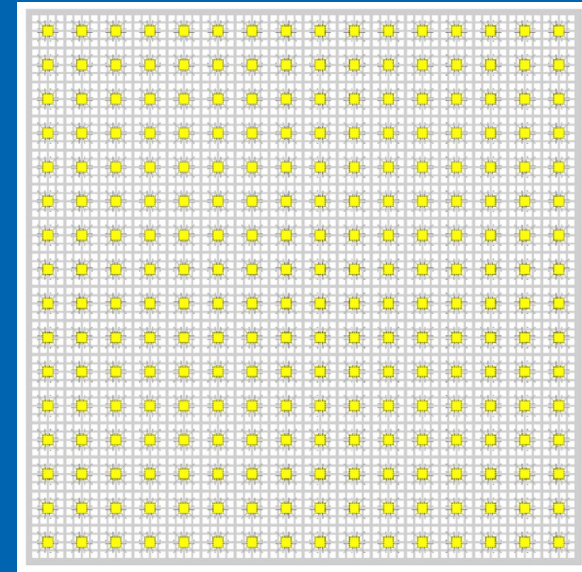
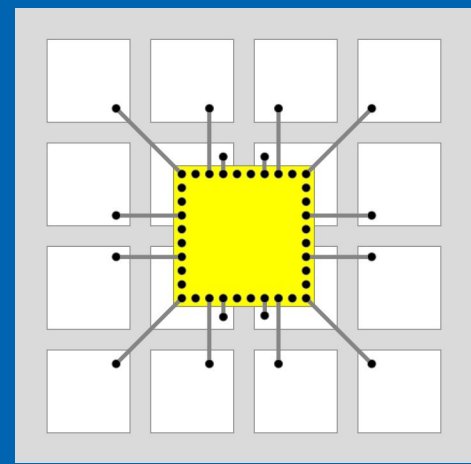

Q-Pix ASIC Concept

- **ASICs will be in one of six states**
 - Data Acquisition (DAQ)
 - Local Time Capture (LTC)
 - Wave Propagation (WP)
 - Data Transfer (DT)
 - Initiate Data Acquisition (IDAQ)
 - Control State (CS)
- **A major feature of Q-Pix is dynamic network generation within a tile.**

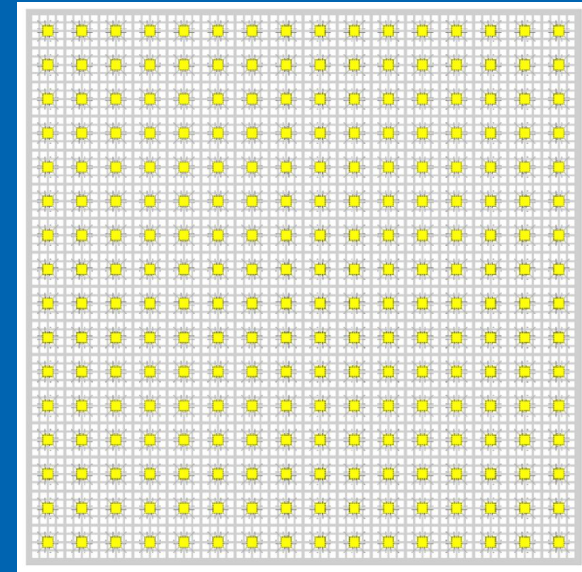
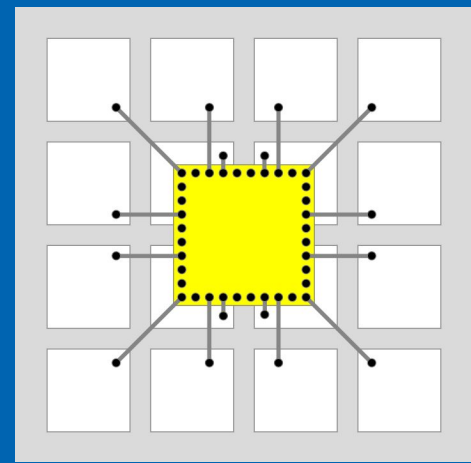

Local Time Capture

A transition to this state begins with the introduction of an **accurately timed 'time stamp token'** at a chosen place on the periphery of the tile.

More than one available entry point is foreseen to reduce SPF risk.

This first ASIC to receive the token then asserts the token in a defined sequence to all of its other x-y neighbors; in principle, up to three neighbors could accept.

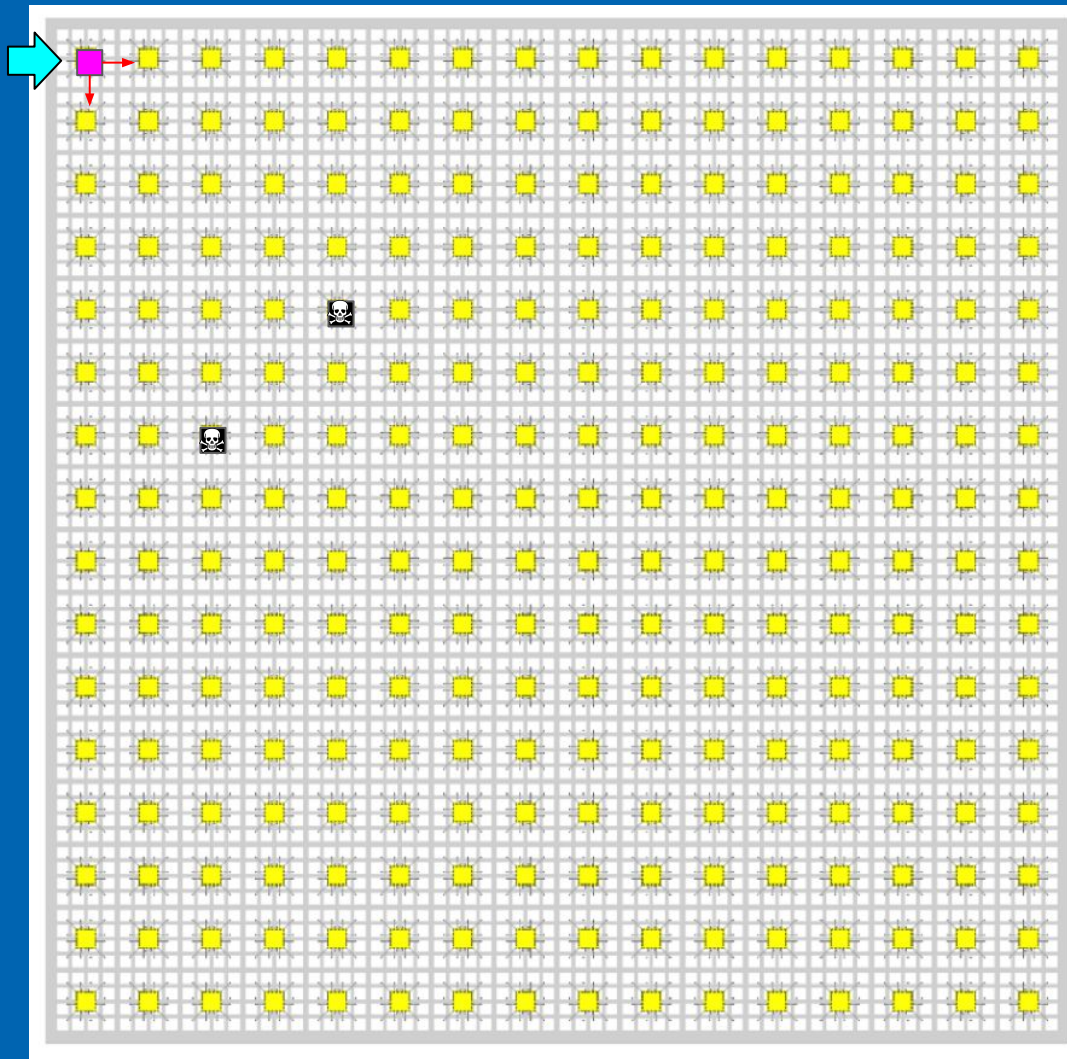

Wave Propagation(WP)

Neighboring ASICs now receive the token.

Assertion to one ASIC by two neighbors is resolved by the accepting ASIC choosing just one, following a pre-programmed sequence.

Each ASIC in this chain remembers from whom it has accepted the token.

An intra-tile network is thus dynamically established and maintained.

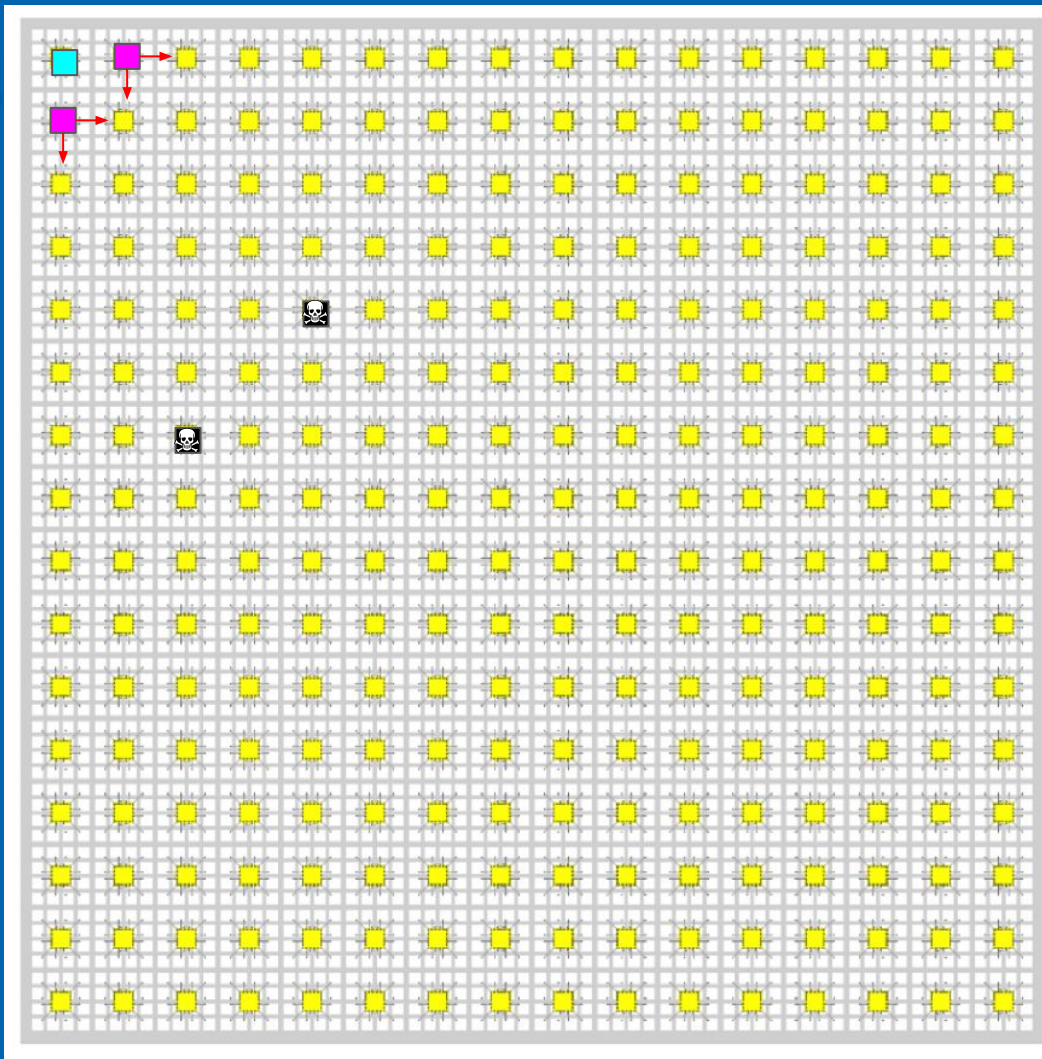

Data Transfer (DT)

As soon as the first ASIC learns that the token has been either accepted or rejected by all of its neighbors, **readout of all of its data captured** since the previous time-stamp token will commence.

Data will include at least the one forced time capture caused by the time-stamp token.

Each ASIC attempts to push backward its data to the ASIC from whence it accepted the time-stamp token.

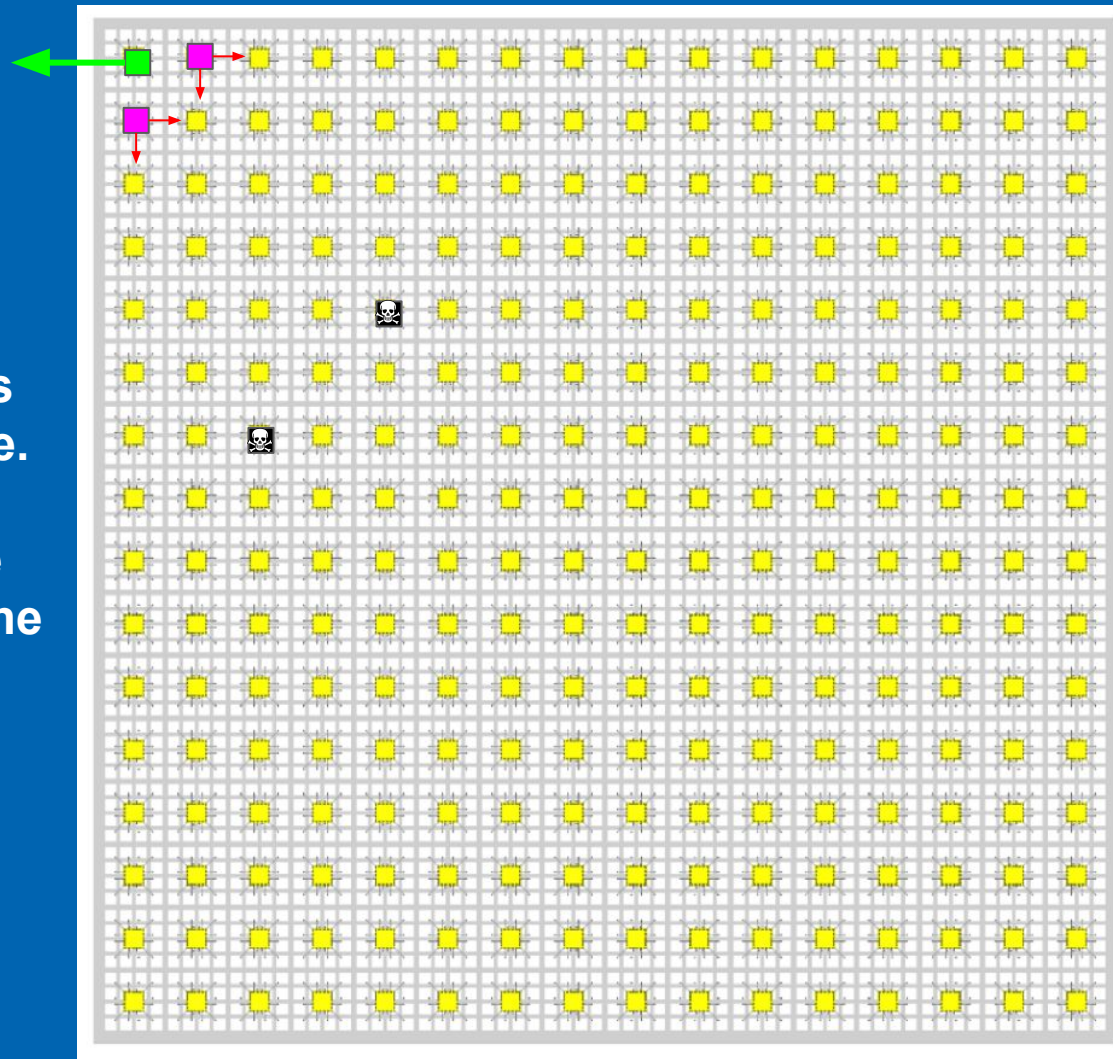

WP and DT continues

When an ASIC is empty after data transfer it must accept a data transfer token impressed from any neighbor.

All data is pushed through the dynamically established network to complete the DT. The DT phase reproduces the LTC wave in reverse but much more slowly.

Off-plane data acquisition external to the cryostat determines when all ASICs have reported data, permitting transition back to DAQ

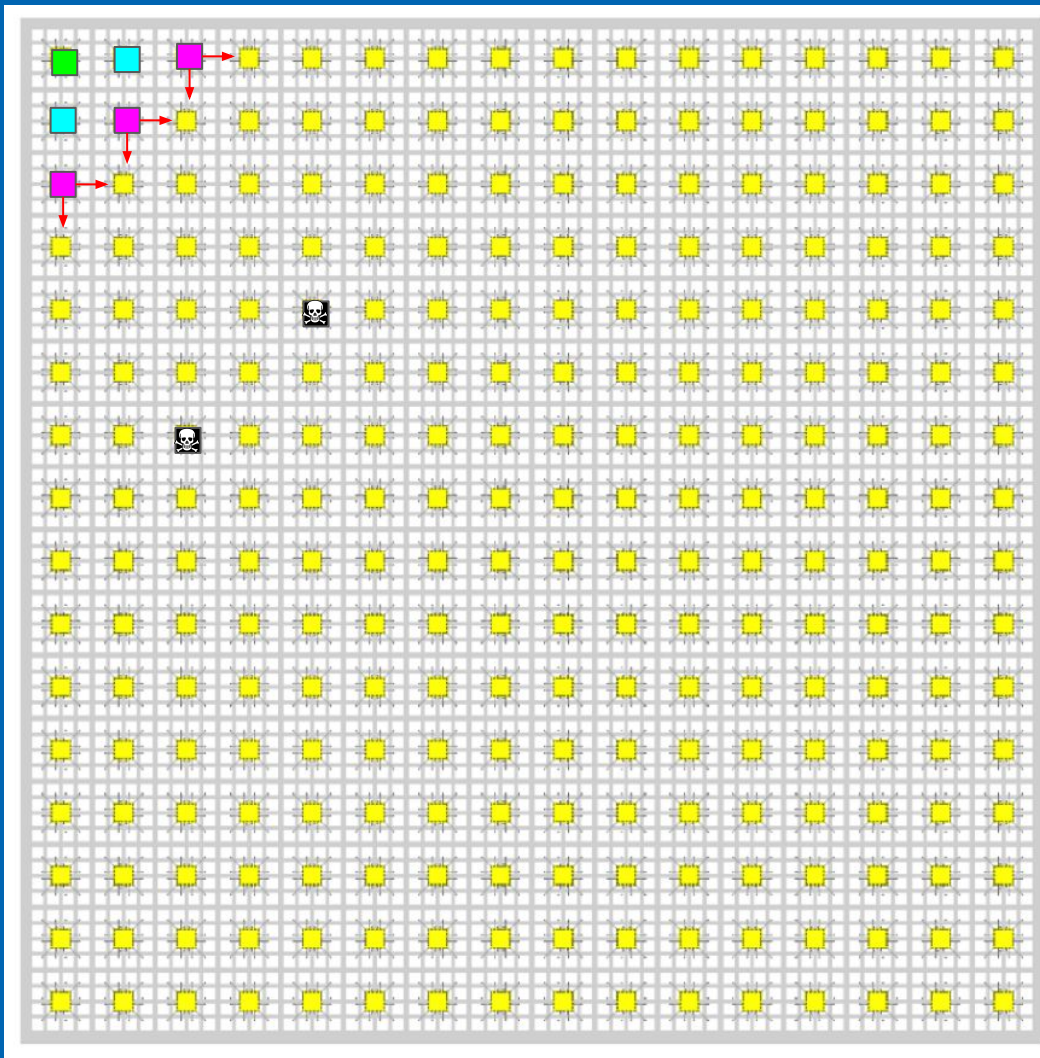

WP and DT continues

Data are likely to be pushed through an average of perhaps 16 ASICs but it seems unlikely to be pushed through more than 32 ASICs.

While an inefficiency is present here, the data load is very small and infrequent.

Very substantial resilience and mechanical simplicity is obtained.

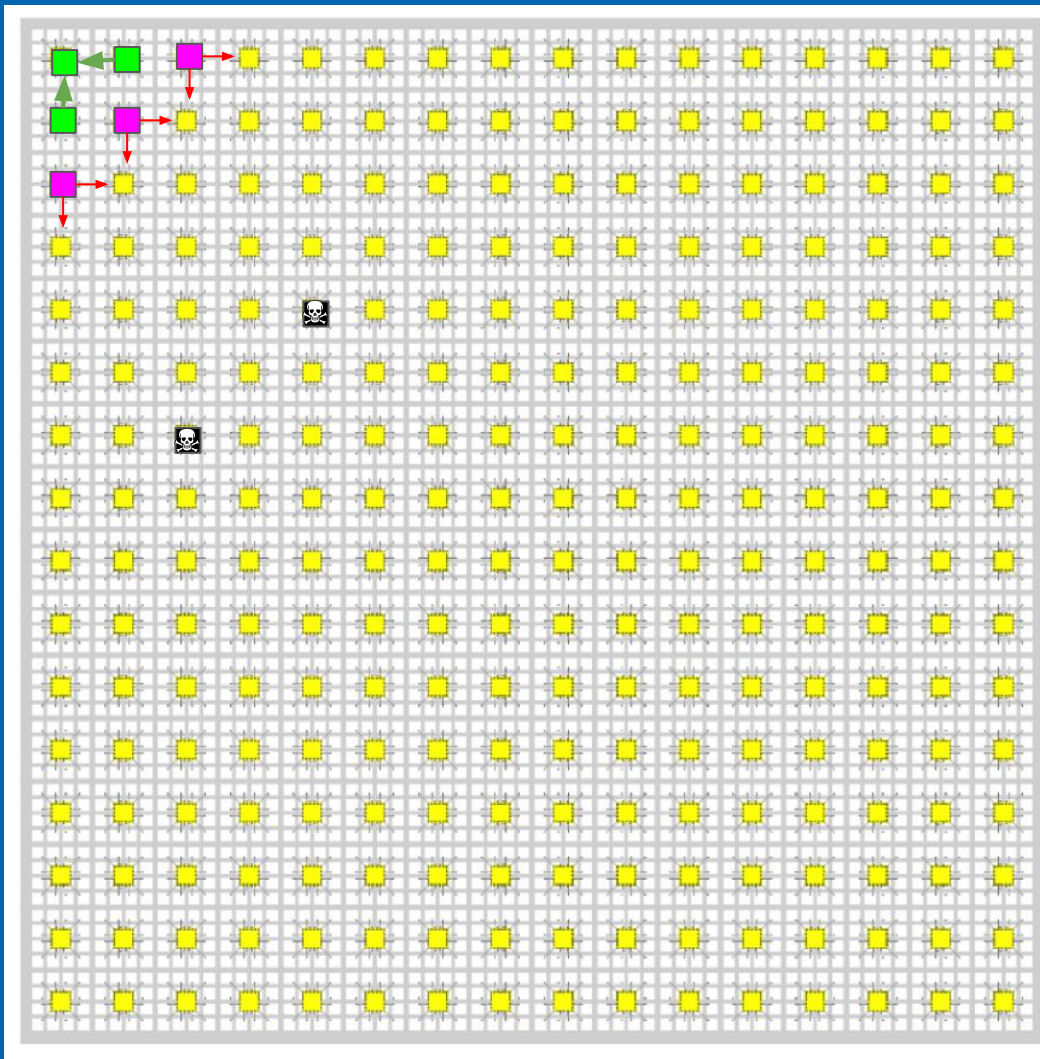

And the beat goes
on....

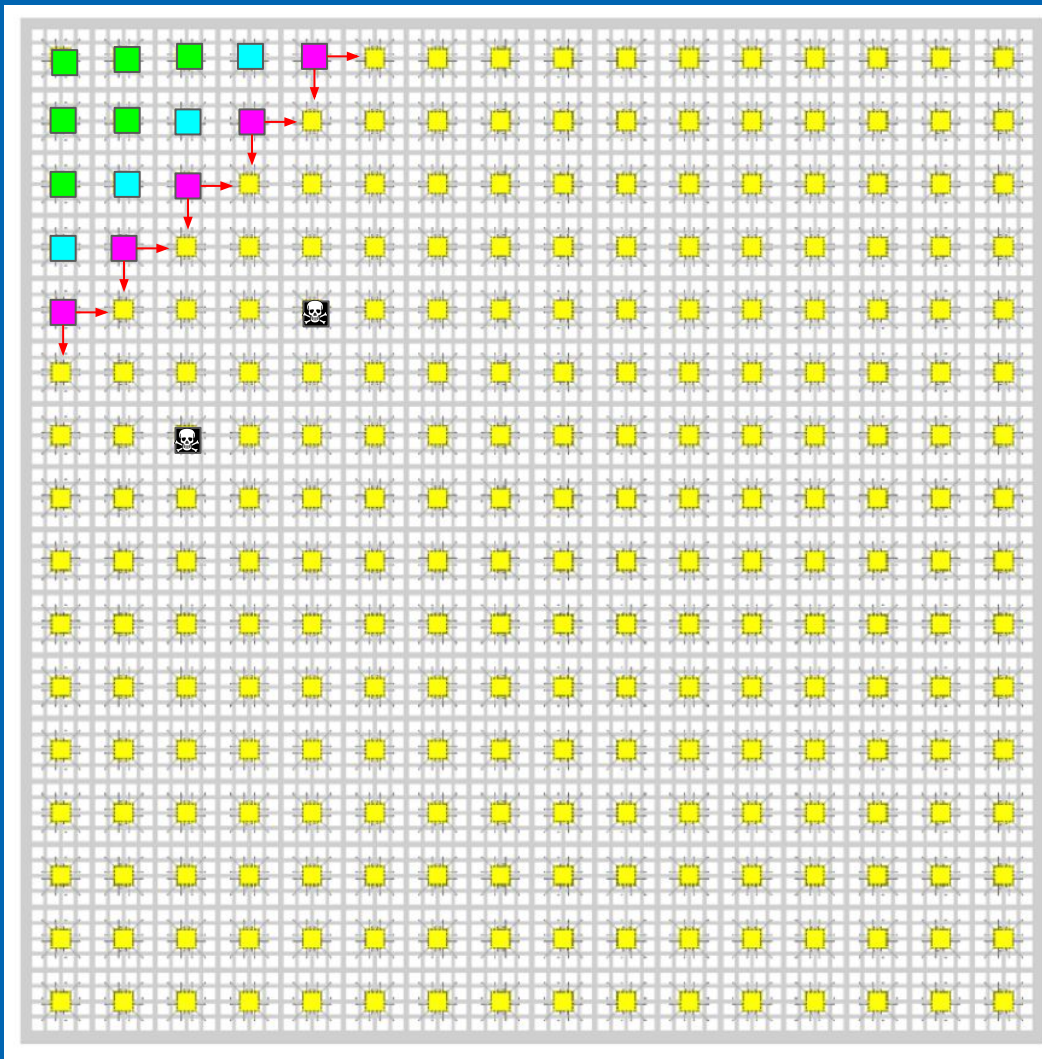

And the beat goes
on....

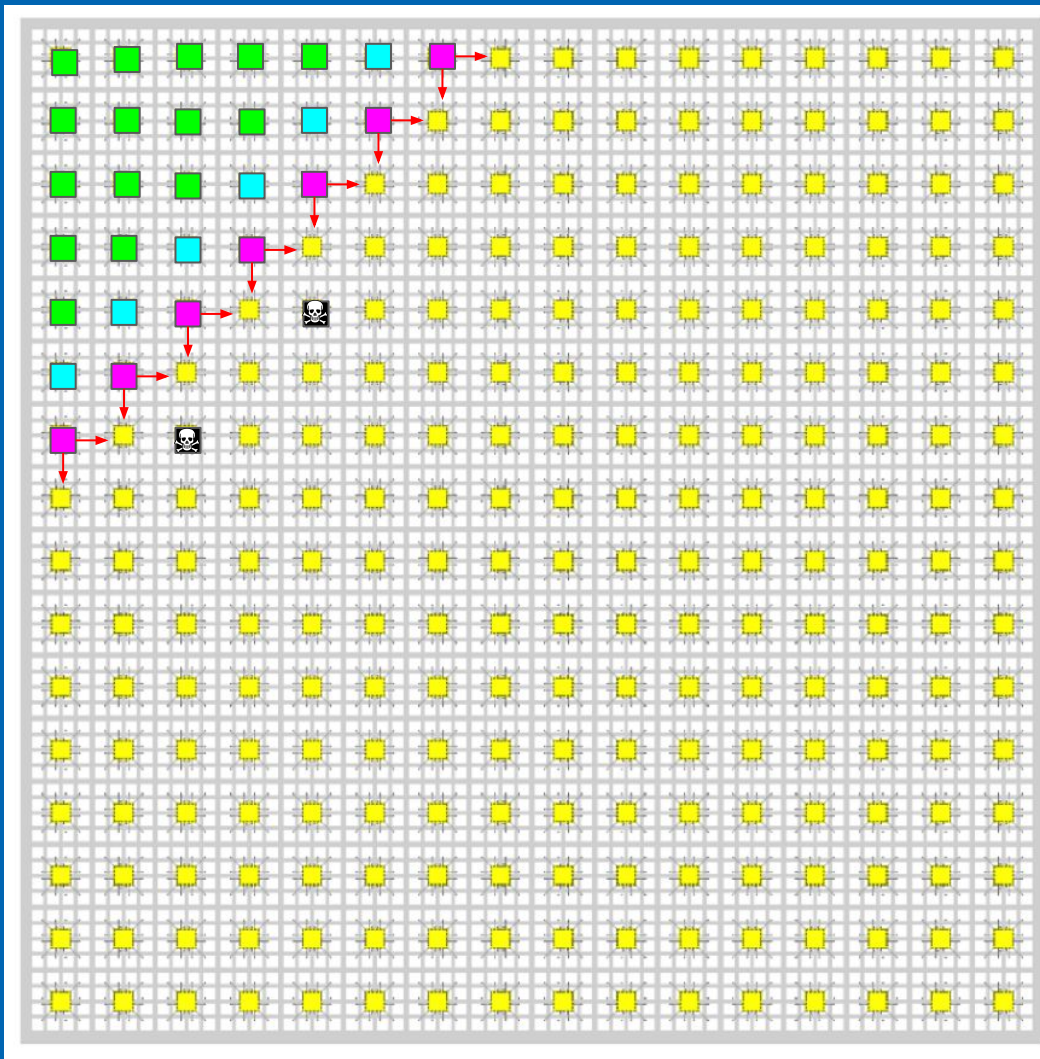

Resilience to Single Point Failure

Unresponsive chip(s) will be bypassed by the encircling wave.



= dead/unresponsive chip

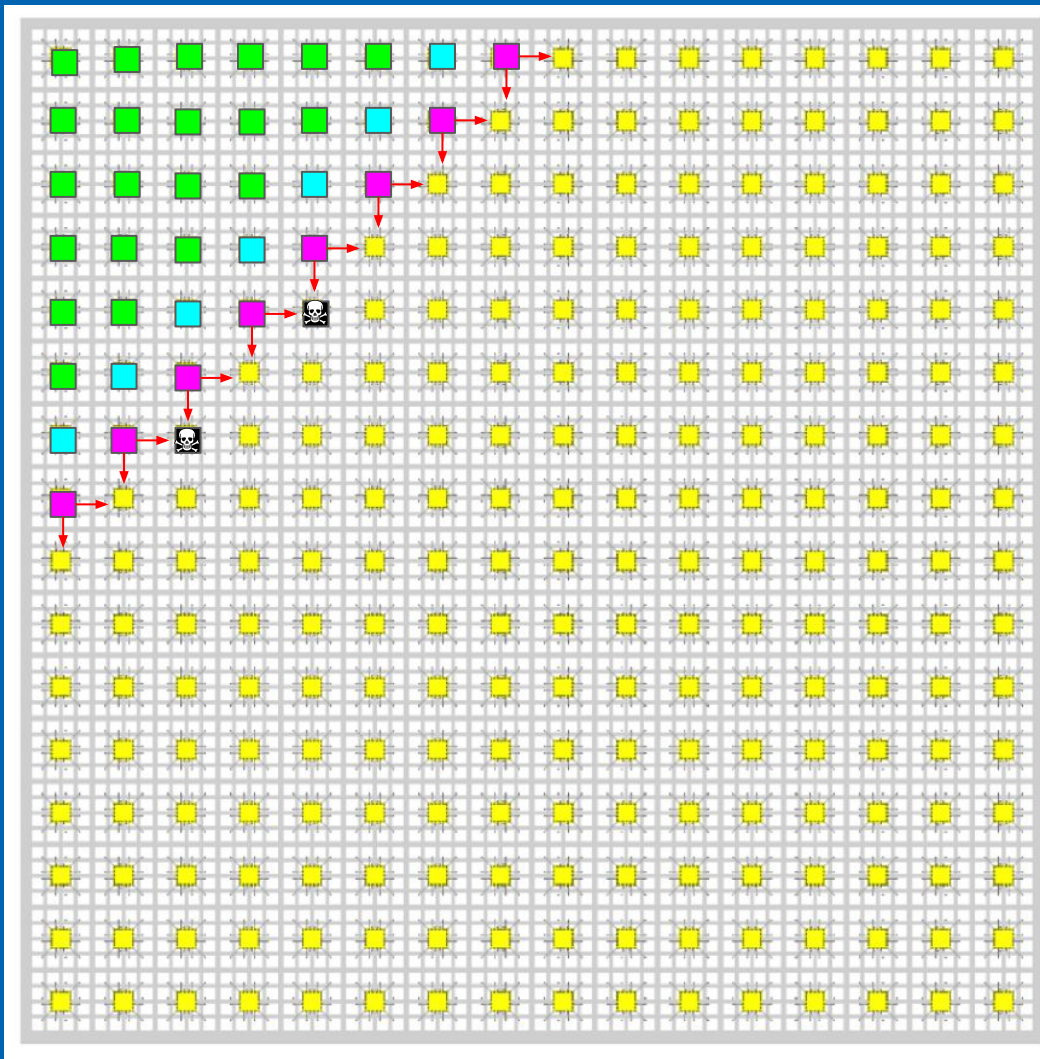

Resilience to Single Point Failure

Unresponsive chip(s) will be bypassed by the encircling wave.



= dead/unresponsive chip

Should an ASIC fail at any time a new dynamic network must, and will, automatically establish itself.

Although the network pattern itself is irrelevant, it can be recovered from the sequence of received data.

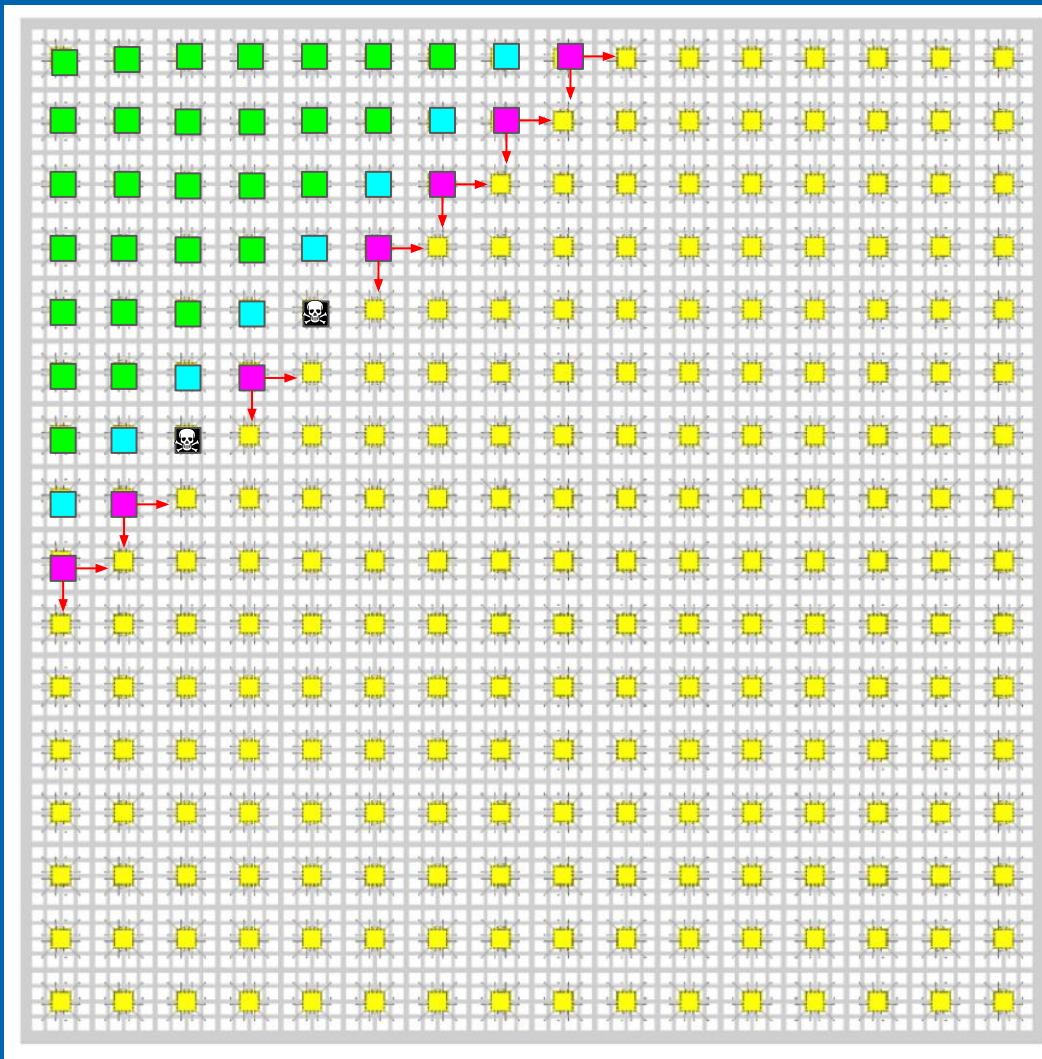

Resilience to Single Point Failure

Unresponsive chip(s) will be bypassed by the encircling wave.



= dead/unresponsive chip

Should an ASIC fail at any time a new dynamic network must, and will, automatically establish itself.

Although the network pattern itself is irrelevant, it can be recovered from the sequence of received data.

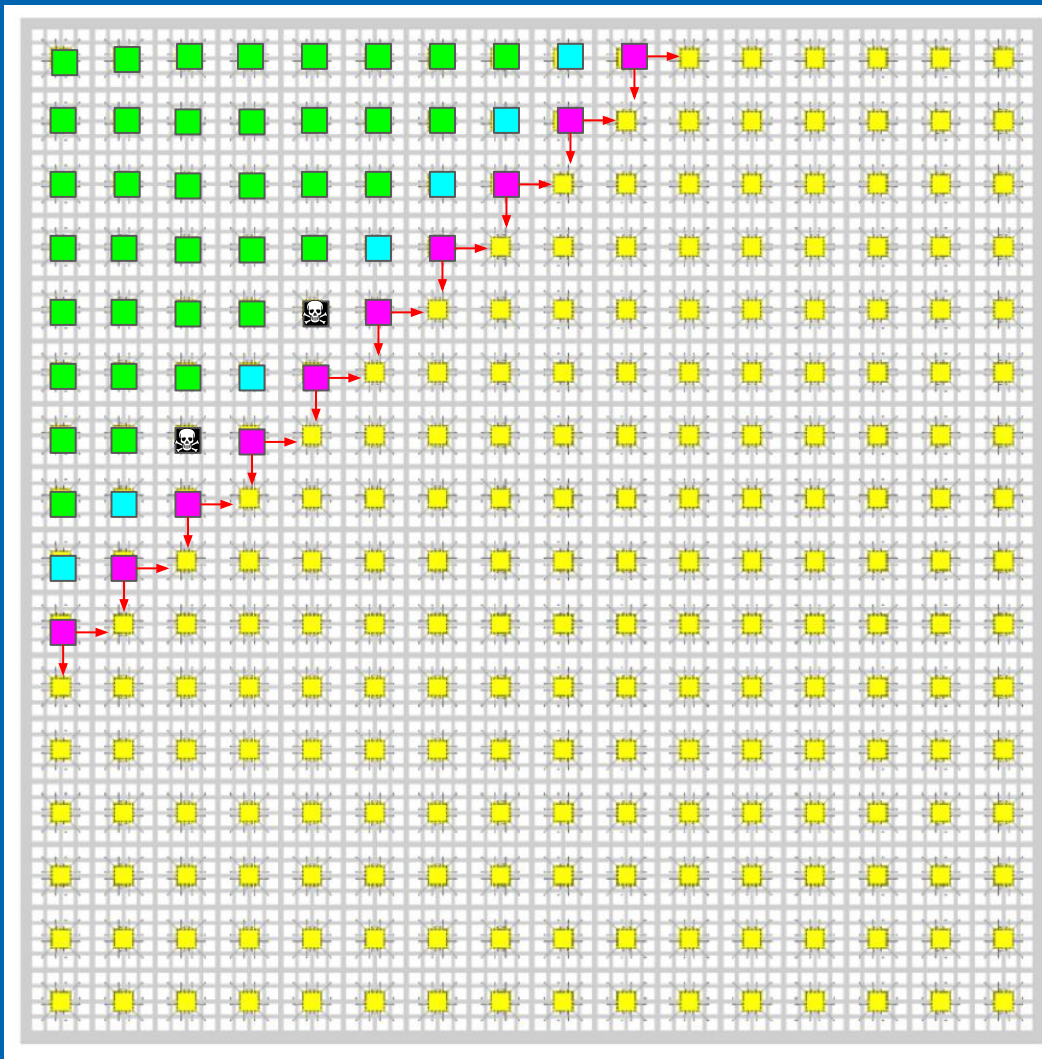

Data Rates for 10 kTon

- We imagine each tile is 16x16 ASICs and one readout plane (APA) has 11,136 tiles per APA
- We perform the clock calibration 1/second (perhaps less often)
 - This gives 16,384 bits / tile
- The total data rate is thus set by the number of readout planes
 - 7 meter drift = 2 APA's = 16,384 bits/tile x 22,276 tiles ~ 40.5 Mbytes/s
 - 3.5 meter drift ~ 90.5 Mbytes/s
 - The detector can be made more modular!
 - Reduce the demands on the HV, purity, diffusion, etc...

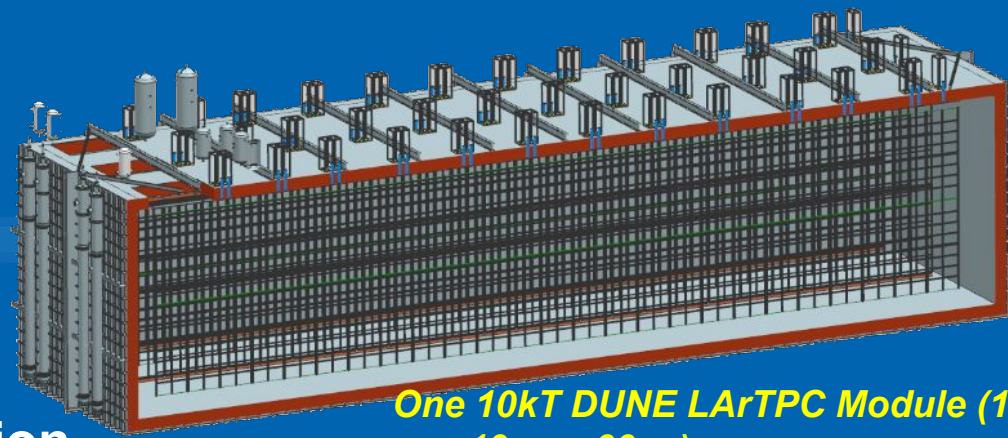

*One 10kT DUNE LArTPC Module (18 m x 19 m x 66 m)
1/4 the total size of DUNE*

Q-Pix Consortium

- A consortium of universities and labs has formed to realize and test the Q-Pix concept
 - Being done in close collaboration with LArPix (JINST 13 P10007) readout for the DUNE near detector

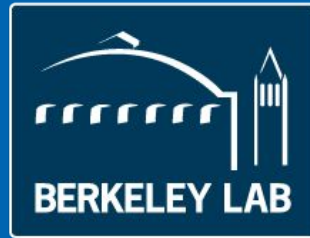

Q-Pix Consortium

- Four central ideas being worked on
 - **Physics Simulations:** Quantify the conferred benefit of pixel vs. wire readout and the requirements of the ASIC design
 - **CIR Input:** all extraneous leakage current at the input node needs to be small (aA)
 - **Clock:** $\delta f/f \sim 10^{-6}$ per second
 - **Light Detection:** Exploring new ideas using photoconductors on the surface of the pixels

Physics Simulation

- To help quantify the range of currents the Q-Pix ASIC will need to reconstruct we are using neutrino interactions in argon

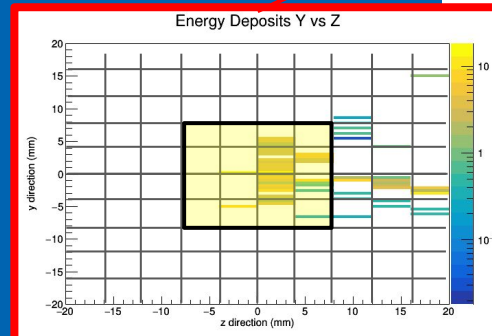
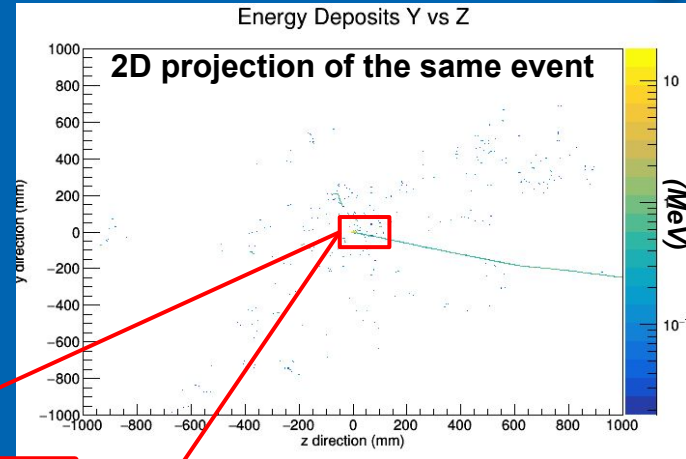
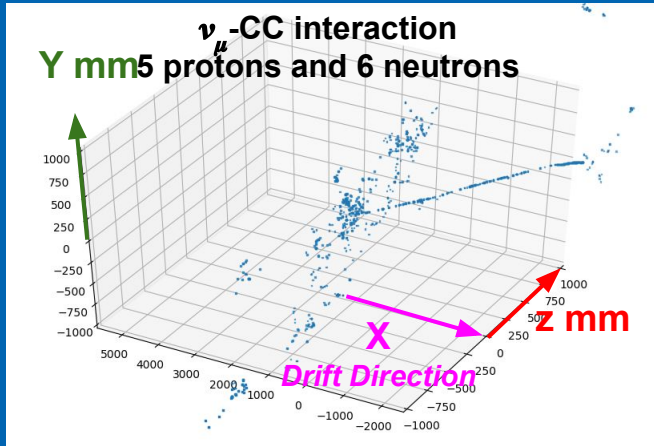

Focus on a 16mm x 16mm (4pixels x 4pixels) area around the vertex to get a sense of the currents that would be seen

Physics Simulation

- We can take the charge seen by a pixel and translate this into current as a function of time

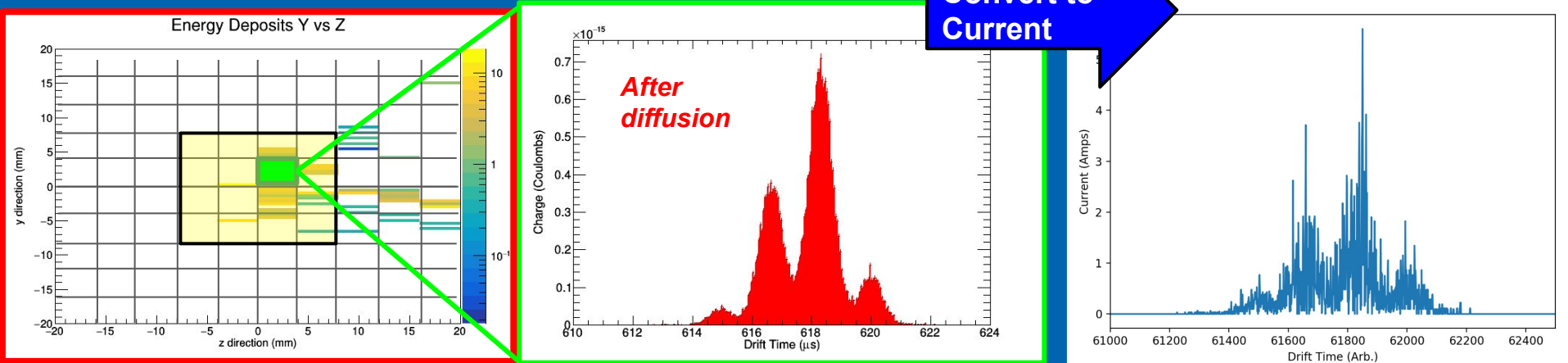

- We can then use this simulation to set the physics requirements on the Q-Pix ASIC
 - Allowed reset time, minimum ΔQ , etc...
 - Ongoing studies exploring non-beam (supernova, proton decay, etc...) and beam related parameters

Physics Simulation

- We are also developing the full charge response using Boundary Element Method (BEM++)
 - Estimate the response and any induced charge seen on adjacent pixels
 - Preliminary results suggest this is $\mathcal{O}(1\%)$

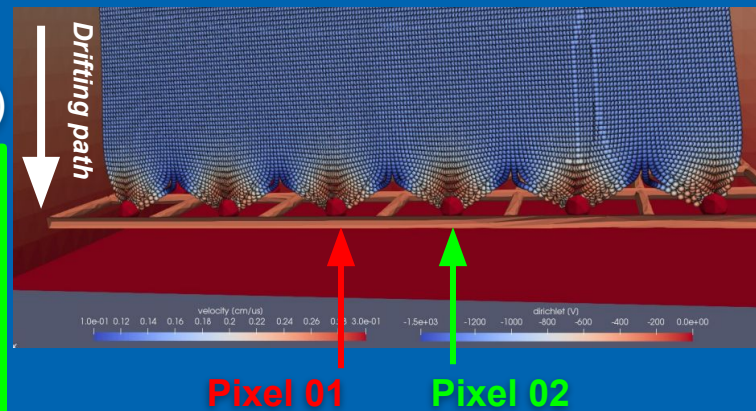
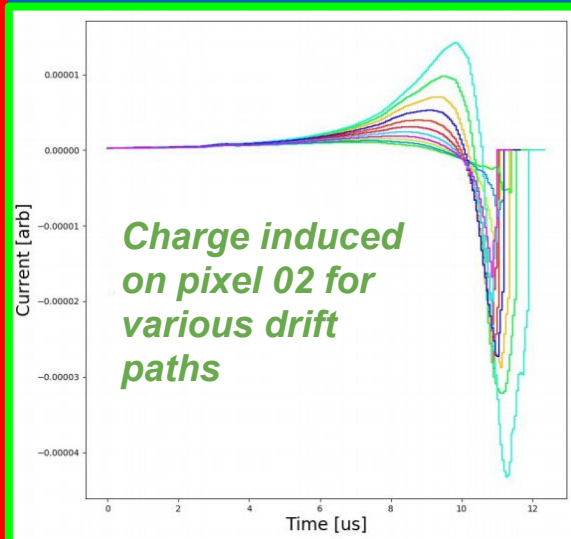
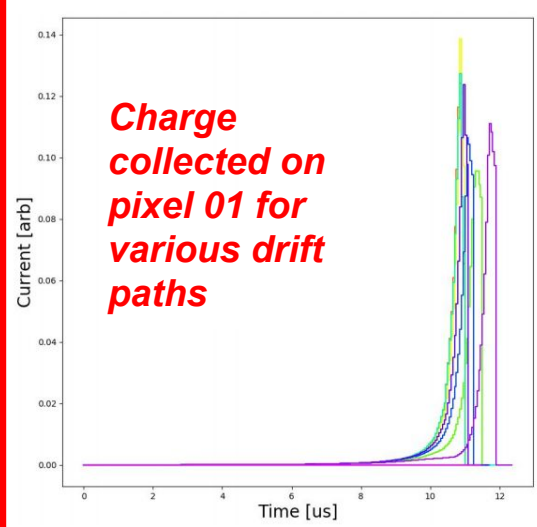
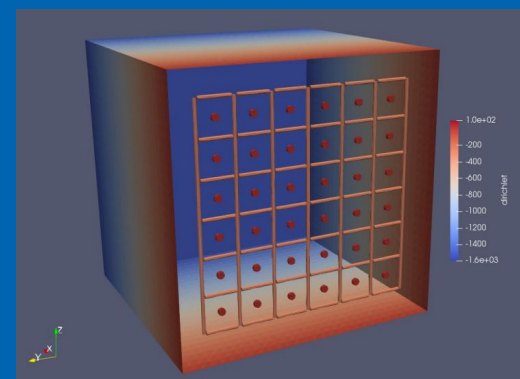

Physics Simulation

- Measurement of Longitudinal Diffusion
 - Using a sample of 10 muons a novel technique allowed by Q-Pix can already be seen

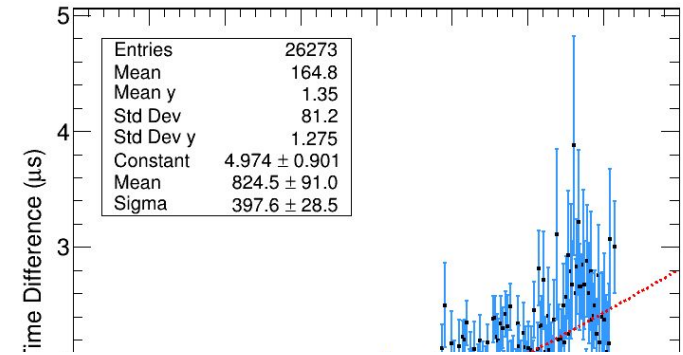

The electron current measured on a plane perpendicular to the drift direction at a distance d from a point source is given by

$$j(t) = \frac{n_0}{\sqrt{4\pi D_L t}} \exp\left(-\frac{(d - vt)^2}{4D_L t} - \lambda vt\right) \quad (2)$$

where n_0 is the initial electron density, v is the drift speed, t is the arrival time of the electrons on the plane, and λ is equal to the inverse of the mean free path of the electron.

This function approaches a true Gaussian when $d \cdot v$ is large and D_L is small. For the case being considered $v = 0.1648 \text{ cm}/\mu\text{s}$ and $d > 10 \text{ cm}$ so, $d \cdot v \geq 1.6 \times 10^5 \text{ cm}^2/\text{s}$. This is large when compared to $D_L = 6.82 \text{ cm}^2/\text{s}$.

- Measurement of Longitudinal Diffusion
 - Using a small sample muons a novel technique in Q-Pix can be seen

The electron current measured on a plane perpendicular to the drift direction at a distance d from a point source is given by

$$j(t) = \frac{n_0}{\sqrt{4\pi D_L t}} \exp\left(-\frac{(d - vt)^2}{4D_L t} - \lambda vt\right) \quad (2)$$

where n_0 is the initial electron density, v is the drift speed, t is the arrival time of the electrons on the plane, and λ is equal to the inverse of the mean free path of the electron.

This function approaches a true Gaussian when $d \cdot v$ is large and D_L is small. For the case being considered $v = 0.1648 \text{ cm}/\mu\text{s}$ and $d > 10 \text{ cm}$ so, $d \cdot v \geq 1.6 \times 10^5 \text{ cm}^2/\text{s}$. This is large when compared to $D_L = 6.82 \text{ cm}^2/\text{s}$.

The Reset Time Difference (RTD) literally stands for

$$RTD = \frac{\Delta Q}{\Delta t} = j(t) \quad (6)$$

Thus if we plot the average RTD seen over a sample as a function of the drift distance, we should see the Gaussian relationship

Physics Simulation

- Measurement of Longitudinal Diffusion

- The average RTD versus the drift length yields a distribution which carries the diffusion information along with it
- Allows for a fundamental measurement with few statistics

- $D_L^{\text{Measured}} = 6.47 \pm 0.97 \text{ cm}^2/\text{s}$

- $D_L^{\text{Simulation}} = 6.82 \text{ cm}^2/\text{s}$

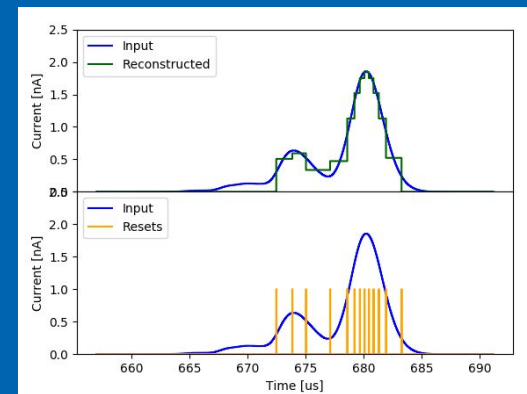
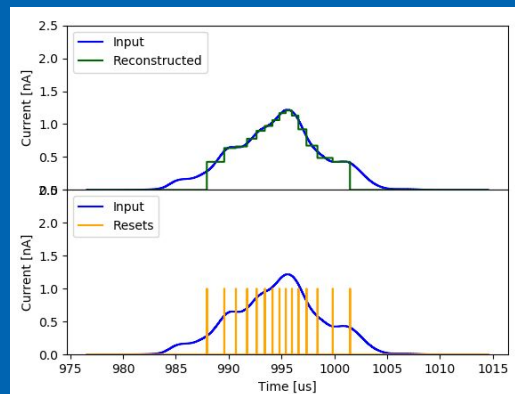
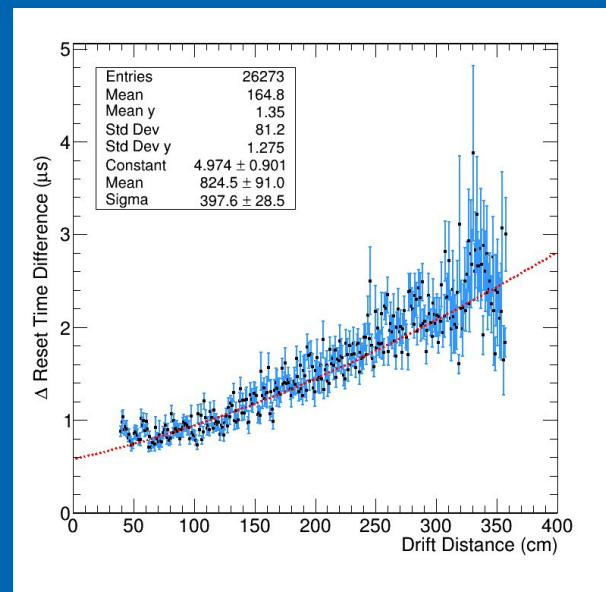

Light Detection

- One very “blue sky” idea currently being considered is to see if the same pixels which collect ionization charge can be used to detect UV photons

- Currently exploring different thin-film photo-conductors which may offer an opportunity
- Exploring amorphous Selenium’s properties
 - Commonly used in X-Ray digital radiography devices

- If realized, offers a transformative opportunity in LArTPC’s

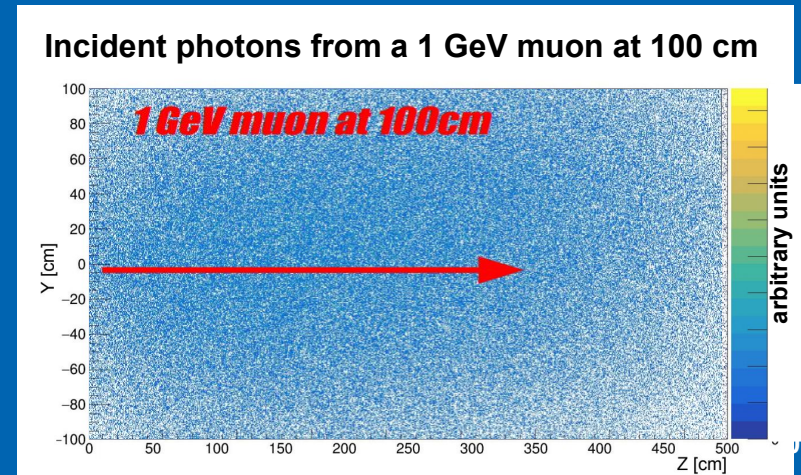
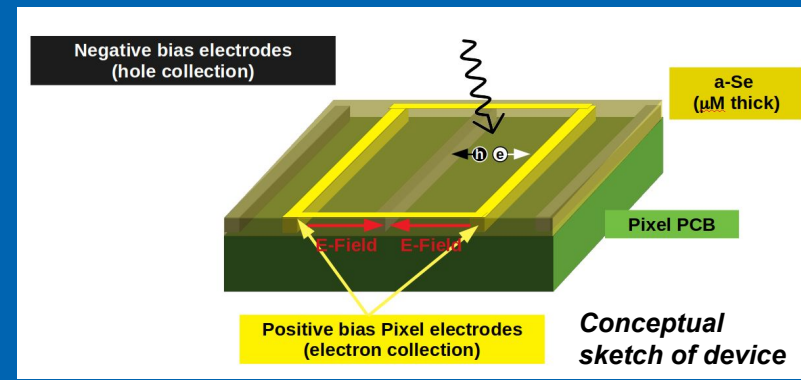

2 - 10 photons per pixel

Amorphous Selenium

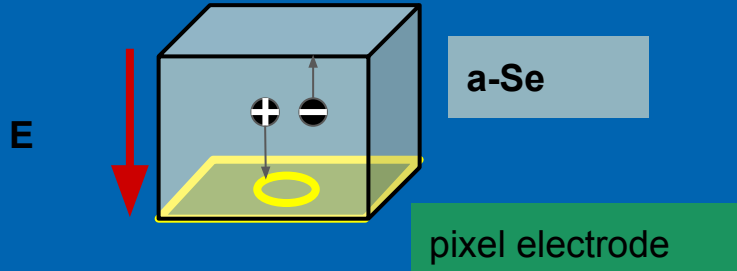

For the moment, I will assume I can apply a uniform electric field on a block of a-Se (some micrometers thick) where the electron-hole pair is being created

To figure out the charge I will get, I need to figure out how thick a layer of amorphous selenium will give me a high quantum efficiency

$$\eta = 1 - e^{-\alpha L}$$

To know this, I need the attenuation coefficient for a-Se (α) for 128 nm (9.7 eV) photon

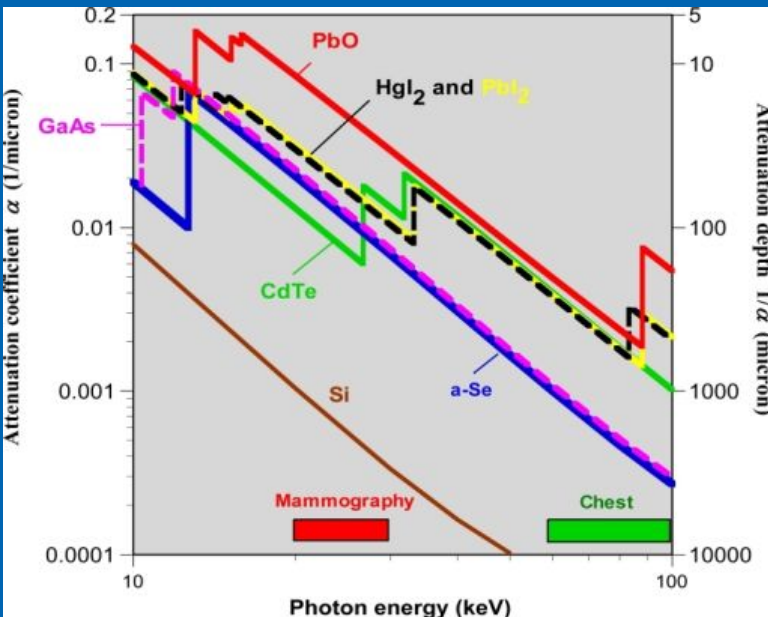

Amorphous Selenium

Found an older paper which had the coefficient measured for photons in the range we care about

Value from the plot suggests

$$\sim 1.3 \times 10^6 \text{ cm}^{-1} = 130 \mu\text{m}^{-1}$$

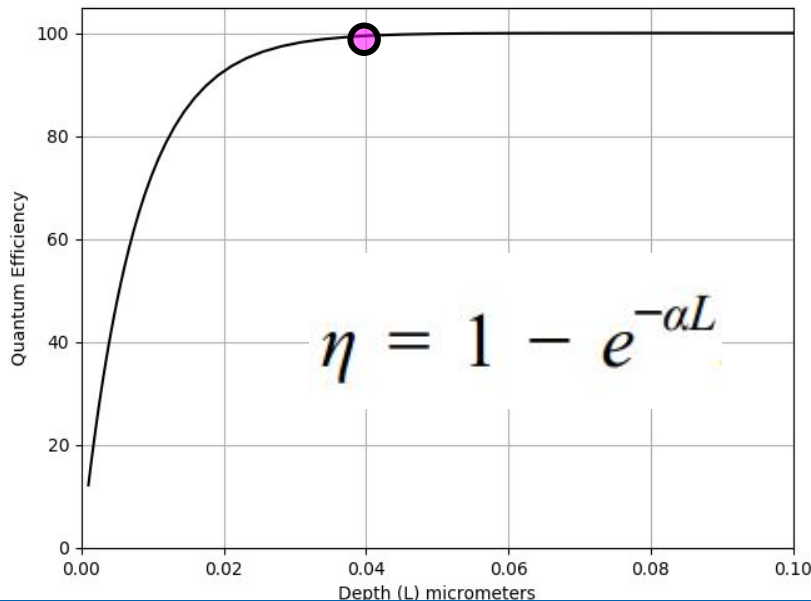

For 128 nm photons the Quantum Efficiency as a function of the thickness of the a-Se suggests:

- $>1 \mu\text{m}$ thickness = 99% QE

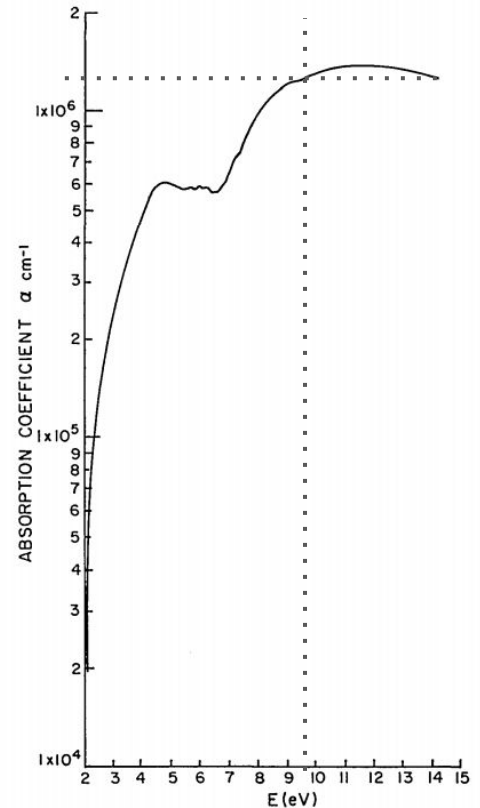

FIG. 6. The spectral dependence of the absorption coefficient, α , of amorphous selenium.

Modeling of amorphous Selenium to understand optical properties w/ VUV light

A condensed matter theorist colleague at UTA (Muhammad Huda) and his student (Sajib Barman) have agreed to do some calculations on the properties of amorphous Selenium to help better understand and predict the optical-electronic properties we could expect when exposed to 128 nm photons

- **Start w/ Generalized Gradient Approximations in Density Functional Theory**
 - Will add further approximations to capture experimentally measured properties
- **From there, can use phenomenological models to predict the optical-electronic properties**
- **What I'm sharing today is the very preliminary work**

Optical Absorbance
 $\alpha(\omega)$ (/m)

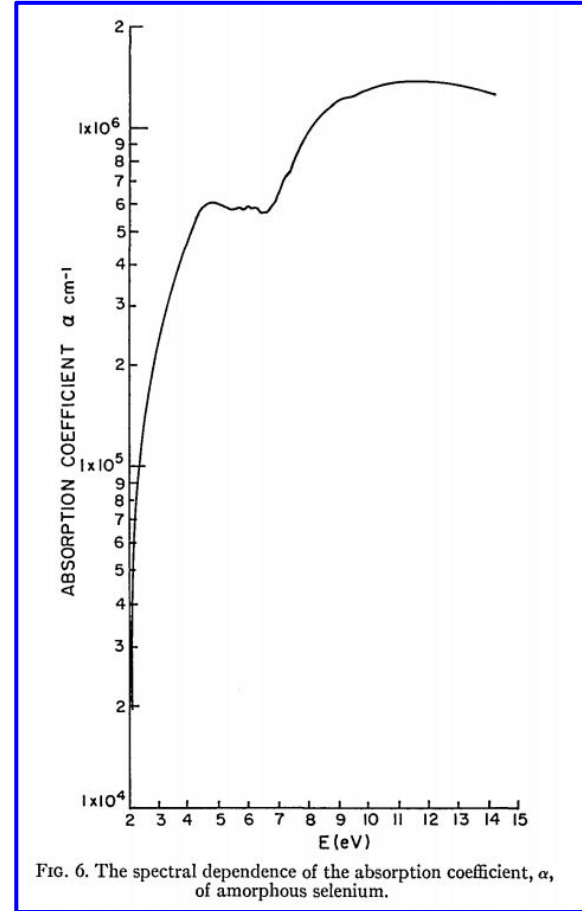
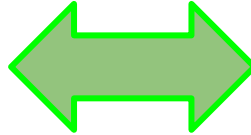
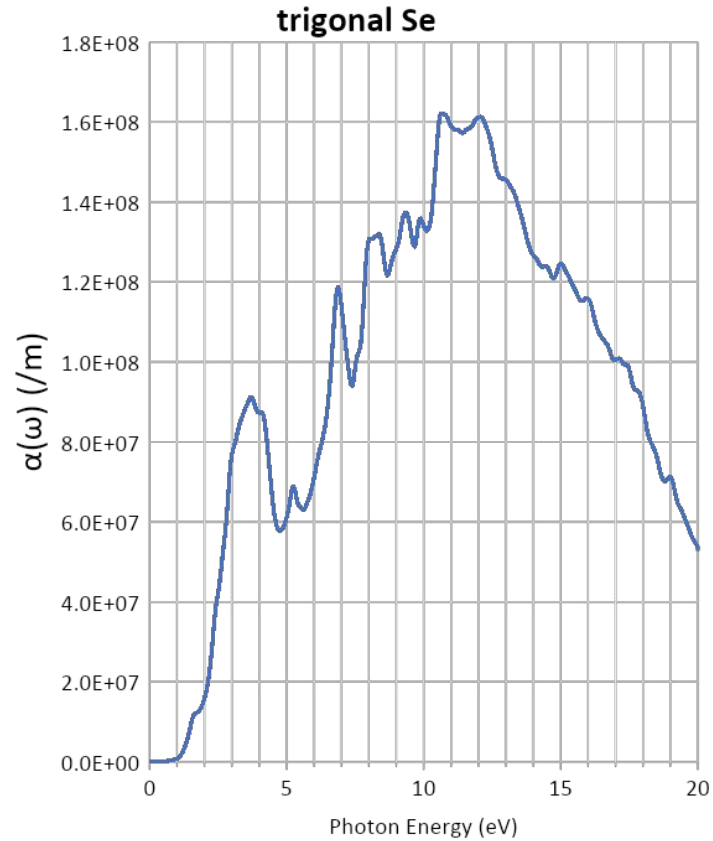

- Compared to experimental measurements from 60+ years ago...shows good agreement

Amorphous Selenium

The amount of charge deposited into the a-Se is given by

$$\Delta Q = q \frac{\Delta E}{W_{\pm}},$$

where ΔE is the amount of energy absorbed (we are assuming $26.46 \text{ eV} = 3 \text{ photons} \times 9.7 \text{ eV} / \text{photon} \times 0.9 \text{ QE}$), q is the fundamental charge of the electron, and W_{\pm} is a property of the mobility of a-Se (which depends on the electric field and temperature)

Literature search gives an approximate value for $W_{\pm} = 7.07 \text{ eV}$*

**see backup slides*

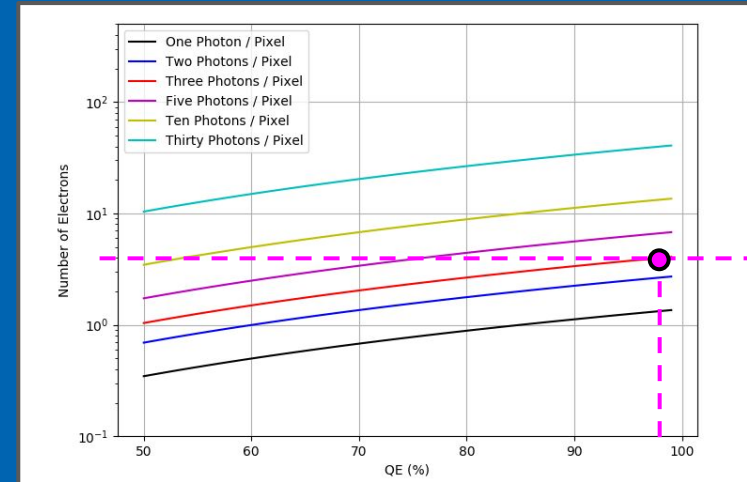
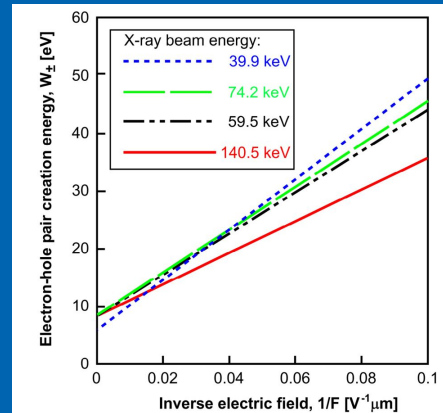

Synthesizing some of the numbers

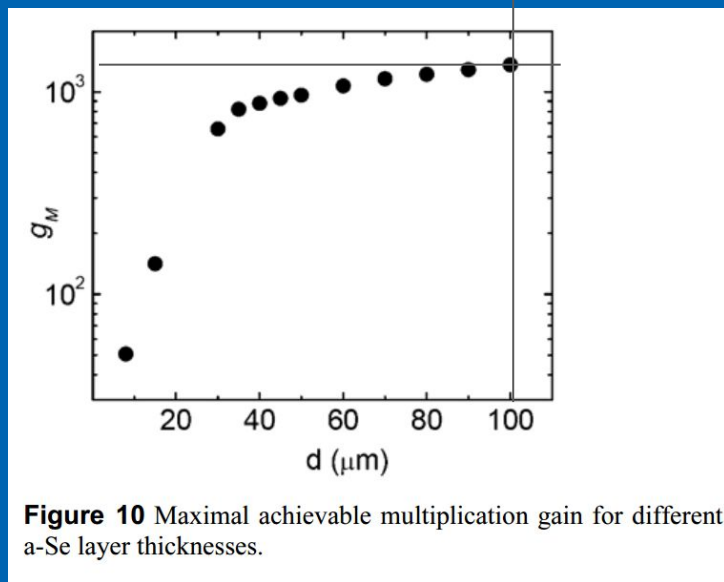
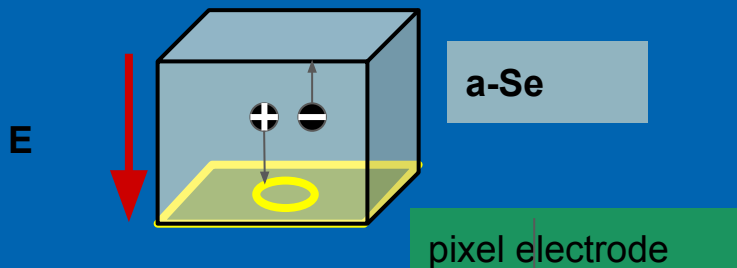

I can achieve a 99% Quantum Efficiency for 128 nm photons with a a-Se layer that is >1 micrometers thick

If 3 photons fall on the 4mm pad this will give me ~3 electron-hole pairs (*note: I've assumed every photon gives only one electron-hole pair*)

@90 Volts/micrometer (the theoretical breakdown voltage of a-Se that is 100 micrometers thick) This will give me a maximum achievable gain factor of $\sim 10^3$

So, you will get ~4000 electrons for three 128nm photons on a 4mm pixel pad

These numbers would be very consistent with the current Q-Pix design choice of being between 0.3 and 1 fC (1800 and 6000 electrons) for an RTD

Amorphous Selenium for Q-Pix

- Some open thoughts I have:

- This looks promising if you could use a cheap method of fabrication and adherence of a thin film of doped a-Se to a PCB board would allow for electrons to be liberated and guided to a pixel button.
- Could use field shaping electrodes and grounded (biased?) pixel buttons
 - Question about the necessary field for good detection that I am still trying to work out (some of the reading seems to suggest $\sim V/\mu\text{m}$...which seems hard)
- There is also literature suggesting with a little engineering you can achieve avalanche in these detectors ([see paper here](#)) around $80 \text{ V}/\mu\text{m}$ increasing the viability of this as a photon detector

a-Se Layer

PCB

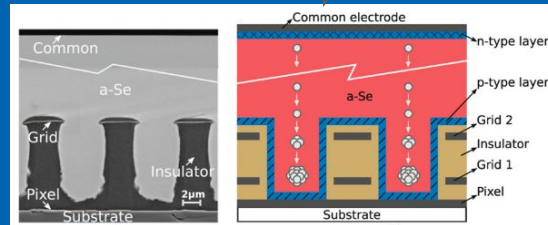
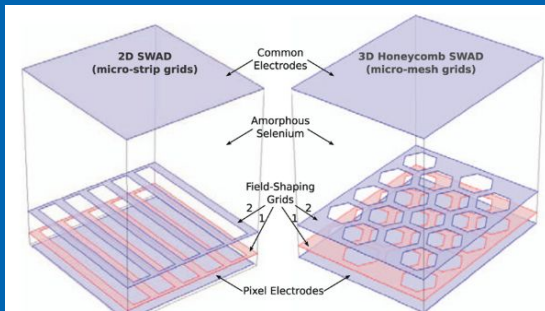
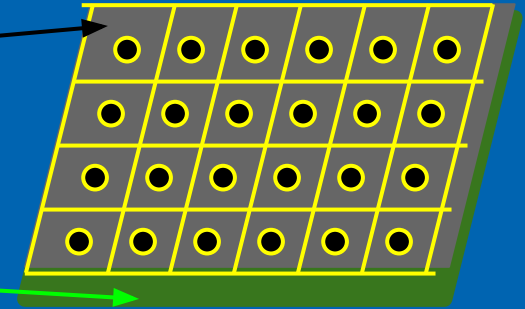

Conclusions

- Readout requirements for kiloton scale LArTPC's offer many challenges to fully exploit the rich data they have to offer
 - **We must optimize for discovery!!!**
- Low threshold pixel based readout can optimize for discovery the impact of these detectors
 - **Requires an unorthodox solution**
- The Q-Pix concept may afford a way to pixelize a kiloton scale LArTPC and retain all the details of data
 - The devil lives in the details, but an effort is underway with promising preliminary results
 - Stay tuned for more updates!



*Q-Pix consortium would like to thank
the DOE for its support via
DE-SC0020065 award*

Backup Slides

Electron - Hole Pair creation

The minimum amount of energy absorbed by the incident radiation that is needed to create a single EHP is termed EHP creation energy $W_{0\pm}$ and determines the intrinsic sensitivity of the material used as a radiation detection medium. $W_{0\pm}$ is also called the ionization energy of the medium. The photogeneration efficiency η can be redefined as the fraction of EHPs which do not recombine relative to all EHPs created by an incident photon. The latter definition is better suited for a photogeneration process initiated by an x-ray or a gamma-ray (thousands of EHP created by a single photon).

The average energy W_{\pm} per freed EHP (EHP that escapes recombination and can be potentially successfully collected) is given by

$$W_{\pm} = \frac{W_{0\pm}}{\eta}. \quad (2.9)$$

The amount of energy ΔE absorbed by the material from the radiation and the electric charge ΔQ that can be are related by the quantity W_{\pm} through

$$\Delta Q = q \frac{\Delta E}{W_{\pm}}, \quad (2.10)$$

where q is the charge of the electron.

Typically $W_{0\pm}$ increases with the bandgap E_g of the photoconductor and for crystalline semiconductors it follows the Klein rule [81]

$$W_{0\pm} \approx 2.8 E_g + \varepsilon_{\text{phonons}}, \quad (2.11)$$

where $\varepsilon_{\text{phonons}}$ is a phonon energy term that involves multiple phonons. For amorphous semiconductors as suggested by Que and Rowlands [82], the relaxation of conservation of momentum rule leads to

$$W_{0\pm} \approx 2.2 E_g + \varepsilon_{\text{phonons}}. \quad (2.12)$$

However, W_{\pm} in a-Se, as in a number of other low-mobility solids, depends both on the applied field F and energy E of the incident photons because the photogeneration efficiency η supposedly depends on both of these quantities. There have been numerous experiments, with a wide range of conflicting results devoted to measuring W_{\pm} in a-Se as a function of applied electric field and the energy of the incident photons. One of the most recent and most detailed experimental works is due to Blevis et al. [83]. In the latter work the authors have used various monoenergetic photon sources and have clearly shown that W_{\pm} depends on both energy of the incident photons and on the applied electric field across the a-Se layer. However, even that set of experimental data is not complete because the dependence of W_{\pm} on temperature has not been investigated.

[83] I. Blevis, D. Hunt, J. Rowlands, "Measurement of x-ray photogeneration in amorphous selenium", Journal of Applied Physics, 85, pp. 7958-7963, 1999
Need this reference!

The usual way to find $W_{0\pm}$ from W_{\pm} versus electric field F data is to extrapolate to infinite electric field plotting W_{\pm} vs $1/F$. Part of the data of Blevis et al. [83] replotted in that way is presented in Figure 2.11. Although the lines corresponding to different x-ray photon energies have different slopes they all converge to $W_{0\pm}$ in the range 6-8 eV and that value is relatively independent from the energy of the incident photons. Previous measurements by Kasap and coworkers have resulted in $W_{0\pm} \approx 6$ eV for x-ray beams with average energies in the range of 32-53 keV [84]. Application of Klein rule with $E_g = 2.22$ eV and $0.5 \text{ eV} \leq \varepsilon_{\text{phonons}} \leq 1.0 \text{ eV}$ (the latter taken from [81]) gives $6.71 \text{ eV} \leq W_{0\pm} \leq 7.16 \text{ eV}$ whereas Que and Rowlands rule gives $5.38 \text{ eV} \leq W_{0\pm} \leq 5.89 \text{ eV}$. The scatter in the existing experimental data makes very difficult

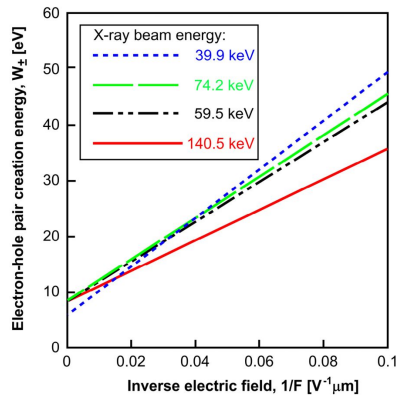

$$\Delta Q = q \frac{\Delta E}{W_{\pm}}, \quad W_{\pm} = \frac{W_{0\pm}}{\eta}.$$

So we'll assume $W_{0\pm}$ is 7 eV and the quantum efficiency is 99% giving $W_{\pm} = 7.07$ eV

Amorphous Selenium as a UV-Photon Detector

- In the last 6'ish years there has even been some considerable development in using a-Se for direct photon detection in the UV range

A transparent ultraviolet triggered amorphous selenium p-n junction

Appl. Phys. Lett. **98**, 152102 (2011); <https://doi.org/10.1063/1.3579262>

Ichitaro Saito^{1,a)}, Wataru Miyazaki², Masanori Onishi², Yuki Kudo³, Tomoaki Masuzawa², Takatoshi Yamada⁴, Angel Koh⁵, Daniel Chua⁵, Kenichi Soga¹, Mauro Overend¹, Masami Aono⁶, Gehan A. J. Amaratunga¹, and Ken Okano²

- **This paper even reports** “an amorphous selenium (a-Se) film p-n junction fabricated through an inexpensive and simple process of thermal evaporation and electrolysis”
 - Looking at light using a D2 lamp (100 - 400 nm) with an irradiance of $\sim 3 \text{ mW/m}^2$ at 254 nm

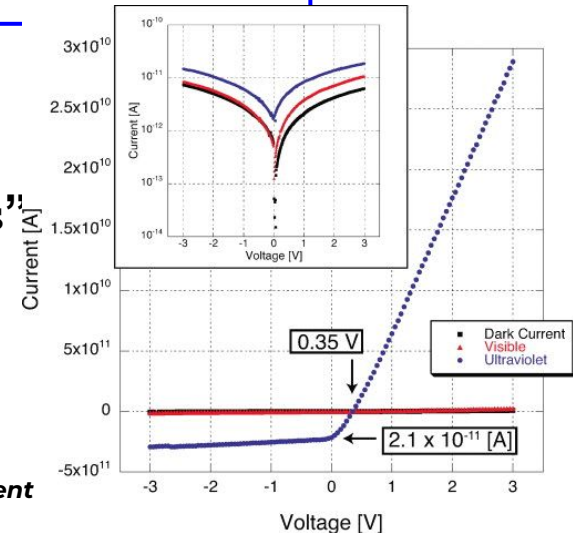

I-V characteristics of the dark current, photocurrent in the visible range, and the photocurrent in the UV range. The inset is the semilog plot of the I-V characteristics before electrolysis.

Amorphous Selenium for Q-Pix

- Some open thoughts I have:

- This looks promising if you could use a cheap method of fabrication and adherence of a thin film of doped a-Se to a PCB board that would allow for electron to be liberated and guided to a pixel button.
- Could use field shaping electrodes and grounded (biased?) pixel buttons
 - Question about the necessary field for good detection that I am still trying to work out (some of the reading seems to suggest $\sim V/\mu\text{m}$...which seems hard)
- There is also literature suggesting with a little engineering you can achieve avalanche in these detectors ([see paper here](#)) around $80 \text{ V}/\mu\text{m}$ increasing the viability of this as a photon detector

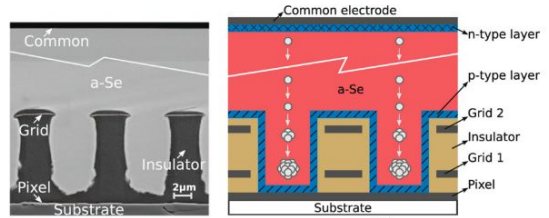
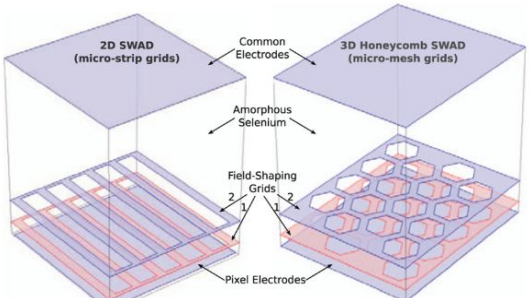
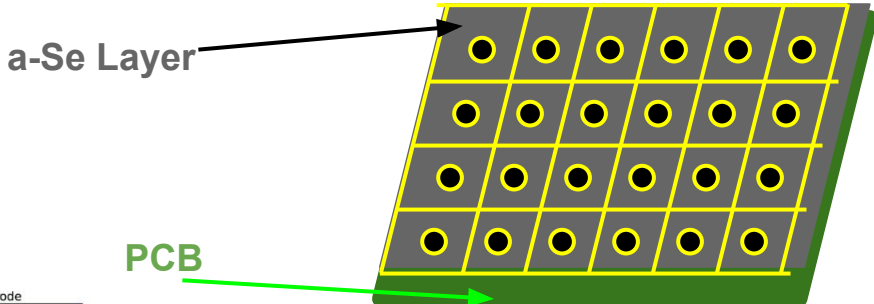

Amorphous Selenium for Q-Pix

- Things look interesting enough (to me) that myself and a student are going to spend some amount of brain/simulation time trying to come up with a realistic model of what we would expect to see from scintillation light in liquid argon
- I've identified a few commercial companies to talk to about manufacturing, samples, doping, adhesion, etc
 - e.g. Hologic Inc., Varex, Canon, etc...
- Any input into what we should be thinking about, trying to calculate, and model is greatly appreciated! (any additional collaboration is also welcome!)
- Some relevant papers
 - [Useful thesis with solid state theory for a-Se](#)
 - [2013 historical review of a-Se photon detectors](#)
 - [UV \(200 - 400 nm\) a-Se detector](#)
 - [VUV \(100 - 400 nm\) a-Se detector](#)
 - [Field shaping multi-well avalanche a-Se detectors](#)
 - [MC method for photon counting in a-Se detectors](#)

Point of the plot

- **Trying to show the number of events recorded by detector for assuming one year of fiducial mass**
 - Detector 1: DUNE Liquid Argon Near Detector (147 Tons of Argon)
 - Detector 2: DUNE Far Detector (10 kT of Argon)
- **DUNE has to be sensitive to a wide range of energies to do the physics it wants to do!**
 - The near detector is driven by the beam physics
 - The far detector has a really broad range of energies and more low energy things it wants to be sensitive to
- **Emphasize that the rates of the events in one year of data taking is very different between the near and far detector**
 - Every event in the far detector is precious!
 - Can come from a wide range of energies, topologies, and sources!

Scale of the detectors

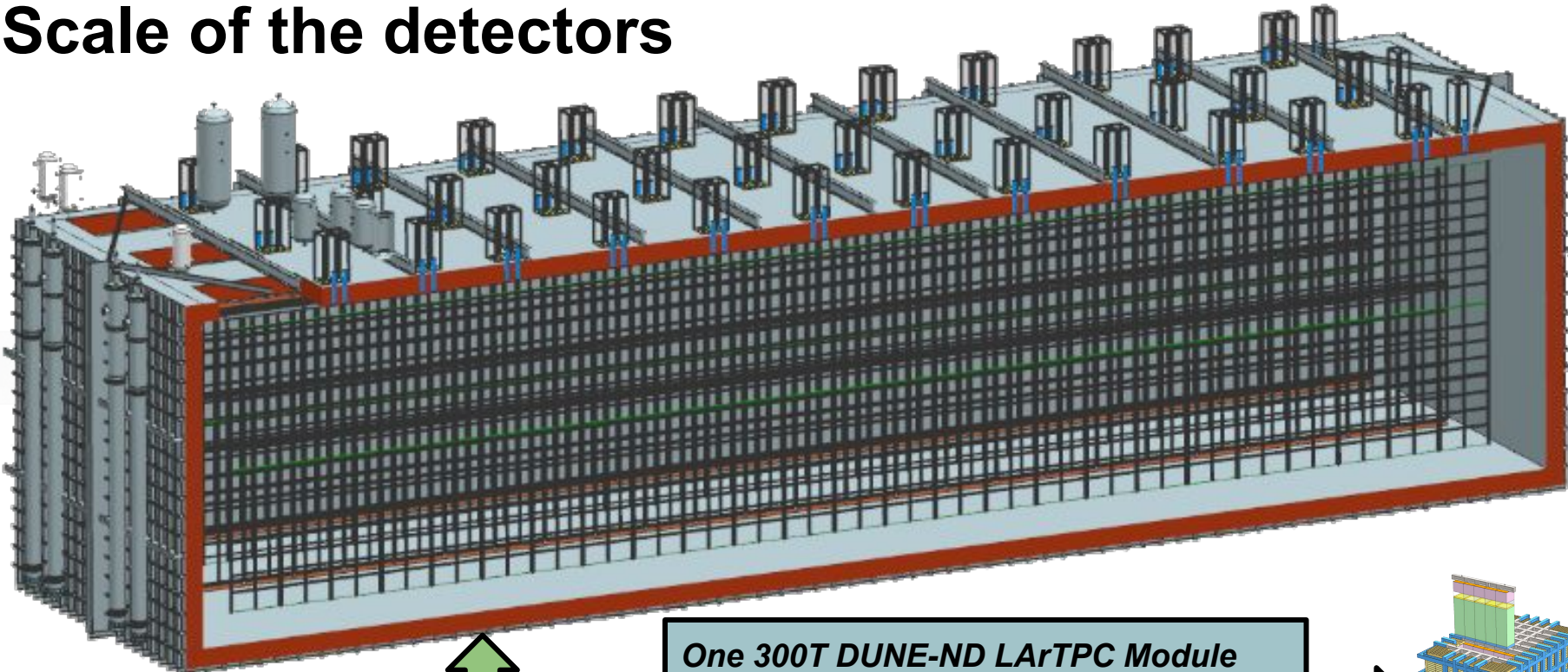

One 10kT DUNE LArTPC Module (18 m x 19 m x 66 m)
¼ the total size of DUNE



One 300T DUNE-ND LArTPC Module (11m x 8 m x 7 m)
⅓ of the DUNE Near Detector

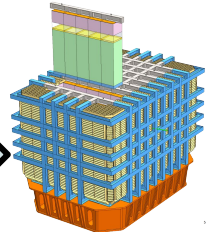
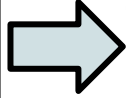

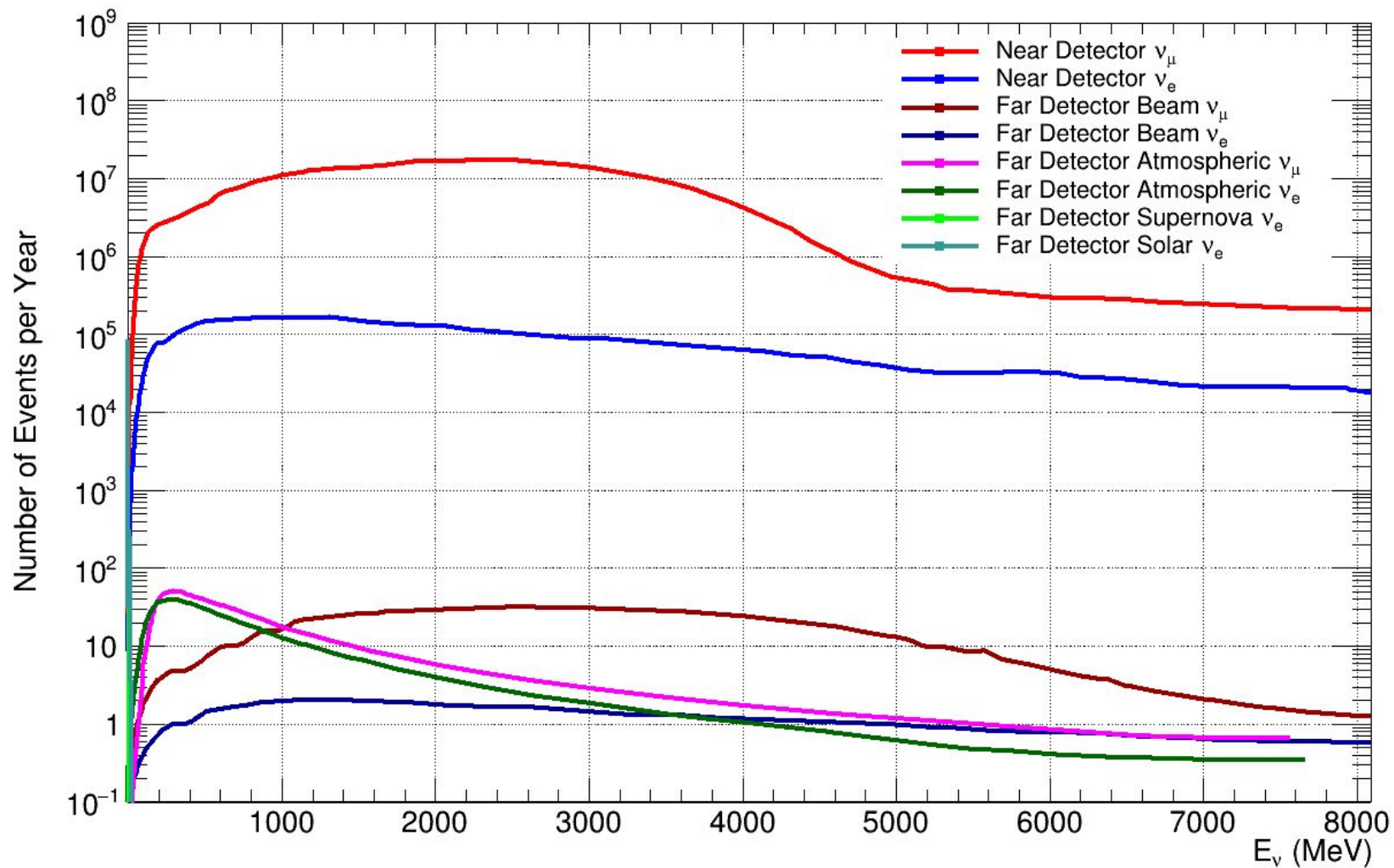

Everything here
in a linear x-axis

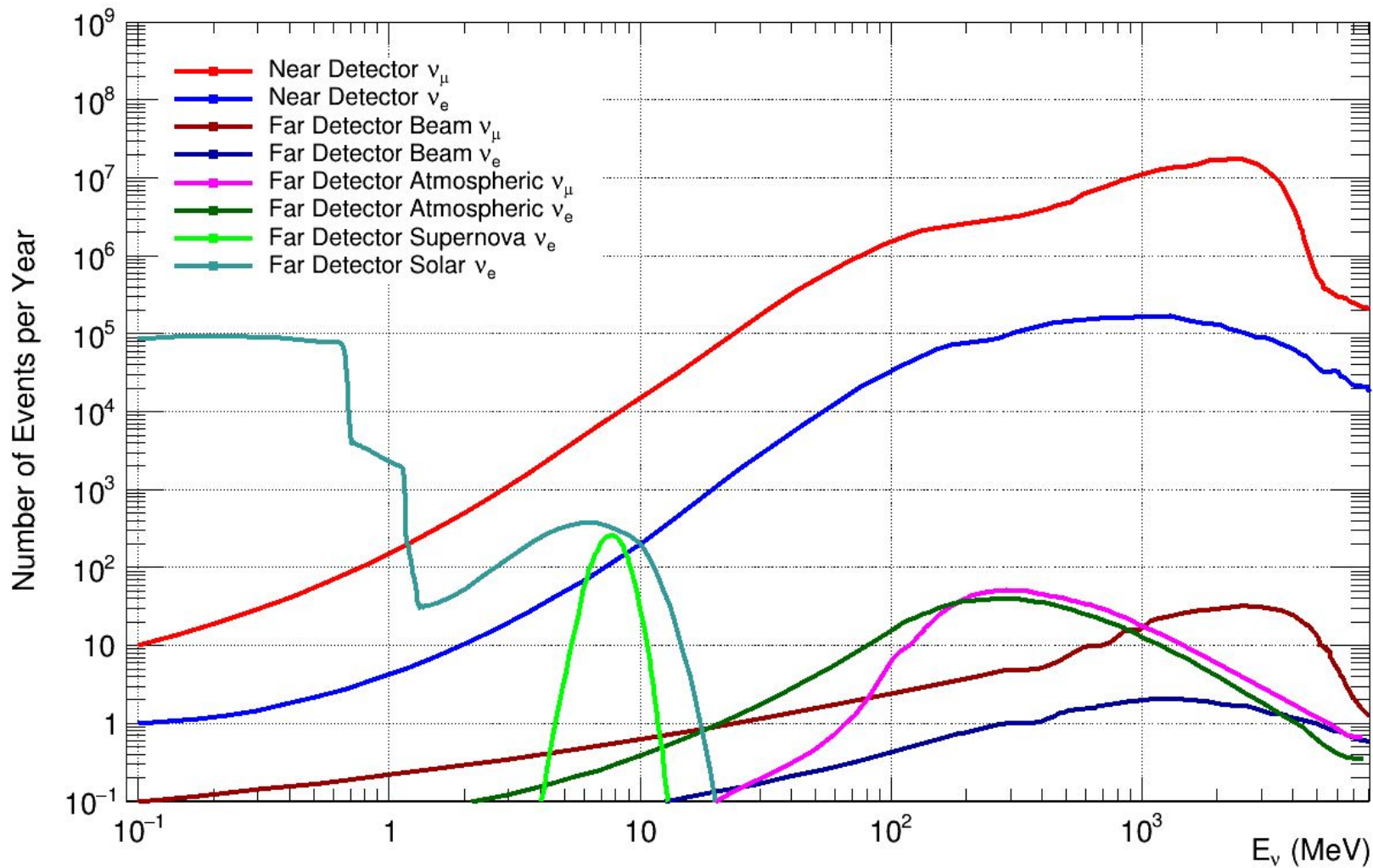

Everything h
in a log x-axis

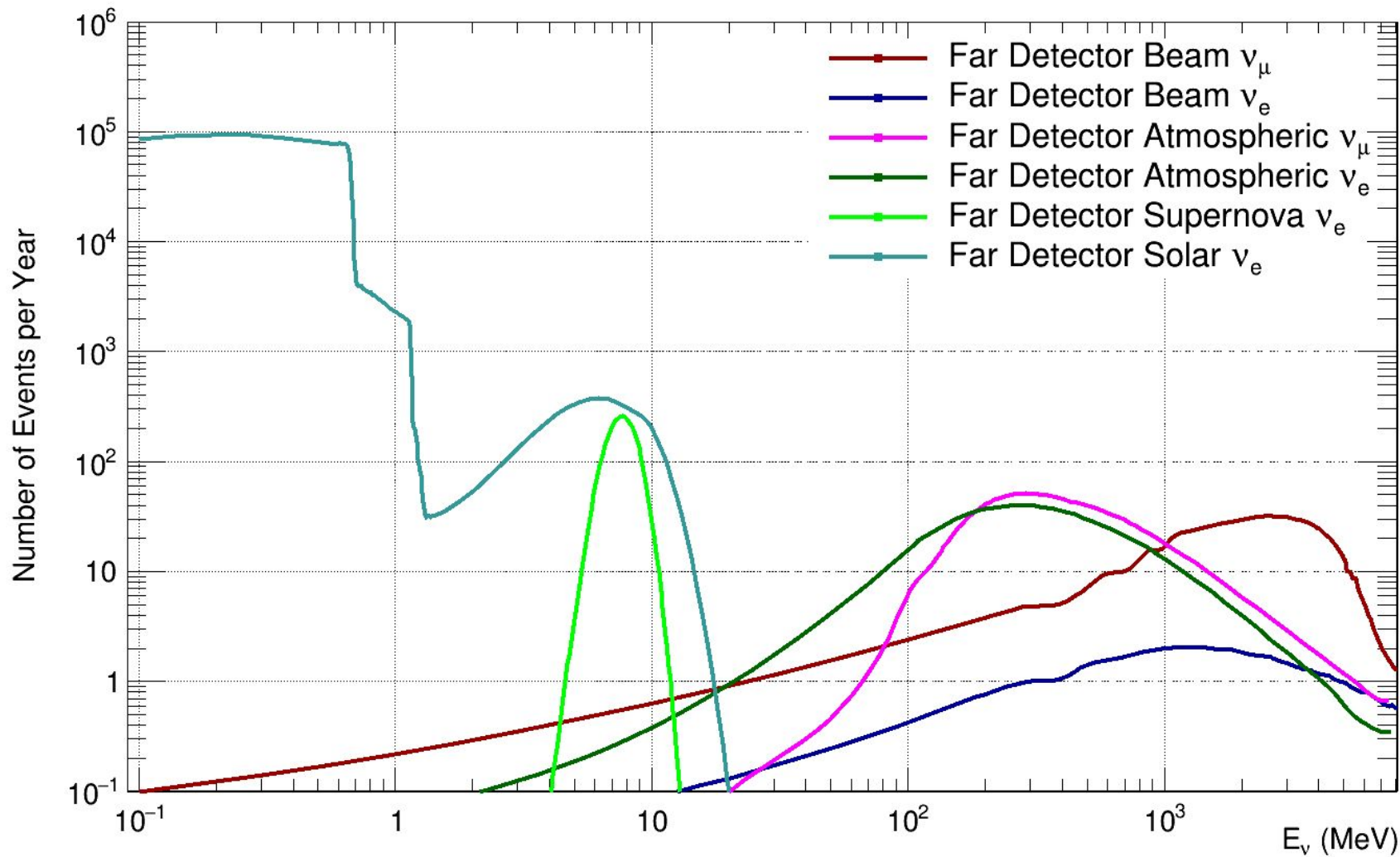

Just the detector