

LLRF model-based commissioning tools and operational insights

C. Rivetta, D. Van Winkle, T. Mastorides, J.D. Fox¹
P. Baudrenghien, A. Butterworth, J. Molendijk²

¹AARD-LLRF Group, SLAC

²AB-RF Group, CERN

Outline

- 1 Introduction
- 2 LLRF Configuration Tools
 - General Description
 - Features and Operation
- 3 Results and future work

Outline

- 1 Introduction
- 2 LLRF Configuration Tools
 - General Description
 - Features and Operation
- 3 Results and future work

RF Station / Beam Dynamics Interaction

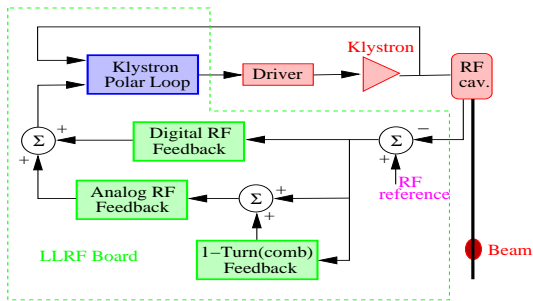

- The longitudinal beam dynamics is mainly defined by the impedance and associated circuitry of RF stations.
- The stable operation requires the control of higher-order mode impedances as well as **the precise control of the accelerating fundamental impedance.**
- Impedance controlled LLRF architectures modify the impedance seen by the beam with feedback techniques. This system has multiple dynamic loops.
- Stability of the operation point of the complete system is a necessary condition.

LHC LLRF Effort

RF station / Longitudinal beam dynamics effort is combined in two related activities

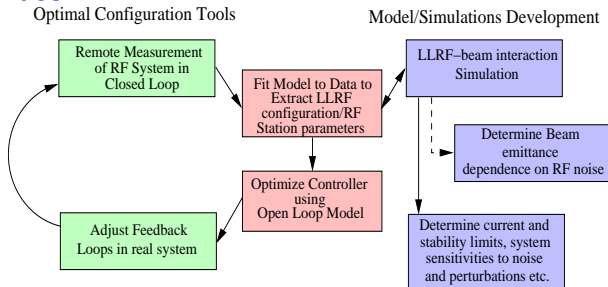

- Configuration Tools: Identifies the RF station model and defines the LLRF adjustable parameters to minimize the overall RF station impedance.
- Model/Simulation Development: Detailed model of both the RF station and the longitudinal beam dynamics. Impact of RF station operation configuration on the longitudinal beam dynamics.
- Common Area: RF station model and model-based design of the LLRF.

Motivation

- Over the last two years with LARP support, SLAC personnel have established a strong collaboration with CERN AB-RF group, and have successfully developed a suite of tools to configure the LHC RF stations in operation, to help in setting up the stations after a down time, and to determine deviations between the nominal and measured system behavior (drift).
- These tools operate remotely and allow identifying the RF station transfer function and designing the feedback loops using model-based techniques.
- Remote operation was crucial under the new stricter CERN polices preventing tunnel access when the magnets are energized.

Outline

- 1 Introduction
- 2 LLRF Configuration Tools
 - General Description
 - Features and Operation
- 3 Results and future work

Outline

- 1 Introduction
- 2 **LLRF Configuration Tools**
 - **General Description**
 - Features and Operation
- 3 Results and future work

Main Features of the Tool

- Adjust off-set voltages in the analog LLRF and modulator circuitry
- Adjust phase rotation between digital and analog parallel paths in the LLRF boards.
- Set parameters of circuitry compesating the effects of klystron spurious resonance in the RF loop.
- Measurement of the open loop transfer function of the RF station.
- Measurement of the closed loop transfer function of the RF station.
- Measurement and Configuration of the klystron polar loop.
- Based on the identified open loop model of the RF station, the closed loop system is designed by defining the adjustable parameters of the LLRF to minimize the impedance of the RF station.

LHC LLRF Tools

Built-in Network Analyzer

- The built-in Network Analyzer operates by injecting a base-band complex noise sequence and measuring the complex signal response of the circuit to that excitation.
- The transfer function between the injection and measurement points is estimated as the quotient between the cross power spectral density of both signals and the power spectral density of the input signal.
- To obtain a mathematical model of the system, the measured transfer function is parameterized by fitting the transfer function of a lineal model representative of the system.

Outline

- 1 Introduction
- 2 LLRF Configuration Tools
 - General Description
 - Features and Operation
- 3 Results and future work

LHC LLRF Tools

LLRF circuitry adjustments

- Adjust off-set voltages
- Adjust phase rotation between LLRF digital and analog paths.

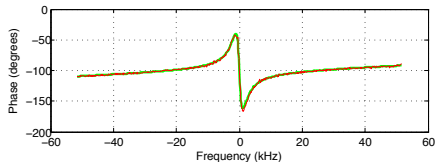
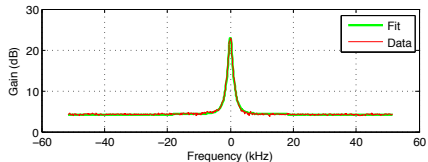
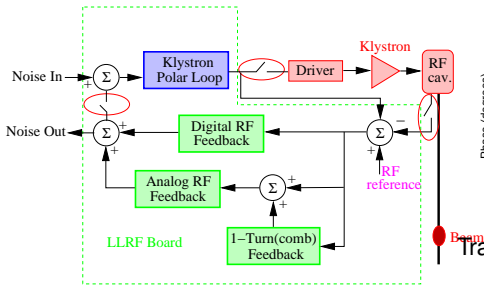

Transfer function LLRF board St. 5, beam 1

LHC LLRF Tools

LLRF circuitry adjustments

- Calibration of klystron spurious resonance compensator (Notch circuit).

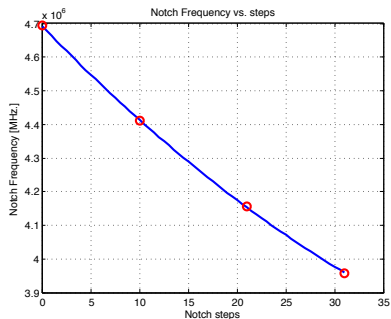
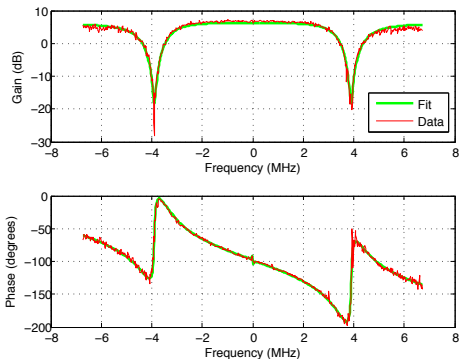

Transfer function LLRF board St. 5, beam 1

LHC LLRF Tools

Compensation the effects of klystron spurious resonance in the RF loop

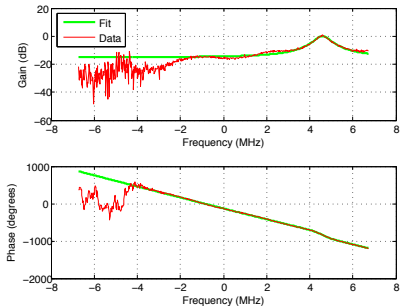

Selected Notch step for klystron bump compensation

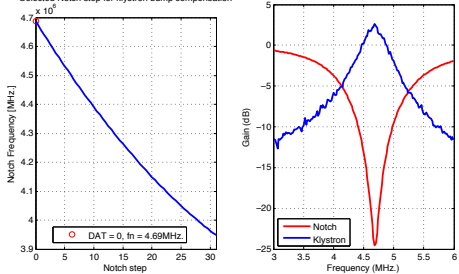

Transfer function Klystron St. 1, beam 1

LHC LLRF Tools

Measurement of the Open Loop Transfer Function

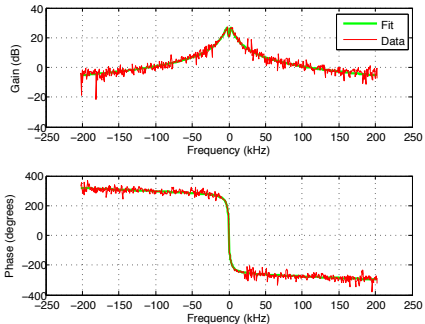
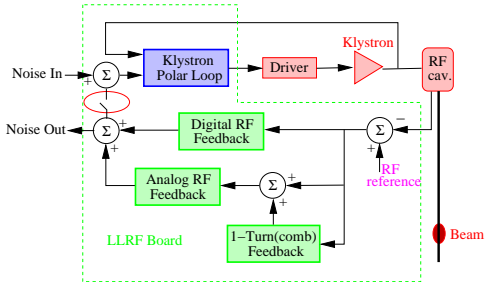

Transfer function RF station 2, beam 2

LHC LLRF Tools

Measurement of the Closed Loop Transfer Function

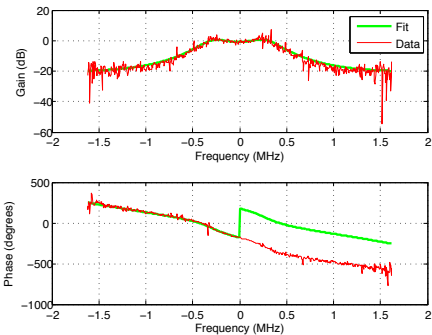
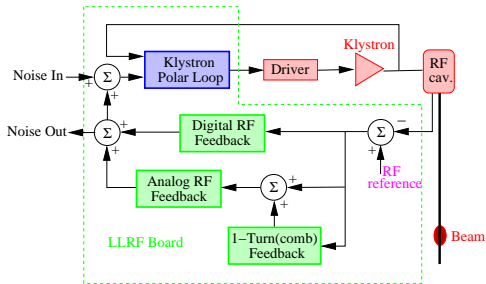

Transfer function RF station 1, beam 1

LHC LLRF Tools

Measurement of the Open Loop / Closed Loop Transfer Functions including the 1-turn delay filter (Comb)

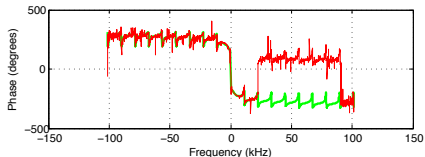
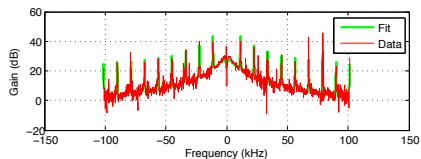

Transfer function RF station 1, beam 2

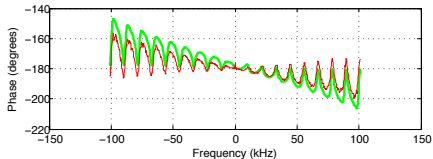
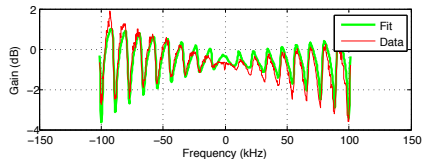

Transfer function RF station 2, beam 2

LHC LLRF Tools

Model-Based design tools

- Based on the mathematic model estimated, the tool calculates the magnitude of the adjustable parameters in the LLRF control to configure the feedback loops of the RF station.
- The parameter adjusted are: **gain and phase in the direct loop**, **gain, delay in the 1-turn delay filter** and **gain and phase polar loop**.

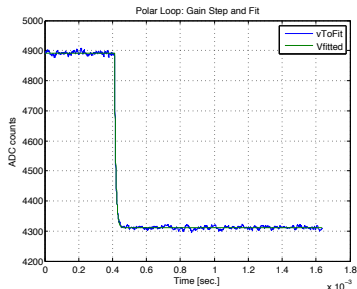
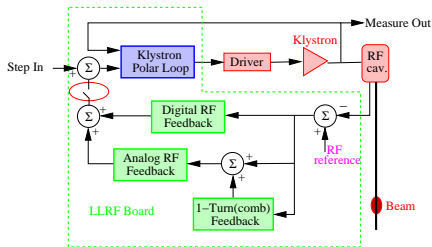

e.g. Adjustment of the gain in the polar loop using step function

LHC LLRF Tools

Model-Based design tools

- Example of calculation and adjustment of the gain and phase in the direct loop
- Measurement of the RF station transfer function...

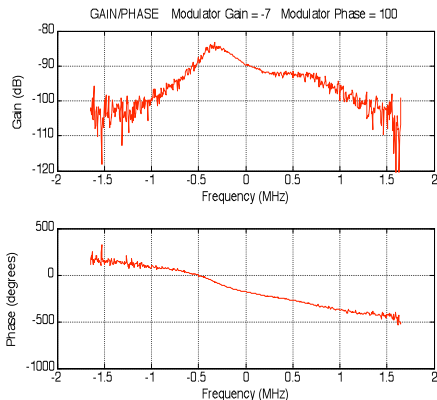

LHC LLRF Tools

Model-Based design tools

- Calculation of the optimal closed-loop transfer function and LLRF parameters (gain and phase in direct loop)....

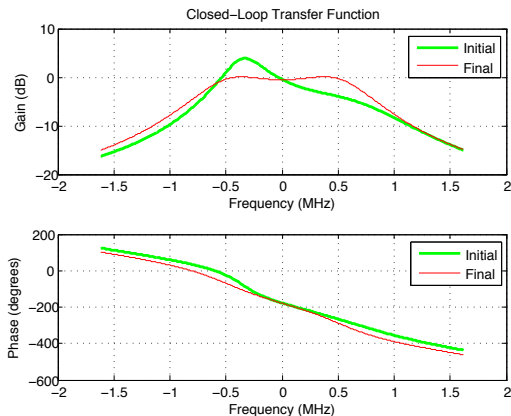

LHC LLRF Tools

Model-Based design tools

- Set the suggested gain and phase parameters in the LLRF board

....

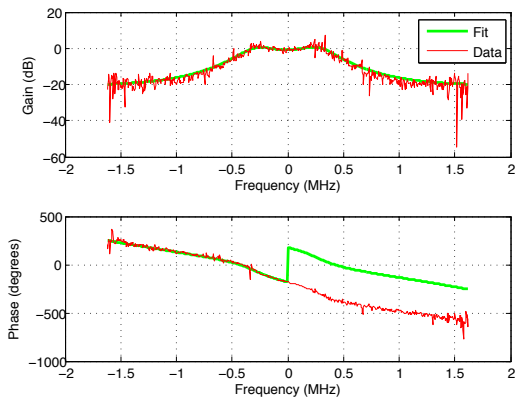

Outline

- 1 Introduction
- 2 LLRF Configuration Tools
 - General Description
 - Features and Operation
- 3 Results and future work

Results and future work

- LLRF configuration tools have been useful to the CERN AB-RF group to set up remotely the feedback loops of the RF stations during start up in November 09 / February 10.
- Crucial to reduce the impact in the RF system start-up and operation of the new CERN police restricting the access to the underground caverns.
- The configuration tool allows setting the feedback loop in the RF station to obtain
 - $Z_{RFstation} = 45K\Omega$ uniformly for all RF station (all Q_L 's).
 - x10 extra reduction in $Z_{RFstation}$ at synchrotron sideband with the 1-turn delay filter.
 - Reduction of low frequency spurious signals of klystron power supply (more than 30dB, $f = 50 \text{ Hz} - 3\text{KHz}$)
- It takes a few minutes to set the complete feedback loop per station.

Results and future work

- From November 09 to February 10, the tools were crucial to design calibration curves to adapt the gain and phase of the direct loop to compensate the change in cavity's Q_L during operation (coupler moves, $Q_L = 20K$ injection, $Q_L = 60K$ physics).
- **Future Plans**
- During FY2010, finish commissioning of 1-turn delay feedback configuration tool in all the LHC RF stations. Tested in RF station prototype and one LHC station.
- Follow with studies relating to longitudinal beam dynamics and RF station configuration and parameters
- More details in "LLRF studies at LHC - models, anticipated beam dynamics and emittance effects" Accelerator systems session.

Acknowledgments

- We would like to thank the CERN AB-RF group for their help, support, interest, and hospitality in all phases of this project. We have been grateful for their help and continuous participation during our visits and the development of these tools
- We would also like to thank the SLAC Accelerator Research Division for their support and help
- This work is supported by the US-LARP program and DOE contract #DE-AC02-76SF00515
- Thanks to the audience.....Questions?,