

Search for standard model Higgs boson in the di-photon final state at Tevatron

Xuebing Bu

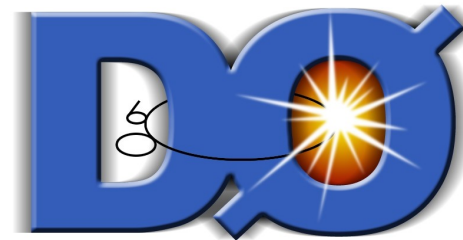

On behalf of the CDF&DØ collaborations



Outline

- Motivation
- $H \rightarrow \gamma\gamma$ search at CDF
- $H \rightarrow \gamma\gamma$ search at DØ
- Combined results
- Conclusion



Motivation

- Di-photon production:
- Search for new phenomena
 - Search for Higgs boson
 - $M_H > 114.4 \text{ GeV}$ (LEP)
 - Exclusion $M_H = 145\text{-}216 \text{ GeV}$ (CMS)
 - Contributes to the Tevatron combination in the intermediate mass region (110-140 GeV)
 - Golden channel at LHC

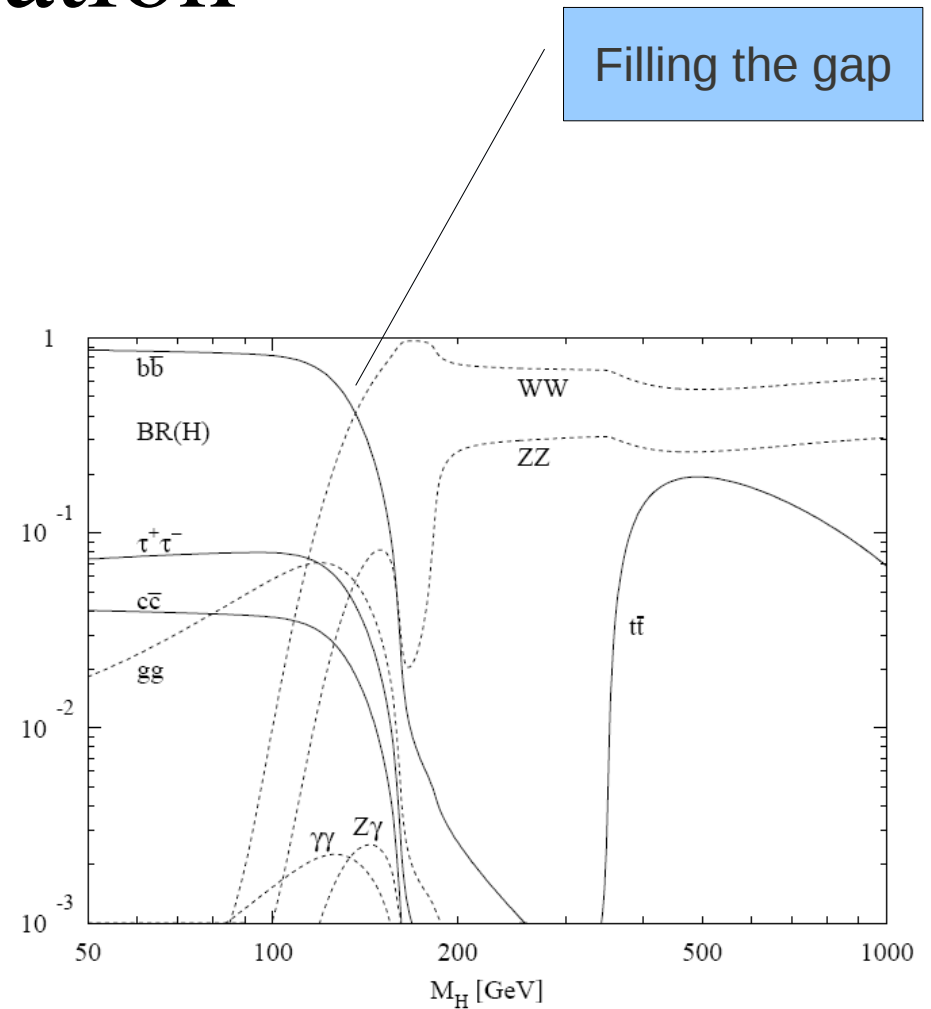

SM Higgs production

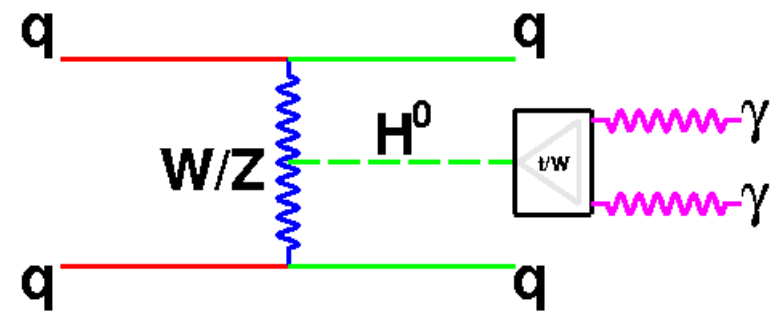
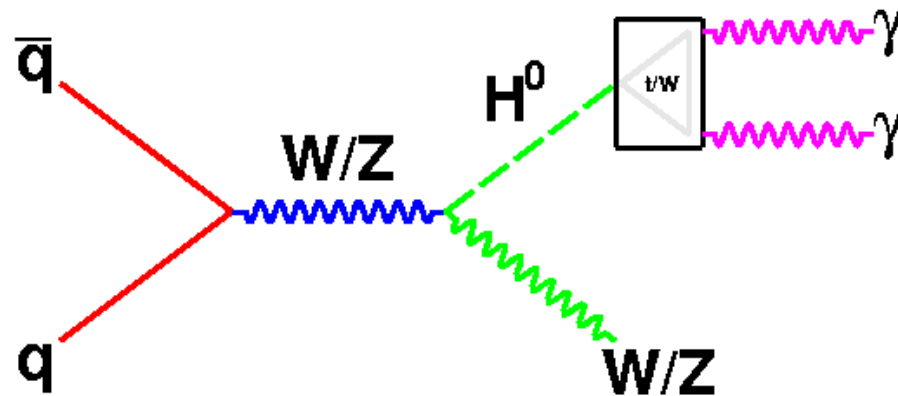
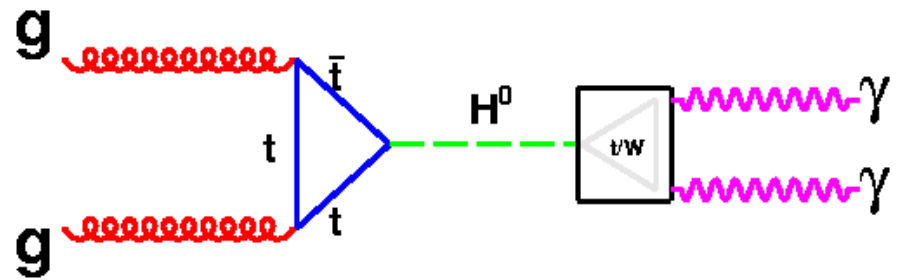



$H \rightarrow \gamma\gamma$ search at CDF



Event selection

- Transverse energy > 15 GeV
- $M_{\gamma\gamma} > 30$ GeV
 - **Central photon**: $|\eta| < 1.05$, neural based ID
 - **Plug photon**: $1.2 < |\eta| < 2.8$, isolated EM shower
 - **Central conversion photon**: select a primary central electron with a colinear, oppositely signed track ($p_T > 1$ GeV) nearby, both of them point to the same $p_T > 15$ GeV EM cluster.
 - Plug conversion photon is not considered due to the lower tracking efficiency



Acceptance

Production Process	M_H (GeV/ c^2)	Signal Acceptances (%)			
		CC	CP	CC Conv	CP Conv
ggH	100	12.0	15.8	2.7	1.8
	105	12.1	15.9	2.8	1.8
	110	12.2	16.2	2.7	1.8
	115	12.4	16.2	2.8	1.8
	120	12.5	16.3	2.9	1.9
	125	12.6	16.3	2.9	1.8
	130	12.7	16.3	2.9	1.8
	135	12.9	16.2	2.9	1.8
	140	13.0	16.3	2.9	1.8
	145	13.3	16.3	2.9	1.9
150	13.3	16.2	3.0	1.8	

- CC: two central photons
- CP: central + forward photons
- CC Conv: central + central converted photons
- CP Conv: central converted + forward photons

Background modeling



- Not necessary for dedicated searches for a narrow mass peak.
- Therefore, rather than model each background component directly, a null hypothesis is assumed - after visual confirmation that no significant peak exists in the data, a smooth curve is fit to the data. This fit excludes a **12 GeV window** around each mass point and is then interpolated into the signal region.

Background modeling

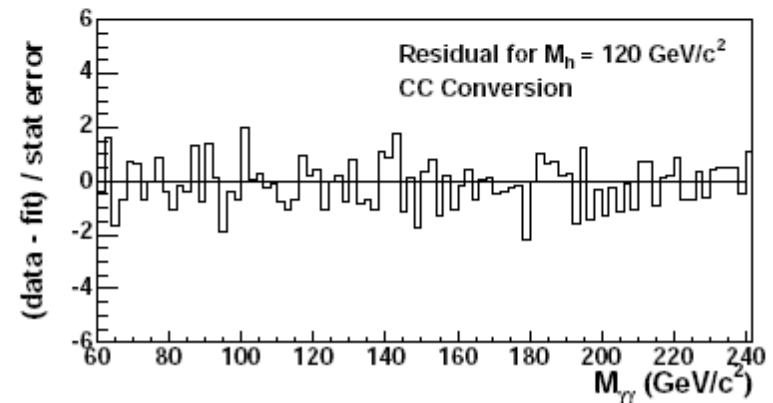
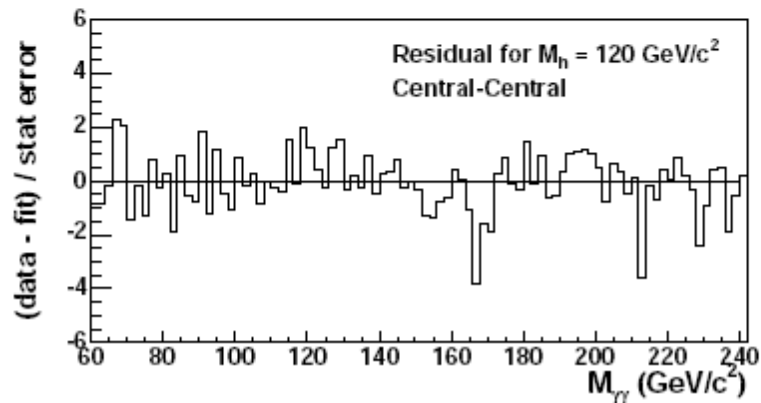
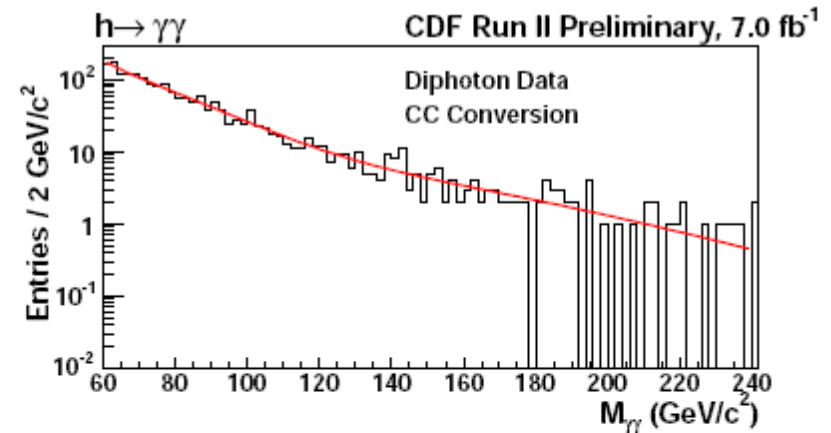
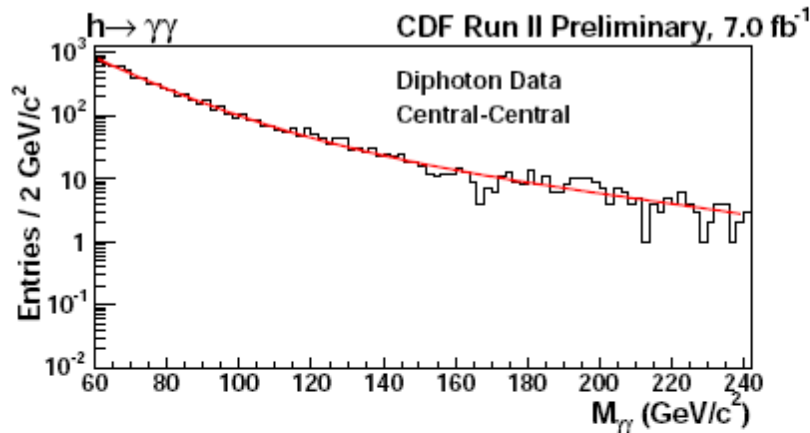

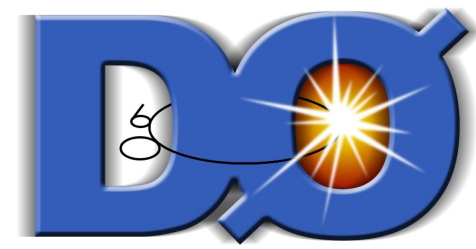

$H \rightarrow \gamma\gamma$ search at DØ

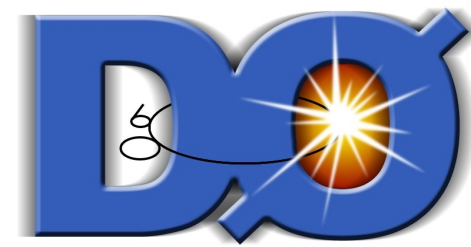

Event selection

- Transverse energy > 25 GeV
- $M_{\gamma\gamma} > 30$ GeV
 - **Central photon**: $|\eta| < 1.1$, isolated EM shower, $NN > 0.1$, not matched with a track or a pattern of the hits along the EM trajectory

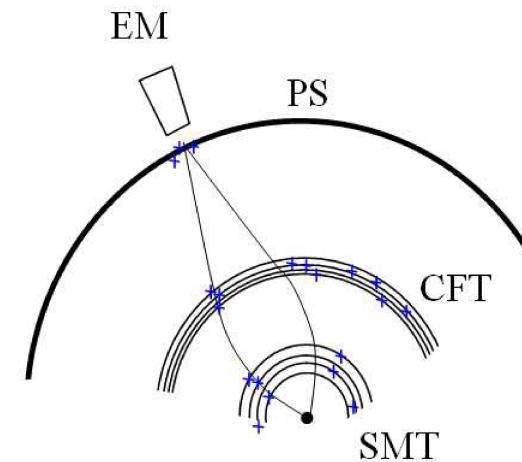
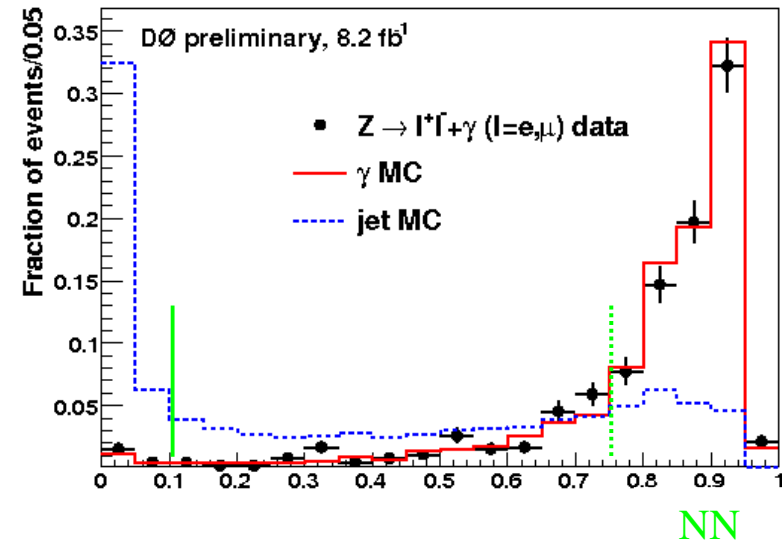

Background Modeling

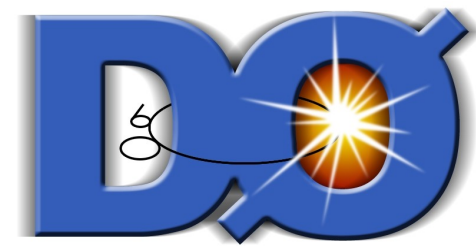

1. $Z/\gamma^* \rightarrow ee$, both electrons are misidentified as photons, estimated with Geant MC;
2. **Non- $\gamma\gamma$** (γ +jet, jet+jet), when the jet(s) is(are) misidentified as the photon(s), estimated from data using 4x4 matrix method;
3. **Direct $\gamma\gamma$** , the irreducible background, estimated from sherpa full MC.

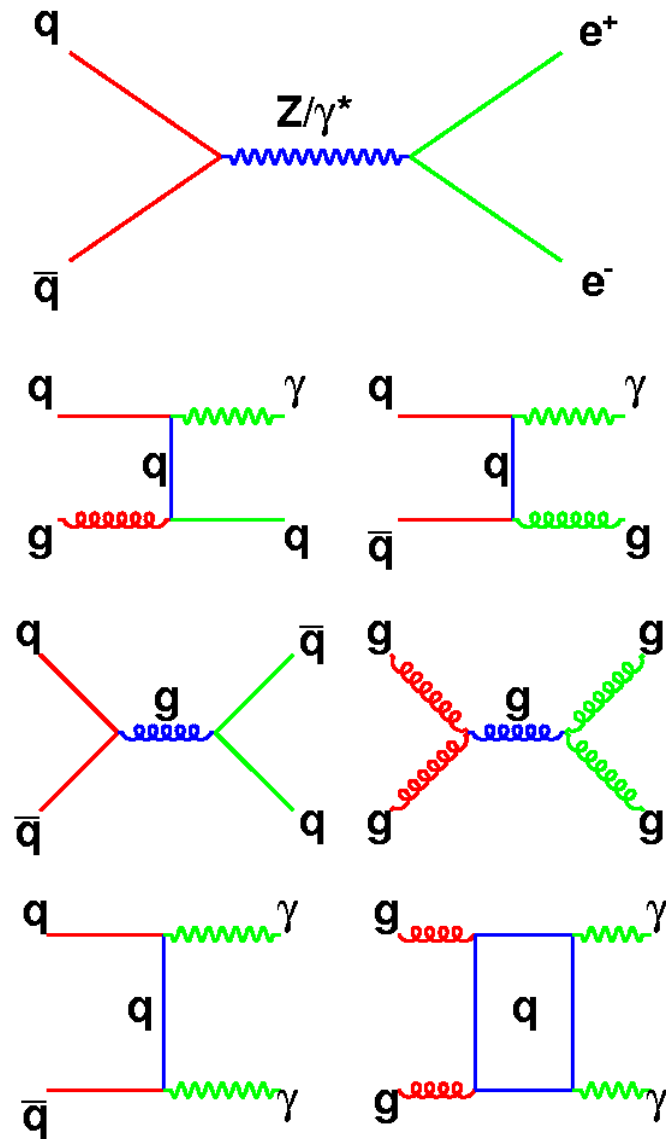

Background Modeling

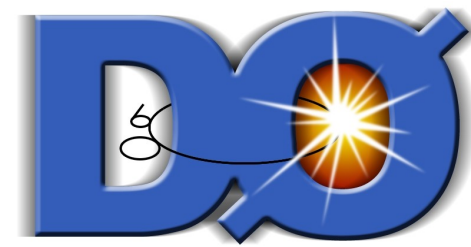

- direct $\gamma\gamma$

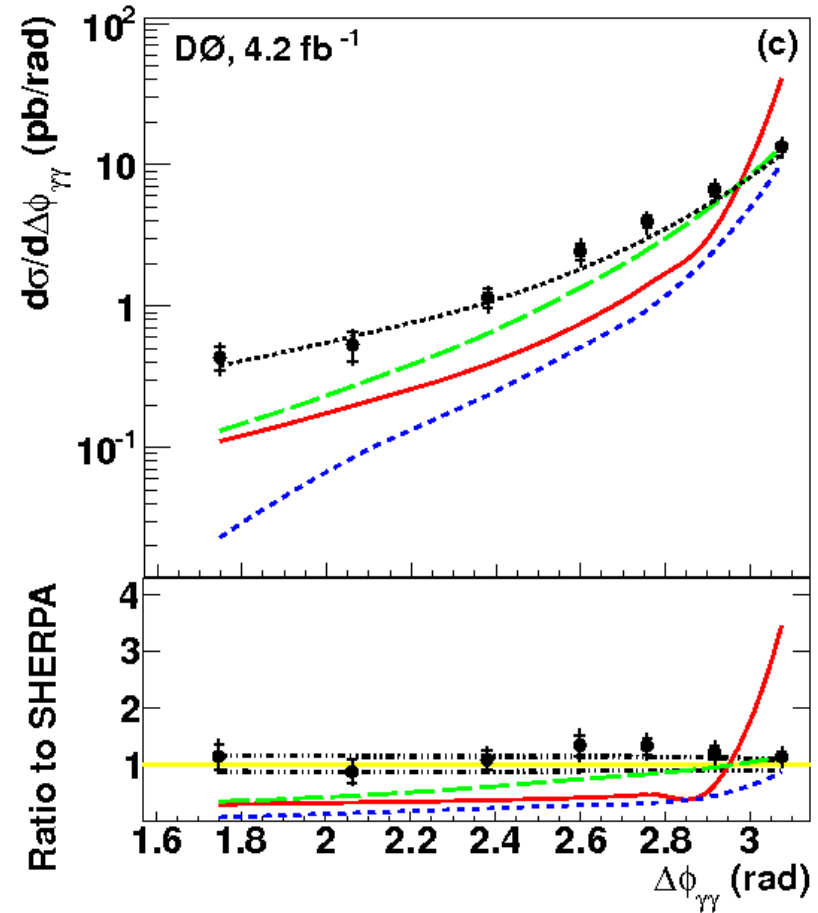
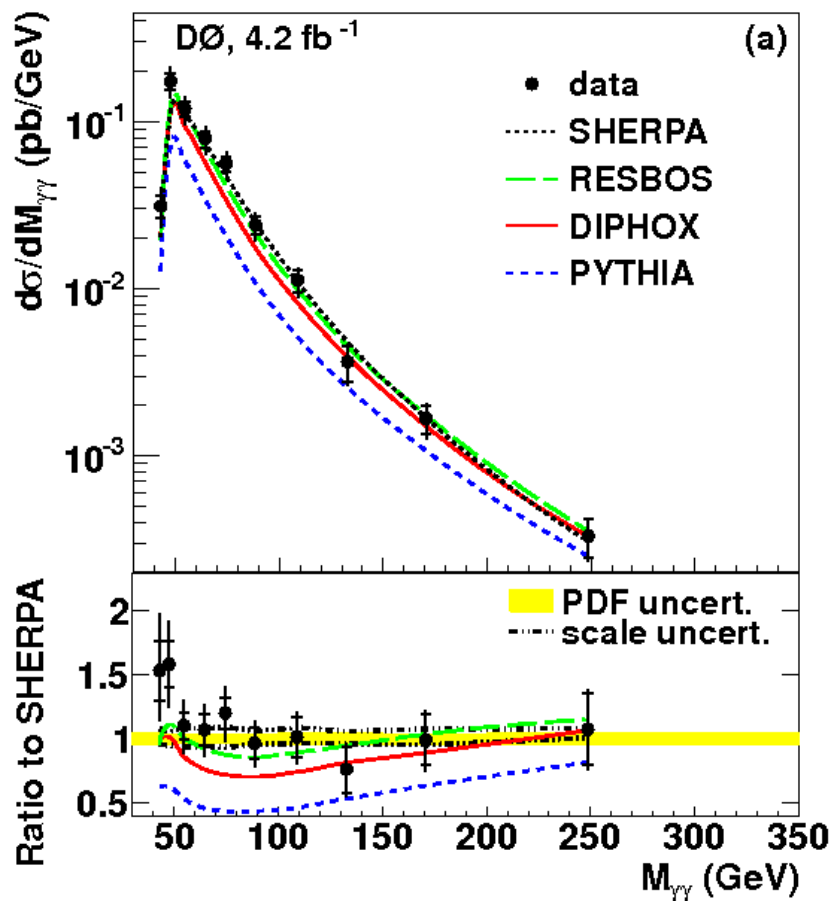

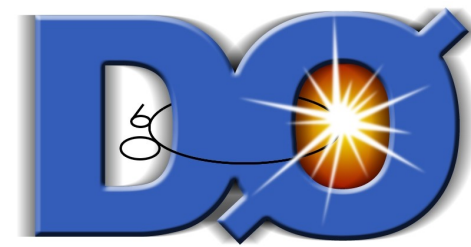

Final discriminant

- Use BDT to build a final discriminant using 5 kinematic variables:
 - Di-photon invariant mass
 - Di-photon transverse momentum
 - Leading/Sub-leading photon transverse energy
 - Azimuthal angle between two photons

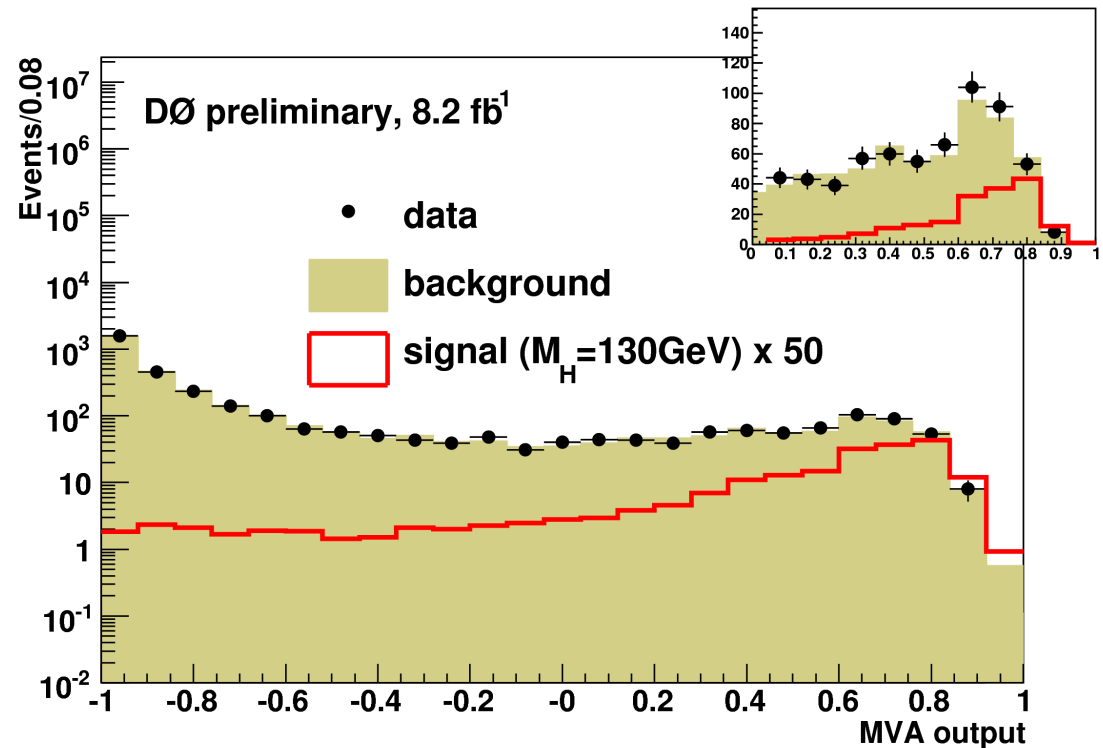



Results

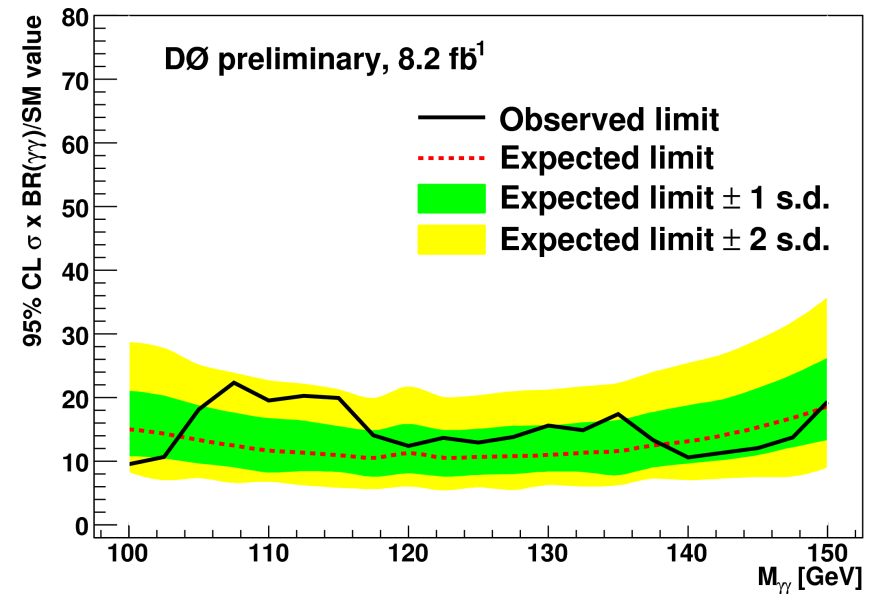
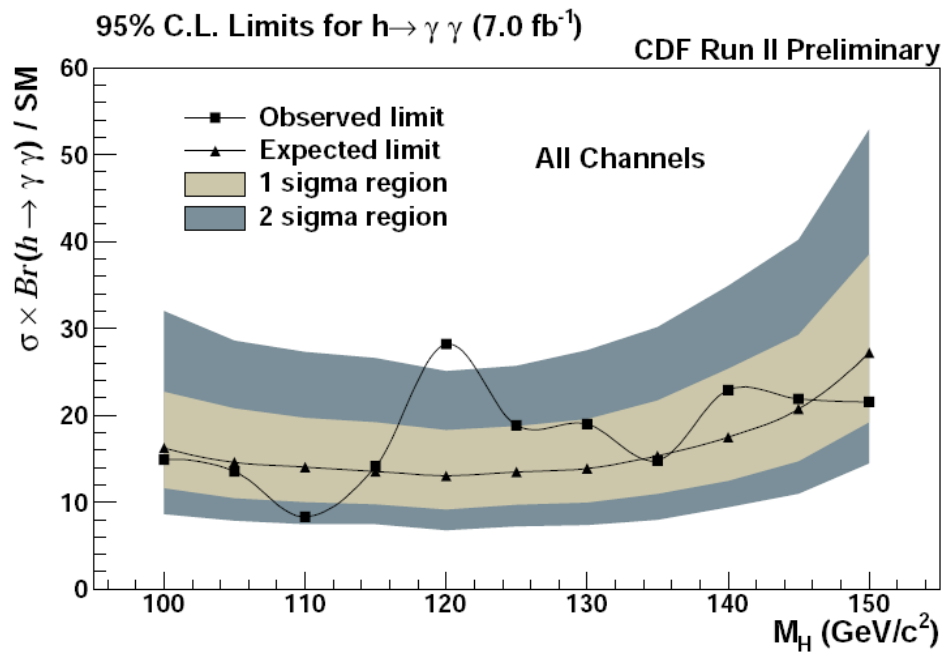
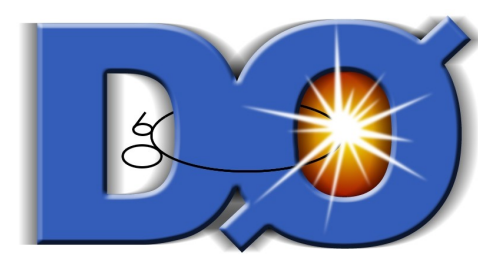

95% C.L. Expected Limits @ 120 GeV
 13xSM for CDF
 11.3xSM for DØ



Combined results

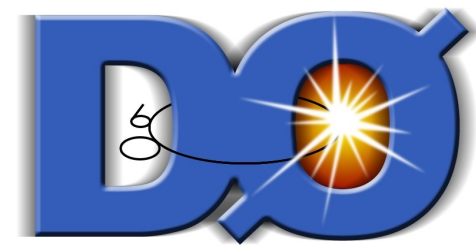

Bayesian	100	105	110	115	120
Expected	10.6	9.2	8.7	8.5	8.3
Observed	7.2	11.7	7.6	10.5	13.4
CL _s	100	105	110	115	120
Expected:	10.5	9.3	8.9	8.5	8.2
Observed:	7.0	11.7	7.6	10.5	13.3
125	130	135	140	145	150
8.2	8.9	9.6	10.8	12.7	16.4
11.3	13.3	11.0	11.1	10.4	13.0
125	130	135	140	145	150
8.2	8.7	9.4	10.7	12.9	16.7
11.3	13.5	11.1	11.2	10.2	12.7



Conclusion

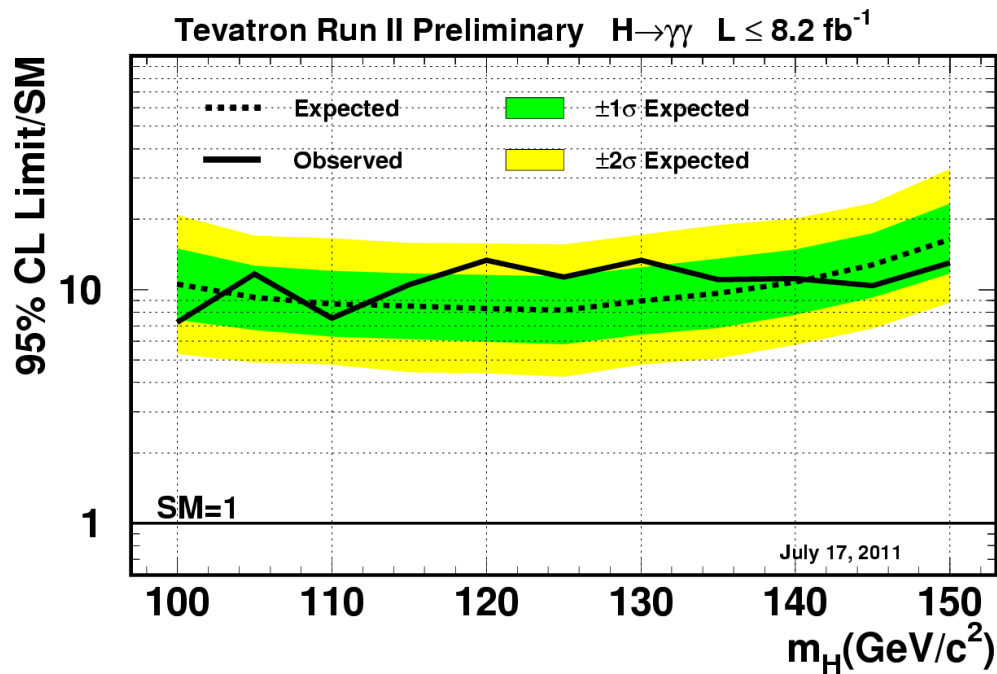
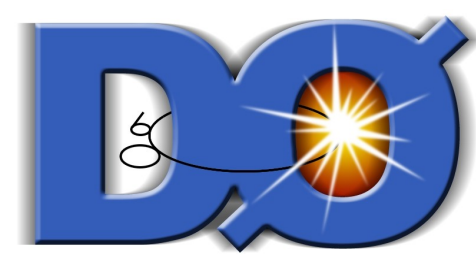

- $H \rightarrow \gamma\gamma$ is a part of the SM Higgs search program at Tevatron, which could contribute to the intermediate mass region.
- Both CDF and DØ have achieved nice results.
- Stay tuned with more data !

back-up

Photon NN for jets at DØ

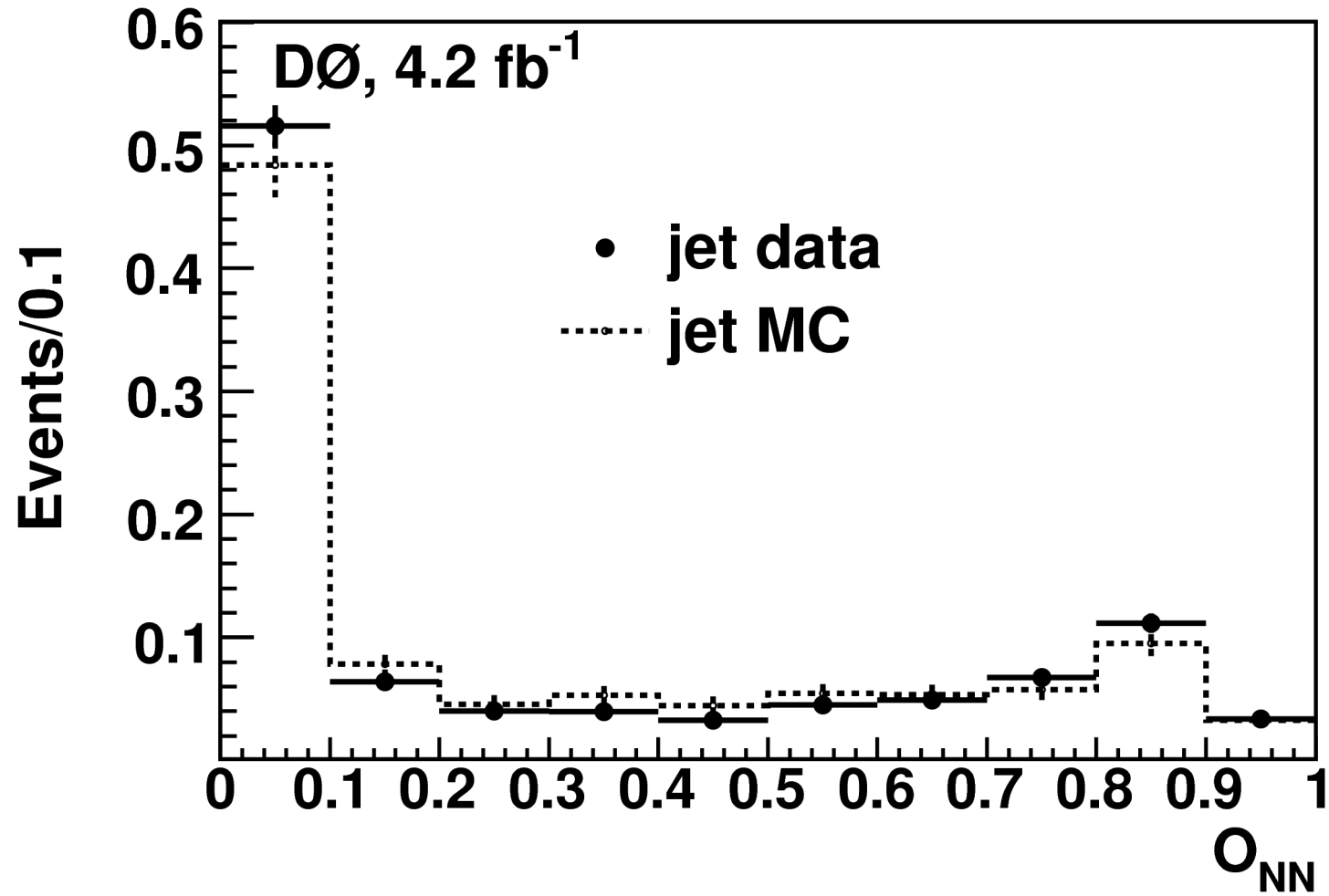

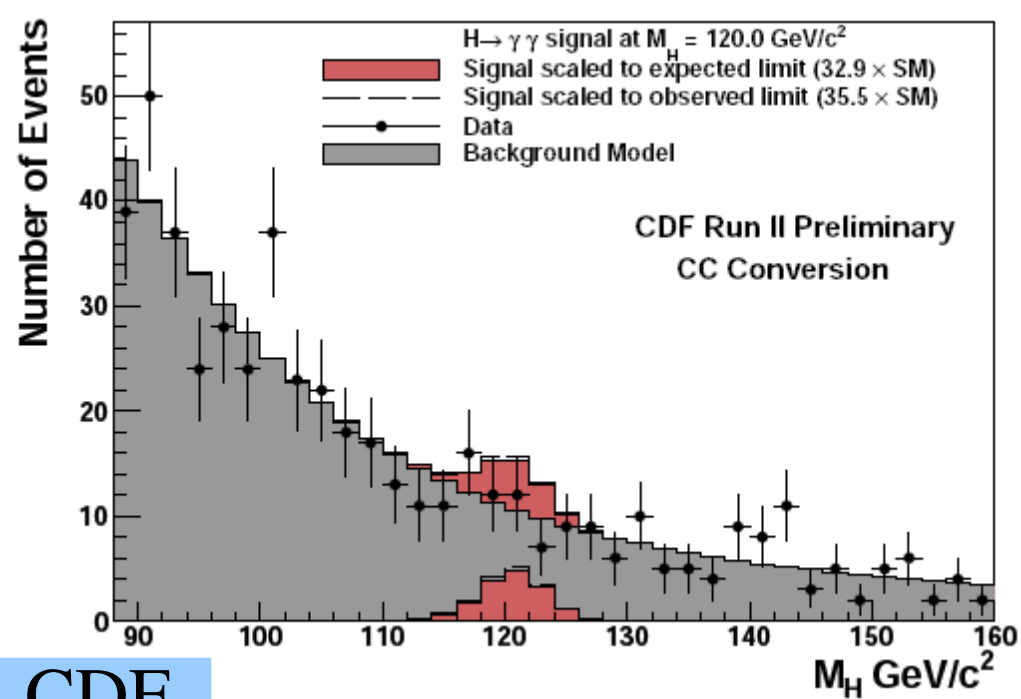
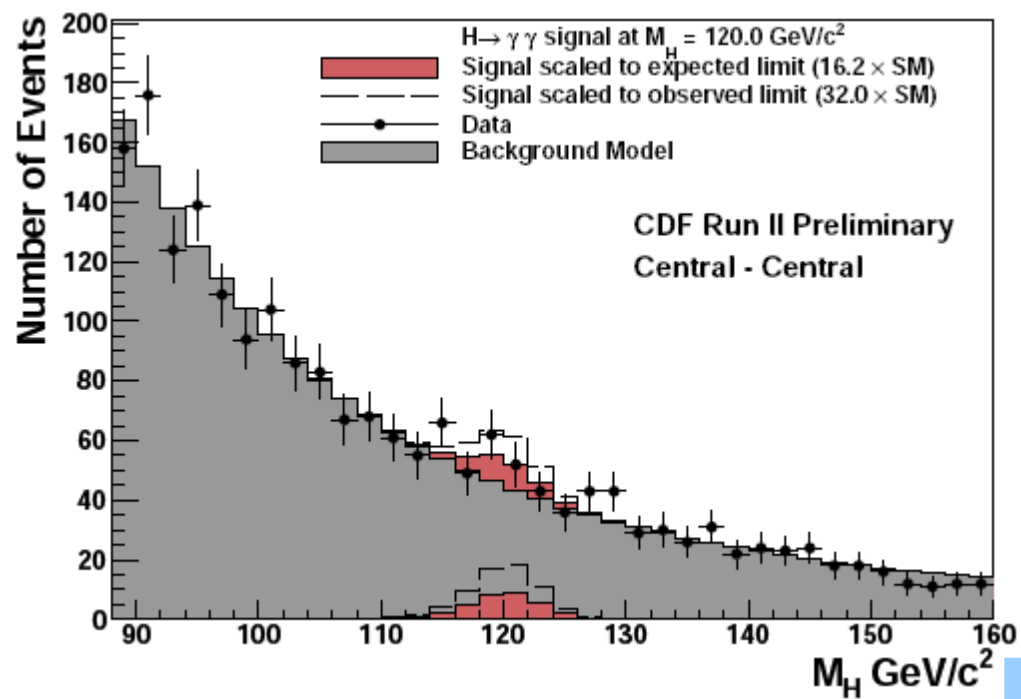

CDF

