

# Office of Science Planning Meeting

Washington DC, May 31<sup>st</sup>, 2011

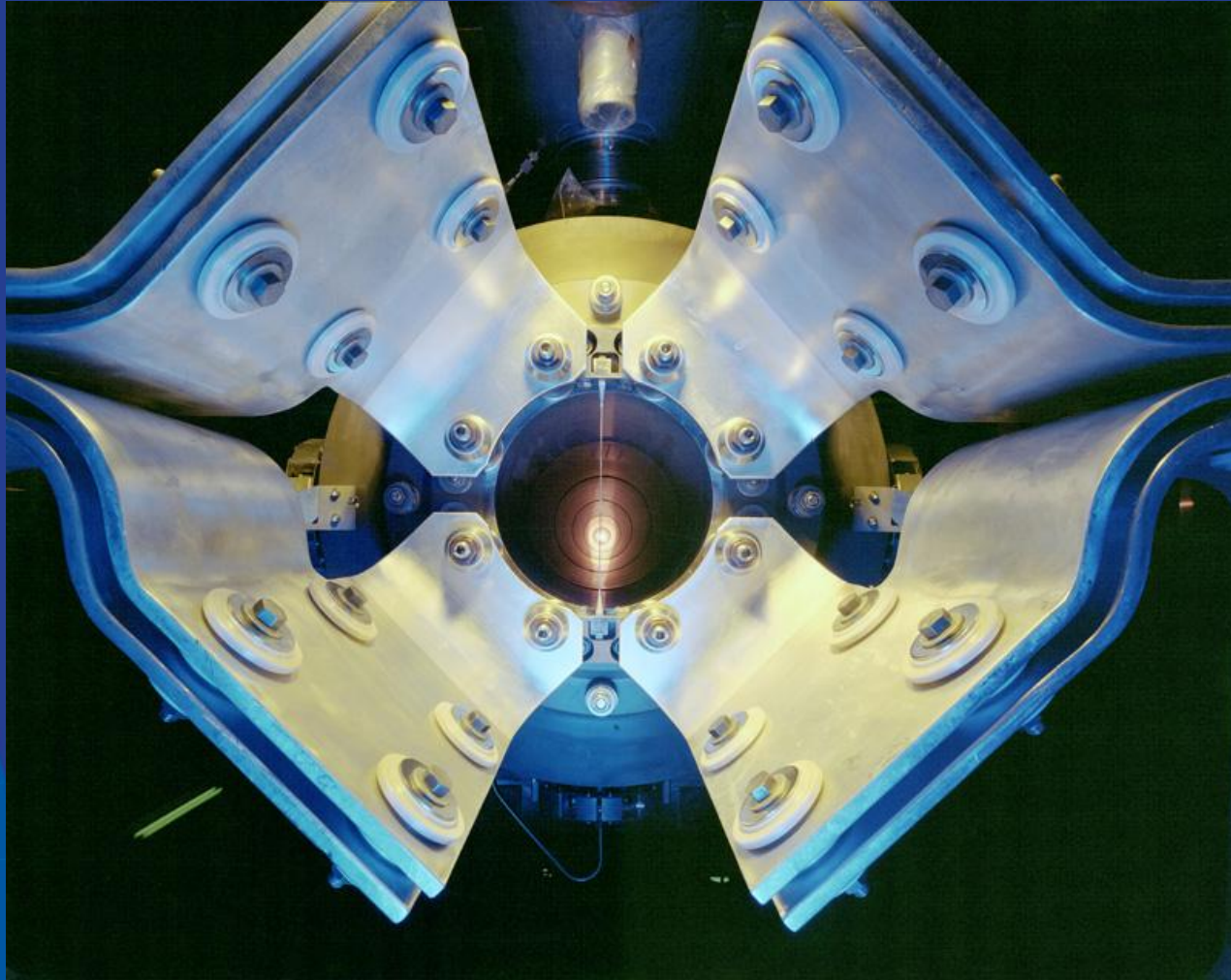

# Fermilab characteristics (FY2010)

- 1925 employees; \$ 385 M (cost)
- 2300 users and visiting scientists
- 6800 acres, park-like site
- Tevatron: the only  $p\text{-}\bar{p}$  collider through FY 2011



- Highest intensity neutrino beams (low and high energy)
- A world class astrophysics, particle theory and computation programs
- Advanced detector and accelerator technology

# Mission: the national particle physics lab

- Enable the US community to tackle the most fundamental physics questions of our era
- Interdependence: integrate the universities and other laboratories fully into national and international programs

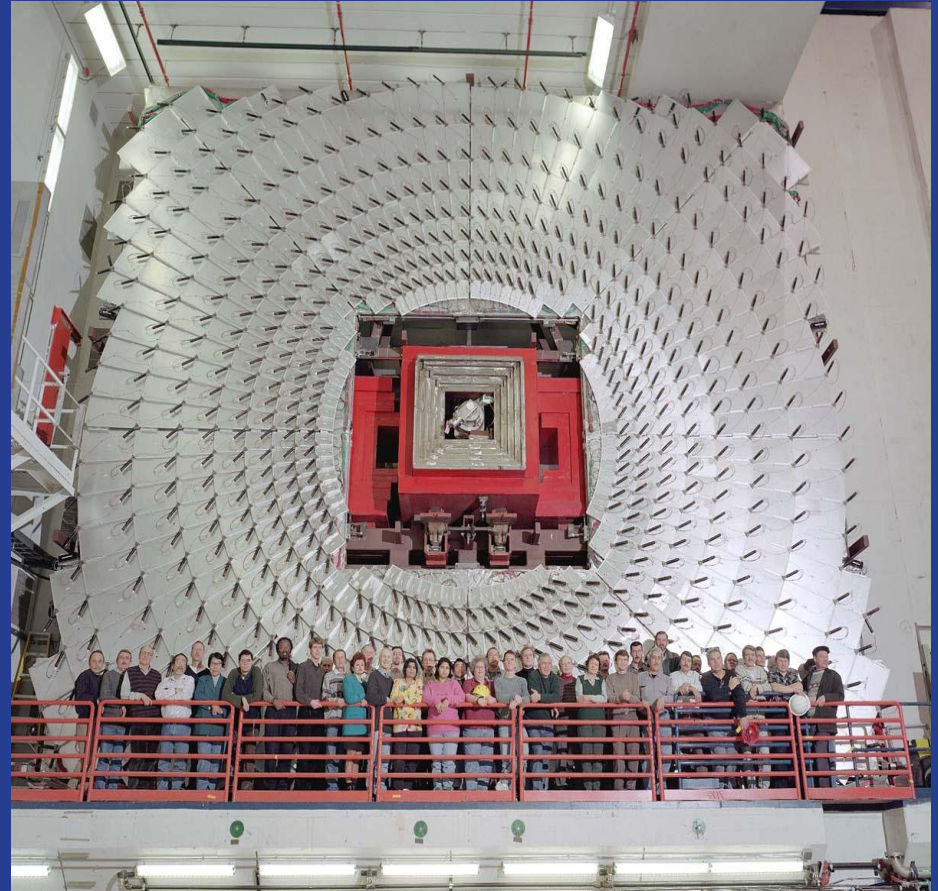

# Collaborative Efforts

- International collaborations for our programs

27 countries



17 countries



24 countries



- Collaboration among DOE laboratories
  - Project X, ILC/SRF, Muon collider, neutrino factory, LHC Accelerator, many particle experiments, ...
- Work for other DOE laboratories
- Argonne-UChicago-Fermilab Collaboration

# Program drivers: science

- The sense of mystery has never been more acute and evident
  - Where does mass come from?
  - Are there extra dimensions of space?
  - Why only three families of quarks and lepton?
  - Why is matter dominant?
  - What are the neutrino masses and what do they say?
  - Where are the heavy neutrino partners?
  - Does nature use supersymmetry?
  - Do the forces unify?
  - What is dark matter?
  - What is dark energy?

# Program drivers: science

- These questions fire the imagination of the public and the press
- As the national laboratory for particle physics, we place the US in a leadership position in the world

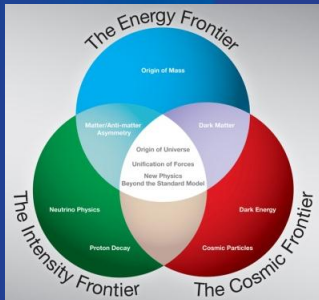

Most elements are in place: exciting opportunities and national strategic plan at each of the three frontiers of particle physics: energy, intensity and cosmic frontiers

- Historically many applications in society through development of accelerator, detector and computational technology

# Overview of presentation

- We will concentrate on the overarching strategy for particle physics, Fermilab's role in it and what we need in order to achieve it
- Particle physics in the US is at a critical juncture: the most important planning issue is to agree on a clear strategy and to obtain the means to support it
- Many of the requested details for this presentation are in the planning document we provided. They are important and underpin Fermilab's ability to implement the proposed strategy

# The strategy

- Should address critical and exciting questions
- Should be bold and establish world leadership in at least one domain
- Should attract partners to leverage our investments through international collaboration
- Should fit within a global strategy for the field and within reasonable US funding
- Should be broad enough to be resilient against physics discoveries and funding fluctuations



# In developing the strategy

- We need to understand the state of knowledge in particle physics
- We need to analyze the international situation to insure we add maximum value to the global program
- We need to make realistic budgetary assumptions
- We need to think very long term (2-3 decades)

# The state of knowledge

- The present theory is a remarkable intellectual construction
- Every particle experiment ever done fits in the framework
- But it is not complete; basic symmetries of the Lagrangian require symmetry breaking

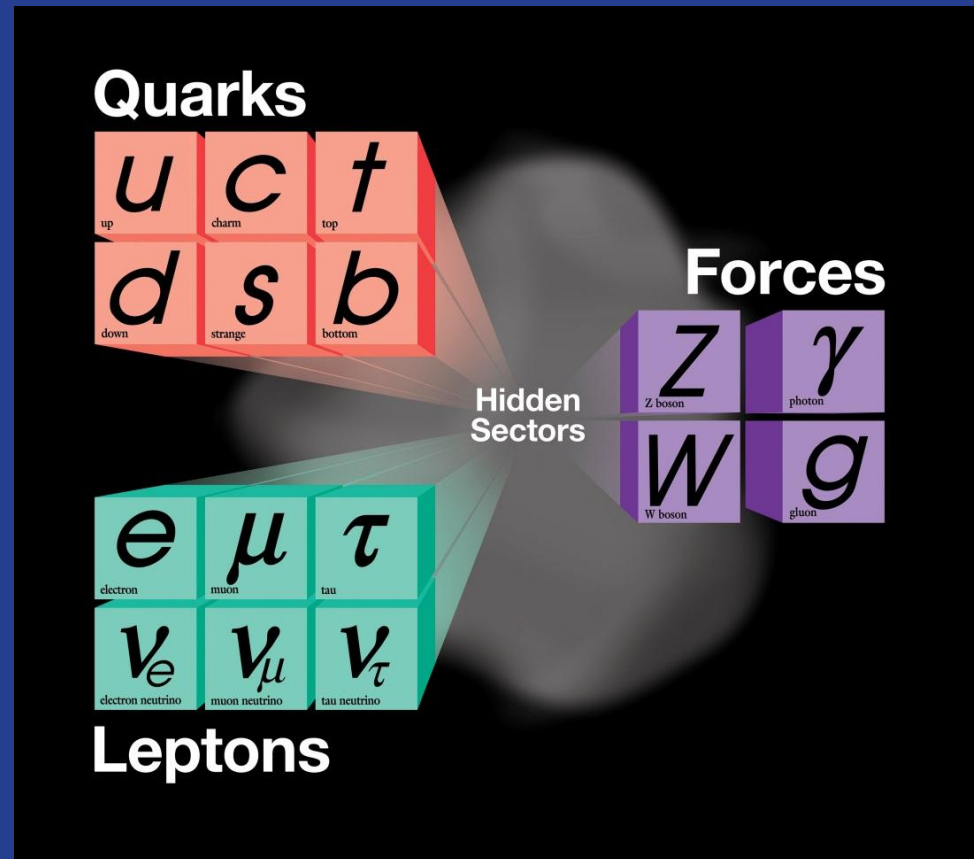

# Hunting grounds: energy frontier

- Direct production of new phenomena: LHC for the next two decades and future high energy colliders
- Energy reach typically limited to 1/10 of total energy for hadron colliders
- Very large QCD backgrounds limit many measurements

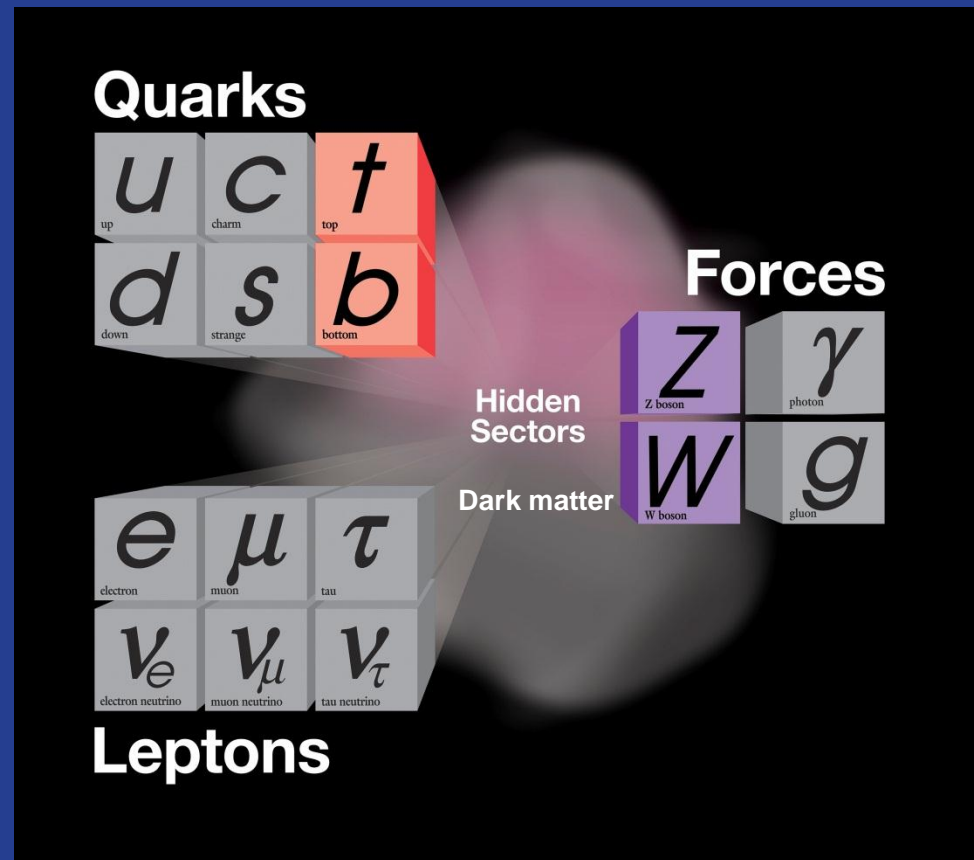

The top and bottom quarks were discovered at Fermilab

# Tevatron: a legendary machine



## Accelerator Innovations

- First major SC synchrotron
- Industrial production of SC cable (MRI)
- Electron cooling
- New RF manipulation techniques



## Detector innovations

- Silicon vertex detectors in hadron environment
- LAr-U238 hadron calorimetry
- Advanced triggering



## Analysis Innovations

- Data mining from Petabytes of data
- Use of neural networks, boosted decision trees
- Major impact on LHC planning and developing
- GRID pioneers

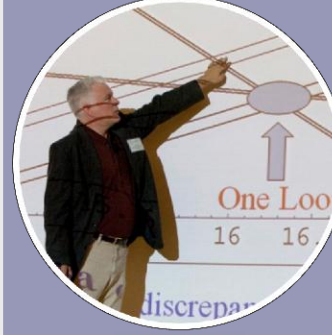

## Major discoveries

- Top quark
- $B_s$  mixing
- Precision  $W$  and Top mass  $\rightarrow$  Higgs mass prediction
- Direct Higgs searches
- Ruled out many exotica



## The next generation

- Fantastic training ground for next generation
- More than 500 Ph.D.s
- Produced critical personnel for the next steps, especially LHC

# Status of the LHC

- The accelerator is performing extraordinarily well – lots of headroom
- 4 detector collaborations are able to analyze data rapidly – CMS+ATLAS already excluding significant areas of supersymmetry,  $Z'$  .....

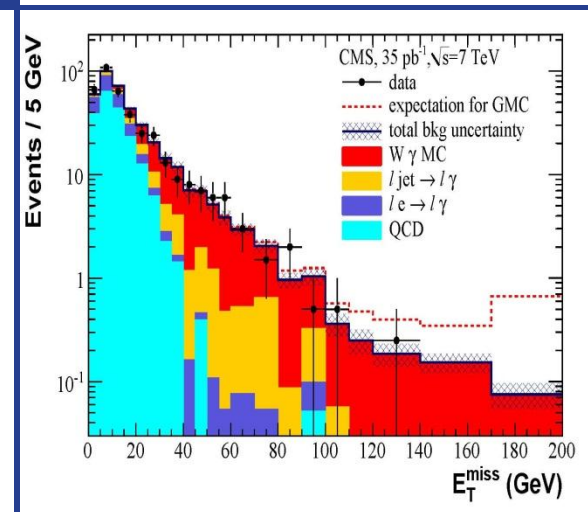
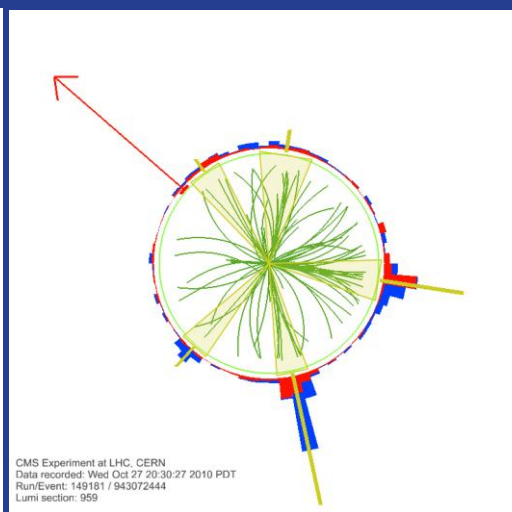
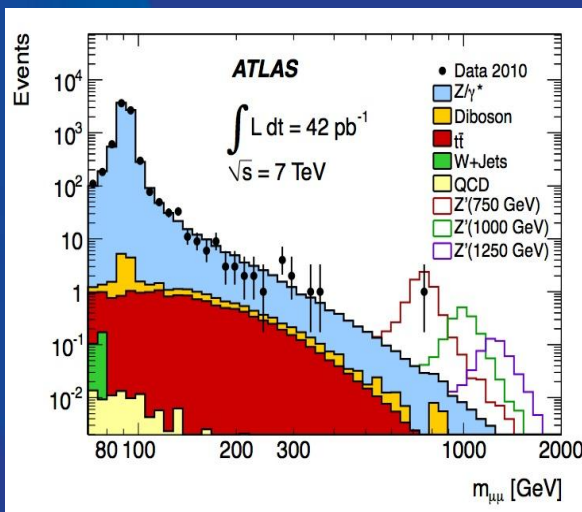
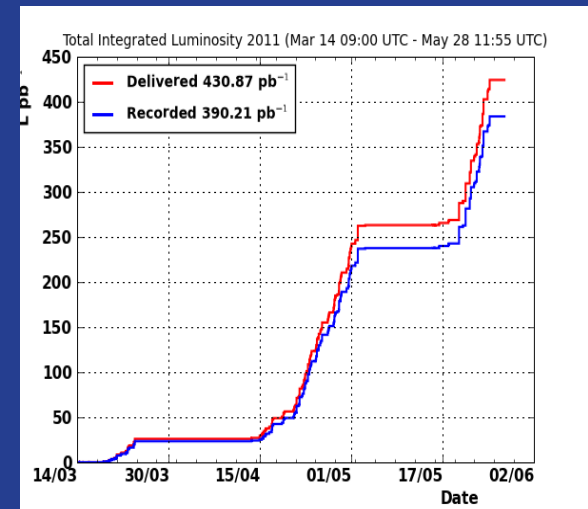

# Range of outcomes from LHC

- At one extreme, extraordinarily rich (great expectations):



- At the other extreme: shows something only at the highest energy and integrated luminosity (no-lose theorem)



# The hunting grounds: quarks

- Intensity frontier: rare transformations that happen only with the help from the hidden sectors
- Charm quark and bottom quark explored in  $e^+e^-$  colliders (“quark factories”) planned at the state of the art
- Strange quark studied with hadron beams: now far from the “state of the art”

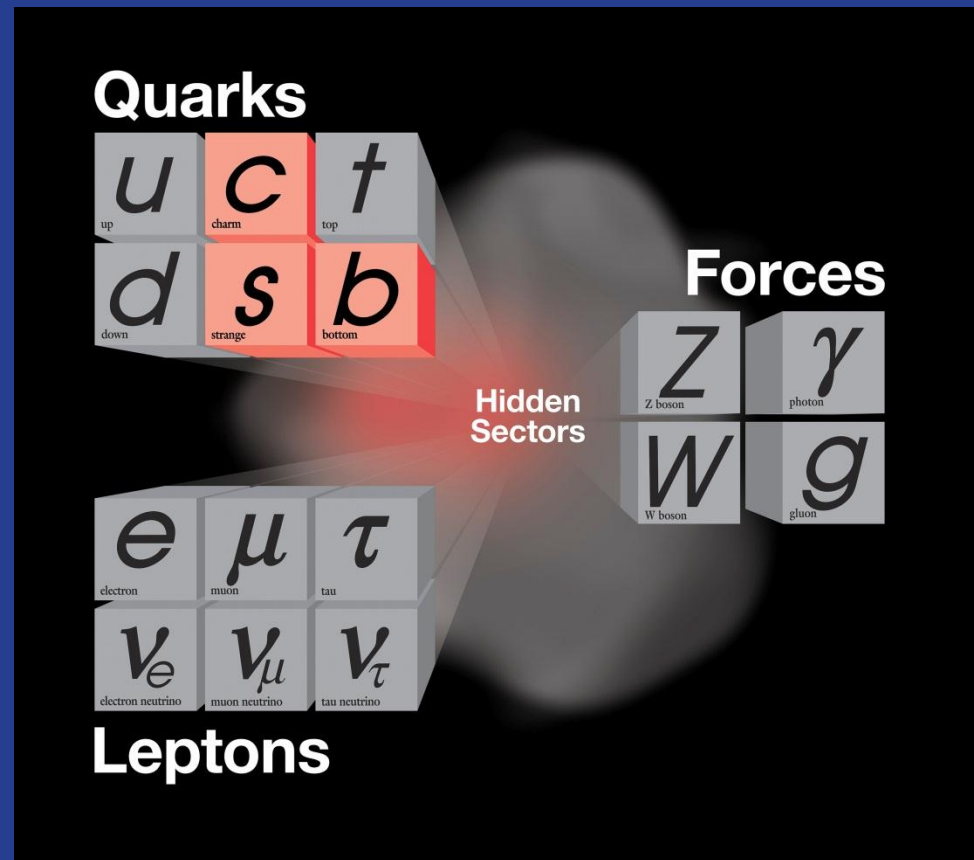

# The hunting grounds: leptons

- Intensity frontier: the tau lepton studied at  $e^+e^-$  b-factories and c-factories at the state of the art
- All other charged leptons and neutrinos studied with superbeams presently far from the state of the art:
  - Electron dipole moment
  - Rare muon decays, muon anomalous magnetic moment
  - Neutrino mixing matrix, sterile neutrinos, CP violation

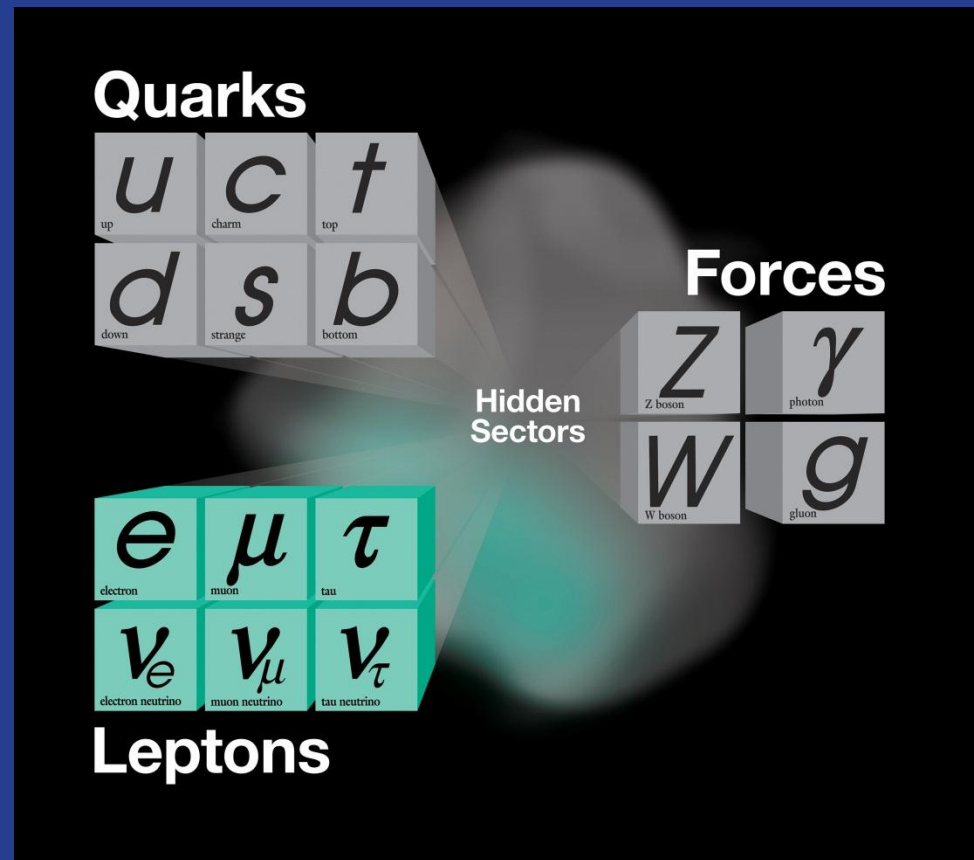

The tau neutrino was discovered at Fermilab



# The hunting grounds: cosmic frontier

- Nature of neutrinos: neutrinoless double beta decay, far from the possible state of the art
- Dark energy: constant or changing? Far from the possible state of the art
- Dark matter: direct detection far from the possible state of the art
- Proton decay

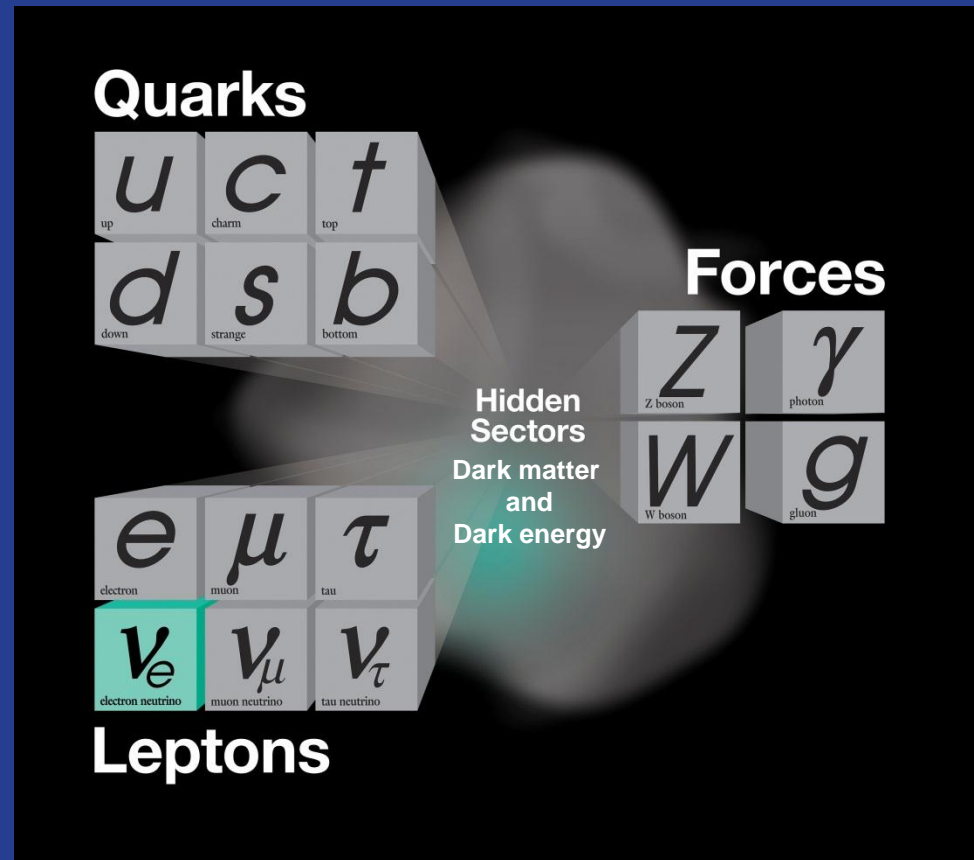

# The international context

- **Europe**
  - Will be dominant at the energy frontier for the next two decades as the Tevatron was for the last two and a half decades
  - Italy has launched an effort to build the next generation B-factory with 50 times the luminosity of previous B factories. It will be a “European” facility
  - Has a world class underground laboratory at Grand-Sasso (not adequate for large long base-line neutrino experiments).

# The international context

- **Europe**
  - The LHC has come into its own. Luminosity is greater than  $10^{33} \text{ cm}^{-2}\text{sec}^{-1}$ . More importantly it has a lot of head-room: higher beam-beam limit, larger aperture, lower emittance, higher intensity per bunch → several times planned luminosity is possible.
  - CERN will be occupied with LHC and LHC upgrades and with developing  $e^+e^-$  linear colliders (ILC or CLIC). CERN is unlikely to build next generation intensity frontier experiments (neutrinos and rare decays) unless the LHC results point to an energy scale that is beyond practical machines to reach directly.

# The international context

- **Europe**
  - The rich get richer: direct investment in CERN is \$1.2B, 50% higher than total US program and three times investment in the Fermilab program. However, the effective investment in the program is even larger than that because the whole world is contributing.
  - CERN is aggressively pursuing a strategy to become the world's HEP lab: a) membership now open to all countries, b) associate membership established at 10% normal contribution and c) but CERN is now allowed to invest in international global programs if Europe is involved. Next European Strategy in 2012.

# The international context

- **Europe**
  - At the cosmic frontier Europe does not have a competitive program in dark energy comparable to the ground-based DES and LSST. It will be competitive with the EUCLID satellite.
  - It has a fully competitive, current generation direct dark matter searches (e.g. XENON) and in neutrinoless double beta decay experiments (e.g. CUORE) with plans for upgrades in the future. These are all international projects but hosted in Europe
  - In the short term it has a competitive reactor neutrino experiment (DOUBLE CHOOZ)

# The international context

- **Asia**
  - Japan is building a next-generation  $e^+e^-$  B-factory with 50 times previous luminosities at KEK
  - Japan has a world competitive neutrino program with J-PARC (present performance one half to one third of Fermilab's; expected to match Fermilab in the NOvA era at 700 kWatts) and SuperK with 20 kton fiducial at Kamioka. There are long range plans to build larger detectors at longer base-lines.
  - China has the best reactor neutrino experiment (DAYA BAY) and Korea an earlier but ultimately less competitive experiment (RENO)

# The international context

- **Asia**
  - China is developing a very deep underground laboratory (JINPING). It was an idea two years ago, now there are caverns. Beautiful, deep, horizontal access site – but no Fermilab to send neutrinos
  - Dark energy experiment at the 8m SUBURU telescope in Hawaii. SUBURU is probably the best 8m telescope in the world. Dark matter survey is limited by availability of time on the telescope.

# The international context: a map

- A lot of territory is covered **internationally** at the state of the art
- The greatest impact and **leadership for the US** is in neutrinos and rare processes, where major improvements are possible

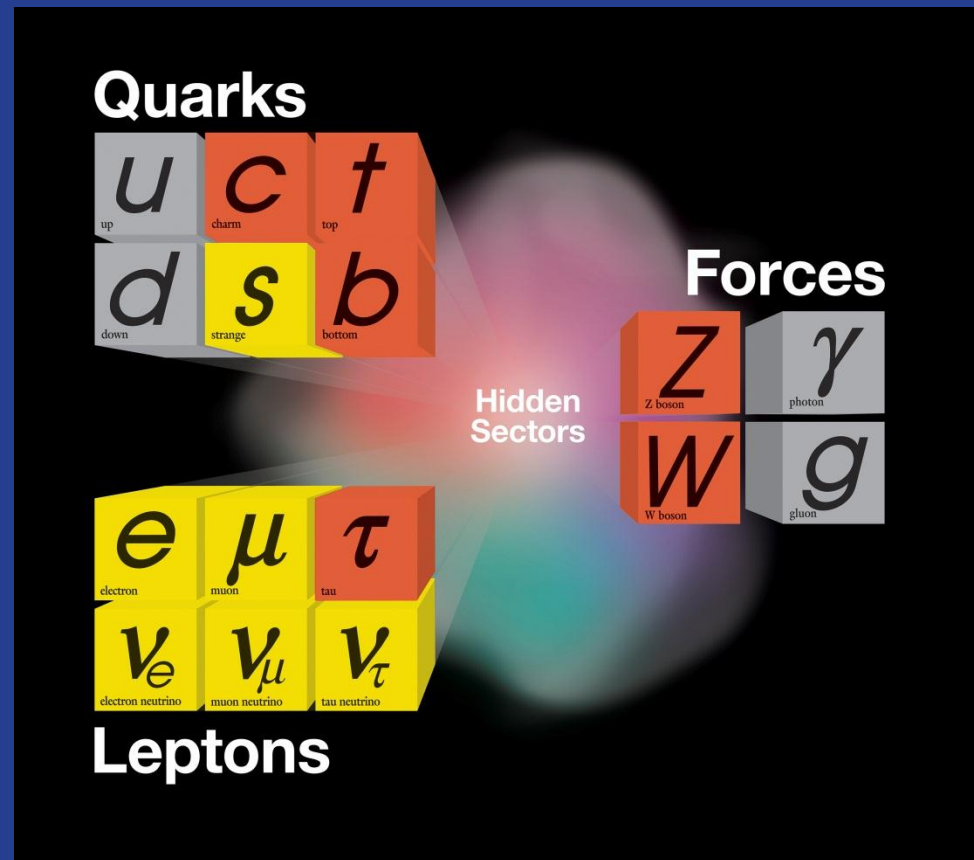



# US leadership domains

- **Accelerator based program:** at the intensity frontier with a series of experiments (long and short baseline neutrino programs, rare kaon and muon decays,  $g-2$ ,  $\text{Mu}2e$ , EDM) . LBNE and *Project X* are the major attractors for international collaboration in the long term program as are energy applications of high intensity proton accelerators
- The accelerator based program in the US is quite competent in the next decade even without *Project X*, with a series of world class experiments. Beyond this decade we need LBNE and *Project X* to assure leadership of this domain by a large margin. A multipolar world is important to maintain open use of facilities

# US leadership domains

- **The cosmic frontier:** leadership in ground-based dark energy with DES, LSST; unlikely for space based probes. Competitive programs in dark matter and dark energy experiments where we could try to establish the leadership position; similarly we could stake out the leadership position in neutrino-less double beta decay.
- The leadership in the cosmic frontier is shared both nationally and internationally. All major ground telescopes are private or operated by NSF. The major future ground based telescopes LSST is primarily an NSF project with important DOE contributions. Space probes are controlled by NASA. Dark matter experiments are international and operate in deep underground laboratories abroad

# What is the proposed program?

- **In the intermediate term**, a series of world-class experiments (built upon our current world-class program), exploiting the present complex with modest upgrades (go to afterburners). Produce continuous stream of results
  - **NOvA**:  $\nu$  vs.  $\bar{\nu}$ , next step in oscillation parameters
  - **MicroBooNE**: follow **MiniBooNE** anomaly; LAr TPC
  - **MINERvA**:  $\nu$  nuclear cross sections/nuclear structure
  - **MINOS+ (proposed)**:  $\nu$  vs.  $\bar{\nu}$ ; anomalous interactions
  - **LBNE (700 kW)**: neutrino oscillations, proton decay, SN
  
  - **g-2**: anomalous magnetic moment of the muon
  - **Mu2e**: direct muon to electron conversion
  - **SeaQuest**: nuclear physics Drell-Yan process

# An aside.....

- **Why multiple neutrino experiments?** Many aspects are still unclear in the neutrino sector (neutrinos vs. antineutrinos; mixing matrix; existence of sterile neutrinos; anomalous interactions.....). Their study requires different baselines, different energies, different detector technologies
- Unlike charged beams, neutrino beams are not exhausted by placing one experiment in the beam: we can “stack” multiple experiments in one neutrino beam both in line and in angle

# Near and intermediate stages

## This decade

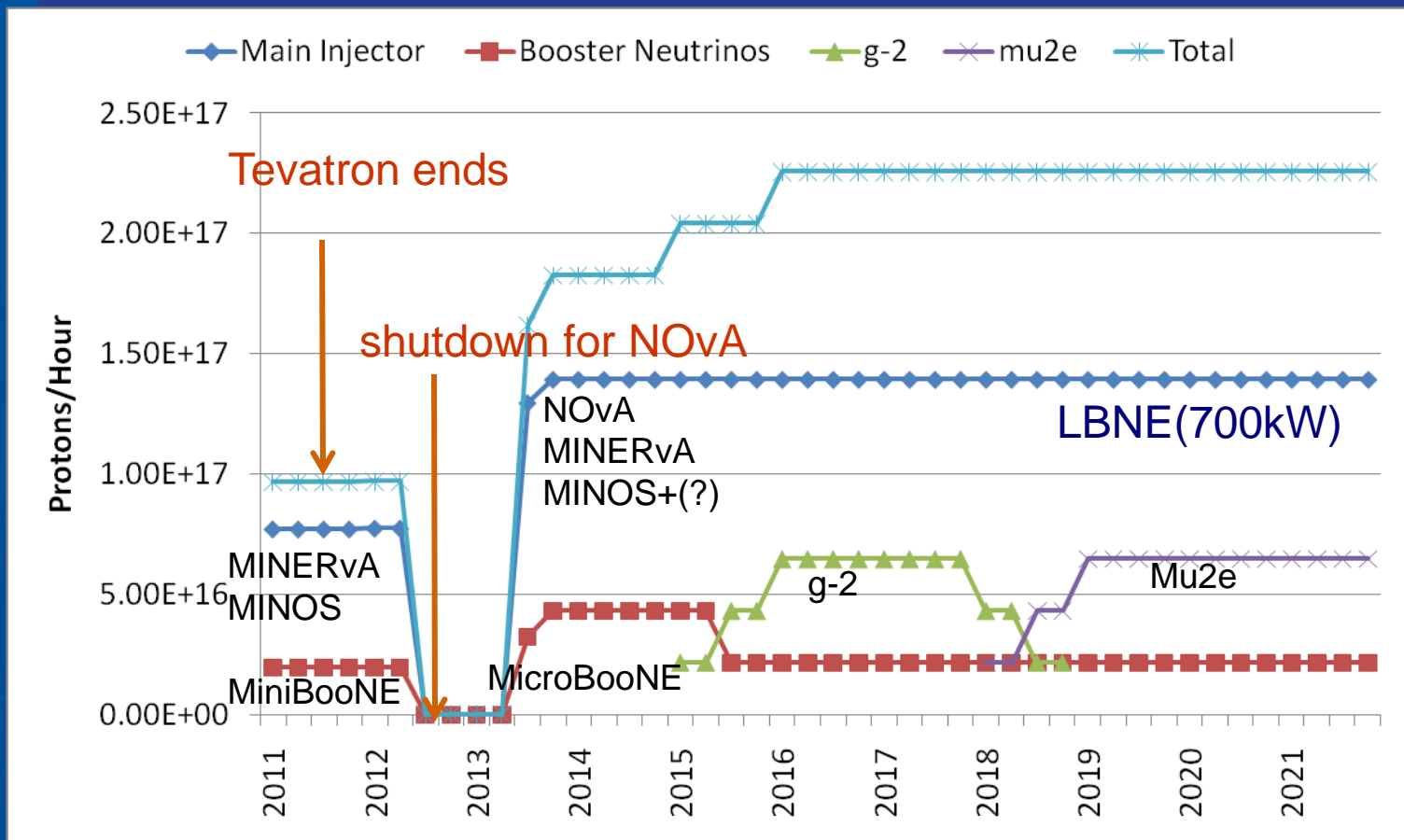

Next Decade *Project X*: 100 times

# Intensity Frontier Today at Fermilab

Take Home Message: we have a set of world-class experiments over the next decade BEFORE Project starts operating

EXPERIMENT	INSTITUTIONS	NATIONAL LABORATORIES	COLLABORATORS	FOREIGN COUNTRIES
MINOS	29	3	148	U.K, Brazil, Poland, Greece
MiniBooNE	18	2	84	
MINERvA	27	2	127	Peru, Greece, Brazil, Chile, Mexico, Russia
SeaQuest (NP)	18	4	65	Japan, China
NOVA	28	2	180	Greece U.K, Russia, Germany, Brazil
MicroBooNE	13	3	70	
g-2	20	2	67	Russia, U.K, Italy, Germany, Japan
Mu2e	22	3	105	Italy, Russia
LBNE	58	6	306	U.K, Japan, Italy, India

# MINOS Results on $\Delta m^2_{23}$ and $\theta_{23}$



- Neutrino runs
  - best  $\Delta m^2_{23}$
  
- Anti-neutrino runs
  - Tension between  $\nu$ 's and anti- $\nu$ 's

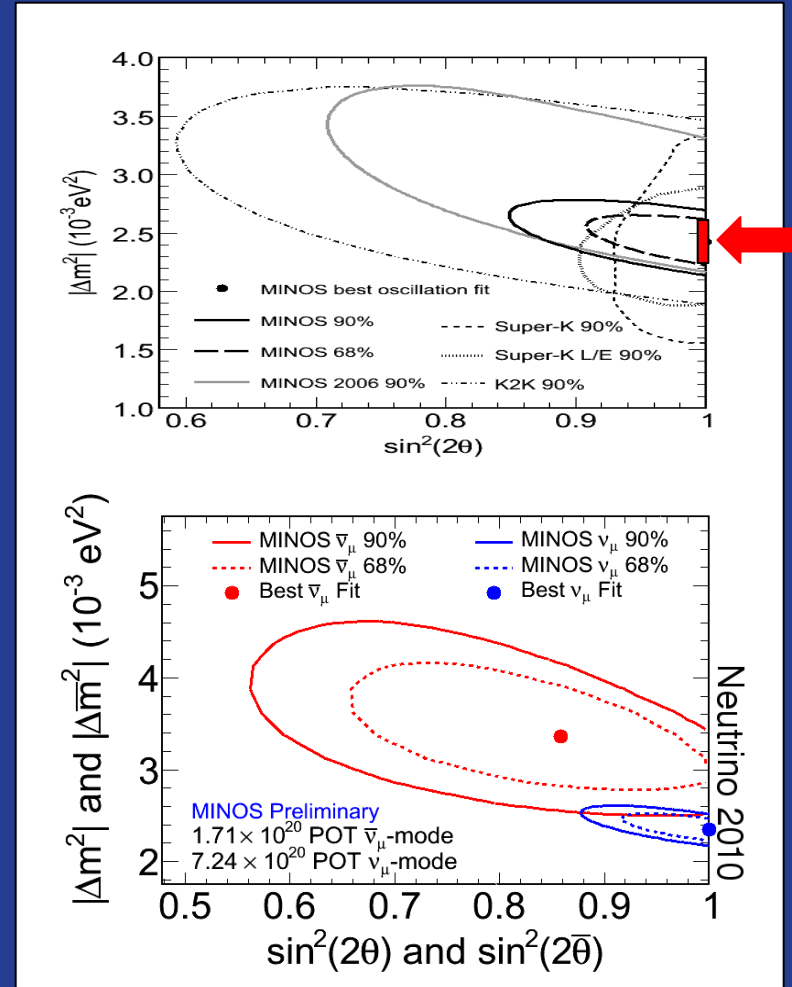

# MINOS Results on $\theta_{13}$

- Electron appearance measurement
- Comparable and consistent with the CHOOZ limit

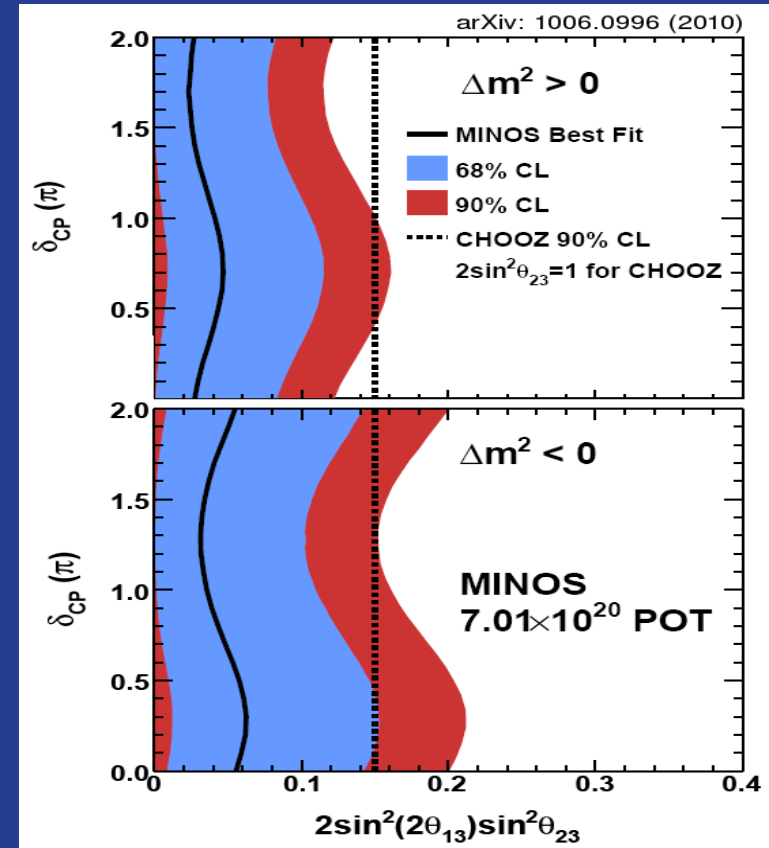



# MINOS Run extension (FY13-14) – TBD

Sensitivities to new physics

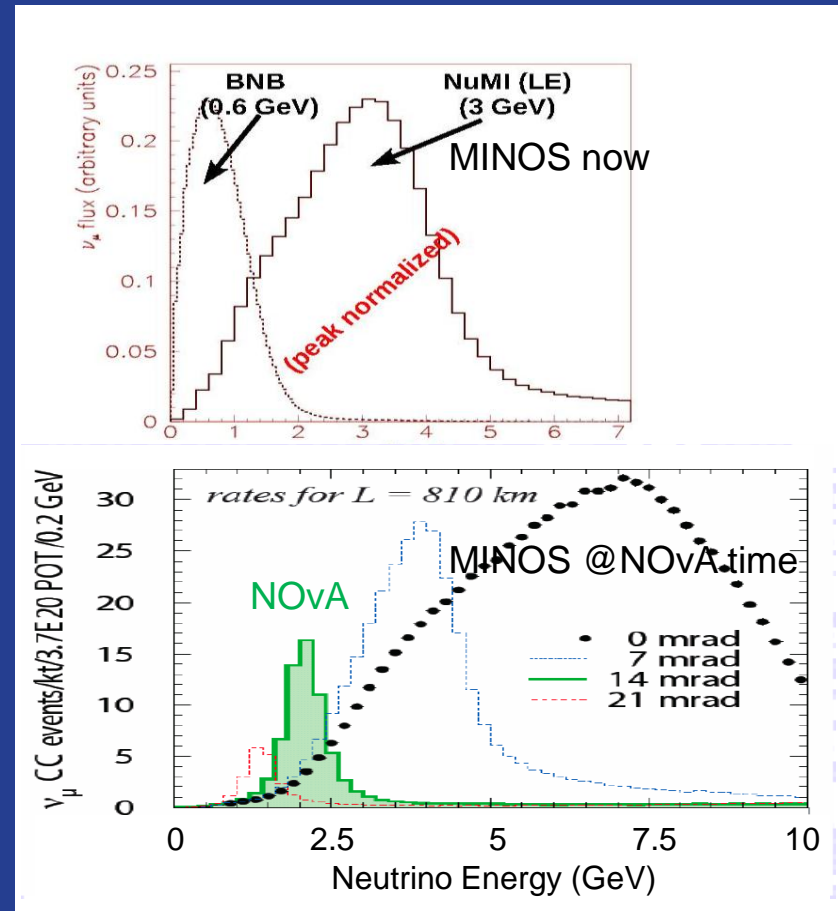
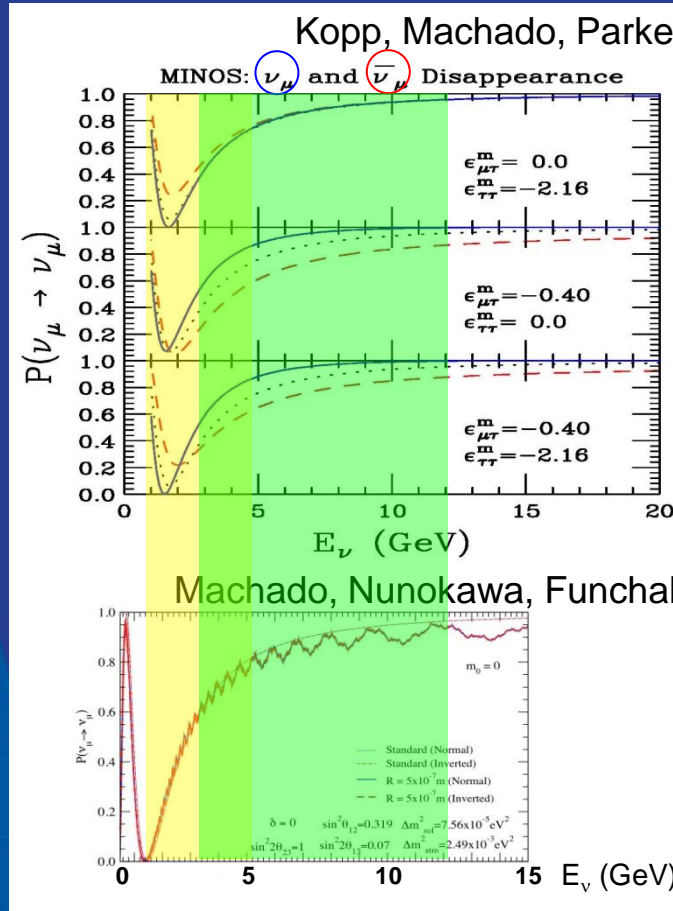

Will be discussed at the June 2011 PAC meeting

# MiniBooNE

- Anomaly in low momentum neutrinos
- Neutrinos and antineutrinos may be different: neutrinos exclude LSND, antineutrinos consistent with LSND
- Sterile neutrinos?



# MINERvA program of cross sections

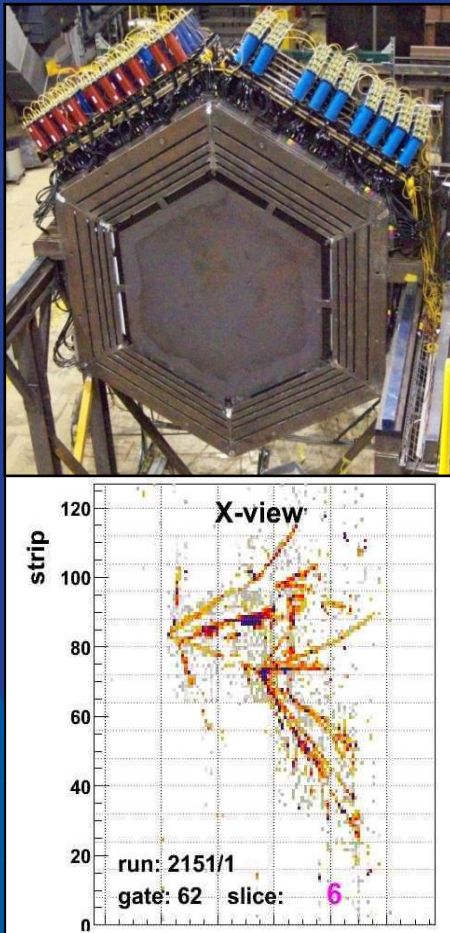

$\bar{\nu}_\mu$  Quasi-Elastic Kinematics ( $\bar{\nu}_\mu + p \rightarrow \mu^+ + n$ )

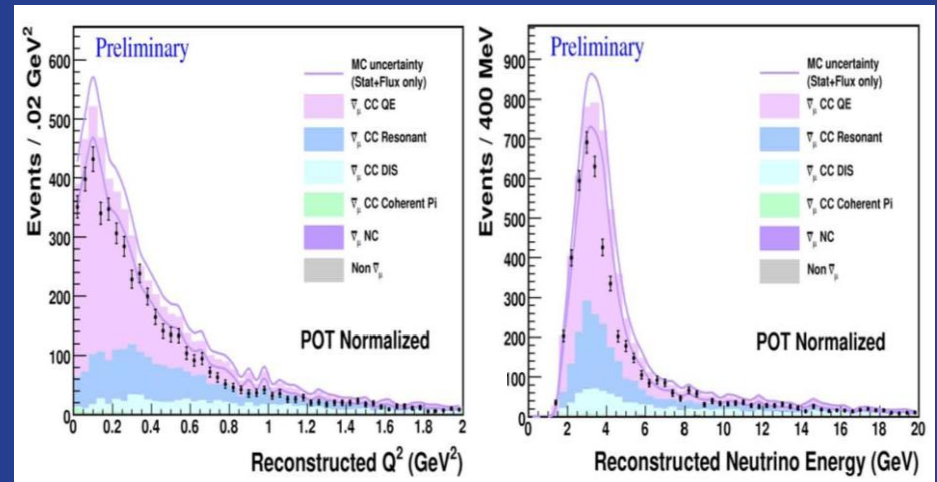

# MicroBooNE

- Follow excess in MicroBooNE anomaly. Critical to determine it is electrons or photons?
- Use Liquid Argon TPC: physics + further development of the technology

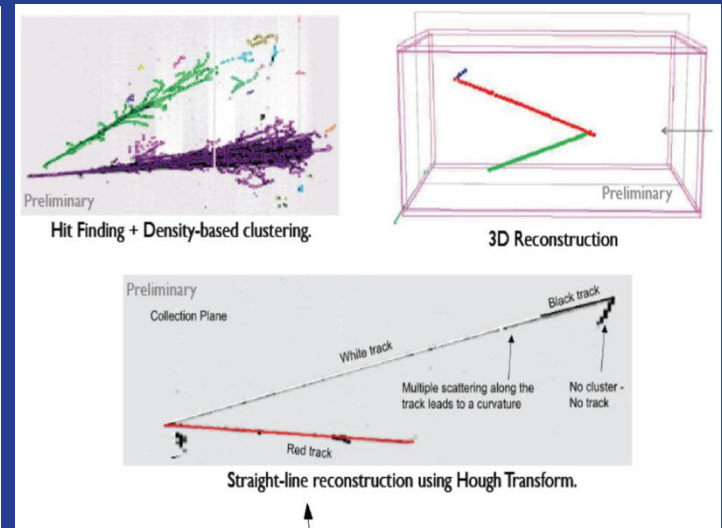
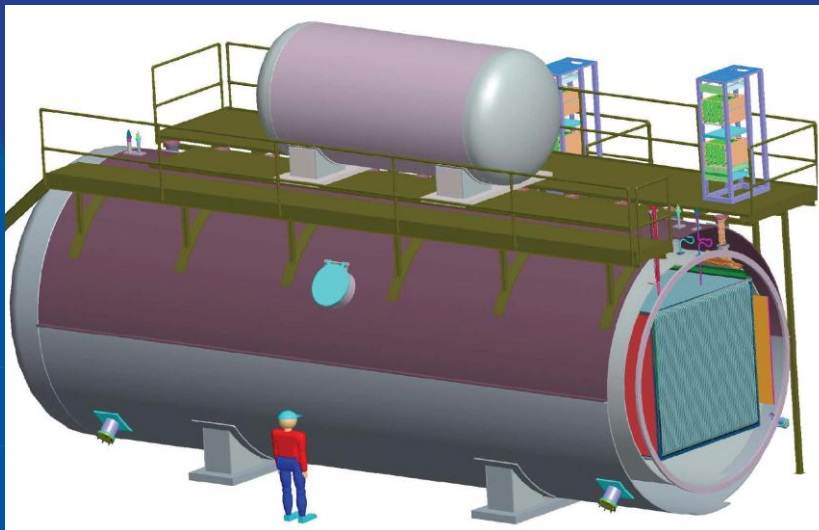

# NOvA

- Electron appearance and next step in oscillation parameters. Neutrinos vs. antineutrinos: different parameters?

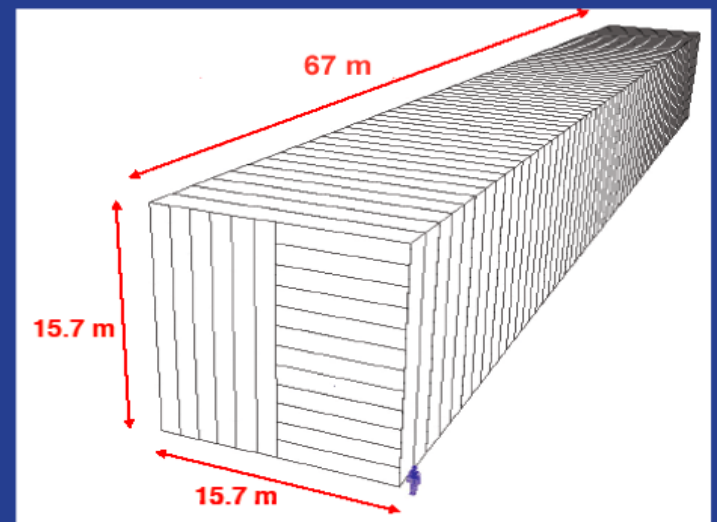

# A new (g-2) to uncertainty $0.14 \cdot 10^{-11}$

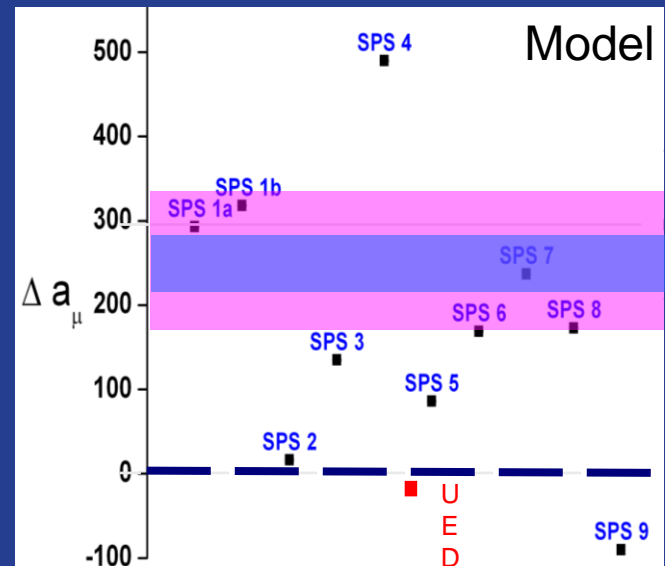
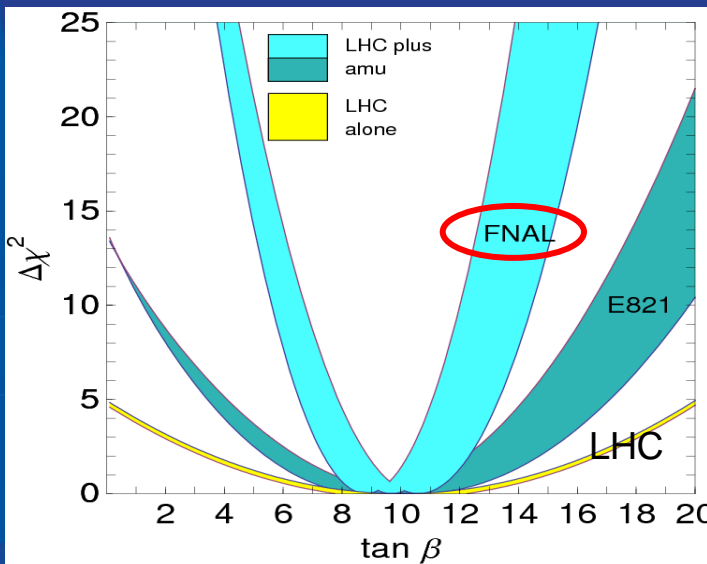
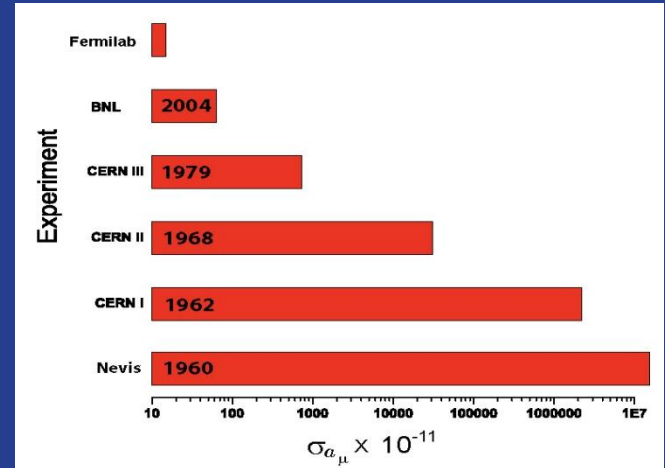

# Mu2e experiment can probe $10^3$ – $10^4$ TeV

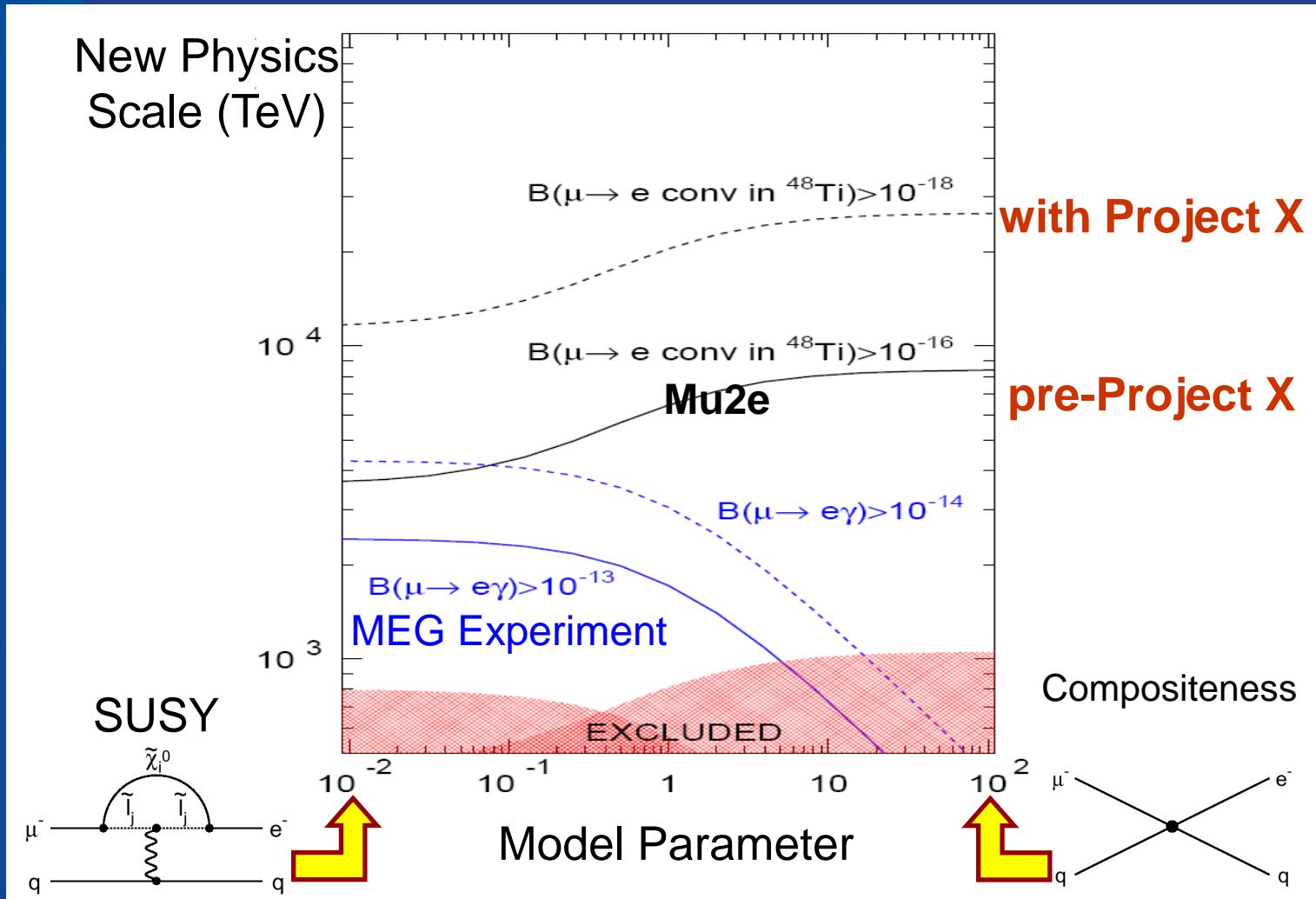

# Implementing the vision: LBNE

- LBNE is a key experiment in the neutrino area and already engages a very broad collaboration
- It can start with the 700kW beam developed for NOvA (facilities have to be built towards the DUSEL direction)
- It would ultimately use over >2000kW in the *Project X* era



# Long Baseline Neutrino Experiment

CD 0: January 2010

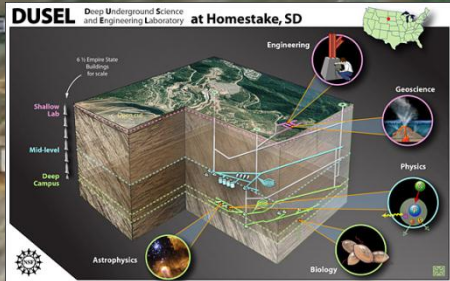

Collaboration: 306 members  
58 institutions (6 US labs) and 5 countries (India, Italy, Japan, UK, US)  
Continue to grow!

# Conceptual Design Overview – Neutrino Beam

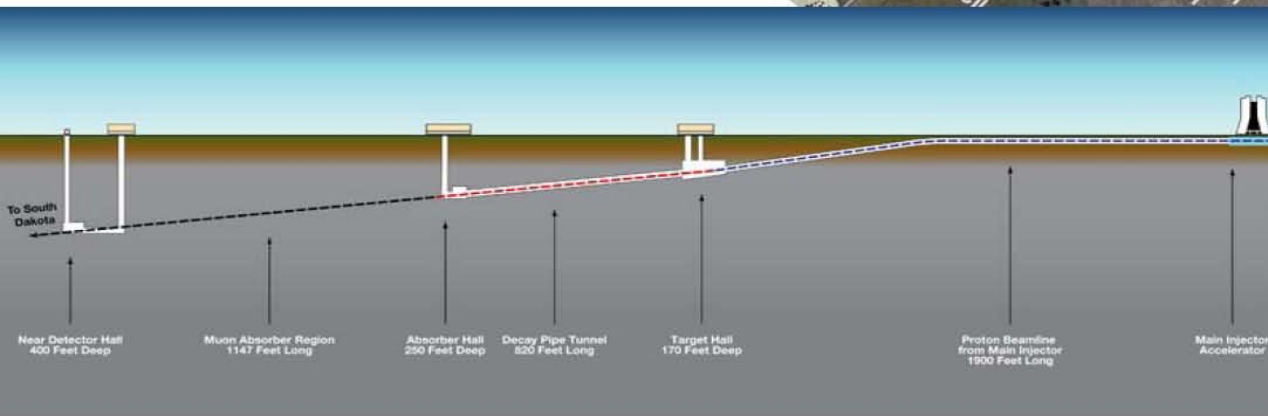
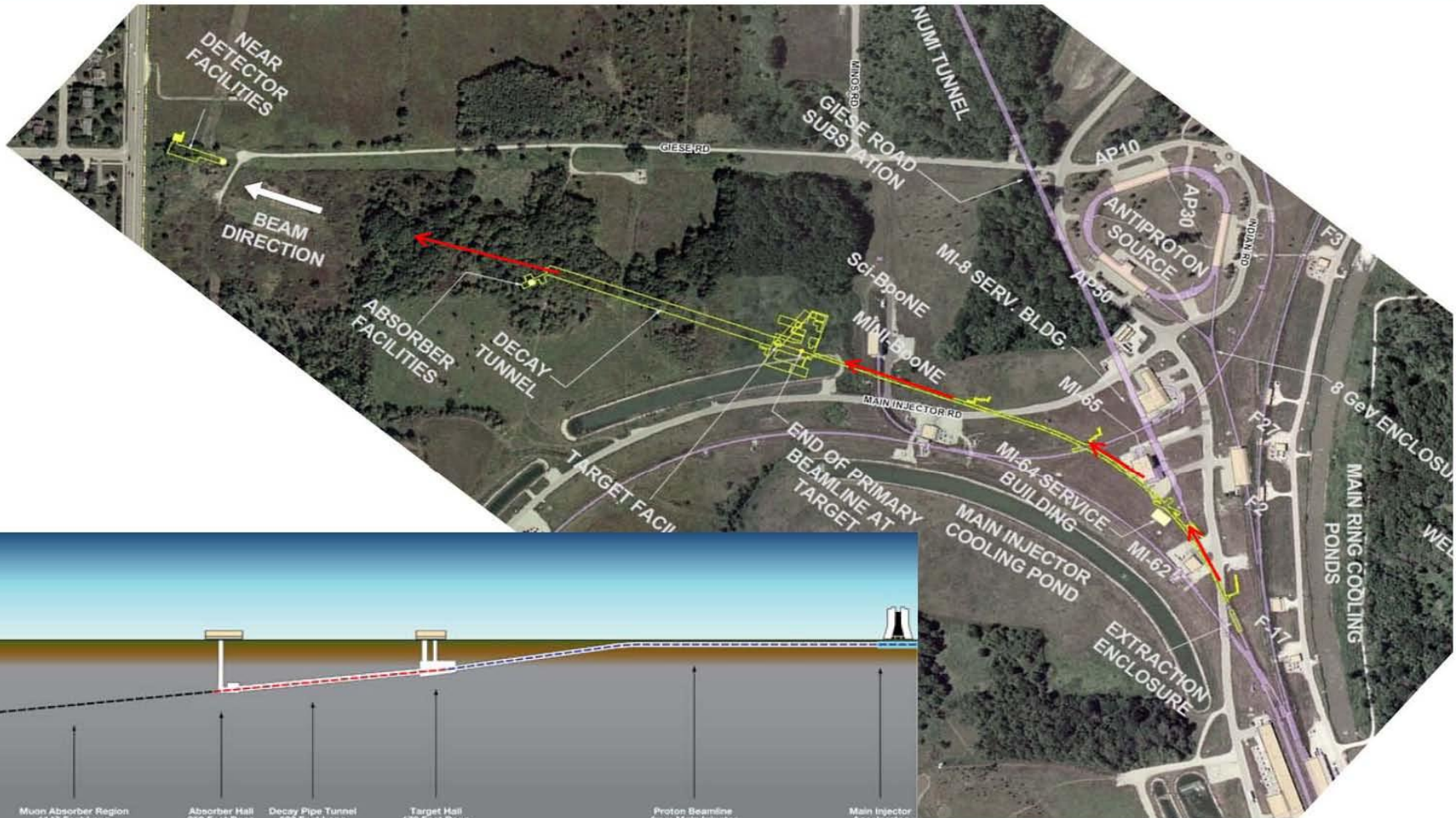

Long-Baseline Neutrino Experiment

# DUSEL Lab Layout

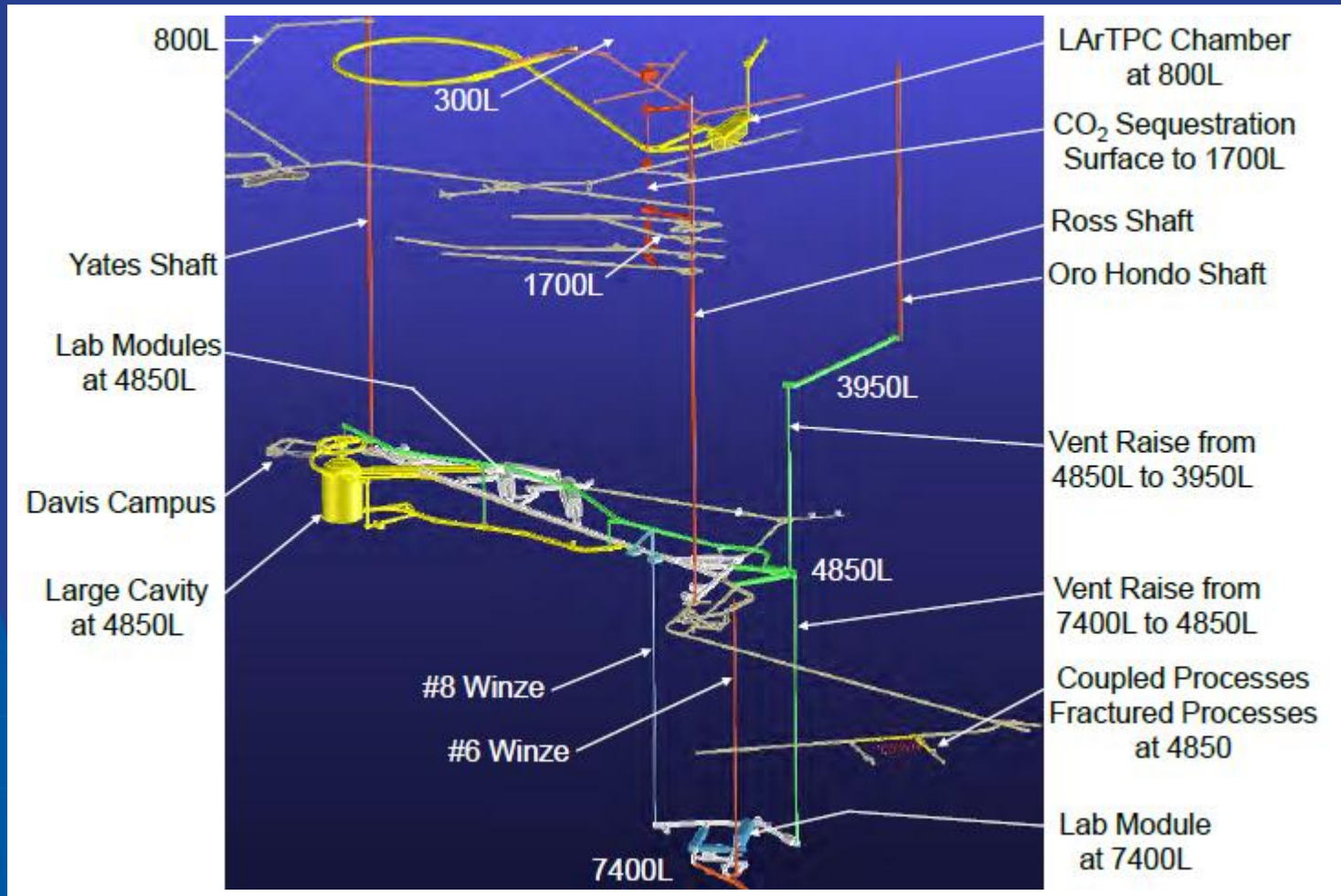

# Neutrino physics sensitivities

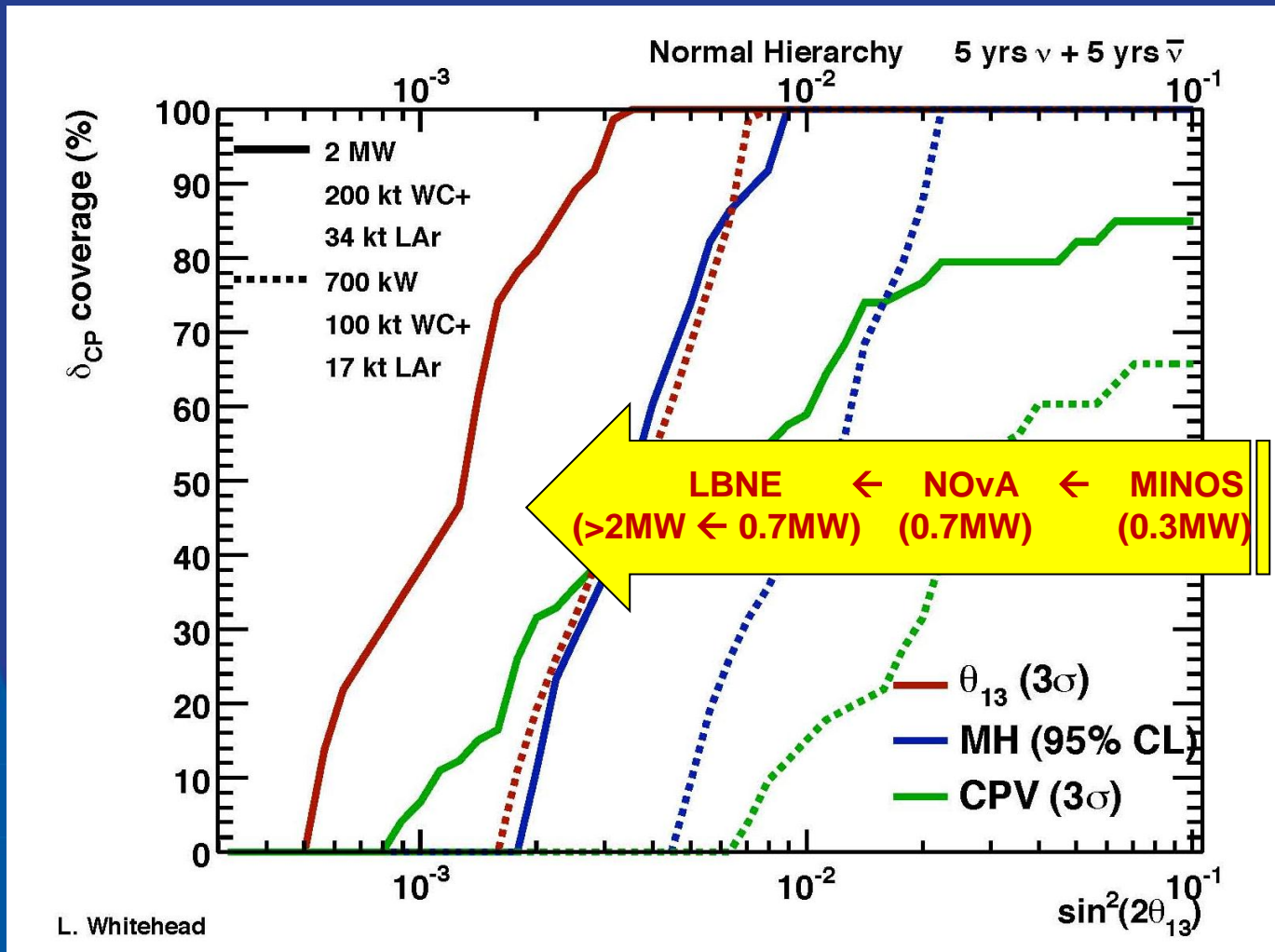

With Project X

# Consequences of NSF decision

- Couples the choice of technology to the development of the underground laboratory
- The infrastructure for LBNE enables other underground activities (dark matter searches, neutrino-less double beta decay) with the construction of a deep underground water Cerenkov
- The set of activities, LBNE, dark matter searches, neutrino-less double beta decay are long term projects with several generations of experiments
- In the long term we can have the best underground laboratory in the world because of the coupling to Fermilab

# What is the long term program?

- **In the longer term**, we want to drive the intensity frontier program with *Project X*:
  - with already built experiments (LBNE, short base-line neutrino experiments, g-2);
  - modified experiments (Mu2e);
  - and new experiments (a series of kaon and muon experiments, measurement of EDMs in exotic nuclei); and applications to other programs
- It is important to declare our intent to build this program both with LBNE (already has CD-0) and *Project X* (needs CD-0) as the main anchors so that we can build the needed international collaborations, especially with Europe and Asia

# Project X Reference Design

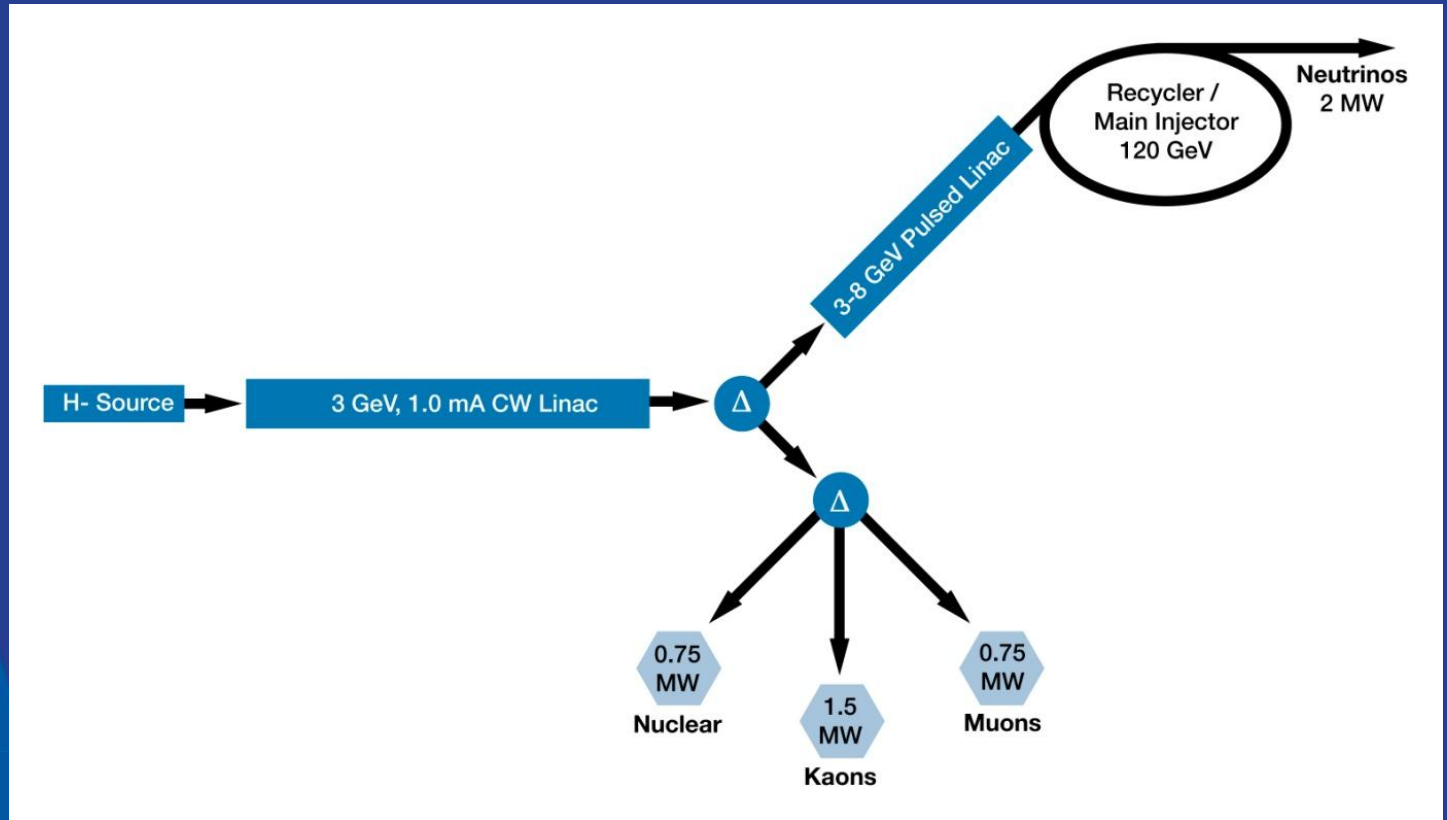

# Project X Siting

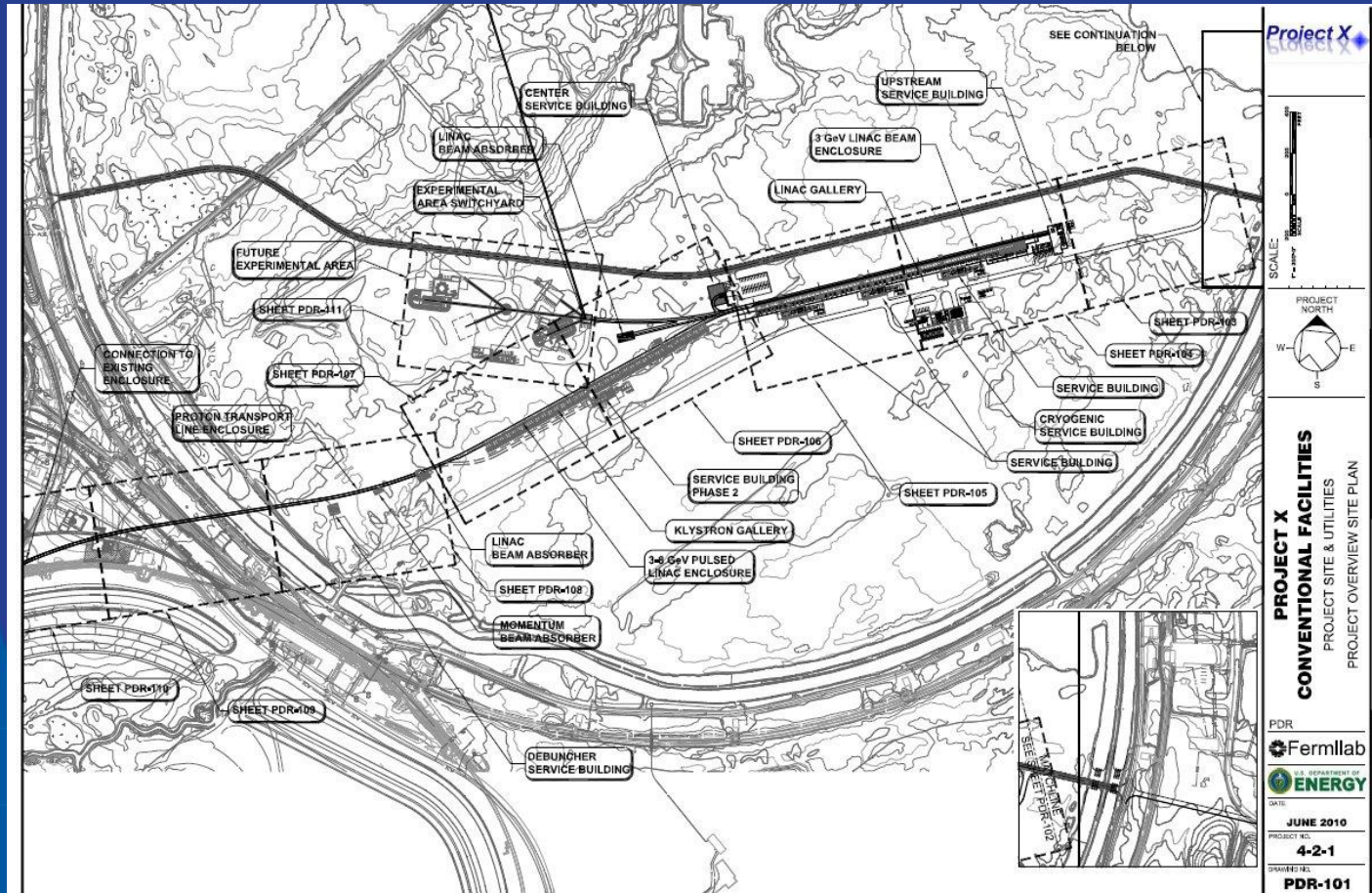



# *Project X: CW linac*

- Unique facility for rare decays: a continuous wave (CW), very high power, superconducting 3 GeV linac. Will not exist anywhere else
- CW linac greatly enhances the capability for rare decays of kaons, muons
- CW linac is the ideal machine for other uses: Standard Model tests with nuclei (ISOL targets), possible energy and transmutation applications, cold neutrons

# $K \rightarrow \pi \nu \bar{\nu} \dots$ Past, Present, Future

Facility (Experiment)	Proton Power	Kaon decay rate	Kaon Properties	$K \rightarrow \pi \nu \bar{\nu}$ Sensitivity
BNL AGS (E787/E949)	50kW	$1 \times 10^6$ K <sup>+</sup> /sec	Pure stopped K <sup>+</sup> source	7 events (charged)
CERN (NA62)	20kW	$10 \times 10^6$ K <sup>+</sup> /sec	Un-separated 1- GHz K <sup>+</sup> /p <sup>+</sup> /p <sup>+</sup> beam	80 events (charged)
<i>Project X</i> K <sup>+</sup> $\rightarrow$ $\pi \nu \bar{\nu}$	1500 kW	$100 \times 10^6$ K <sup>+</sup> /sec	Pure stopped K <sup>+</sup> source	>1000 events (charged)
JPARC (KOTO)	<300 kW	< $0.5 \times 10^6$ K <sub>L</sub> /sec	Pencil beam	1 event (neutral)
<i>Project X</i> K <sub>L</sub> $\rightarrow$ $\pi \nu \bar{\nu}$	1500kW	$50 \times 10^6$ K <sub>L</sub> /sec	Pencil beam & Precision TOF	1000 events (neutral)

# $\mu^-A \rightarrow e^-A$ Conversion... (Past, Present, Future)

Facility (Experiment)	Proton Power	Stopped Muon rate	Muon Properties	$\mu A \rightarrow e A$ Sensitivity
PSI (SINDRUM II)	1000 kW	$10^7$ m/sec	“DC” (50 MHz cyclotron) 52 +/- 1 MeV/c	$3 \times 10^{-13}$
Booster & JPARC (Mu2e/COMET)	25 kW	$5 \times 10^{10}$ m/sec	1 MHz Pulsed 10-70 MeV/c	$2 \times 10^{-17}$
<i>Project X</i> (PRISM-like)	1000 kW	$> 10^{12}$ m/sec	Pulsed, narrow-band (30 +/- 1 MeV/c)	$< 10^{-18}$

Mu2e/COMET breakthrough technology:

- Large muon yield from production target *inside* of high field solenoid.
- Pulsed beam strongly suppresses pion backgrounds.

*Project X* breakthrough technology:

- Collapse the high flux wide-band muon beam to a narrow-band beam with cooling techniques.

# Interplay: LHC ↔ Intensity Frontier

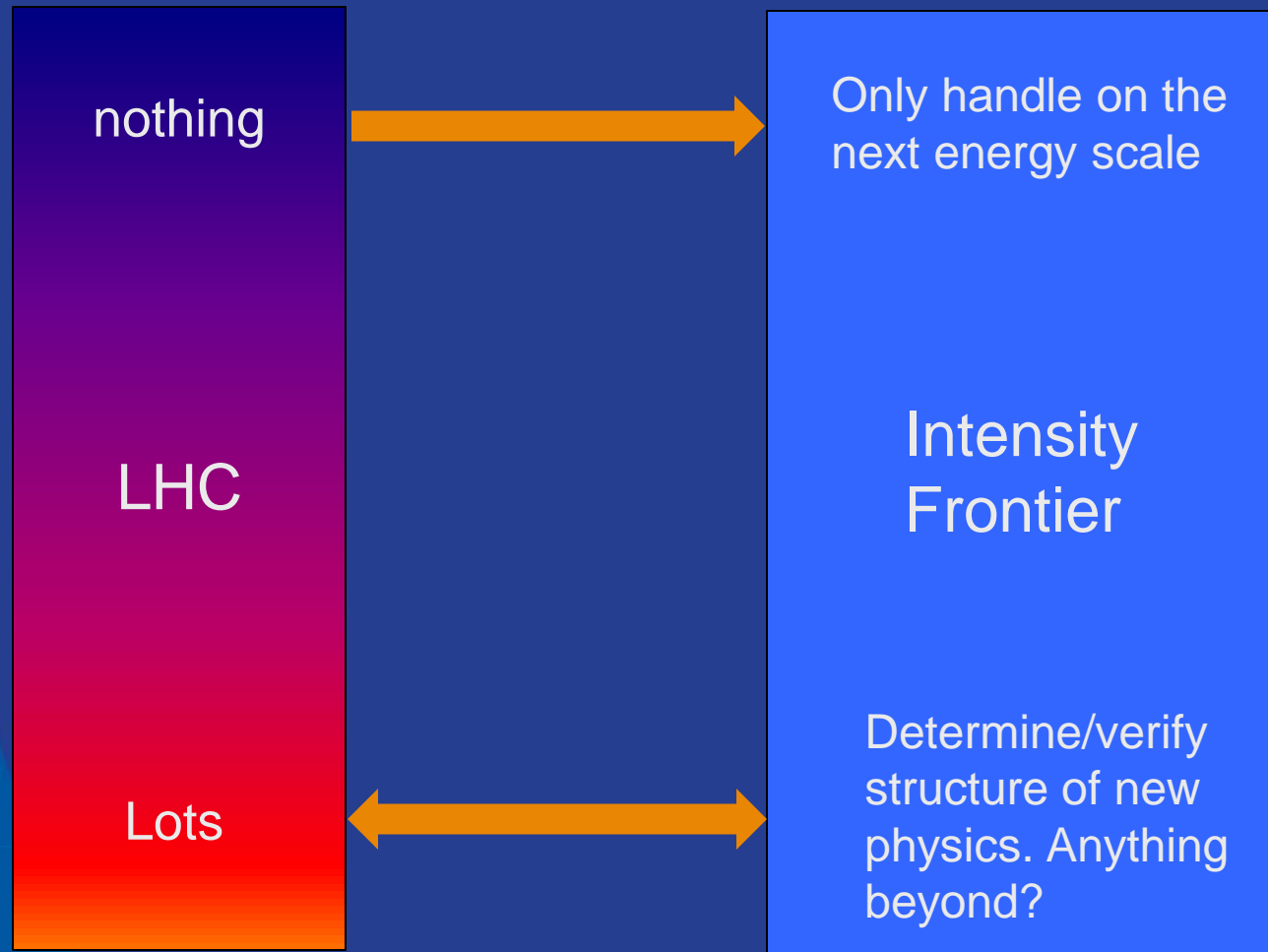

# Large effects in kaon decay rates

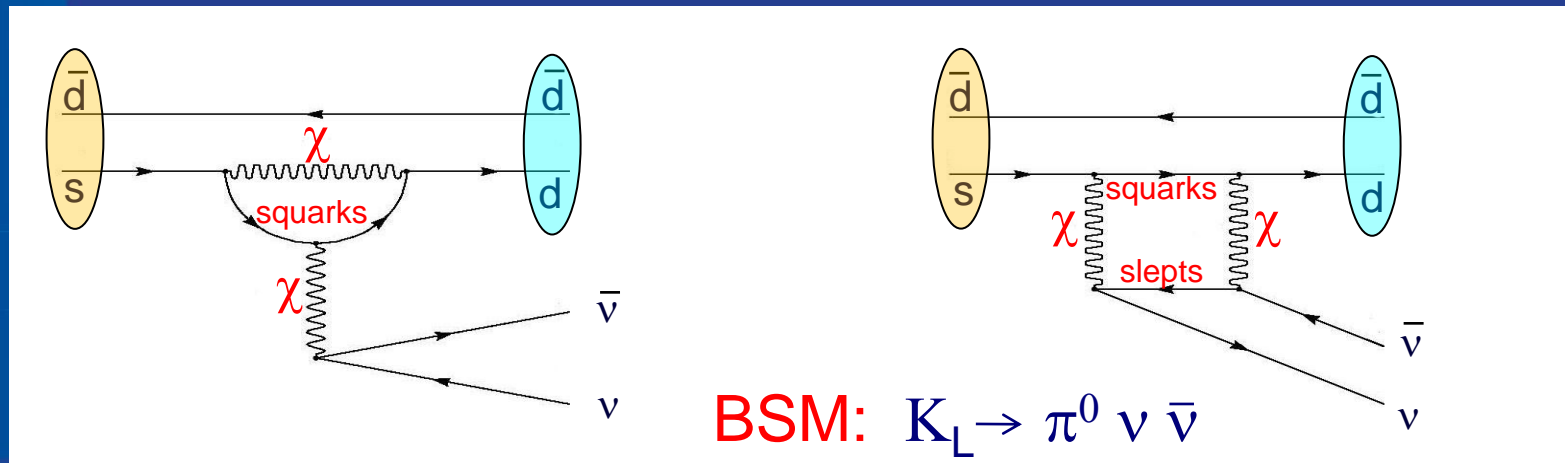
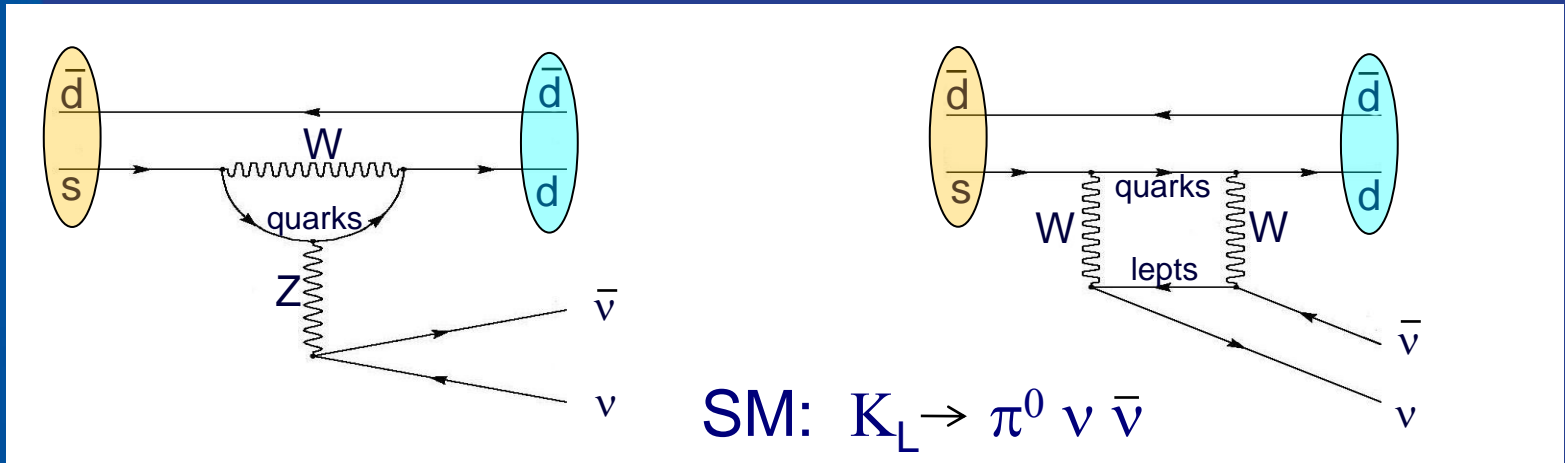

# Comparison of Sensitivity to New Physics Models (a la Prof. Dr. A. Buras at TUM)

	AC	RVV2	AKM	$\delta$ LL	FBMSSM	LHT	RS
$D^0 - \bar{D}^0$	★★★	★	★	★	★	★★★	?
$\epsilon_K$	★	★★★★	★★★★	★	★	★★	★★★★
$S_{\psi\phi}$	★★★	★★★★	★★★★	★	★	★★★	★★★★
$S_{\phi K_S}$	★★★	★★	★	★★★★	★★★★	★	?
$A_{CP}(B \rightarrow X_s \gamma)$	★	★	★	★★★★	★★★★	★	?
$A_{7,S}(B \rightarrow K^* \mu^+ \mu^-)$	★	★	★	★★★★	★★★★	★★	?
$A_9(B \rightarrow K^* \mu^+ \mu^-)$	★	★	★	★	★	★	?
$B \rightarrow K^{(*)} \nu \bar{\nu}$	★	★	★	★	★	★	★
$B_s \rightarrow \mu^+ \mu^-$	★★★	★★★★	★★★★	★★★★	★★★★	★	★
$K^+ \rightarrow \pi^+ \nu \bar{\nu}$	★	★	★	★	★	★★★★	★★★★
$K_L \rightarrow \pi^0 \nu \bar{\nu}$	★	★	★	★	★	★★★★	★★★★
$\mu \rightarrow e \gamma$	★★★★	★★★★	★★★★	★★★★	★★★★	★★★★	★★★★
$\tau \rightarrow \mu \gamma$	★★★	★★★★	★	★★★★	★★★★	★★★	★★★★
$\mu + N \rightarrow e + N$	★★★★	★★★★	★★★★	★★★★	★★★★	★★★★	★★★★
$d_n$	★★★★	★★★★	★★★★	★★	★★★★	★	★★★★
$d_e$	★★★★	★★★★	★★	★	★★★★	★	★★★★
$(g-2)_\mu$	★★★★	★★★★	★★	★★★★	★★★★	★	?

← Different theoretical models

Table 8: “DNA” of flavour physics effects for the most interesting observables in a selection of SUSY and non-SUSY models ★★★ signals large effects, ★★ visible but small effects and ★ implies that the given model does not predict sizable effects in that observable.

W. Altmannshofer, A.J. Buras, S. Gori, P. Paradisi, D.M. Straub, Nucl.Phys.B830:17-94, 2010.

# Muon Particle Physics Programs at Project X

Mode	Beam	Current limit	planned goal	Project X goal	Priority
$\mu^- N \rightarrow e^- N$	pulsed	$<10^{-12}$	$3 \times 10^{-17}$	$3 \times 10^{-19}$	★★★
$\mu^+ \rightarrow e^+ \gamma$	DC	$<1.1 \times 10^{-12}$	$2 \times 10^{-13}$	$2 \times 10^{-14}$	★★
$\mu^* \rightarrow e^+ e^- e^-$	DC	$<10^{-12}$	-	$1 \times 10^{-16}$	★★
$\mu^- e^- N \rightarrow e^- e^- N$	DC	-		$1 \times 10^{-16}$	★★
Mu to $\bar{\mu}$ conv	pulsed	$<8 \times 10^{-11}$		$<5 \times 10^{-15}$	★★
muon EDM	pulsed	$<1.8 \times 10^{-19}$		$<5 \times 10^{-25}$	★★★
muon lifetime	pulsed	1ppm		0.1ppm	★

# *Project X* is central to the strategy

- The CW linac coupled to an 8 GeV pulsed LINAC and to the Recycler and Main Injector, gives the most intense beams of neutrinos at high energy (LBNE) and low energy (for the successors to Mini and MicroBooNE)
- Makes use of modern accelerators at Fermilab (Recycler and Main Injector) and its scope would be difficult to reproduce elsewhere without this established base
- Eliminates proton economics as the major limitation: all experiments run simultaneously



# *Project X* and other projects

- *Project X* benefits from the world-wide ILC R&D: SCRF and photo-e cloud. SCRF R&D positions the US to play a leading role in ILC.
- Capabilities and infrastructure developed for *Project X* will be useful for other domestic non HEP projects.
- *Project X* with upgrades can be the front end of a neutrino factory or a muon collider, opening paths for development of the intensity frontier and a road back to the energy frontier

# “Plug and play” - physics

3 GeV CW linac	<ul style="list-style-type: none"><li>• Muons</li><li>• Kaons</li><li>• Nuclei (ISOL)</li><li>• Materials (ADS)</li></ul>
3-8 GeV pulsed linac	<ul style="list-style-type: none"><li>• Neutrinos vs. antineutrinos</li><li>• Muons</li></ul>
8-120 GeV existing machines	<ul style="list-style-type: none"><li>• Long base line neutrino oscillations</li></ul>

# Sequencing is flexible

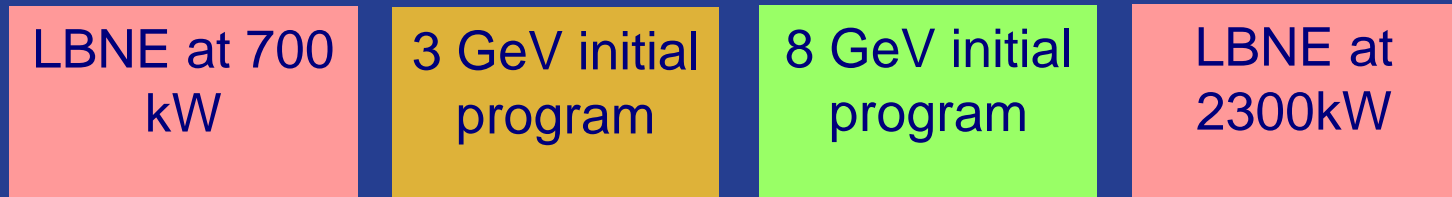

We are capable of doing the whole program at once in the next ten years, or it can be sequenced over a longer period. First part, LBNE, \$1.4B with underground development, contingency and escalation.

# Fermilab accelerator strategy

To create a world-leading program at the Intensity Frontier...and use this program as a bridge to an Energy Frontier facility



**Fundamental Accelerator Science and Technology Development**

# How to think about total program ?

- Total cost of *Project X* + LBNE + day one intensity frontier experiments (on the same time frame SNS would be \$2.2B).... \$3.5B
- Offsets: India + Europe + China(?) + NSF (\$0.85B)
- Net cost for the DOE..... \$2.65B
- In present Fermilab budget: ramp down of NOvA and Tevatron times ten years..... (\$0.9B)
- Net additional investment on HEP over ten years for the entire program \$1.75B

# Accelerator activities: aligned with mission



## Accelerator Science

- Advanced Accelerator R&D Program
- Collimation
- Ionization cooling
- Beam dynamics and simulation



## Accelerator Technology Development

- High field magnets
- Superconducting RF
- RF Systems
- Cooling tech.
- Beam Instrumentation



## Future Facilities

- *Project X*
- Muon Collider
- ILC

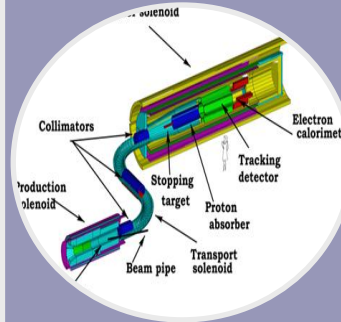

## Expanding Capability

- Proton Improvement Plan
- NOvA Upgrades
- High-power Targetry
- Mu2e and g-2
- LBNE



## Accelerator Operations

- Tevatron Colliding Beams
- 120 GeV Neutrino Program
- 8 GeV Neutrino Program

# From *Project X* to Neutrino Factory and Muon Collider

## Project X

Accelerate hydrogen ions to 8 GeV using SRF technology.

## Compressor Ring

Reduce size of beam.

## Target

Collisions lead to muons with energy of about 200 MeV.

## Muon Cooling

Reduce the transverse motion of the muons and create a tight beam.

## Initial Acceleration

In a dozen turns, accelerate muons to 20 GeV.

## Recirculating Linear Accelerator

In a number of turns, accelerate muons up to 2 TeV using SRF technology.

## Collider Ring

Located 100 meters underground. Muons live long enough to make about 1000 turns.

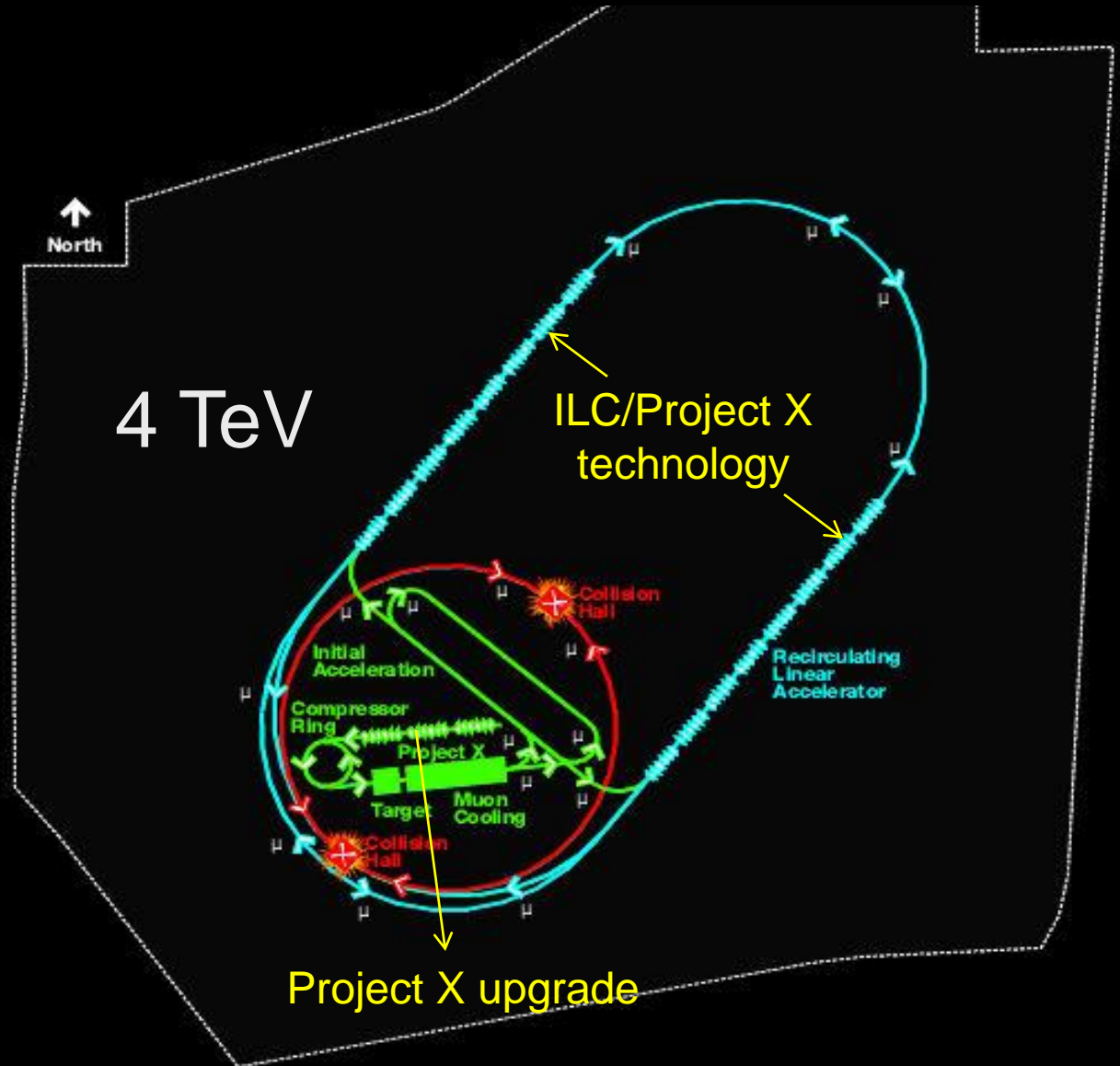

# What do we need from DOE

- Support the development of world-class facilities in the domain we propose. It is the most cost effective way for the US to maintain a leadership position in the world of HEP
  - **LBNE**: continue to develop the underground option: following the CD-1, CD-2, CD-3.....route, now using LBNE as vehicle for future development of the underground. Politically we need the Office of Science to advocate with the administration for this program – we can do our part as well. We understand it is a very difficult time to do this
  - **Project X**: provide CD-0 to help us develop a strong international collaboration; continue with the R&D to be ready to start construction in a few years
  -



# What do we need from DOE

- The financial pendulum swings: **start with LBNE** and **sequence *Project X*** as appropriate to circumstances at the time.
- Support the interim program that runs before *Project X*, to maintain the productivity of Fermilab during the rest of the decade. This involves full operations of the accelerator complex, the near term improvements, and the development of the planned experiments.
- We need your help with the public perception that we are shutting down Fermilab: means understanding and supporting the near term program.

# Additional Material

# Future program: at the three frontiers

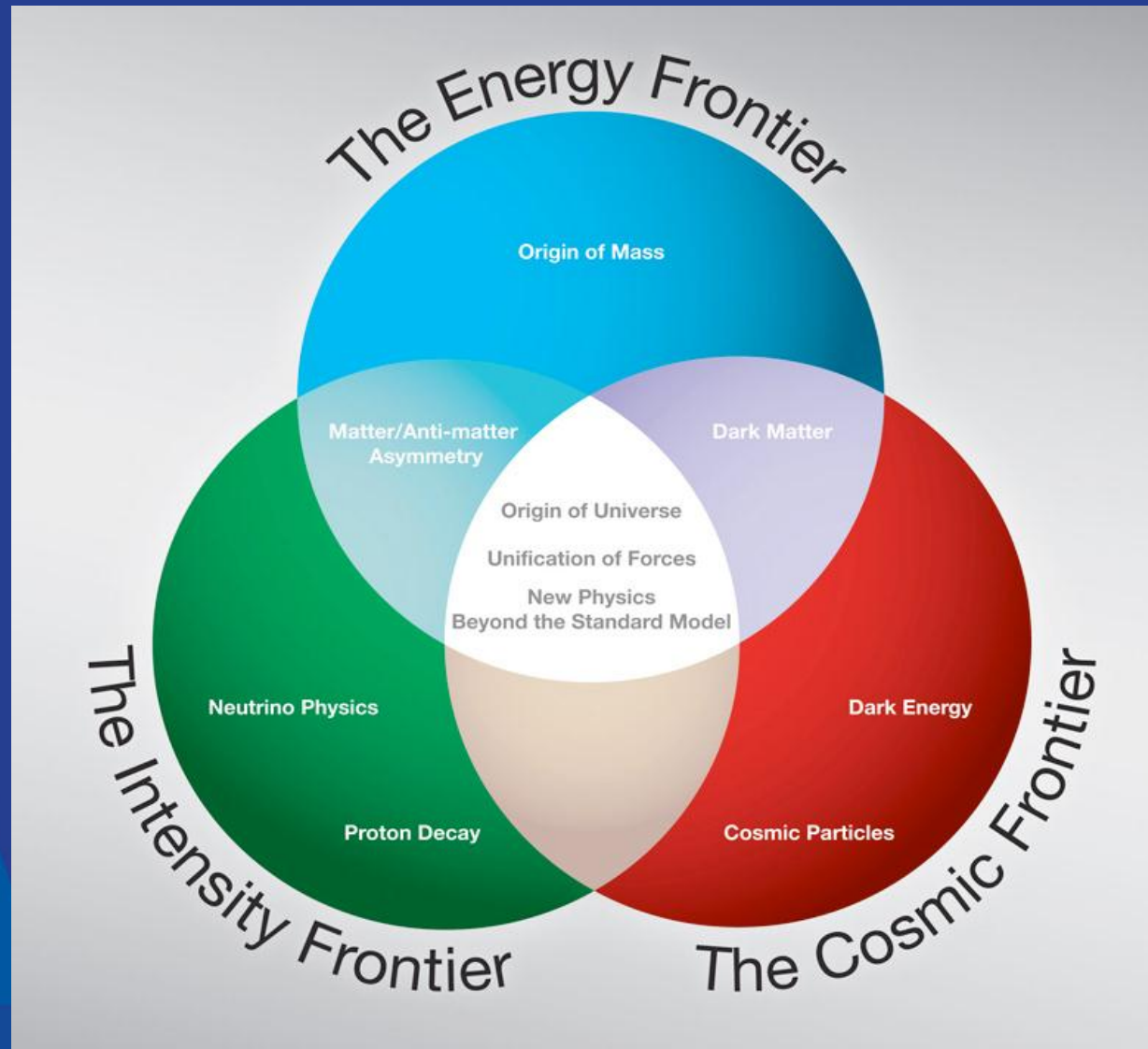

# Gaps and roles: energy frontier

- Next two decades: dominated by LHC. Upgrades to machine and detectors
- Biggest gap: what follows the LHC? Depends on results and at what energy results occur
- Fermilab strategy: completion of the Tevatron program and physics exploitation and upgrades of LHC. R&D on future machines: ILC if at “low” energy; muon collider if at high energy; new high field magnets for extension of LHC or future proton colliders at ultra-LHC energies

# Roles: energy frontier

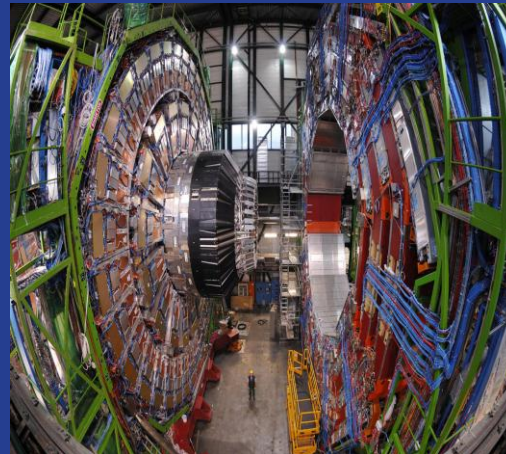
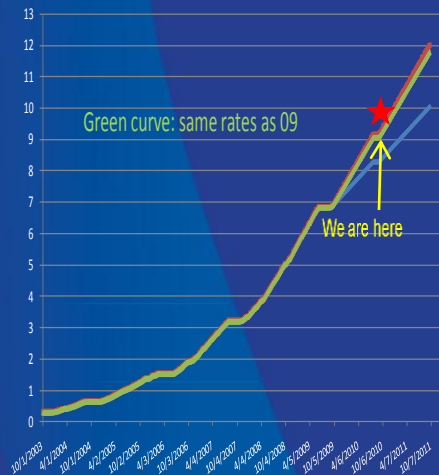

# Gaps and roles: cosmic frontier

- The principal connection to particle physics today: the nature of dark matter and dark energy
- Gap in the direct search for dark matter: get to “zero—background” technology. Gap in understanding dark energy is establishment of time evolution of the acceleration: new major telescopes (ground and space)
- Fermilab strategy: establish scalable “zero-background” technology for dark matter. Commission and exploit DES. Participate in future ground and space telescopes (the principal agencies are NSF and NASA, not DOE)

# Roles: cosmic frontier



<p>DM: ~10 kg DE: SDSS P. Auger</p>	<p>DM: ~100 kg DE: DES P. Auger Holometer?</p>	<p>DM: ~1 ton DE: LSST WFIRST?? BigBOSS??</p>	<p>DE: LSST WFIRST??</p>
---	--	---	------------------------------

Now

2013

2016

2019

2022

# Gaps and roles: intensity frontier

- Two principal approaches: 1) proton super-beams to study neutrinos and rare decays and 2) quark factories: in  $e^+e^-$  and LHCb
- Principal gap is the understanding of neutrinos and the observation of rare decays coupled to new physics processes
- Fermilab strategy: develop the most powerful set of facilities in the world for the study of neutrinos and rare processes, well beyond the present state of the art. Complementary to LHC and with discovery potential beyond LHC. DOE has the central role. Will define the role of US facilities in the world's program.



# Roles: intensity frontier

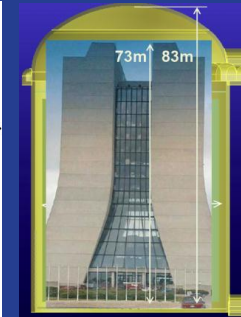
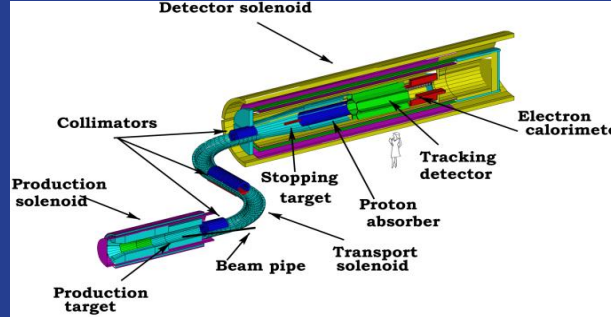
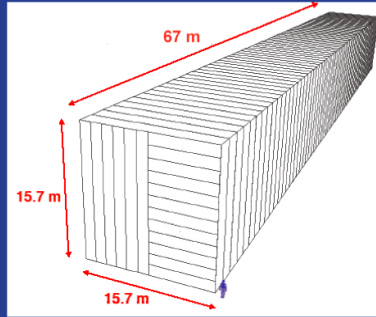
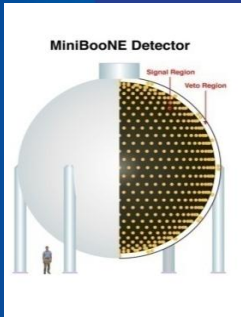

<p>MINOS MiniBooNE MINERvA SeaQuest</p>	<p>NOvA MicroBooNE g-2 MINERvA MINOS SeaQuest</p>	<p>NOvA g-2 LBNE Mu2e</p>	<p>Project X+LBNE <math>\mu</math>, K, nuclear, ... <math>\nu</math> Factory ??</p>
---	---	---------------------------------------	---

Now

2013

2016

2019

2022

