

$$\mu \rightarrow eee$$

Experimental Aspects



Niklaus Berger

Institut für Kernphysik, Johannes-Gutenberg Universität Mainz
for the Mu3e Collaboration

RF5: CLFV
July 2020

Overview



A look back:

- The SINDRUM experiment

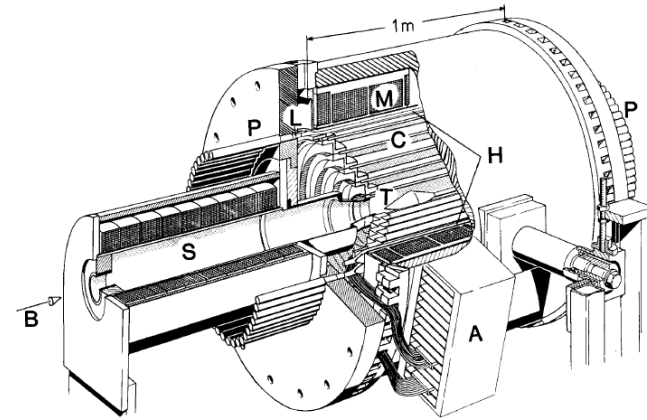

The Mu3e experiment:

- A fast, thin, high resolution detector for $> 10^8$ muon decays/s

Beyond Mu3e:

- Technological challenges

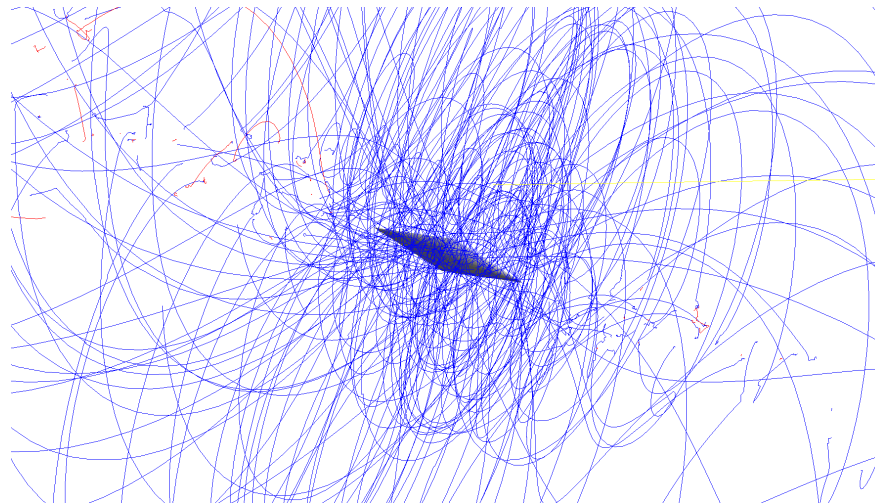
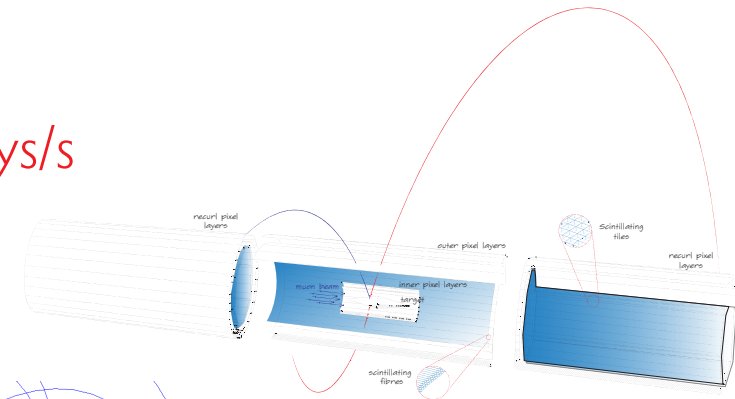

Muon lepton flavour violation experiments

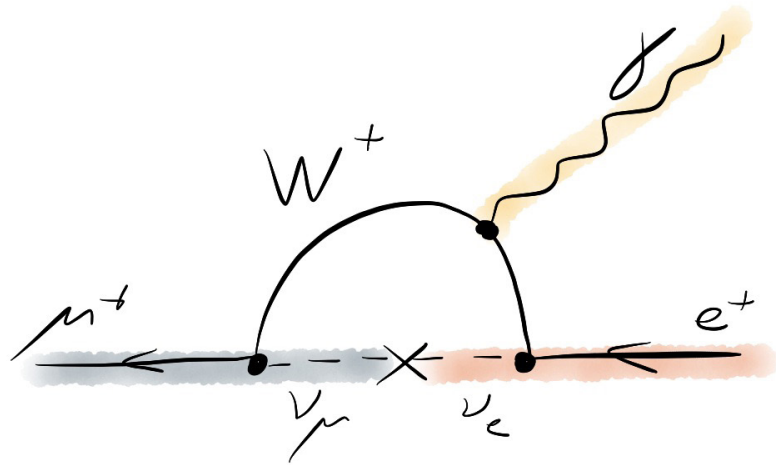

Standard Model branching fractions of

10^{-50} ish

Only limited by number of muons
and background suppression:

Experimental/technical challenge



Searching for $\mu^+ \rightarrow e^+e^-e^+$

The signal

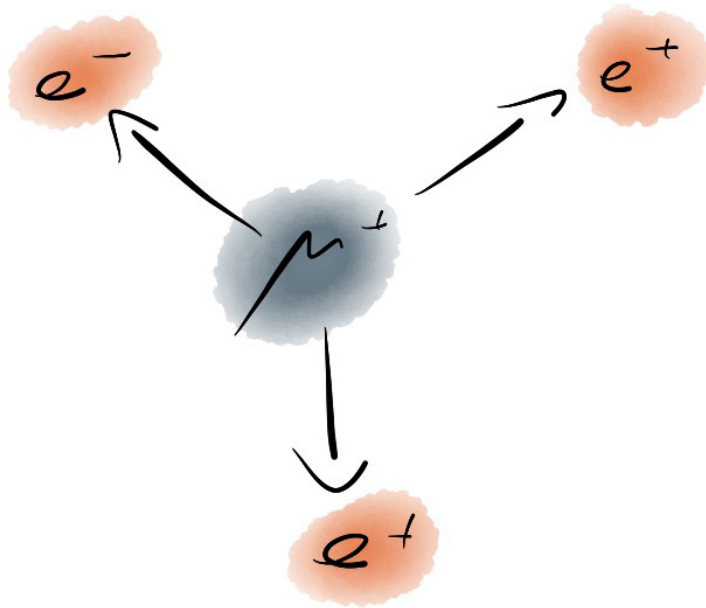

- $\mu^+ \rightarrow e^+e^-e^+$
- Two positrons, one electron
- From same vertex
- Same time
- $\sum p_e = m_\mu$
- Maximum momentum: $\frac{1}{2} m_\mu = 53 \text{ MeV}/c$

Accidental Background

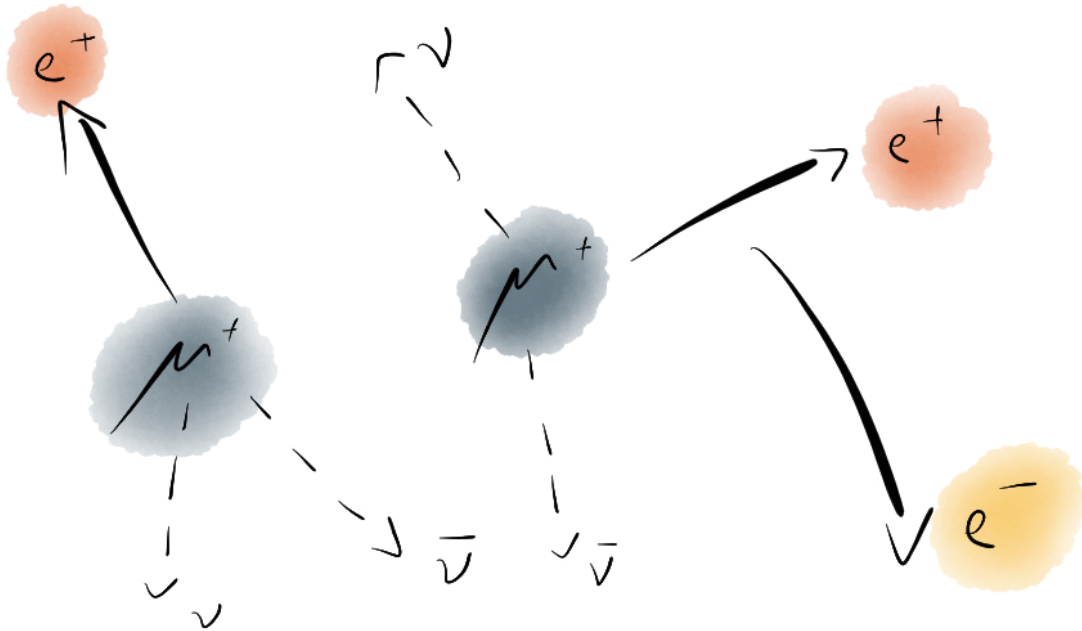

- Combination of positrons from ordinary muon decay with electrons from:
 - photon conversion,
 - Bhabha (electron-positron) scattering,
 - Mis-reconstruction
- Need very good timing, vertex and momentum resolution
- Need a continuous beam (PSI...)

Internal conversion background



- Allowed radiative decay with internal conversion:



- Only distinguishing feature:
Missing momentum carried by neutrinos



- Need excellent momentum resolution

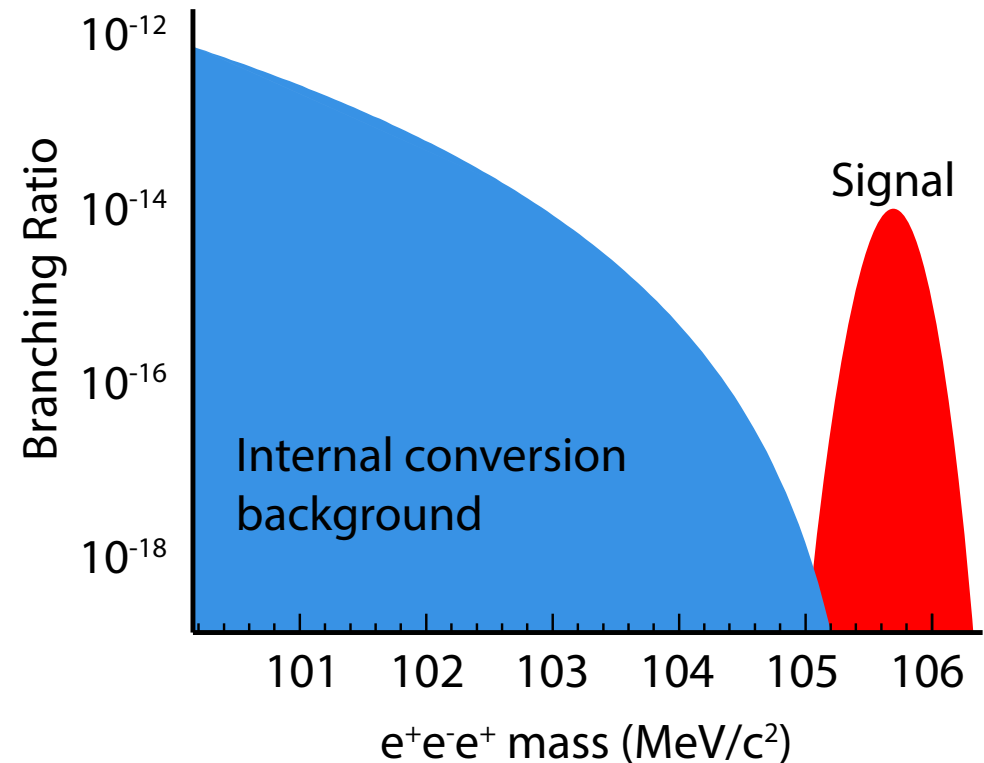



Searching for $\mu^+ \rightarrow e^+e^-e^+$:

SINDRUM

SINDRUM

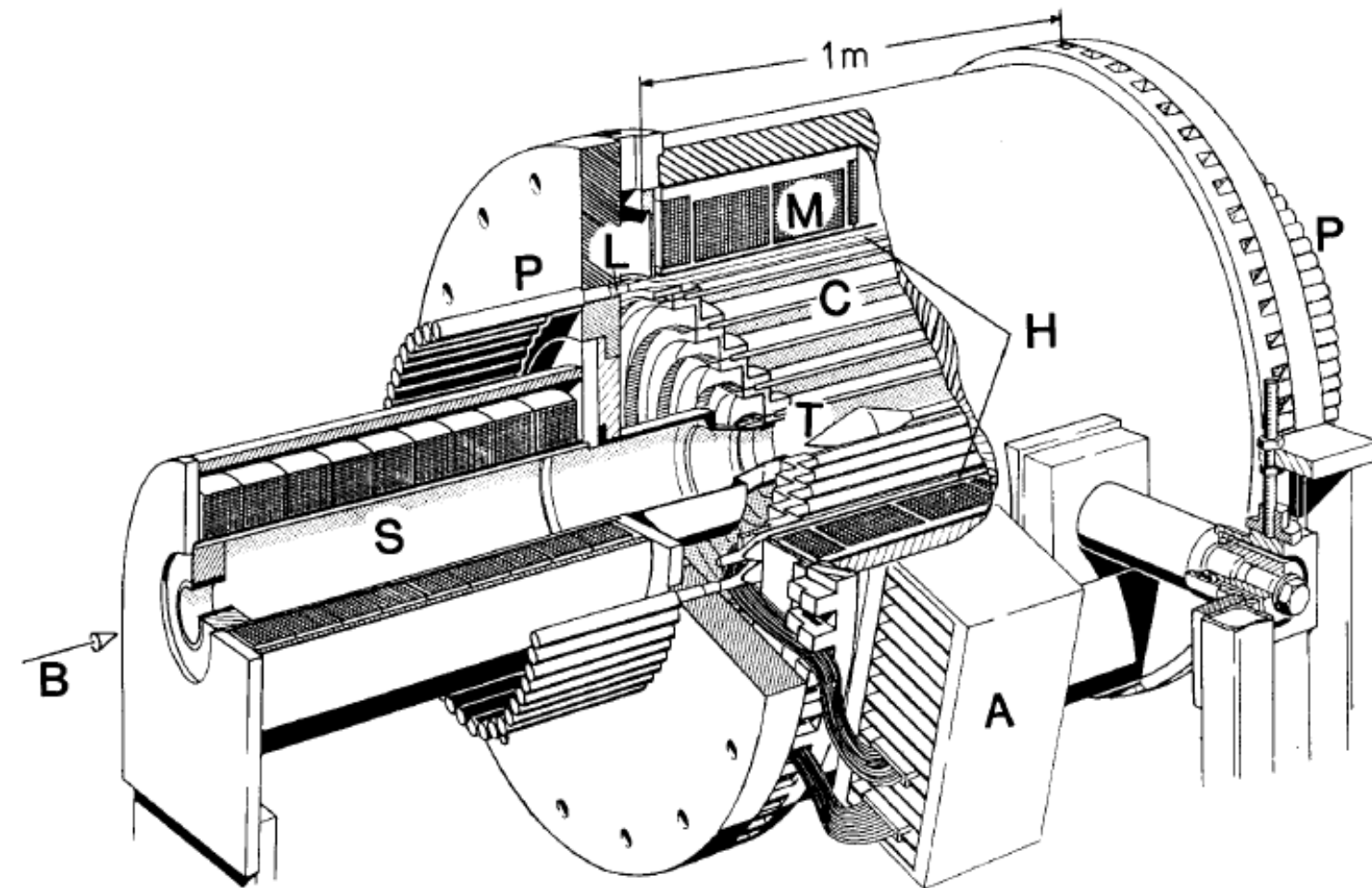

B: Muon Beam

S: Focusing Solenoid

T: Target

C: Five cylindrical multiwire
proportional chambers

H: Scintillator hodoscope

L: Light-guides

P: Photomultipliers

A: Preamplifiers

M: Magnet coil
(normal conducting,
0.6 T)

Data taking 1983 - 1986

Up to 5×10^6 μ stops/s

SINDRUM

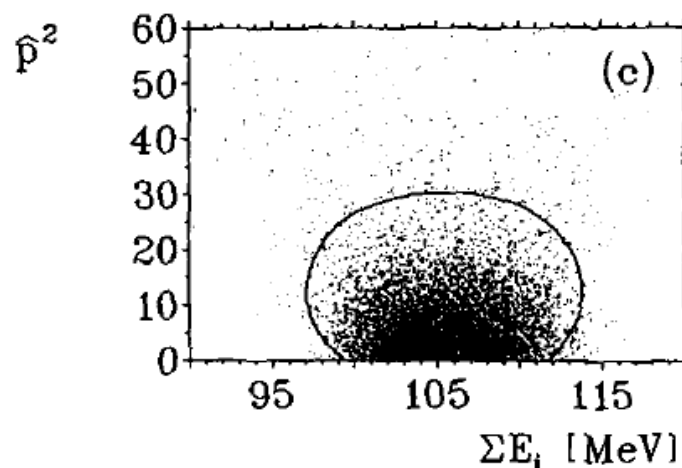
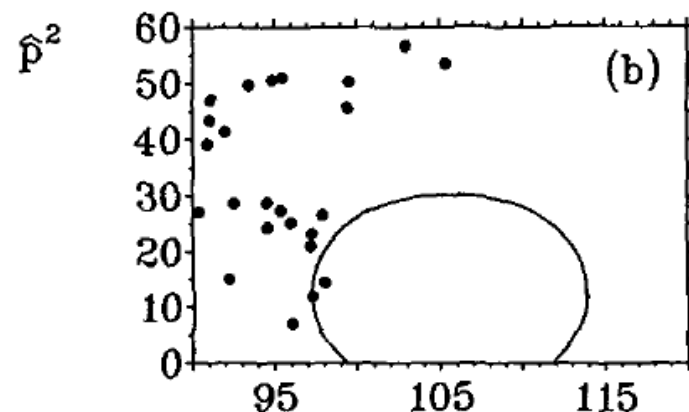
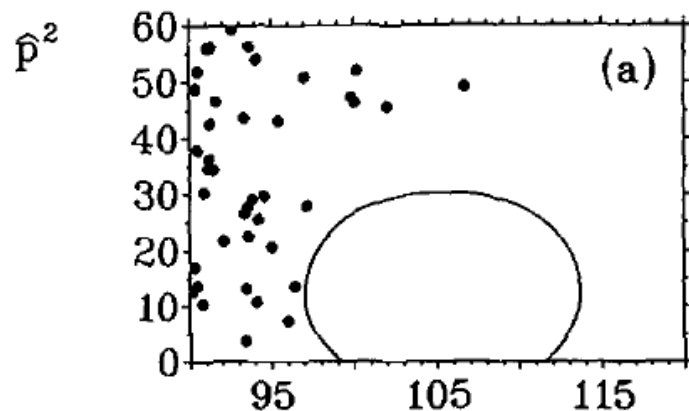

Results:

(Resolution weighted momentum of the CMS system vs. sum of the three electron energies)

(a) Coincident events - 60% accidentals, 40% internal conversion

(b) Accidentals

(c) Signal MC with 95% contour

$$B(\mu^+ \rightarrow e^+e^-e^+) < 1.0 \cdot 10^{-12}$$

Probably some more potential in the apparatus, ultimately limited by rate capability and momentum resolution



Need excellent momentum resolution
for very low momentum electrons

Momentum measurement

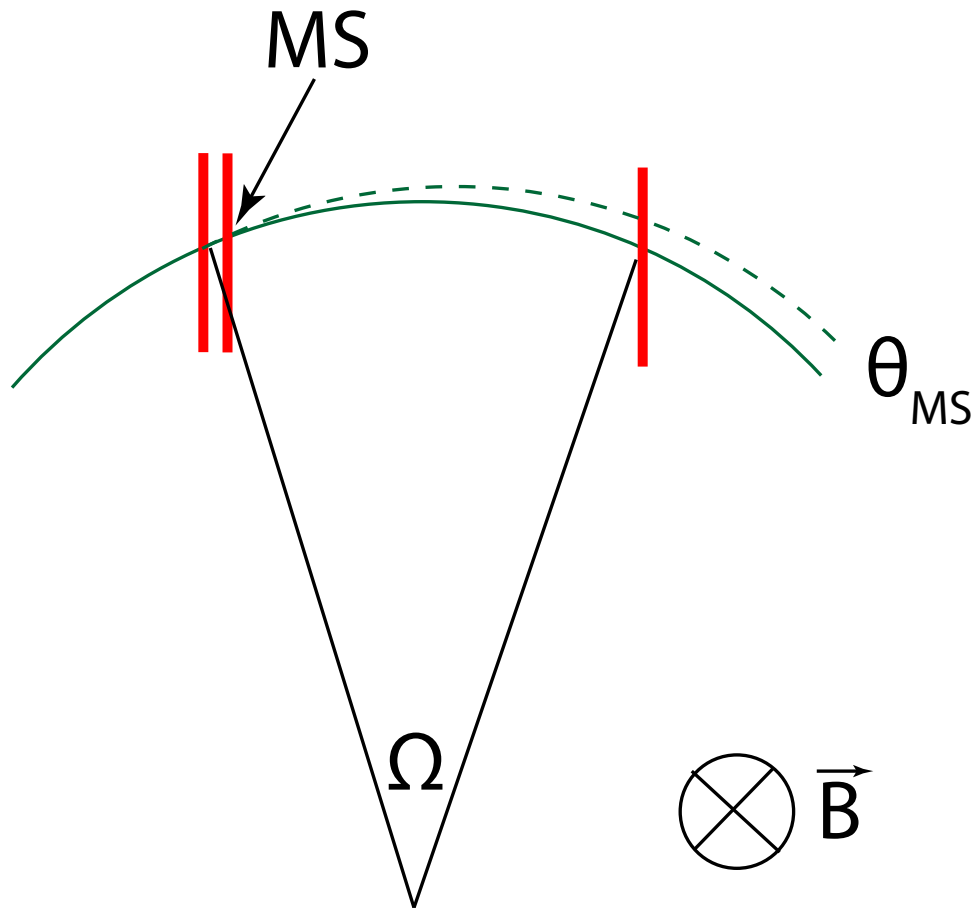

- Low momentum electrons/positrons
- Resolution dominated by **multiple scattering**
- Momentum resolution to first order:

$$\sigma_{p/p} \sim \theta_{MS}/\Omega$$

- Precision requires large lever arm (large bending angle Ω) and low multiple scattering θ_{MS}

Precision vs. Acceptance

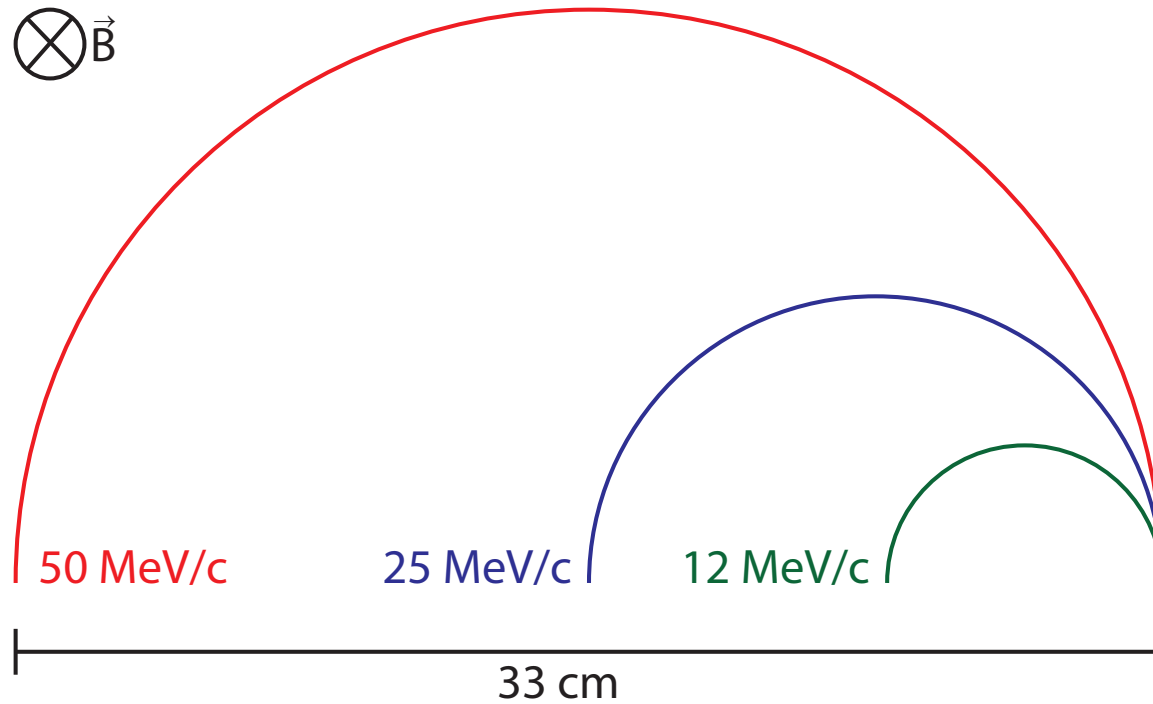

Precision vs. Acceptance

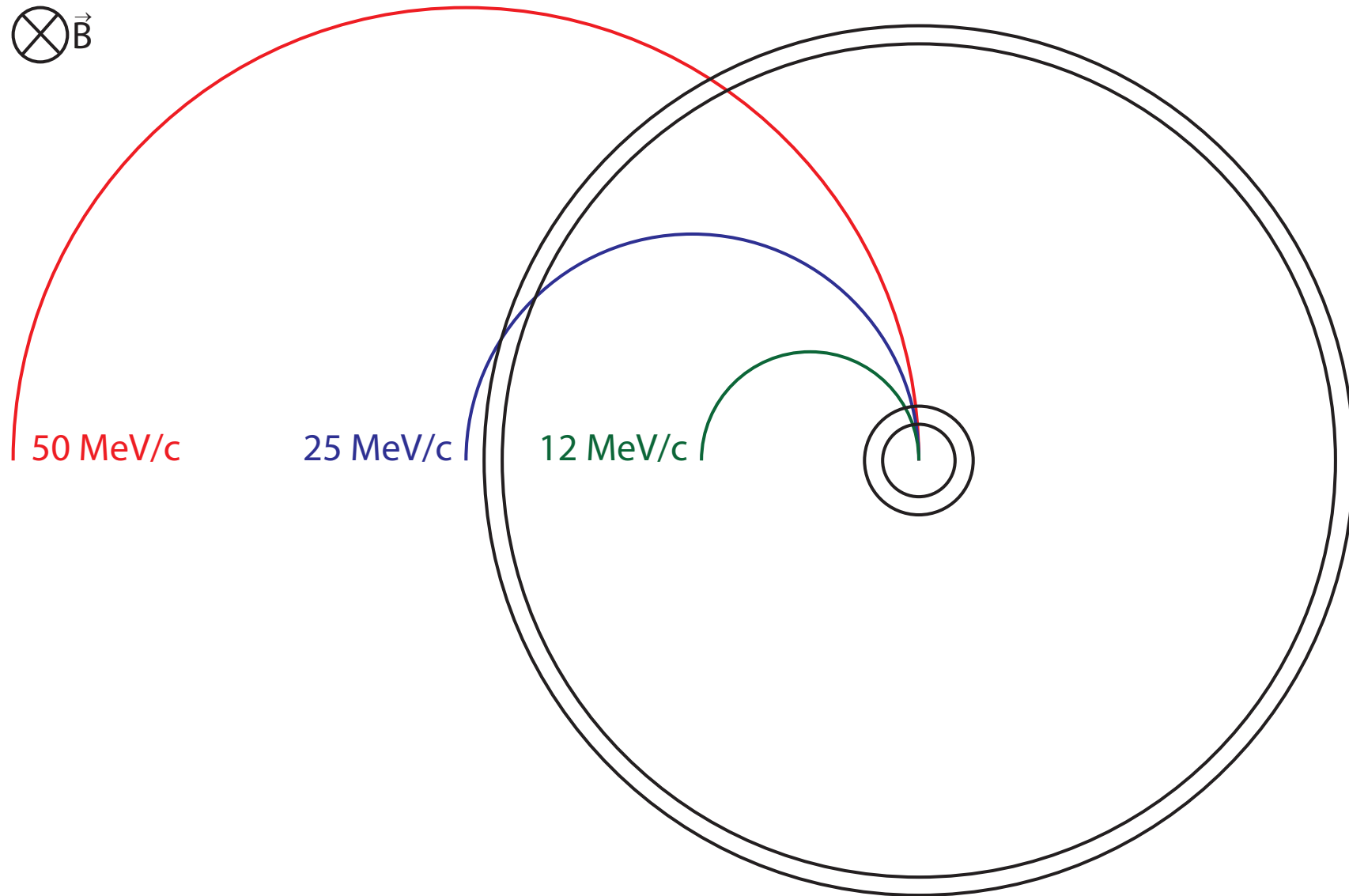

Precision vs. Acceptance

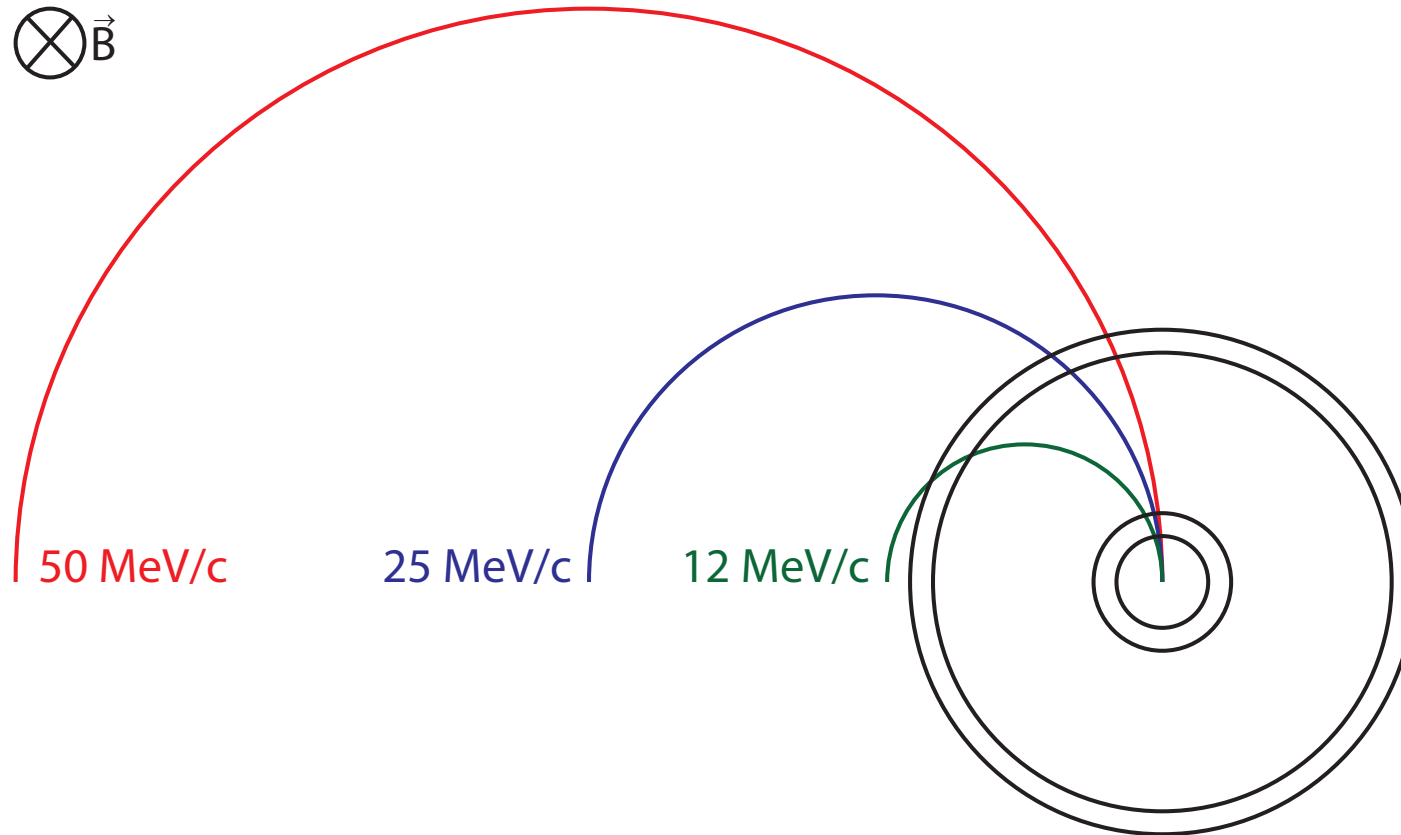

Precision vs. Acceptance

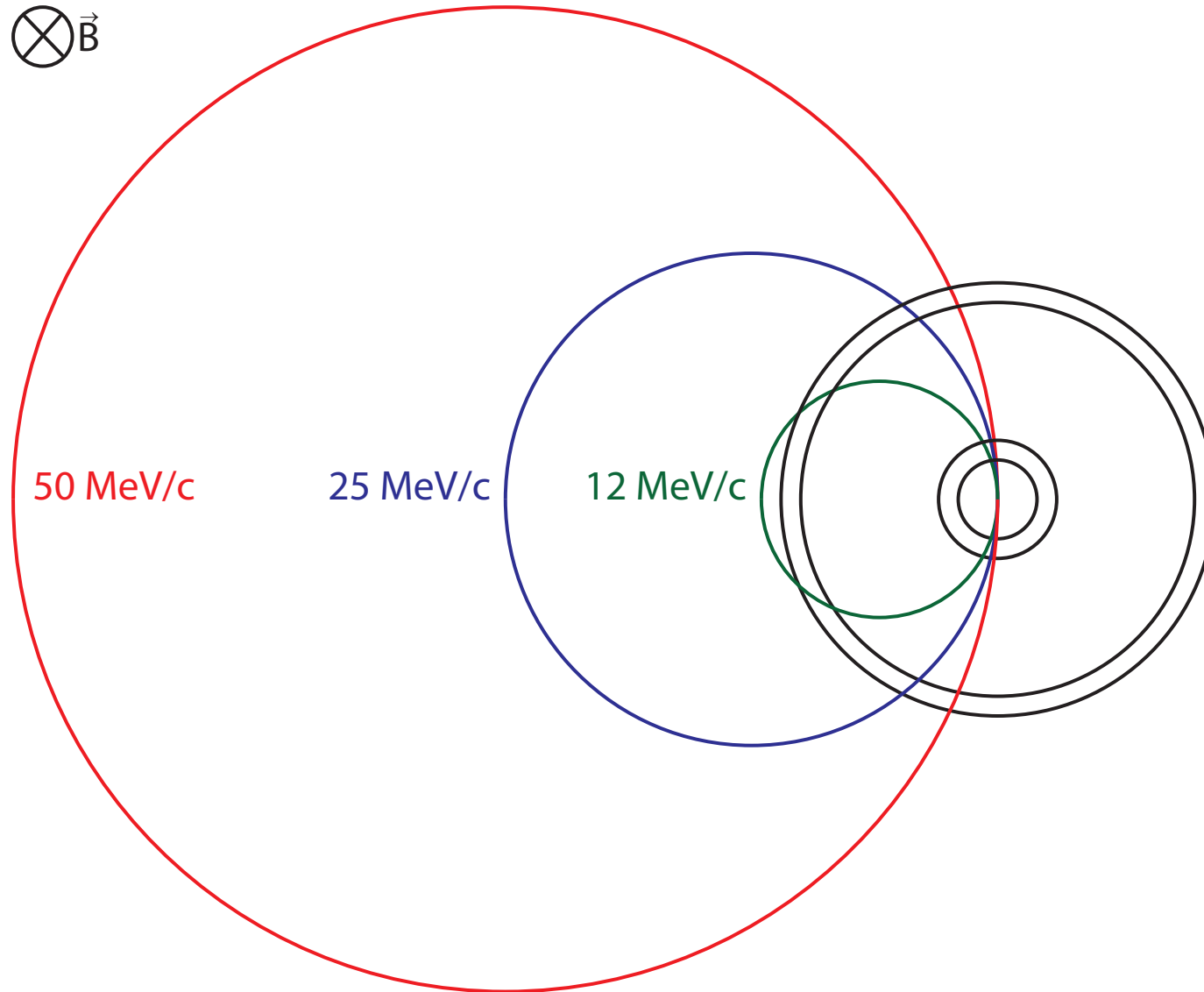

Detector Design



muon beam

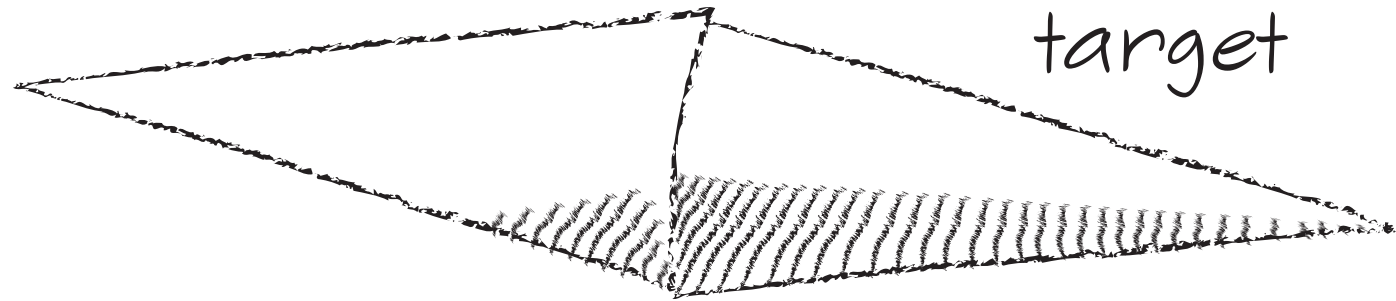
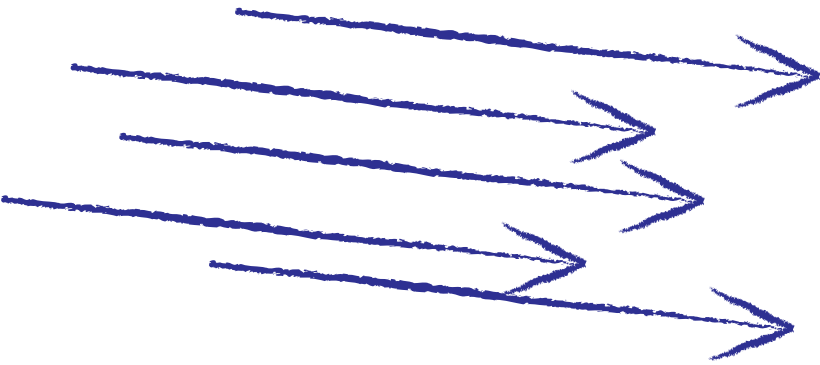

target

Detector Design

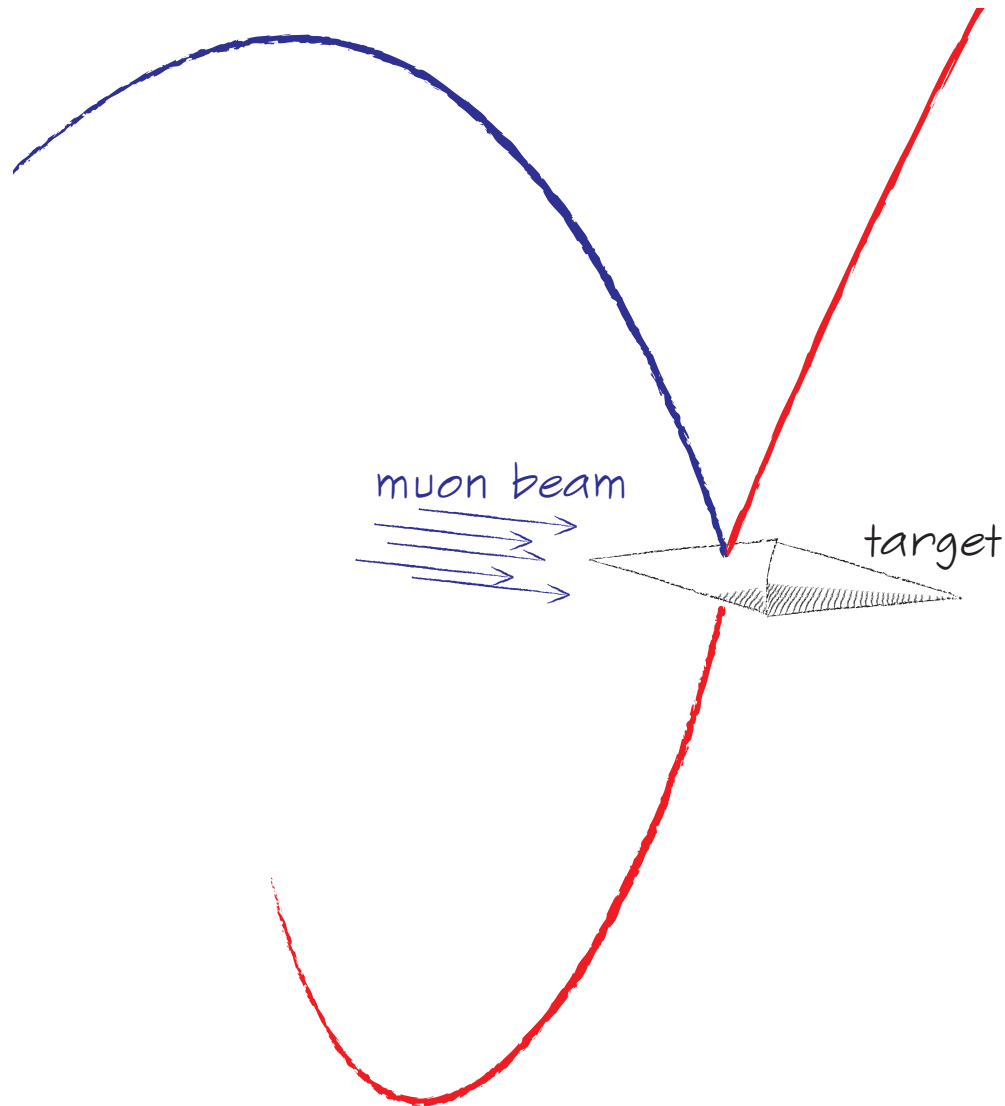

Detector Design

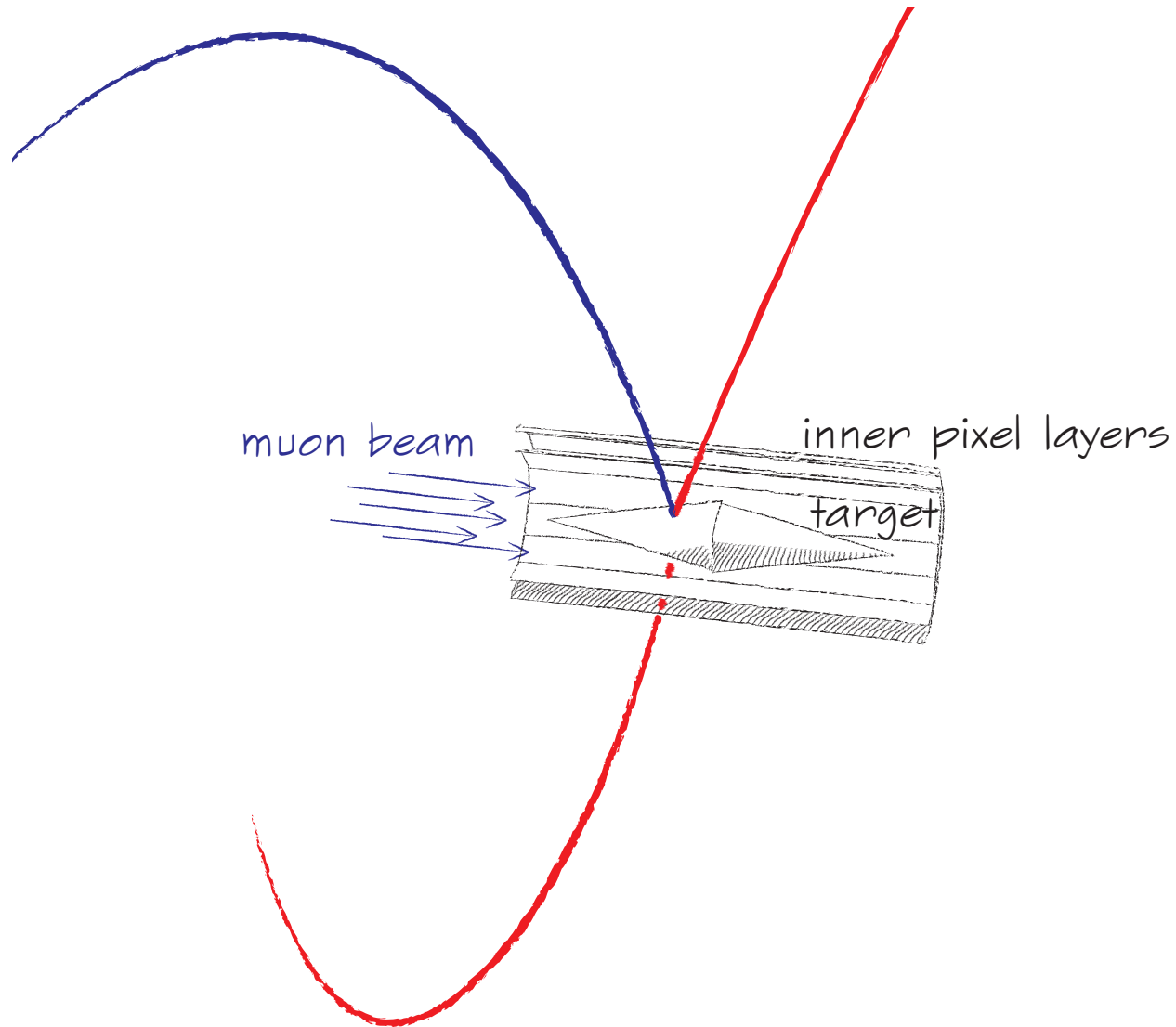

Detector Design

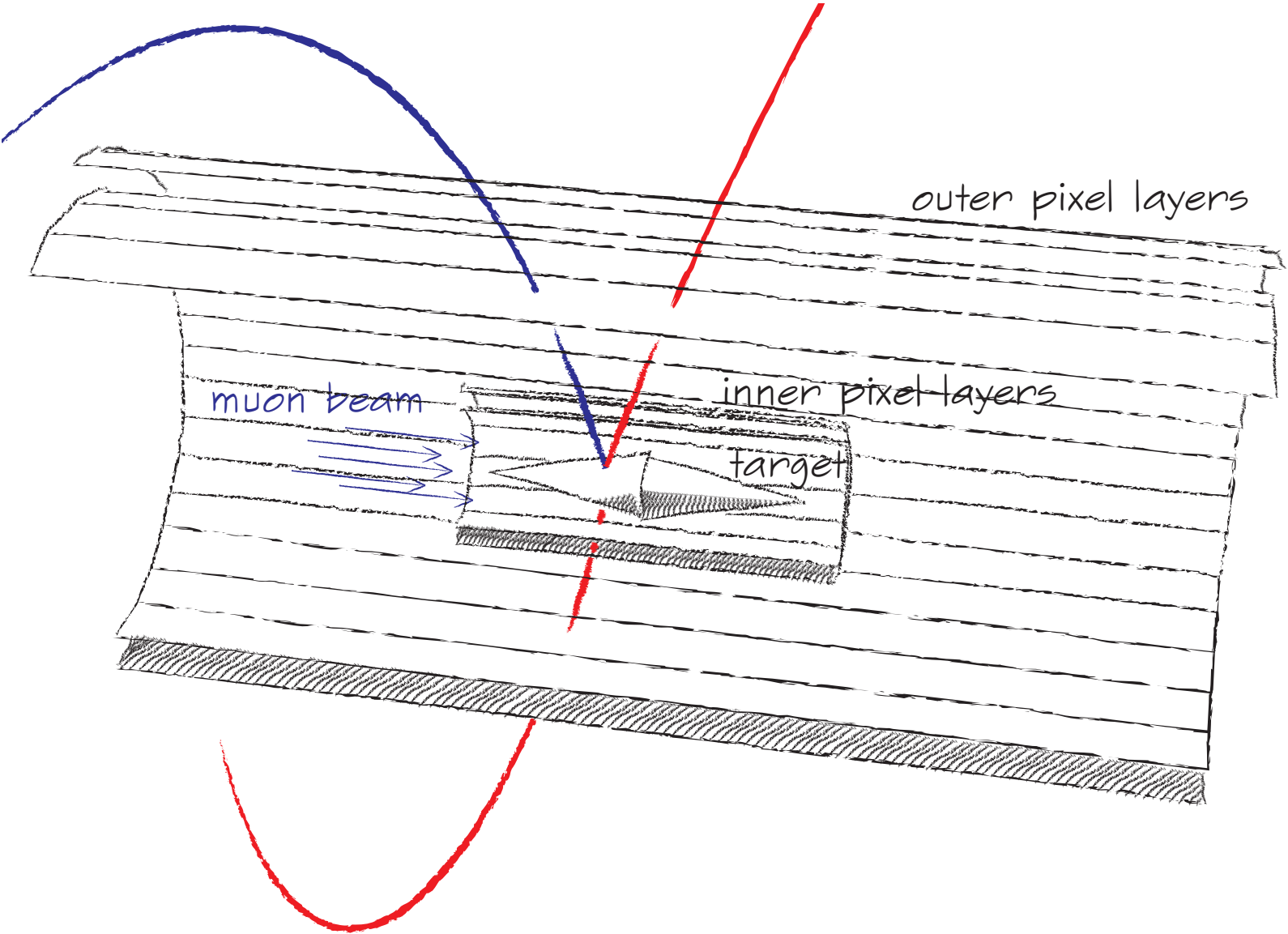

Detector Design

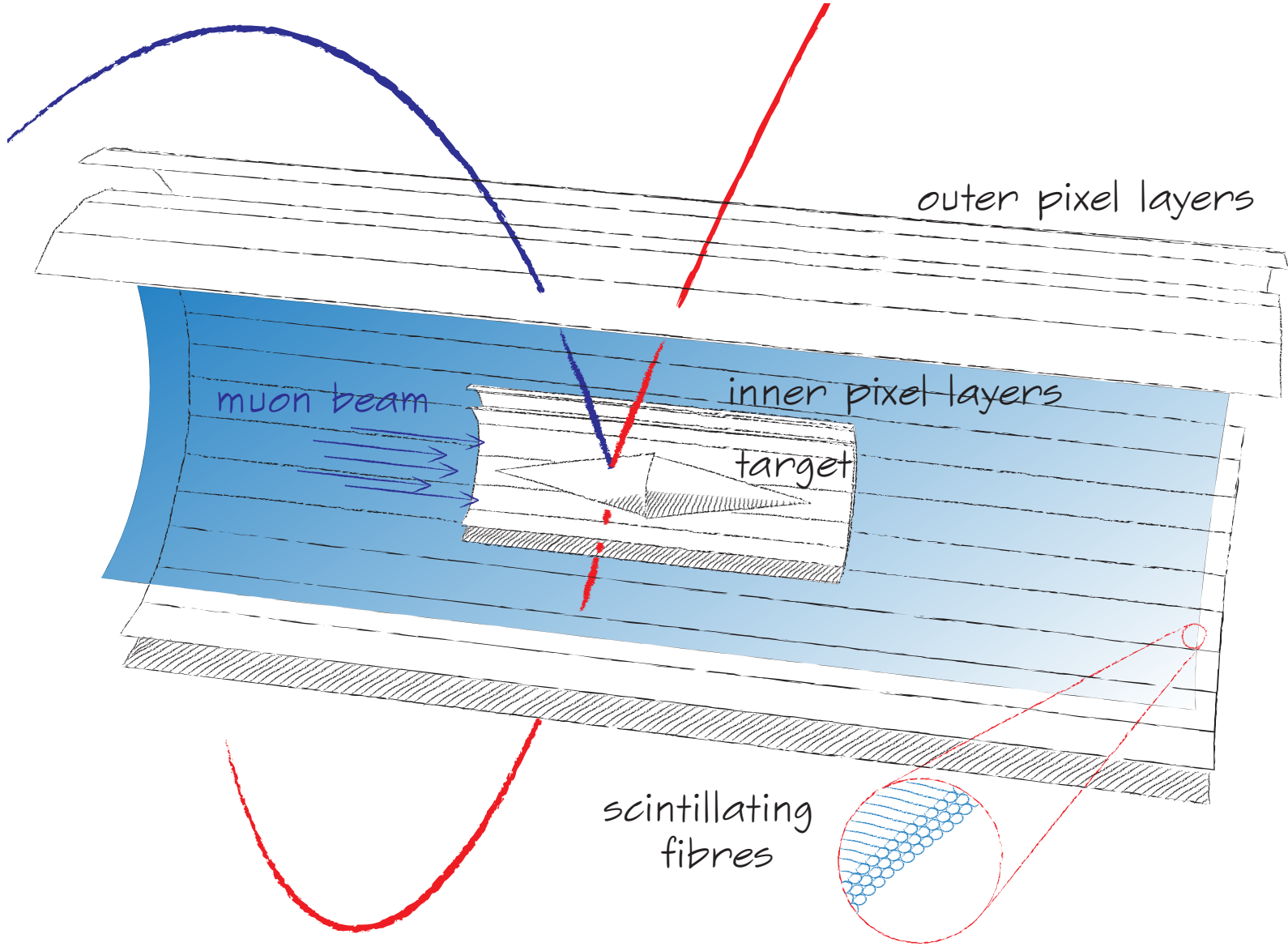

Detector Design

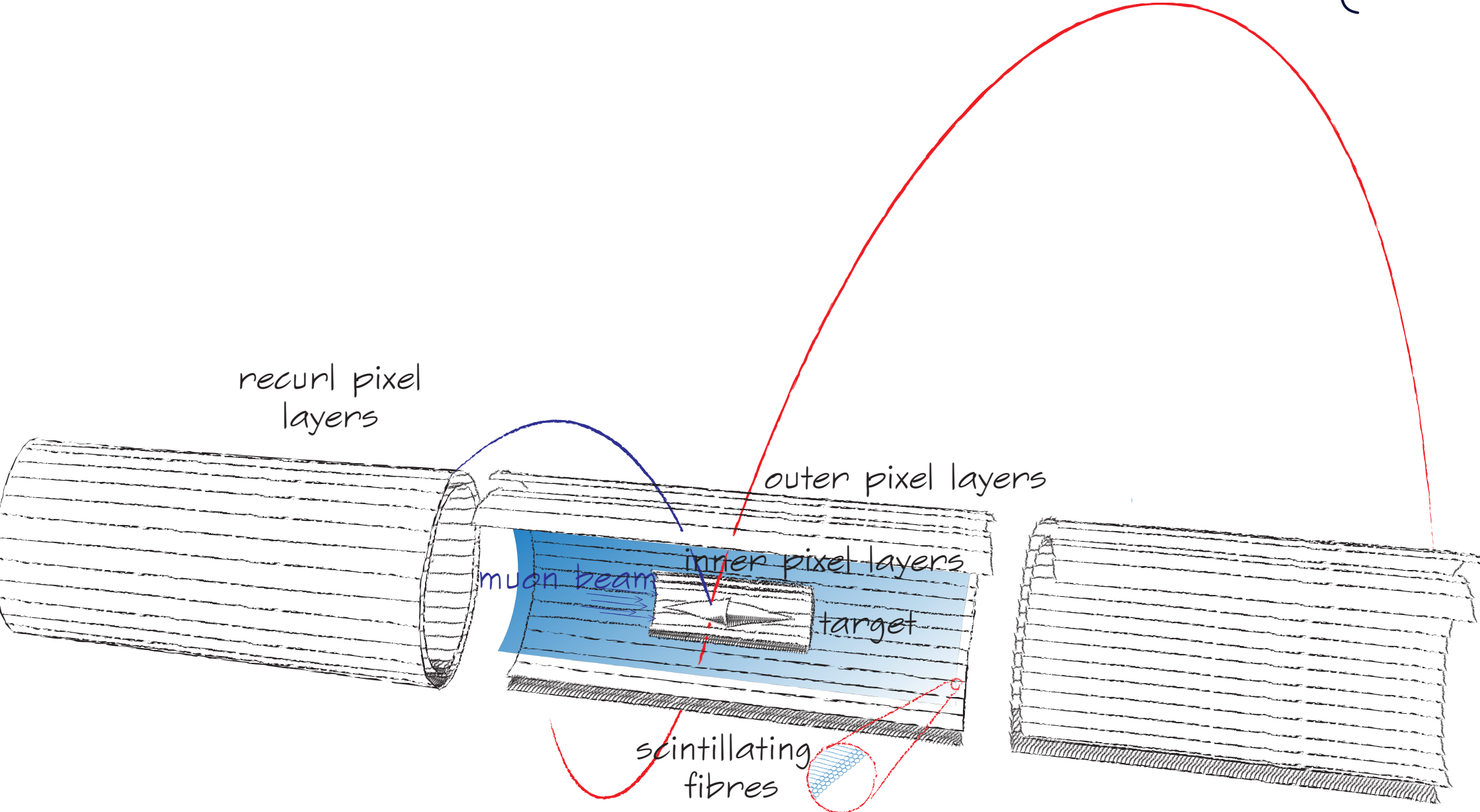

Detector Design

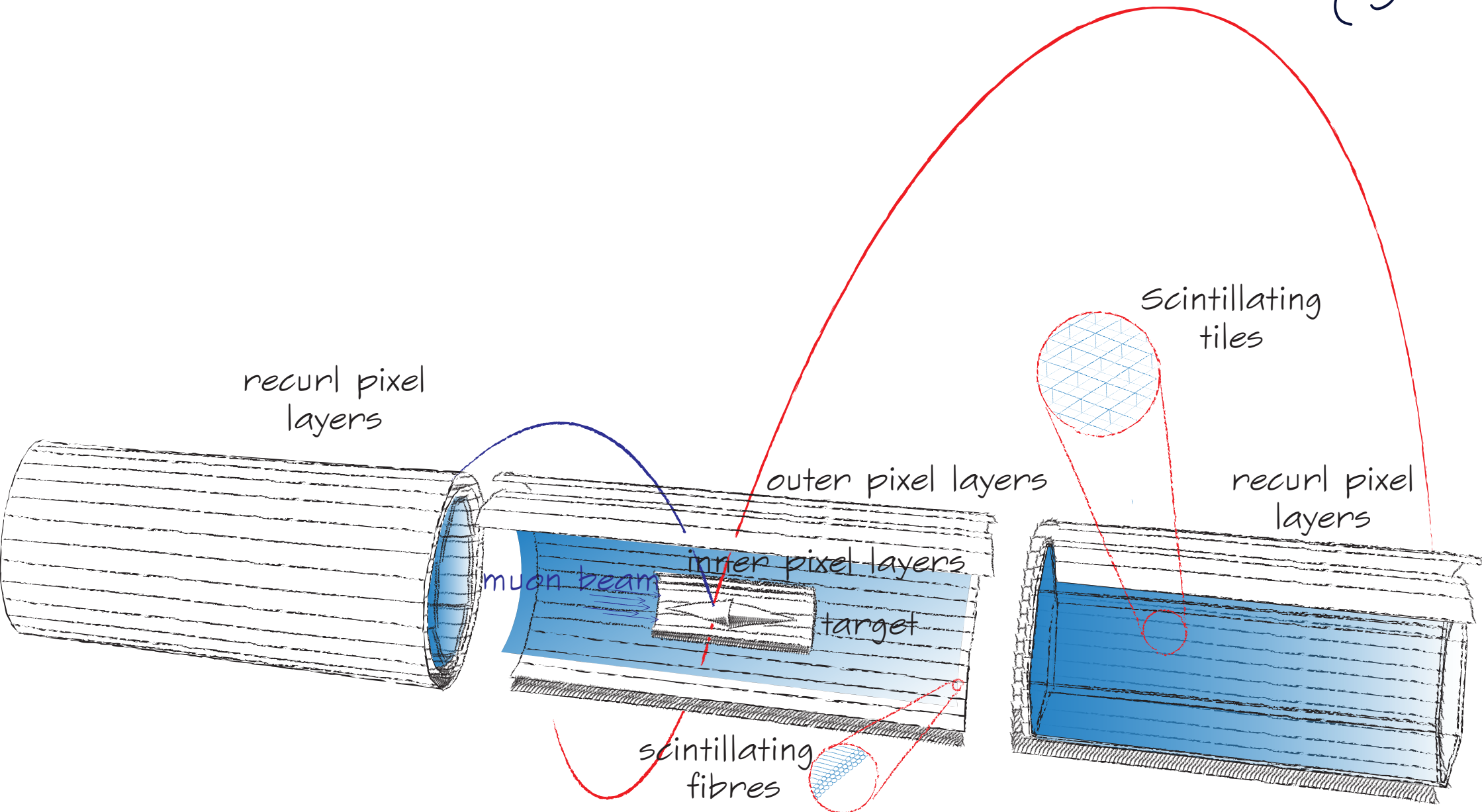

Detector Design



recurd pixel layers

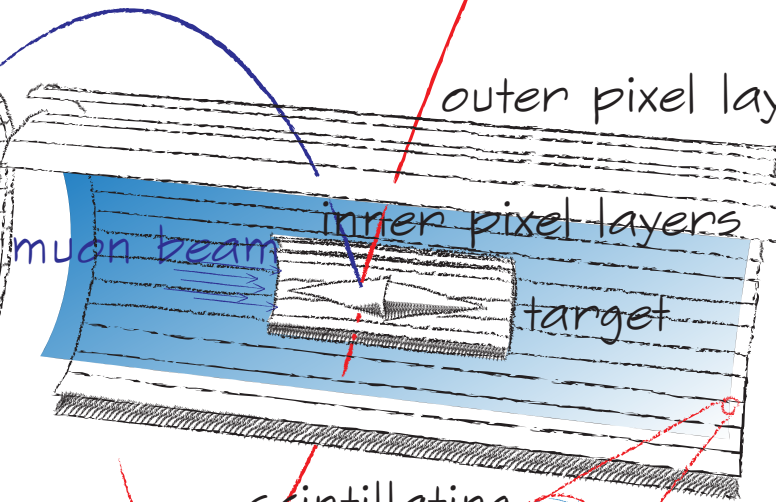

outer pixel layers

inner pixel layers

target

muon beam

scintillating fibres

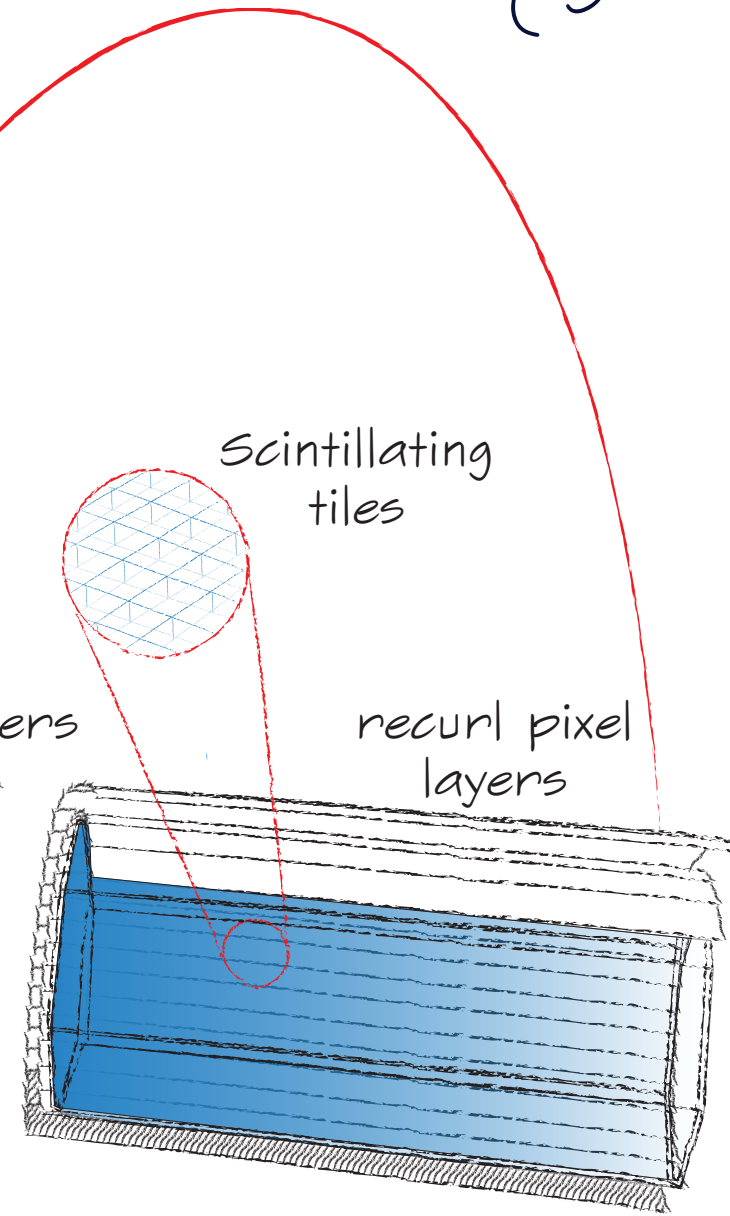
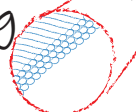

Scintillating tiles

recurd pixel layers

Detector Design



Challenges:

- Thin detectors
- Services (and beam) inside detector
- Cooling with gaseous Helium



recurl pixel layers

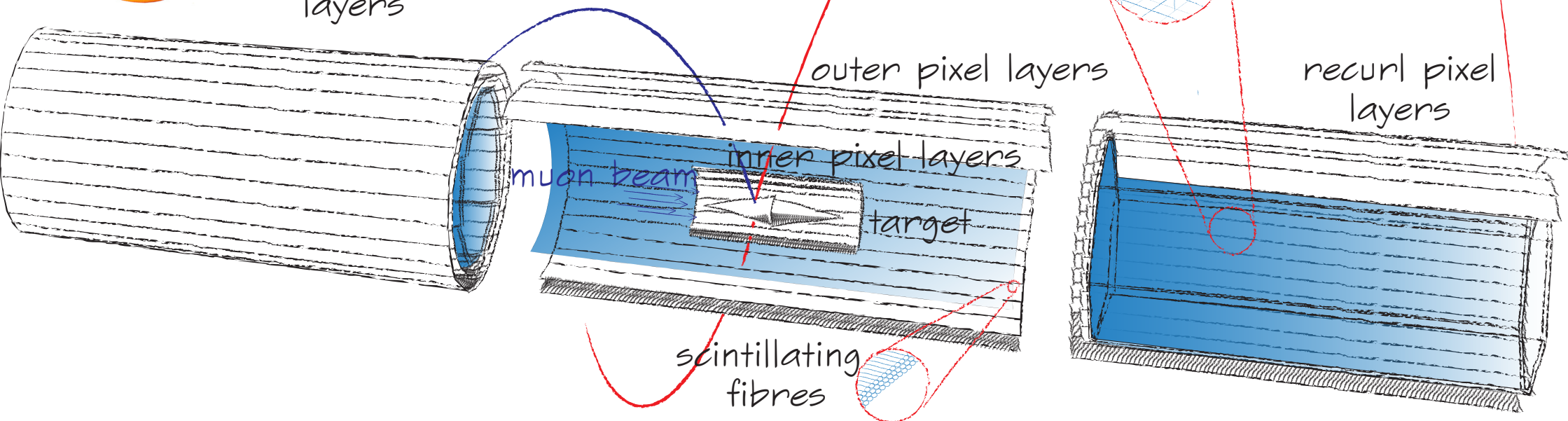

Detector Design

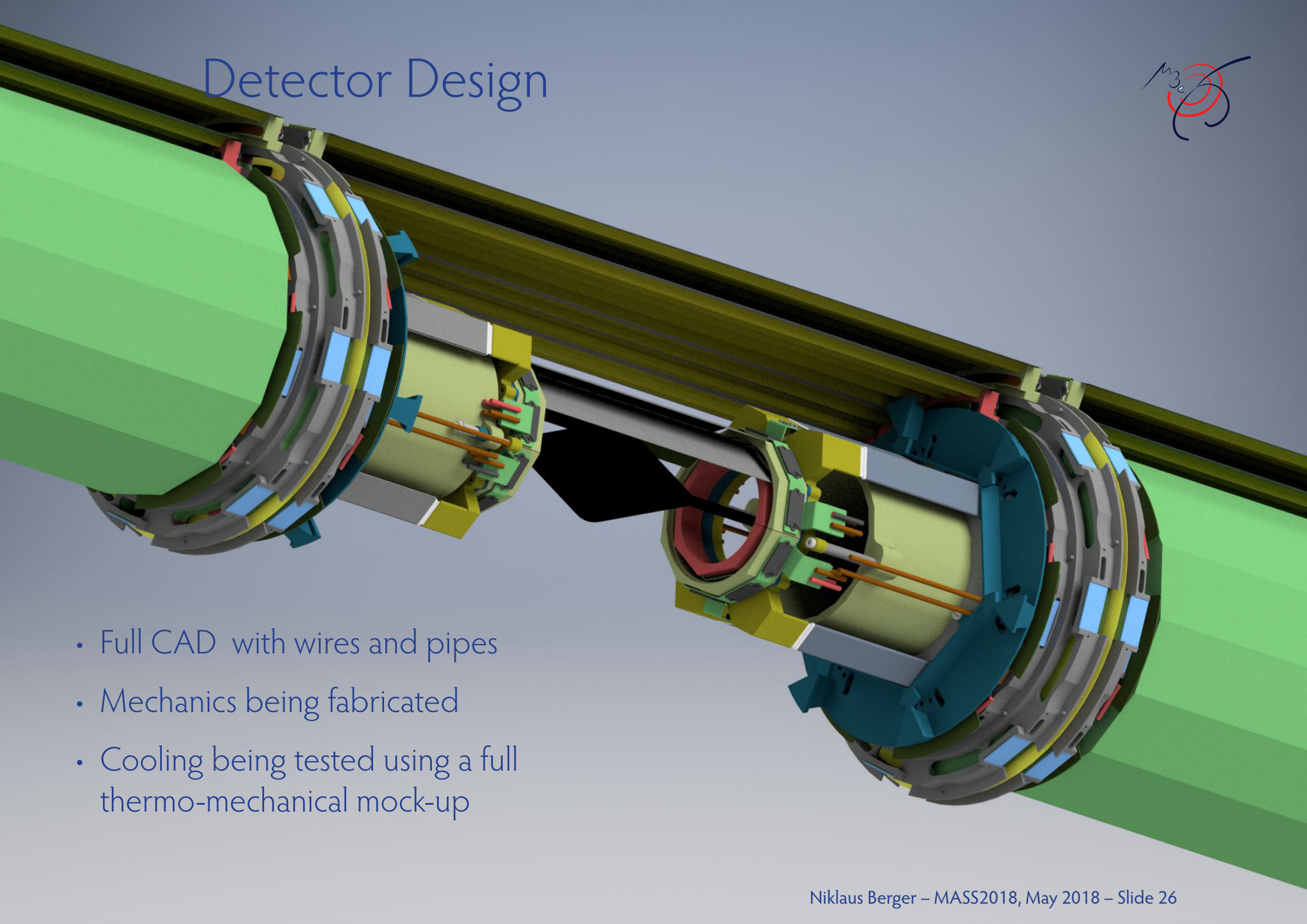

- Full CAD with wires and pipes
- Mechanics being fabricated
- Cooling being tested using a full thermo-mechanical mock-up



Very thin and fast silicon pixel sensors: HV-MAPS

Fast and thin sensors: HV-MAPS



High voltage monolithic active pixel sensors - Ivan Perić

- Use a high voltage commercial process (automotive industry)

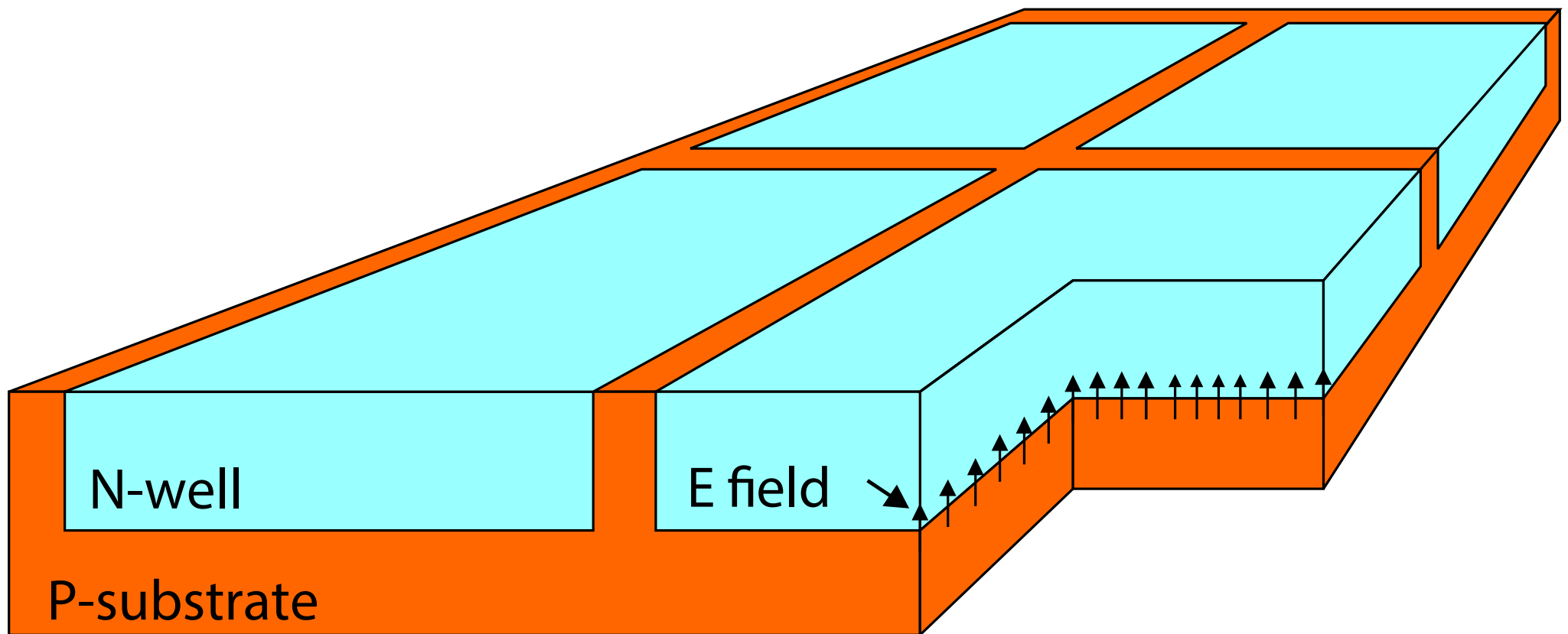

Fast and thin sensors: HV-MAPS



High voltage monolithic active pixel sensors - Ivan Perić

- Use a high voltage commercial process (automotive industry)
- Small active region, fast charge collection via drift

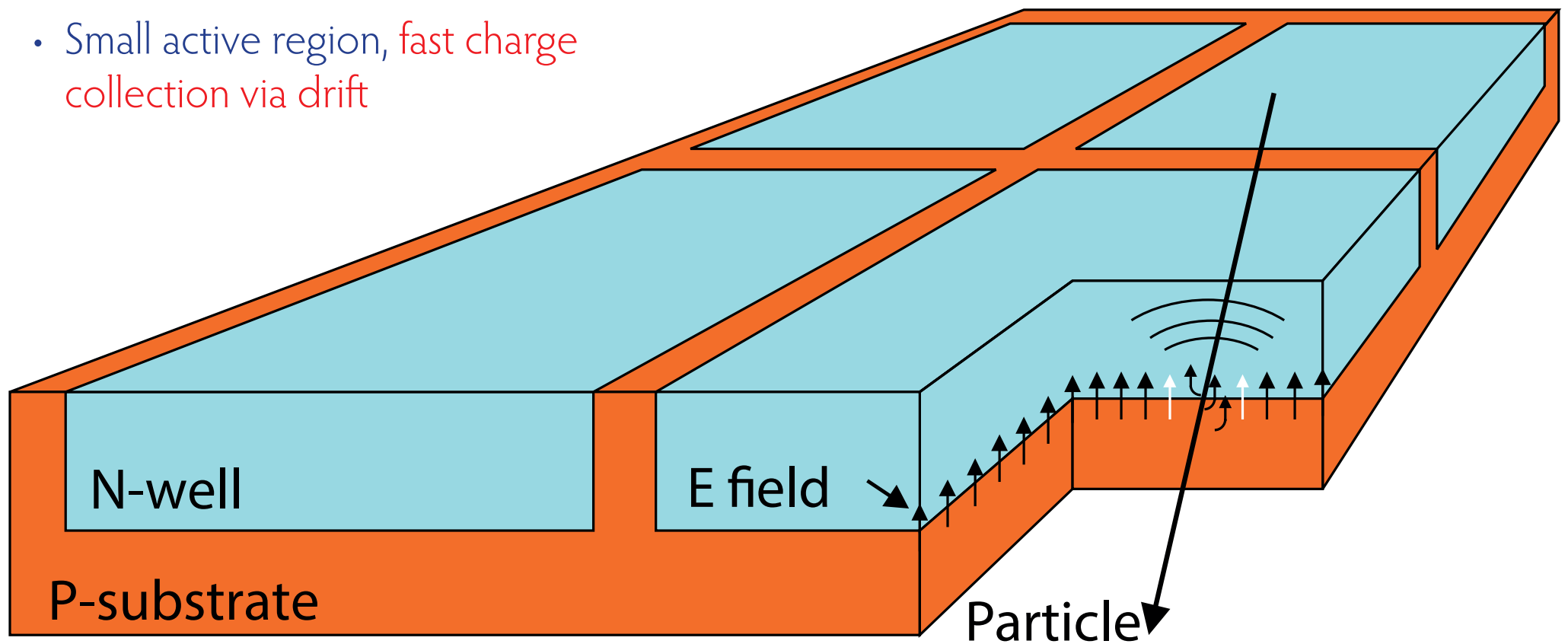

Fast and thin sensors: HV-MAPS



High voltage monolithic active pixel sensors - Ivan Perić

- Implement logic directly in N-well in the pixel - smart diode array
- Can be thinned down to $< 50 \mu\text{m}$

(I.Perić, NIM A 582 (2007) 876)

- Use a high voltage commercial process (automotive industry)
- Small active region, fast charge collection via drift

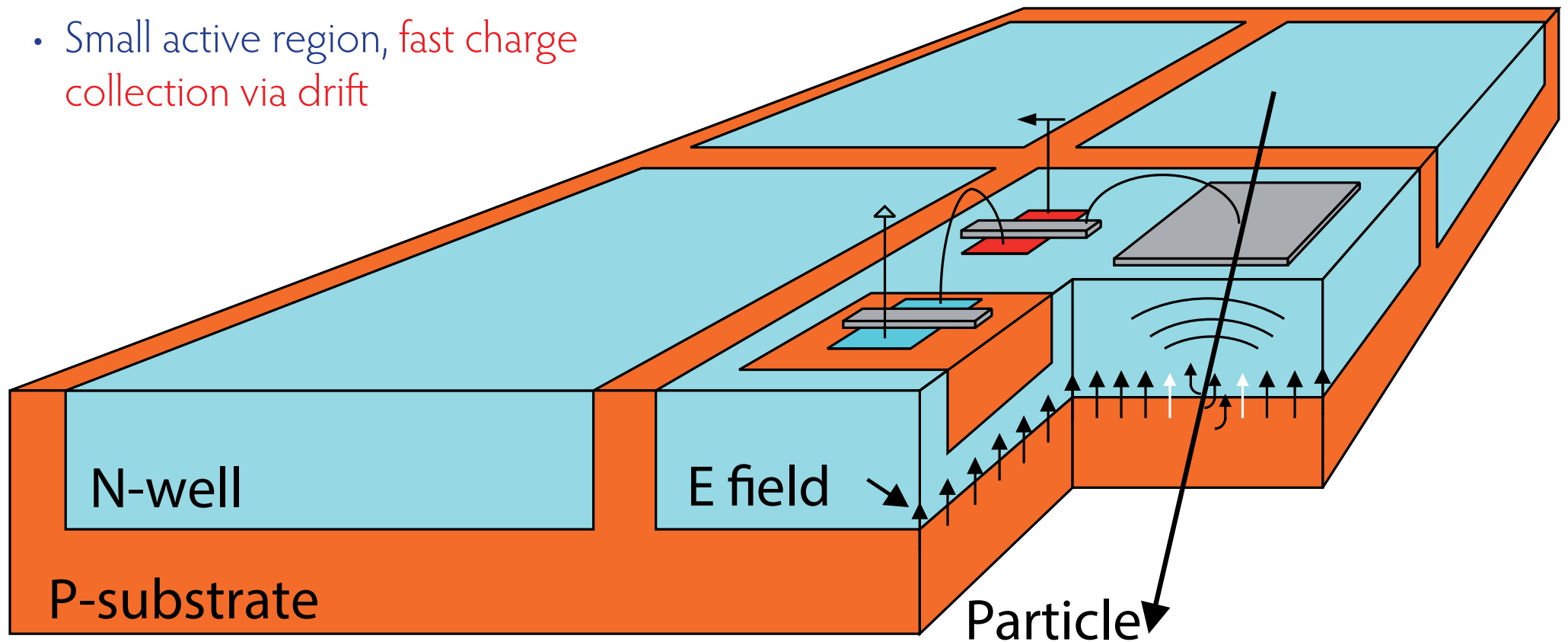

The MuPix Prototypes

Developed a series of HV-MAPS prototypes

- Goal: Detection and signal processing with just 50 μm silicon
- 6th chip, MuPix7, was the first **full system-on-a-chip**
- **Going "big"** 2 x 1 cm^2 MuPix8 with 80 by 80 μm pixels also working nicely - some growing pains fixed
- Now: **MuPix10, 2 x 2 cm^2** , integration ready - under test

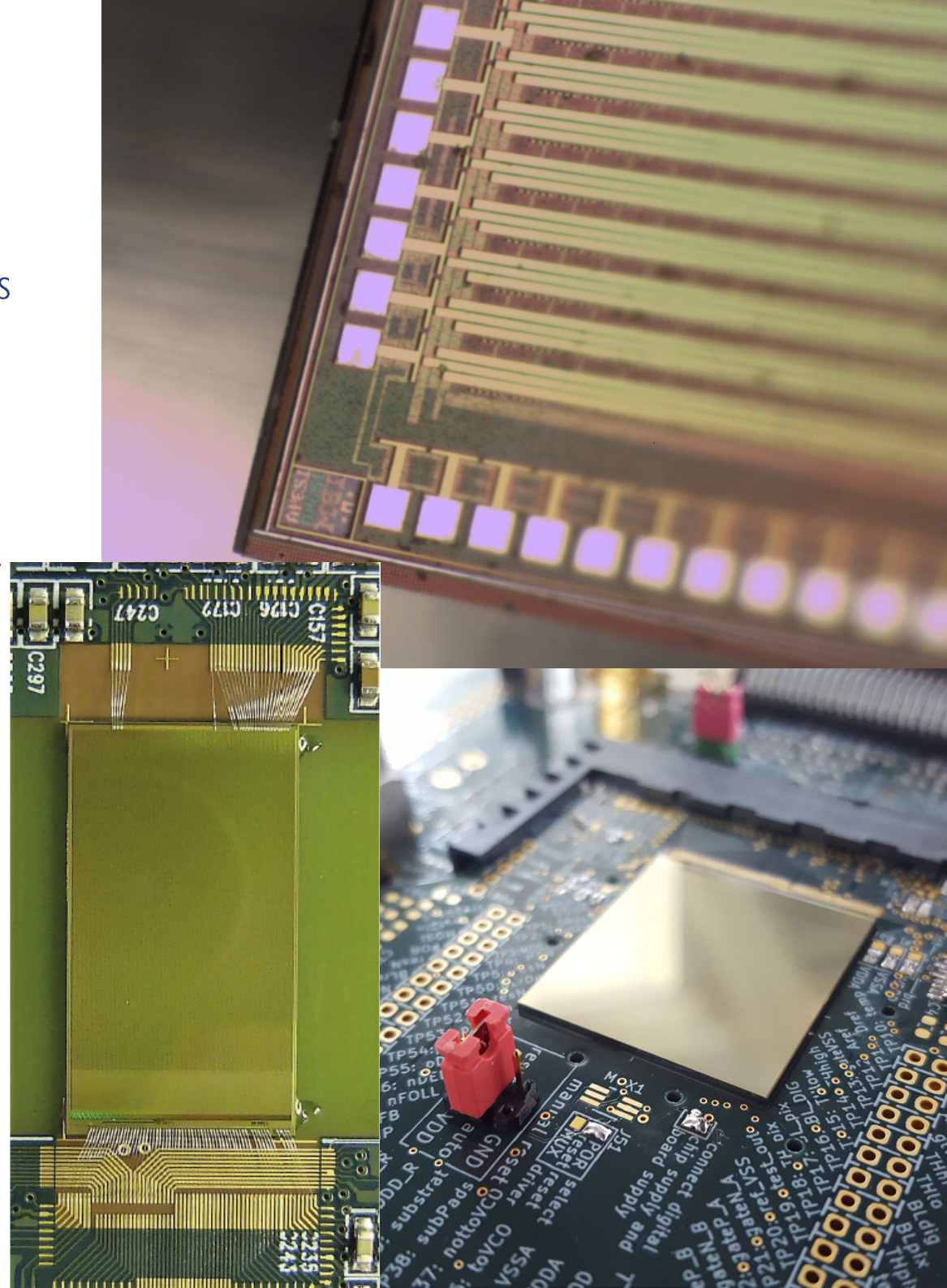

MuPix8: Results



efficiency
~99.9%

noise
~1Hz/pixel

Time resolution of $< 6 \text{ ns } \sigma$ reached

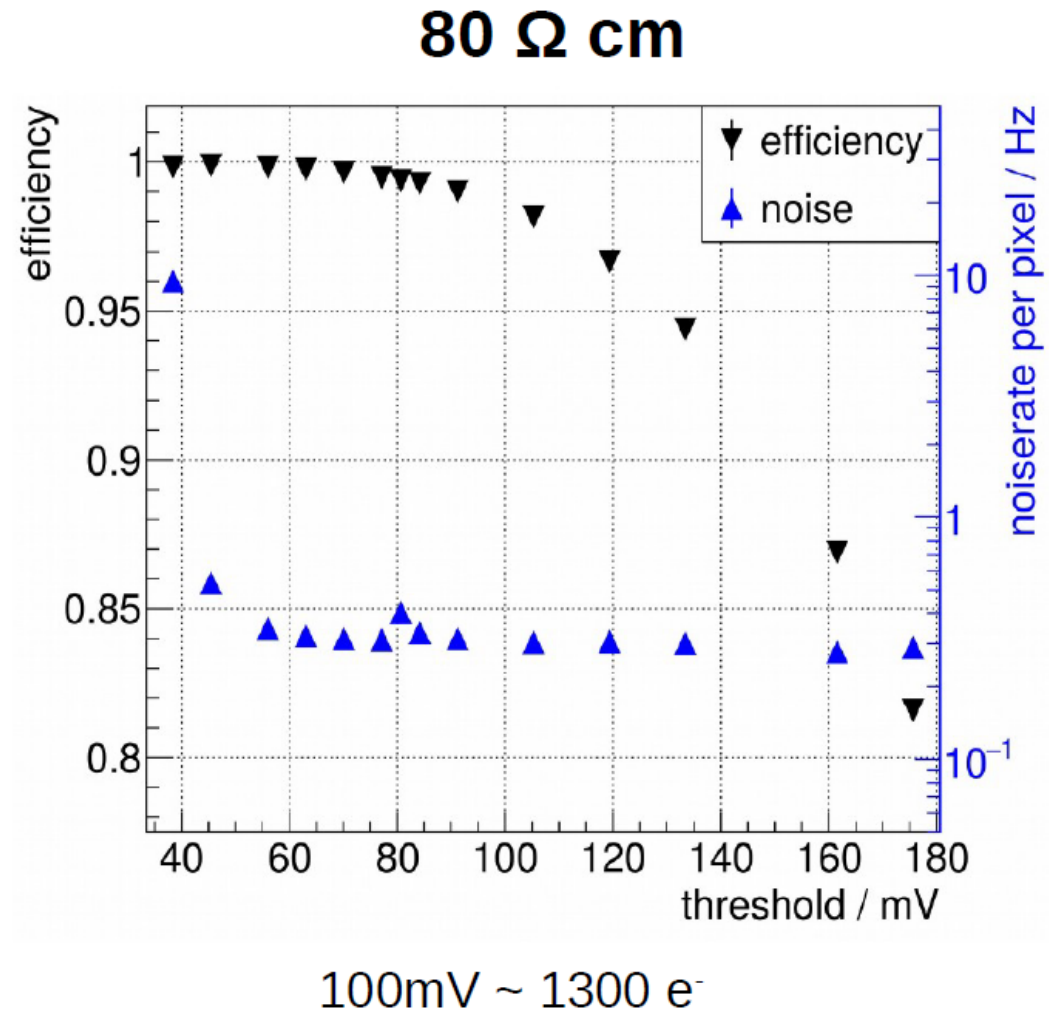
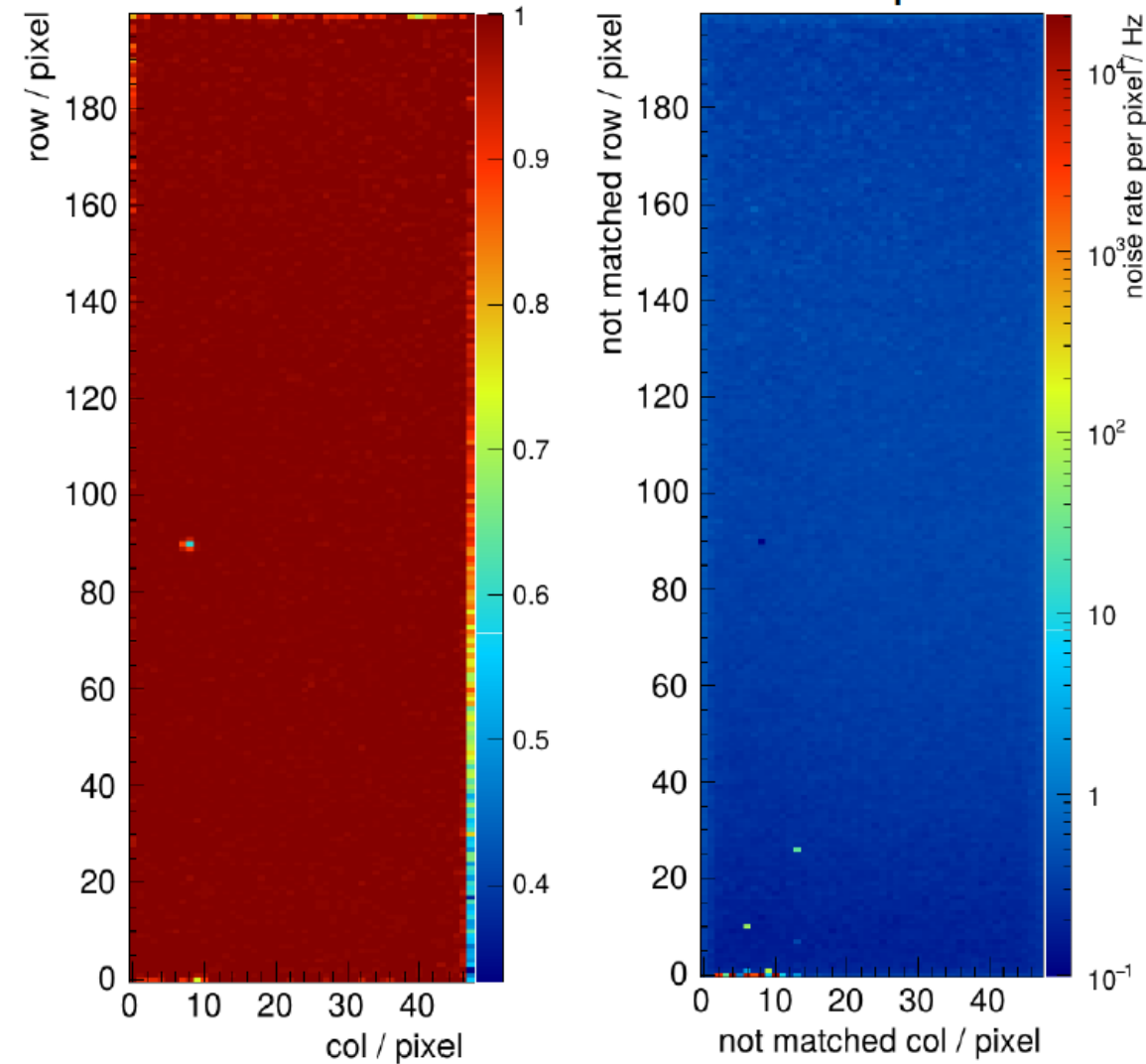

Integration with Flexprint

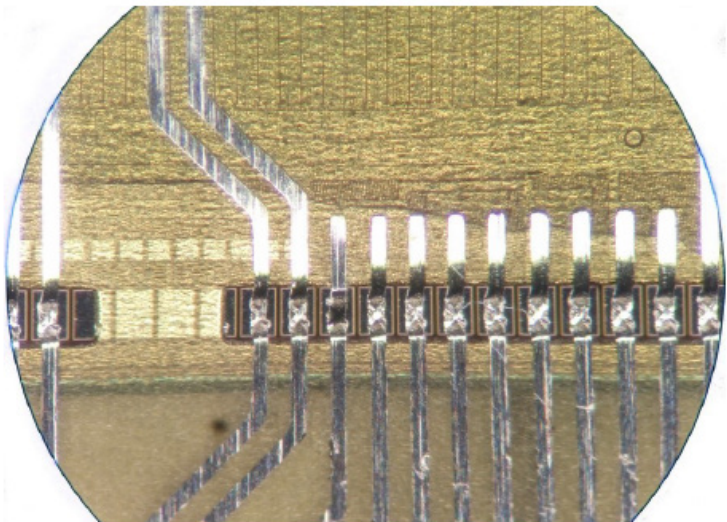
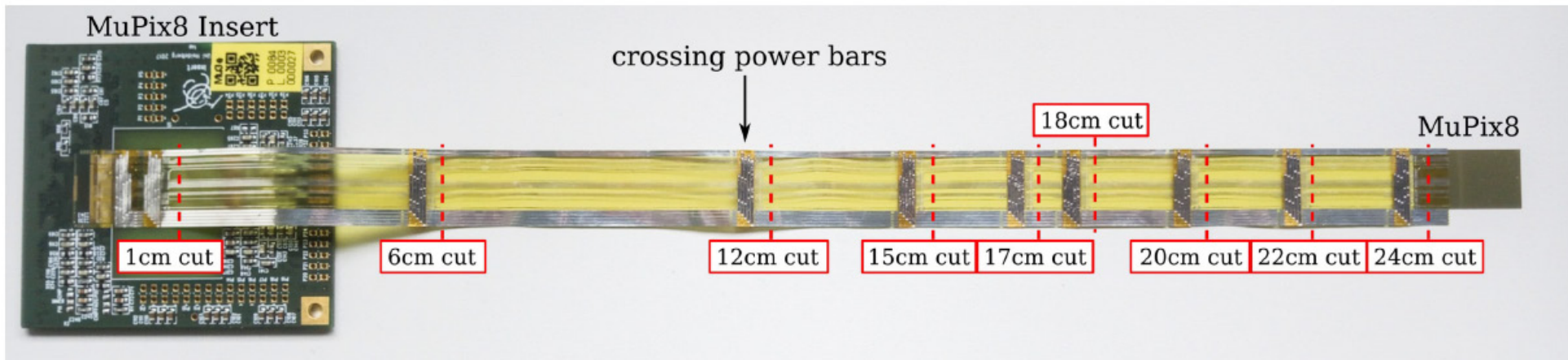

Operate MuPix on an aluminium-kapton flexprint without decoupling capacitors

- Low noise
- No transmission errors
- Longer than needed for Mu3e





Better timing: Scintillating fibres and tiles

Timing Detector: Scintillating Fibres



- 3 layers of 250 μm scintillating fibres
- Read-out by silicon photomultipliers (SiPMs) and custom ASIC (MuTRiG)

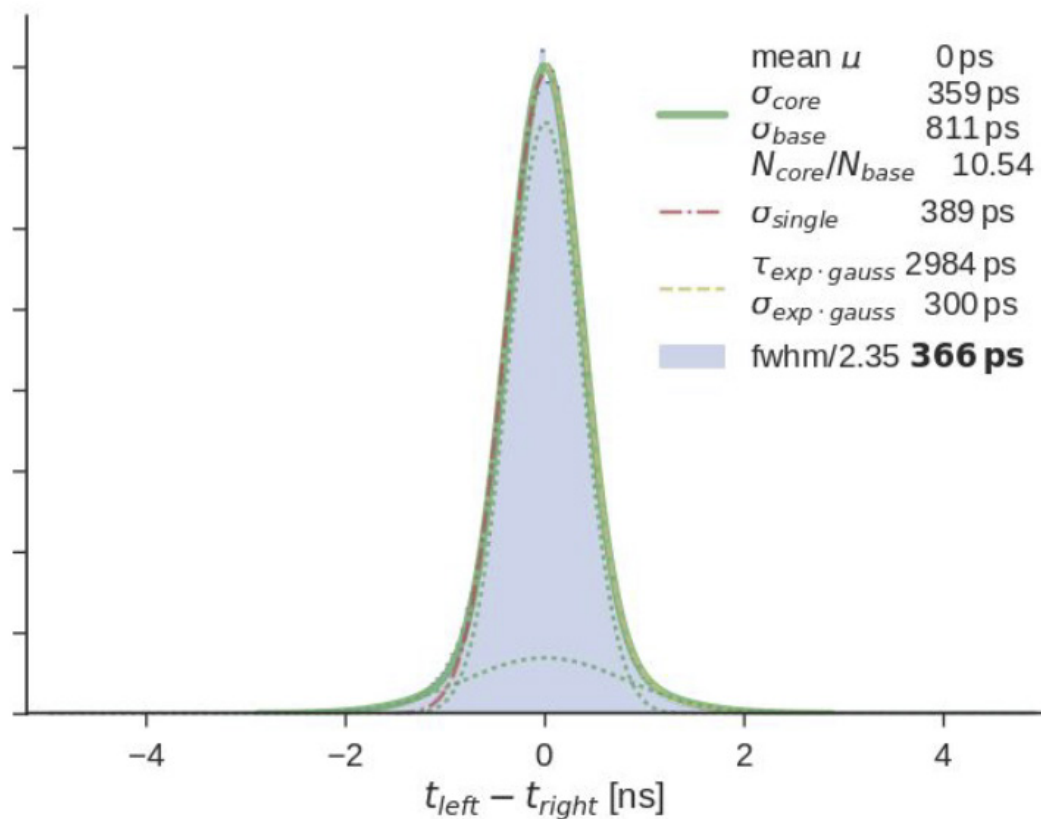
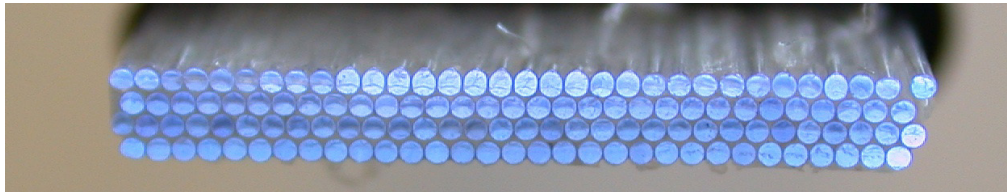

Timing resolution < 400 ps including ASIC

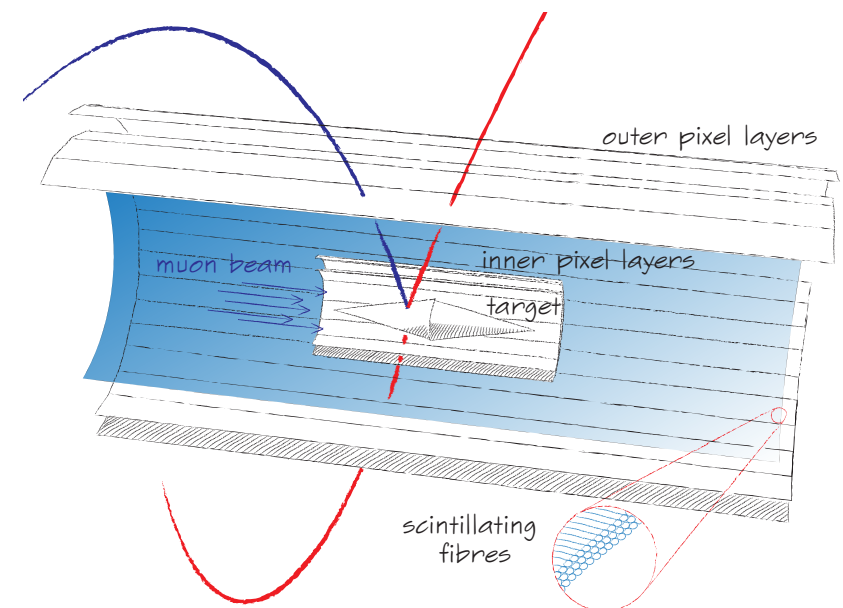

Timing Detector: Scintillating tiles

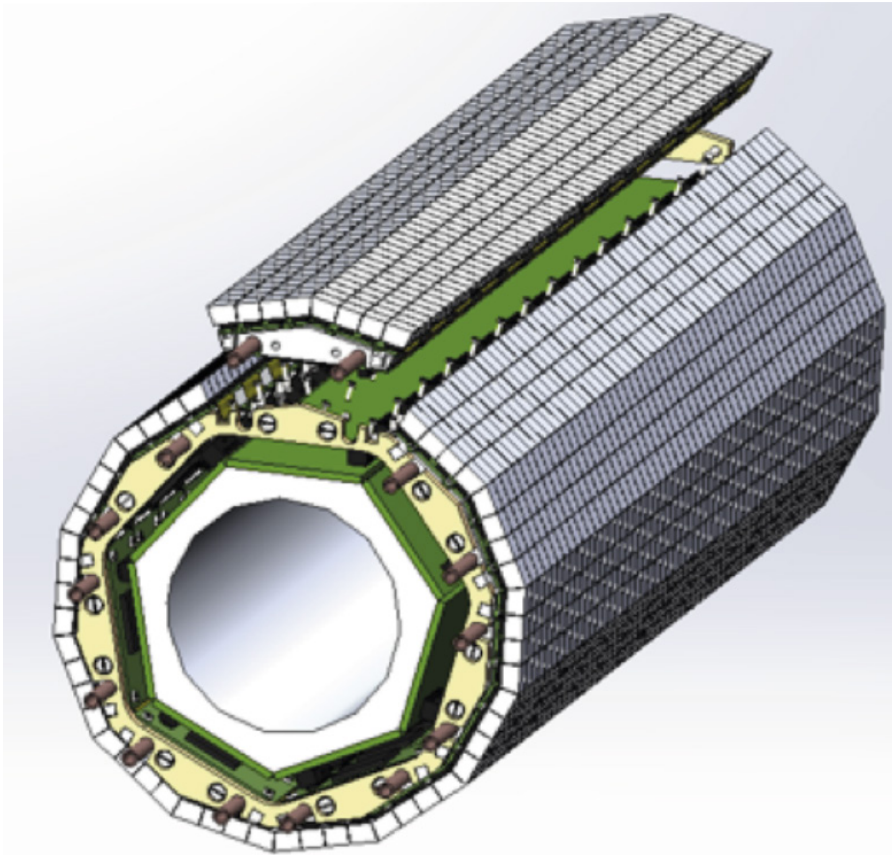

- $\sim 0.5 \text{ cm}^3$ scintillating tiles
- Read-out by silicon photomultipliers (SiPMs) and custom ASIC (MuTRiG)

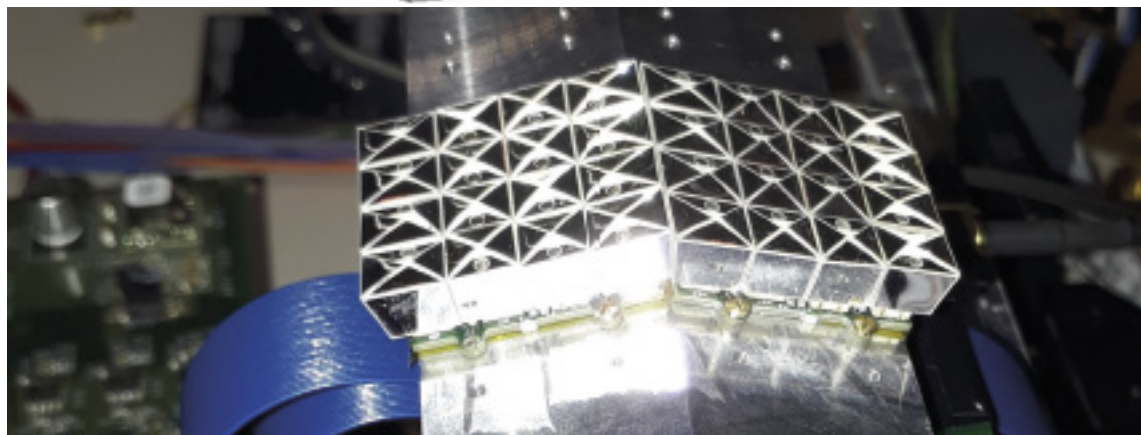
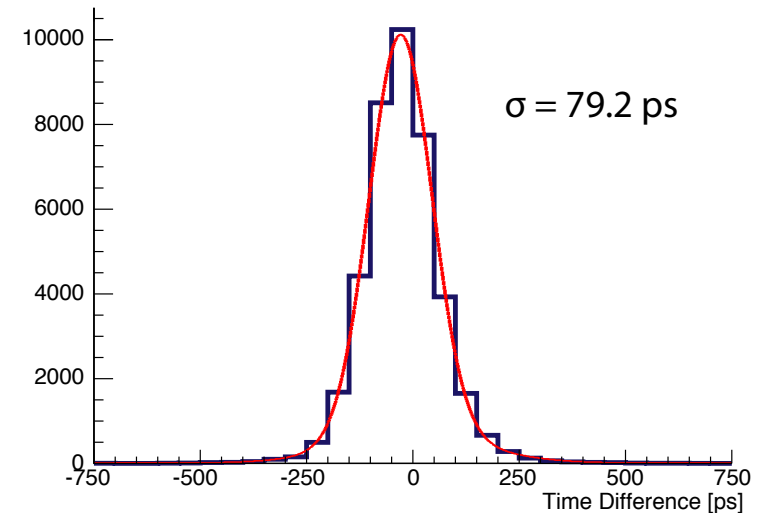

- Test beam with tiles, SiPMs and readout ASIC
- Timing resolution better 80 ps



Phased experiment:

Phase I uses the existing PiE5 beam line at PSI, shared with MEG II, 10^8 muons/s

Phase II requires a High Intensity Muon Beamline (HiMB, $> 2 \cdot 10^9$ muons/s)



Mu3e Phase I Simulation

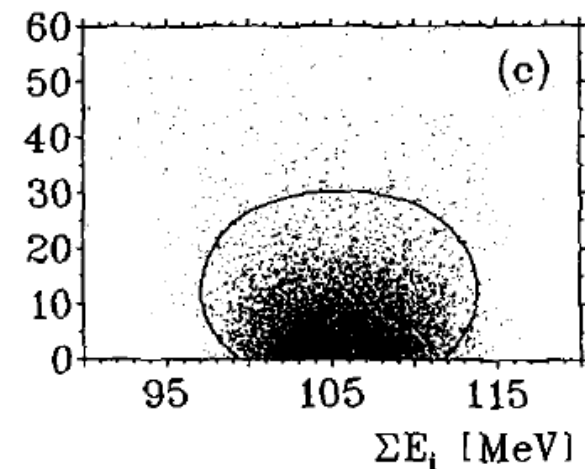
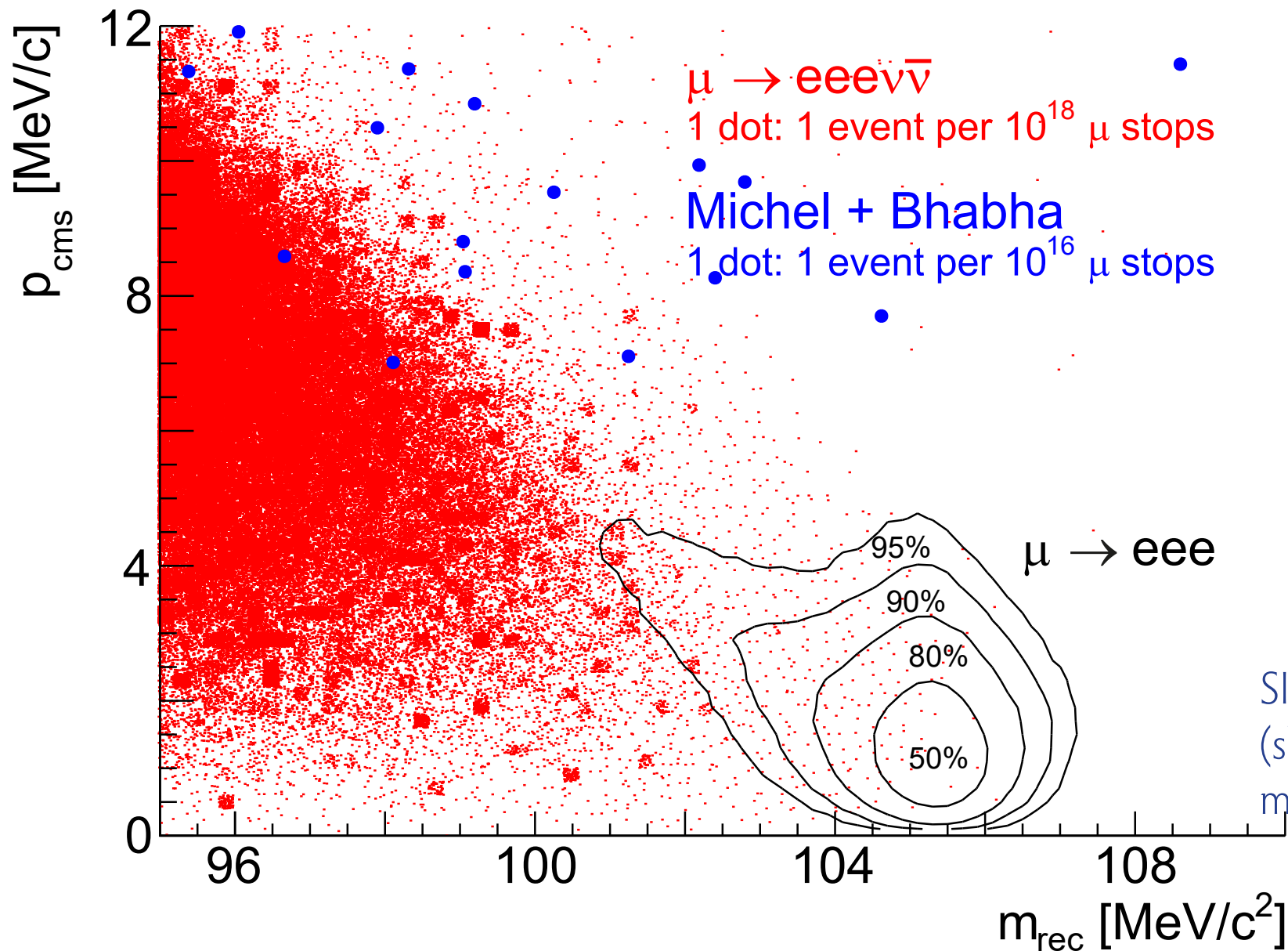

SINDRUM simulation
(slightly different
momentum variable)

Sensitivity - Mu3e Phase I

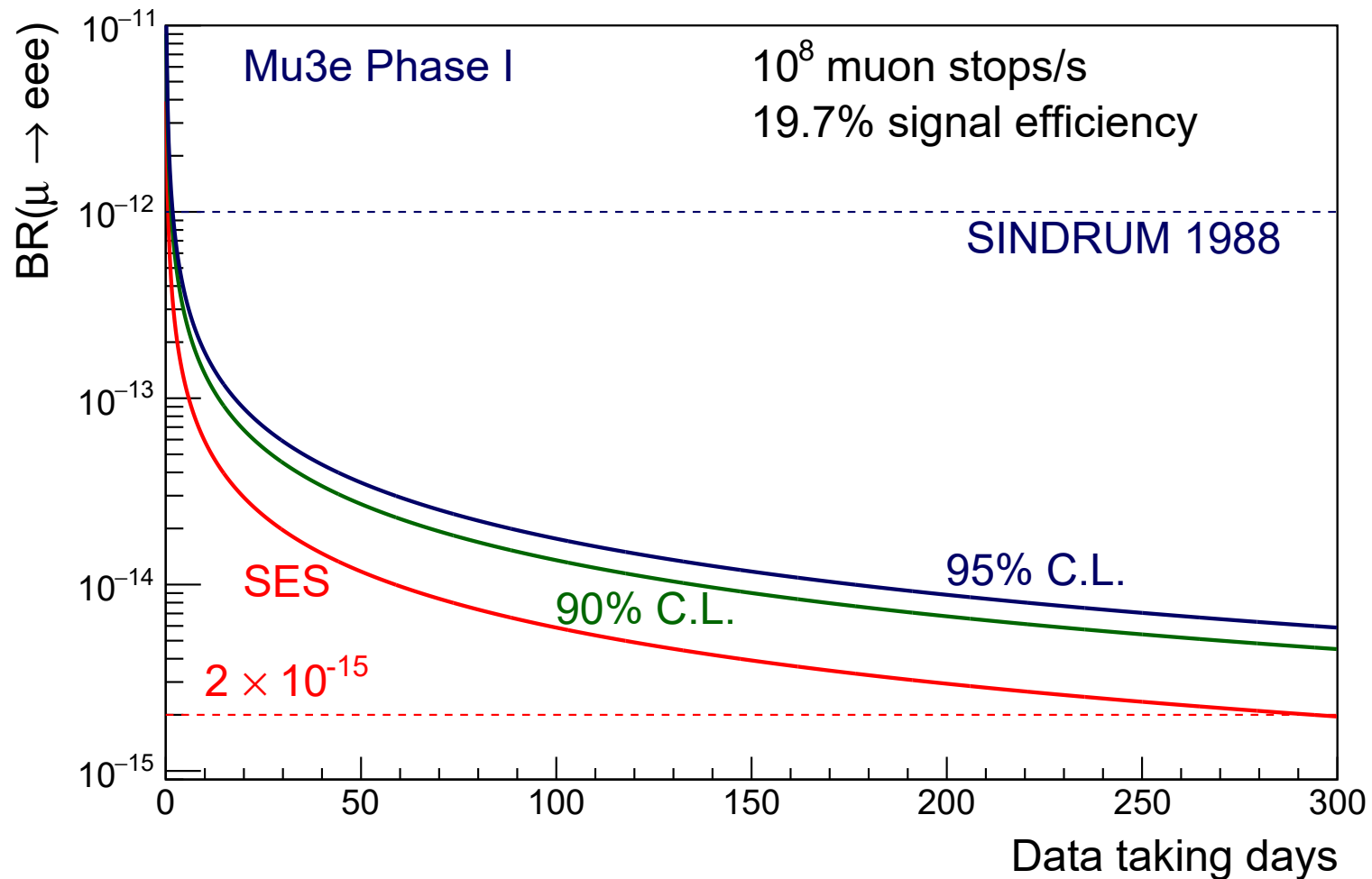

- Magnet arrives at PSI in autumn, integration tests
- Construction in 2021
- Data taking 2022++



Mu3e Phase II

Mu3e Phase II - High Intensity Muon Beamline

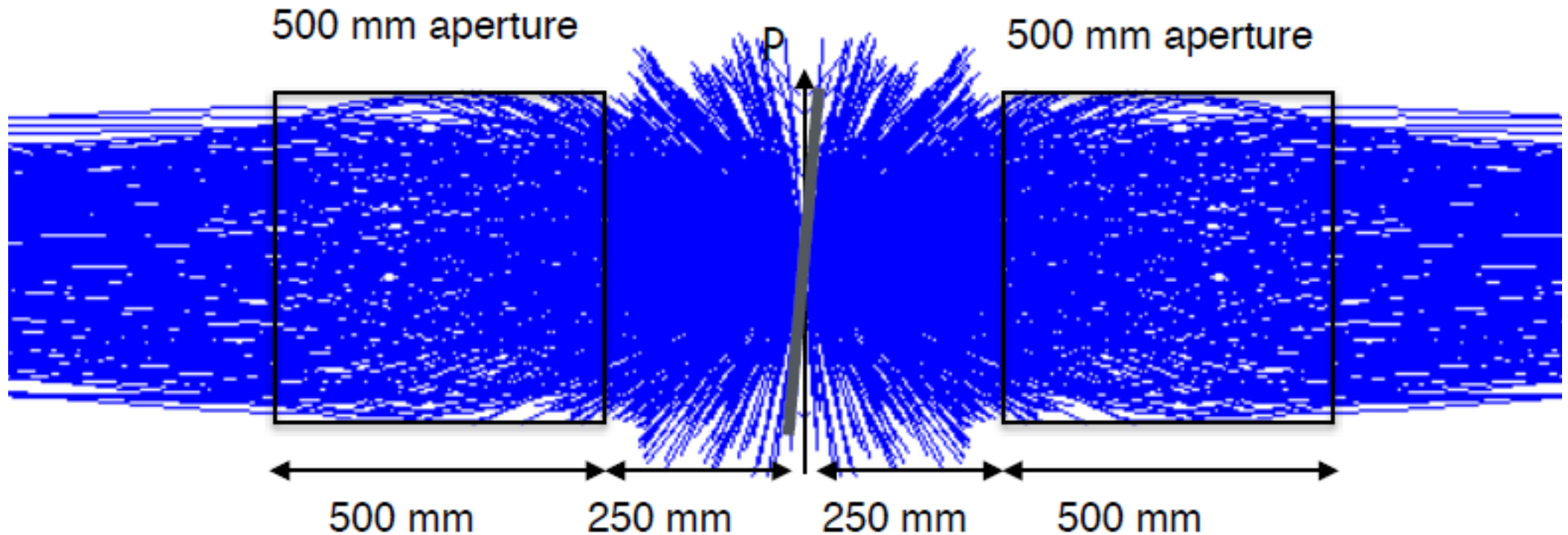

- Ongoing study at PSI
- Same proton accelerator, keep E target (MEG/Mu3e I) and spallation neutron source
- Replace M target (MUSE)
- Optimized target geometry (successfully tested in 2019)
- Solenoidal capture, one channel for particle physics one for μ SR (solid state)
- $> 10^{10}$ surface muons/s

Detector improvements



- Aim for 2×10^9 μ -stops/s:
 10^{-16} single event sensitivity
- Smaller target radius:
 Better vertex resolution
- Longer pixel modules:
 Better geometric acceptance
- Need to replace scintillating fibres:
 Occupancy approaching 100%,
 SiPM radiation hardness

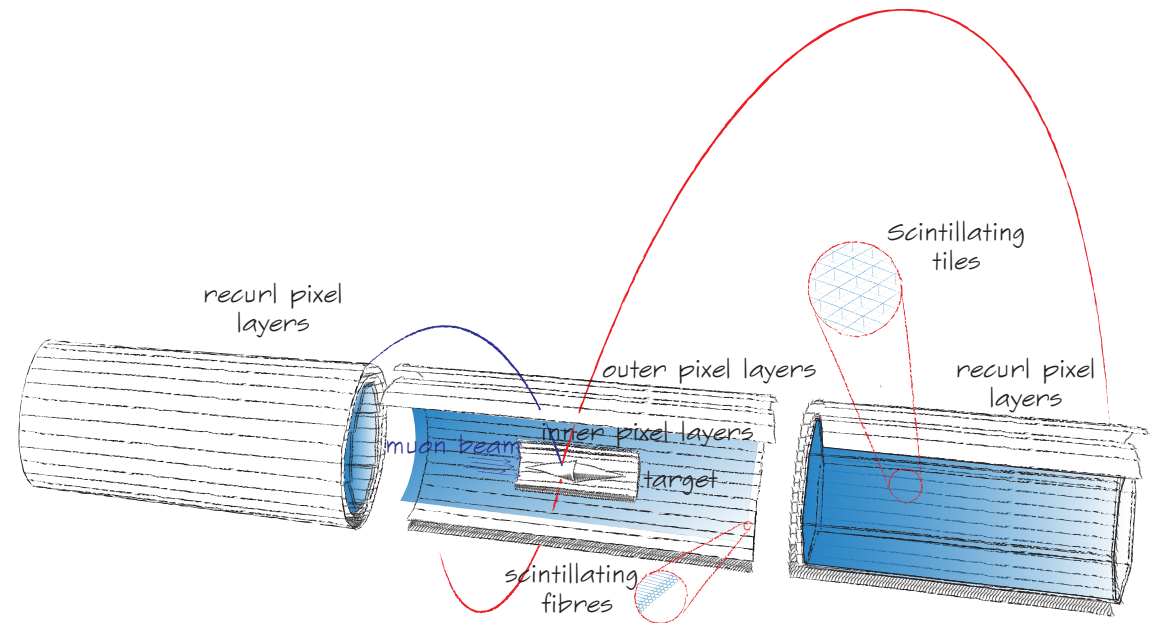

Silicon detectors with sub ns timing resolution (LGAD and derived) - how to power, how to cool - R&D started



Beyond Mu3e

Better momentum resolution!



- Resolution dominated by **multiple scattering**
- Momentum resolution to first order:

$$\sigma_{P/P} \sim \theta_{MS}/\Omega$$

- Precision requires large lever arm (**large bending angle Ω**) and **low multiple scattering θ_{MS}**

- Geometry close to optimal
- **Thinner layers:** Now at $\sim 1.1\% X_0$

Push silicon from $50 \mu\text{m} \rightarrow 35 \mu\text{m}$

Reduce interconnect thickness by chip-to-chip connections (wafer postprocessing)

$0.7\% X_0$ maybe possible,
not very much gain ($\theta_{MS} \sim \sqrt{X/X_0}$)

- Think different, go to high-energy decay in-flight (NA-62 like)
Very, very long decay tube...

Better timing resolution!



- Push timing resolution of silicon pixels

Keep power/cooling and material budget in mind

- Absolutely needed for reconstruction:
Combinatorics, confusion, fakes
- Better scintillator time resolution only helps if tracker is also better (matching problem)

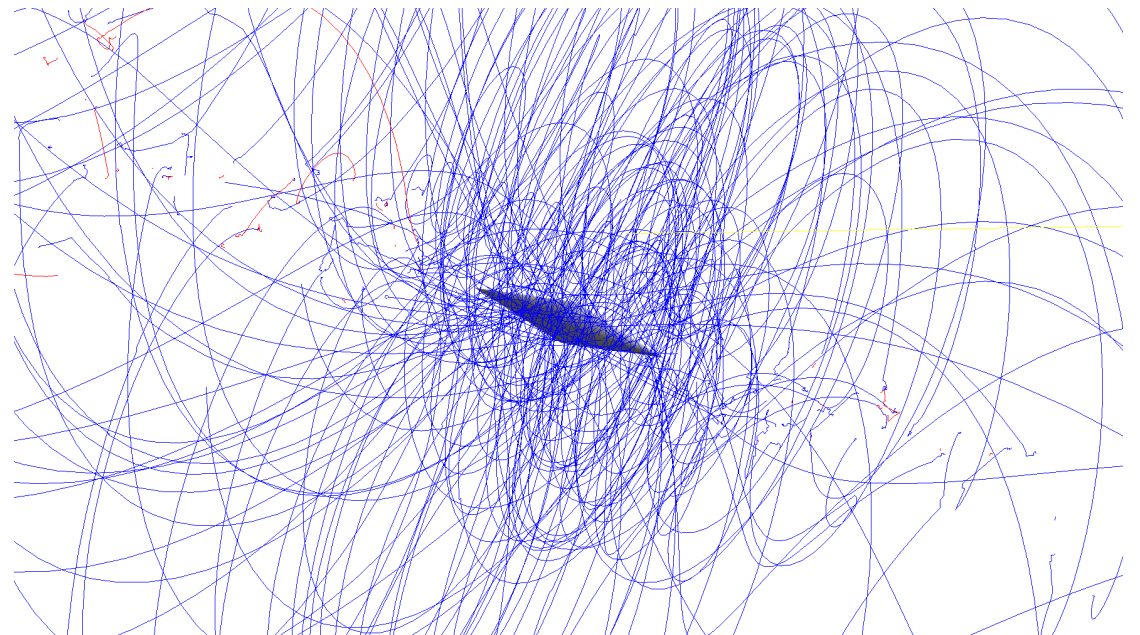

Better vertex separation!



- Smaller pixels in innermost layer
(this is the only place where this helps)
- Smaller radius of innermost layer
(less extrapolation)
- Longer target
(more spread, less material in
transverse direction,
but beam divergence...)

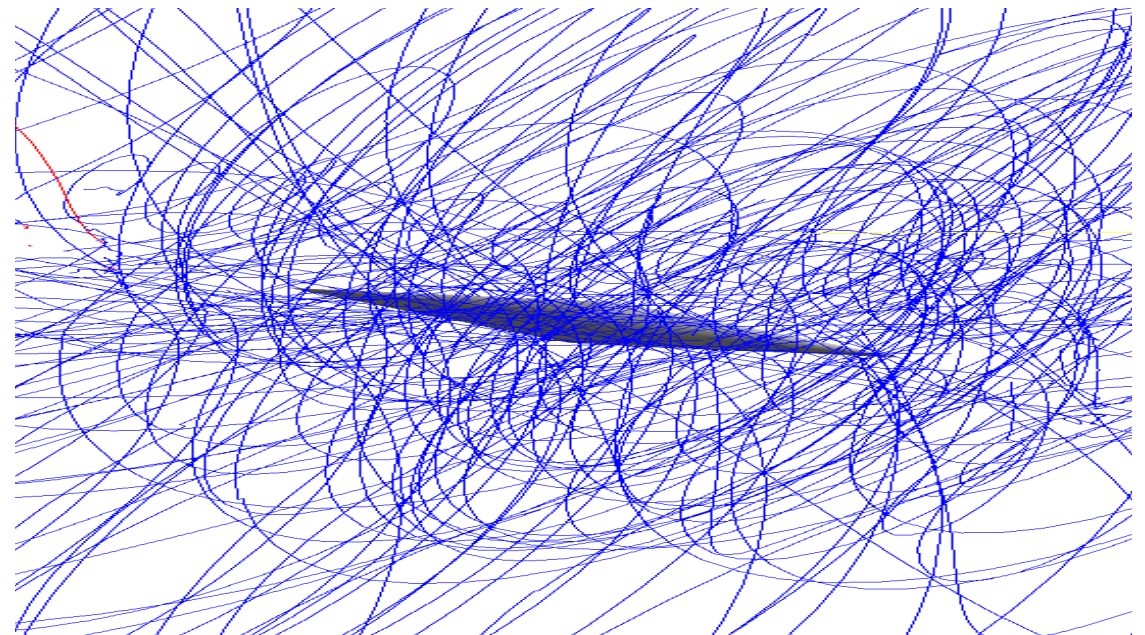

Summary



- SINDRUM:
Still best limit: $BR < 10^{-12}$
- Mu3e Phase I:
Search for $\mu \rightarrow eee$ with a sensitivity of $2 \cdot 10^{-15}$ - starting to put detector together
- Mu3e Phase II:
Challenging path to 10^{-16} - technologies existing
- Beyond 10^{-16} :
Will need new technologies, new ideas

LFV Muon Decays

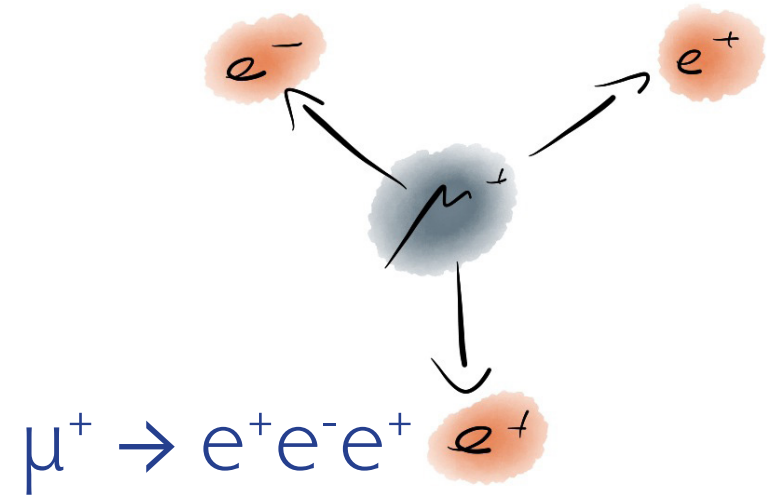
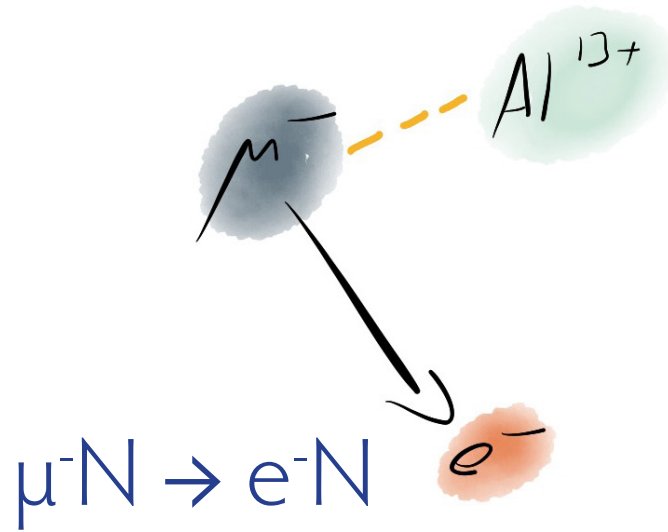
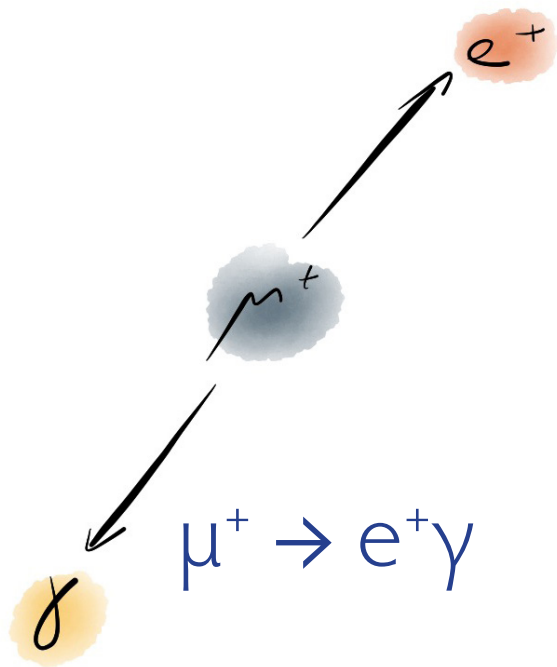

LFV Muon Decays: Experimental Situation

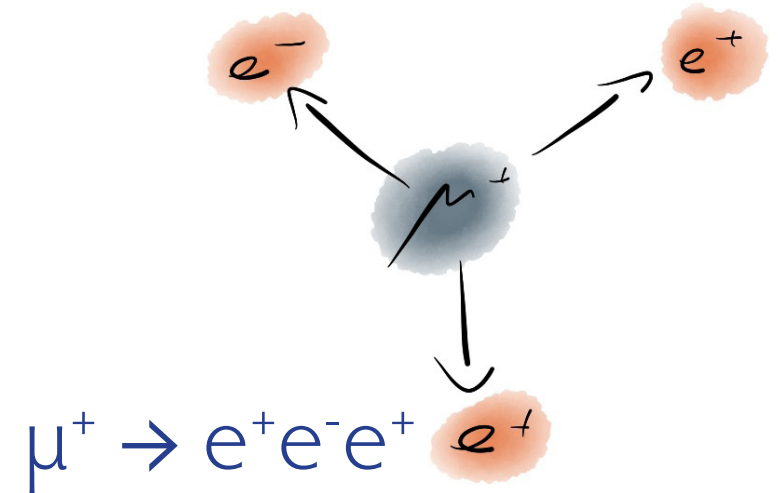
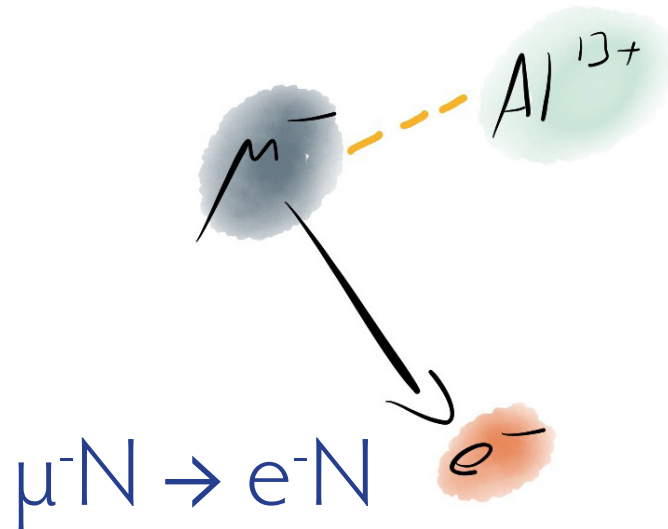
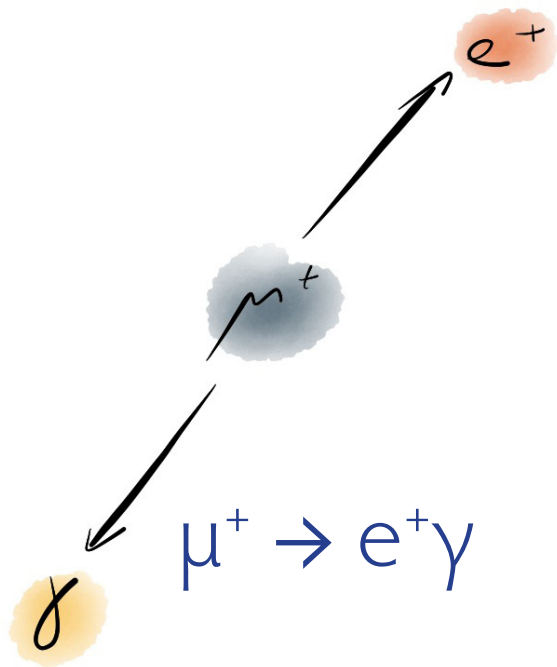

MEG (PSI)

$$B(\mu^+ \rightarrow e^+ \gamma) < 4.2 \cdot 10^{-13}$$

(2016)

SINDRUM II (PSI)

$$B(\mu^- \text{Au} \rightarrow e^- \text{Au}) < 7 \cdot 10^{-13}$$

(2006)

relative to nuclear capture

SINDRUM (PSI)

$$B(\mu^+ \rightarrow e^+ e^- e^+) < 1.0 \cdot 10^{-12}$$

(1988)

LFV Muon Decays: Experimental signatures

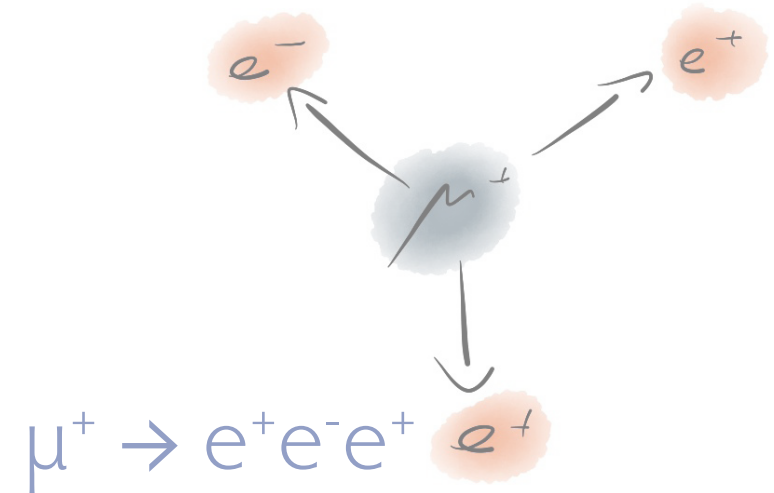
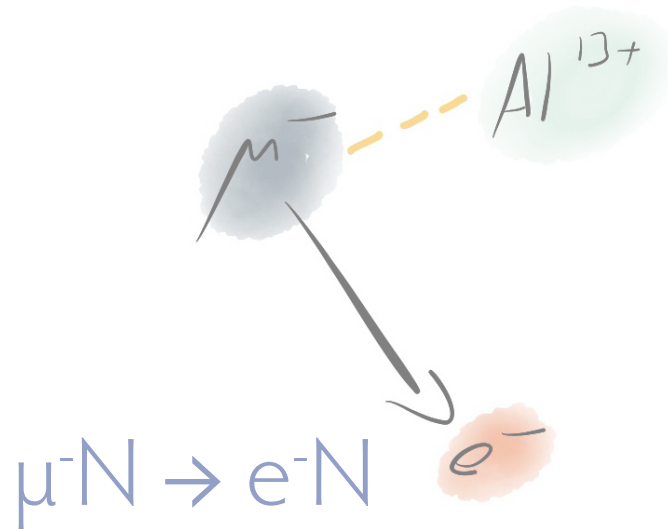
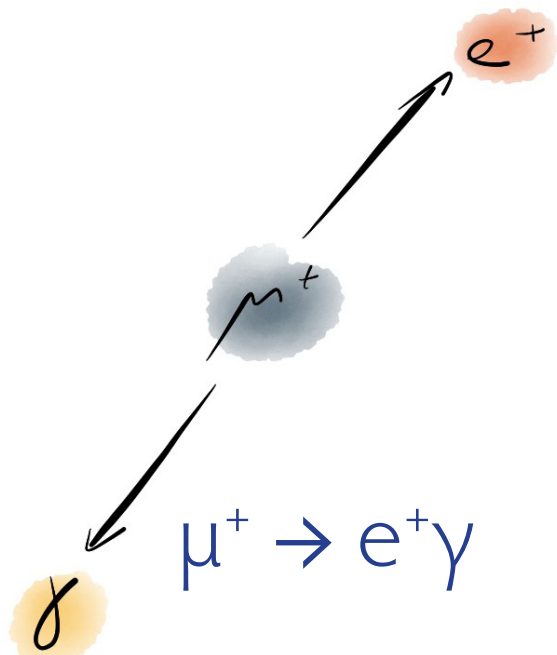

Kinematics

- 2-body decay
- Monoenergetic e^+ , γ
- Back-to-back

LFV Muon Decays: Experimental signatures

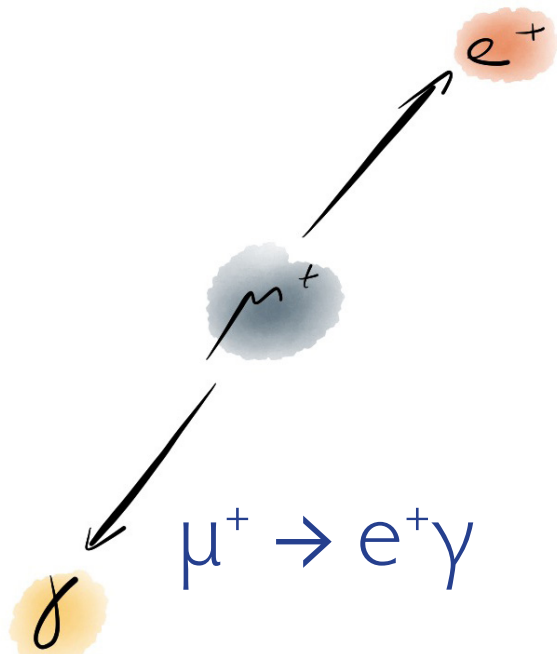

$$\mu^+ \rightarrow e^+ \gamma$$

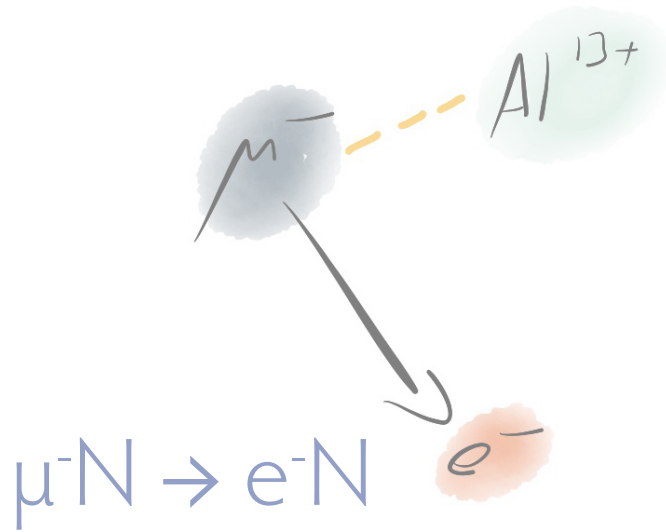

$$\mu^- N \rightarrow e^- N$$

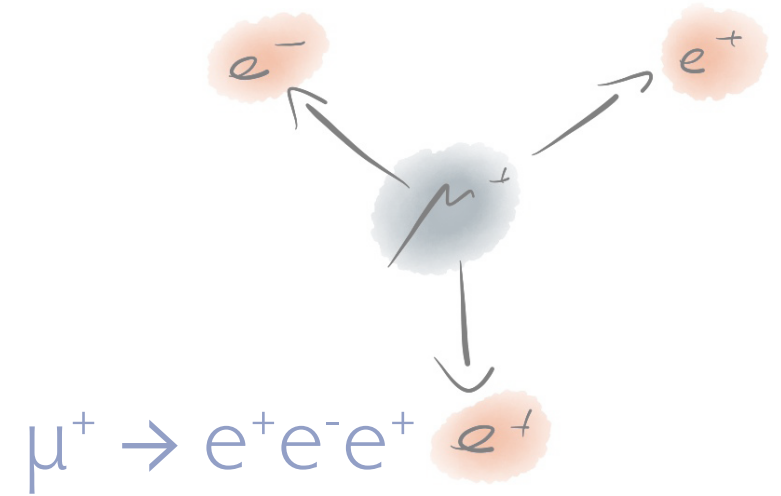

$$\mu^+ \rightarrow e^+ e^- e^+$$

Kinematics

- 2-body decay
- Monoenergetic e^+ , γ
- Back-to-back

Background

- Accidental background
- Radiative decay

LFV Muon Decays: Experimental signatures

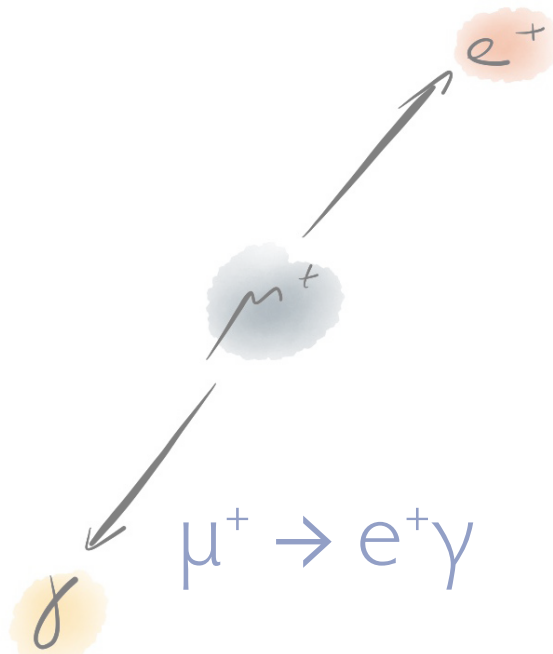

$$\mu^+ \rightarrow e^+ \gamma$$

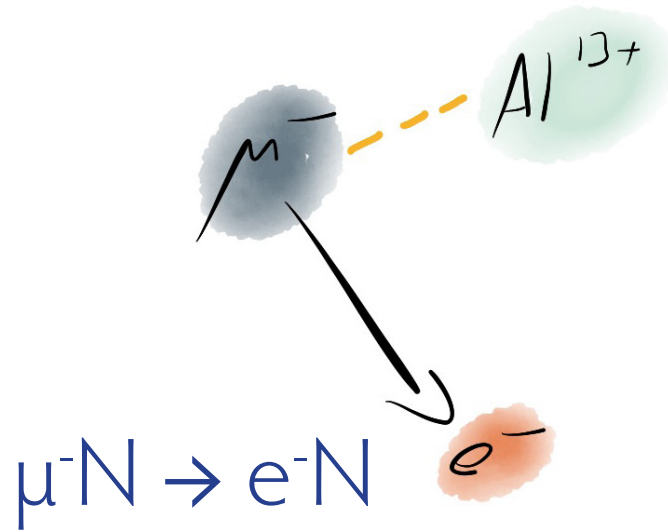

$$\mu^- N \rightarrow e^- N$$

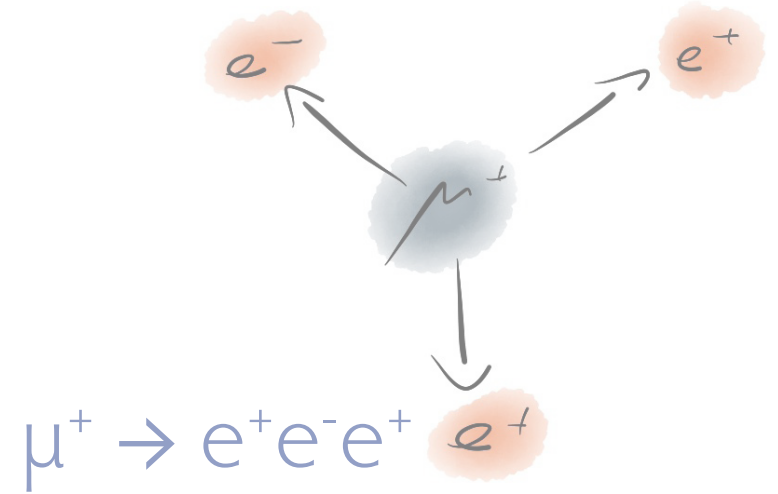

$$\mu^+ \rightarrow e^+ e^- e^+$$

Kinematics

- 2-body decay
- Monoenergetic e^+ , γ
- Back-to-back

Kinematics

- Quasi 2-body decay
- Monoenergetic e^-
- Single particle detected

Background

- Accidental background
- Radiative decay

LFV Muon Decays: Experimental signatures

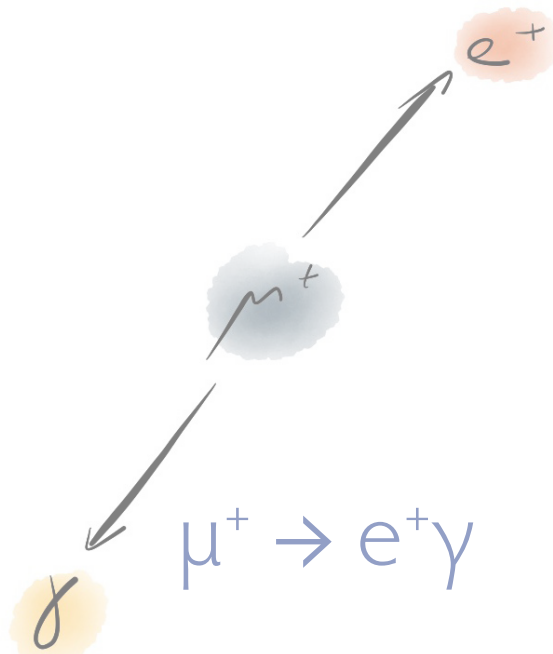

$$\mu^+ \rightarrow e^+ \gamma$$

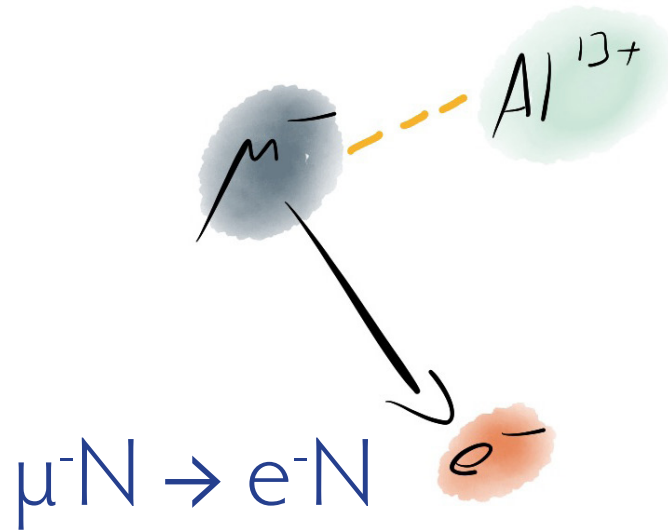

$$\mu^- N \rightarrow e^- N$$

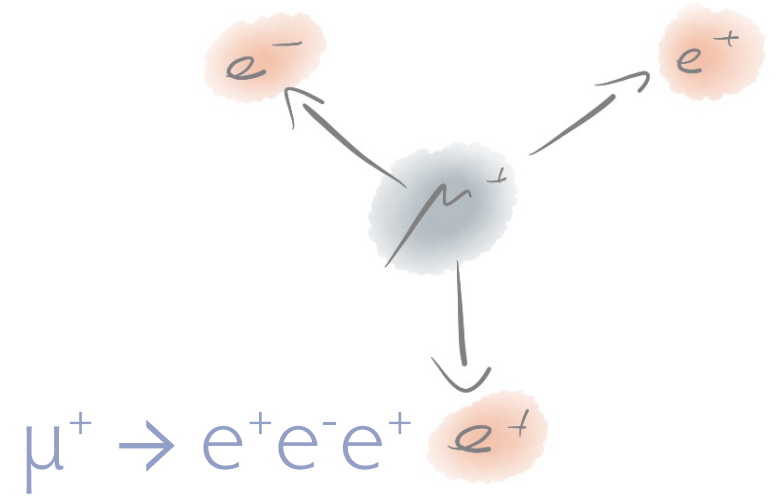

$$\mu^+ \rightarrow e^+ e^- e^+$$

Kinematics

- 2-body decay
- Monoenergetic e^+ , γ
- Back-to-back

Background

- Accidental background
- Radiative decay

Kinematics

- Quasi 2-body decay
- Monoenergetic e^-
- Single particle detected

Background

- Decay in orbit
- Antiprotons, pions, cosmics

LFV Muon Decays: Experimental signatures

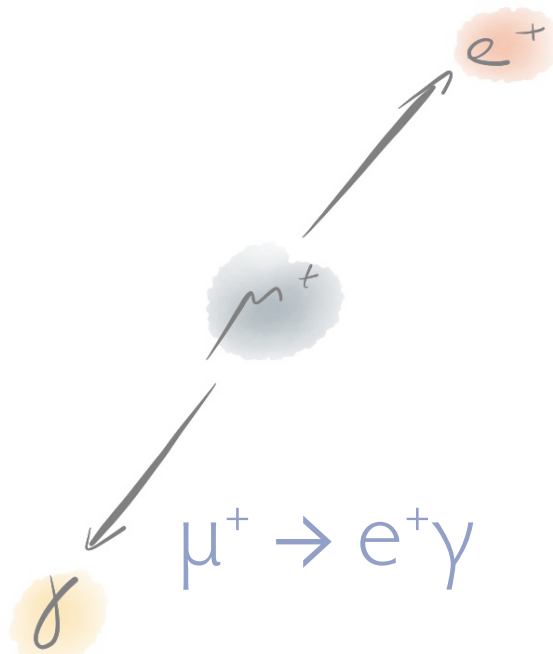

$$\mu^+ \rightarrow e^+ \gamma$$

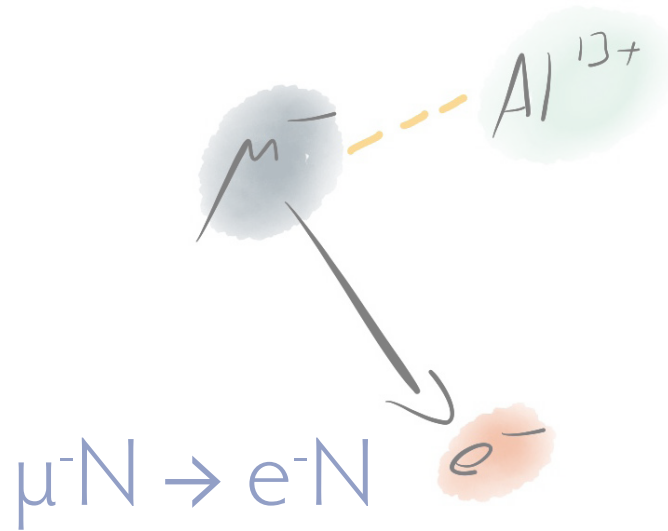

$$\mu^- N \rightarrow e^- N$$

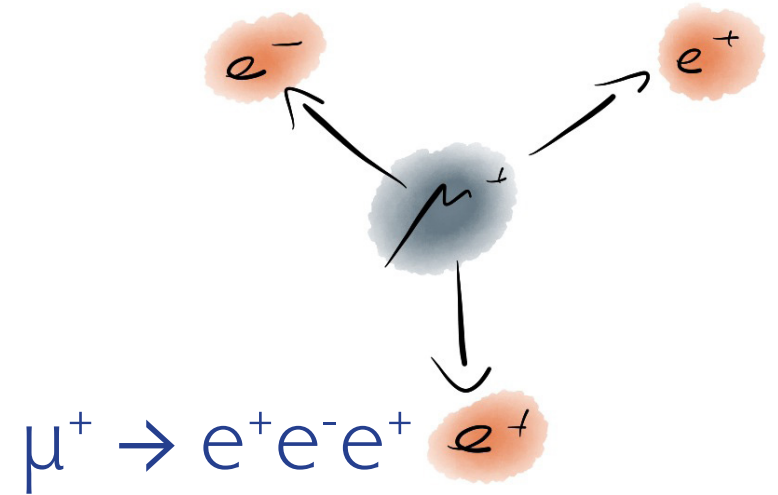

$$\mu^+ \rightarrow e^+ e^- e^+$$

Kinematics

- 2-body decay
- Monoenergetic e^+ , γ
- Back-to-back

Background

- Accidental background
- Radiative decay

Kinematics

- Quasi 2-body decay
- Monoenergetic e^-
- Single particle detected

Background

- Decay in orbit
- Antiprotons, pions, cosmics

Kinematics

- 3-body decay
- Invariant mass constraint
- $\sum p_i = 0$

Background

- Internal conversion decay
- Accidental background

LFV Muon Decays: Experimental signatures

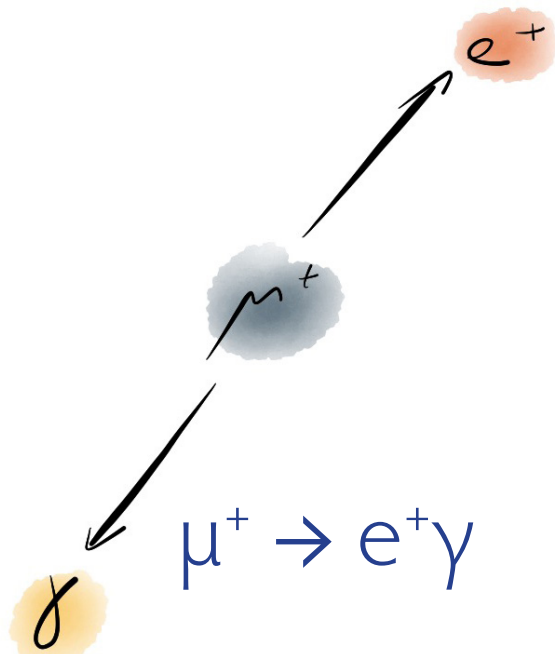

$$\mu^+ \rightarrow e^+ \gamma$$

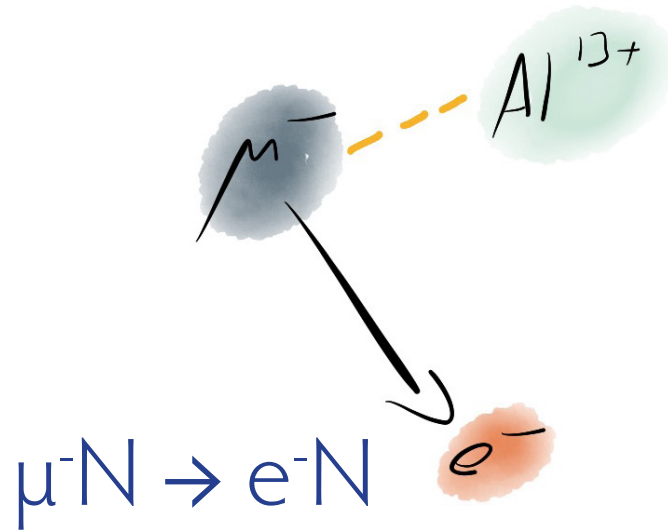

$$\mu^- N \rightarrow e^- N$$

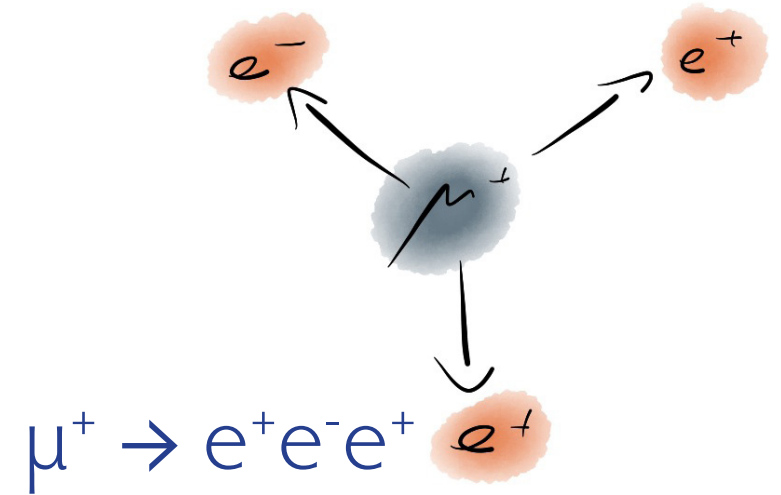

$$\mu^+ \rightarrow e^+ e^- e^+$$

Kinematics

- 2-body decay
- Monoenergetic e^+ , γ
- Back-to-back

Background

- Accidental background
- Radiative decay

Kinematics

- Quasi 2-body decay
- Monoenergetic e^-
- Single particle detected

Background

- Decay in orbit
- Antiprotons, pions, cosmics

Kinematics

- 3-body decay
- Invariant mass constraint
- $\sum p_i = 0$

Background

- Internal conversion decay
- Accidental background

LFV Muon Decays: Experimental signatures

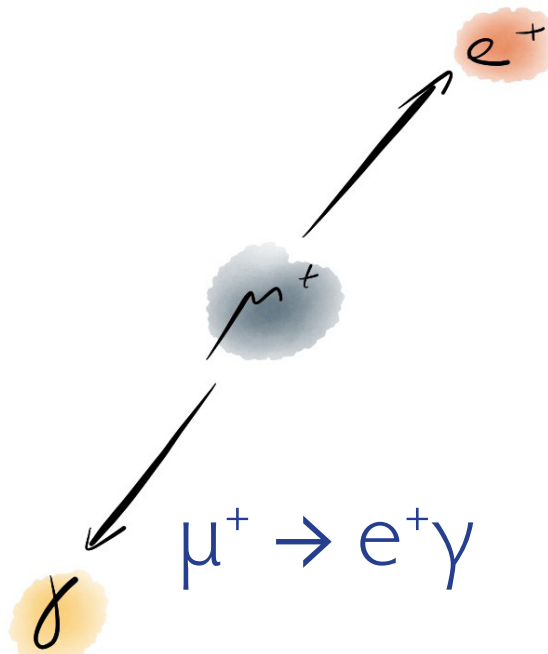

$$\mu^+ \rightarrow e^+ \gamma$$

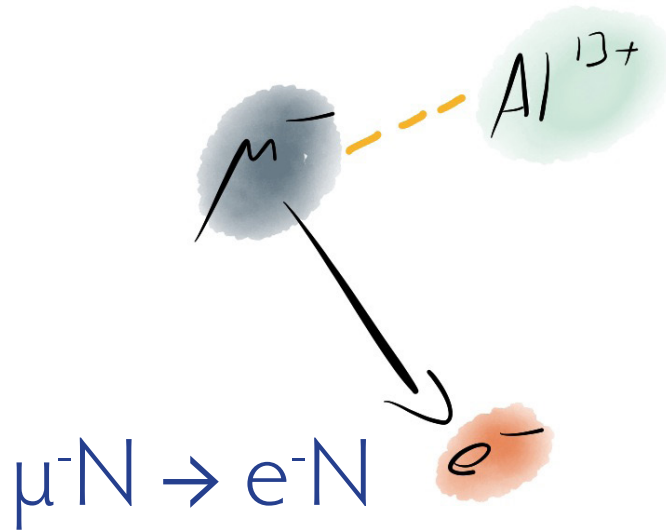

$$\mu^- N \rightarrow e^- N$$

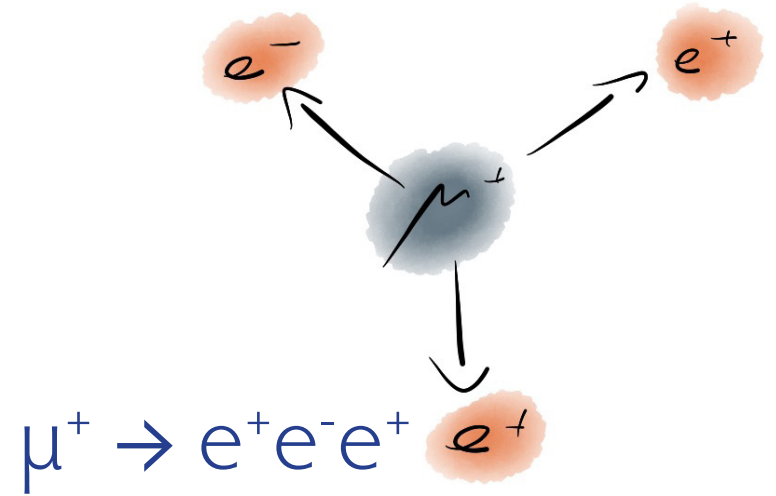

$$\mu^+ \rightarrow e^+ e^- e^+$$

Kinematics

- 2-body decay
- Monoenergetic
- Back-to-back

Background

- Atomic background

Continuous Beam

Kinematics

- Quasi 2-body decay
- Monoenergetic
- Single particle detected

Background

- Γ orbit
- Atomic protons, pions

Pulsed Beam

Kinematics

- 3-body decay
- Invariant mass constraint
- $\sum p_i = 0$

Background

- Radiative decay
- Atomic background

Continuous Beam

Precision vs. Acceptance

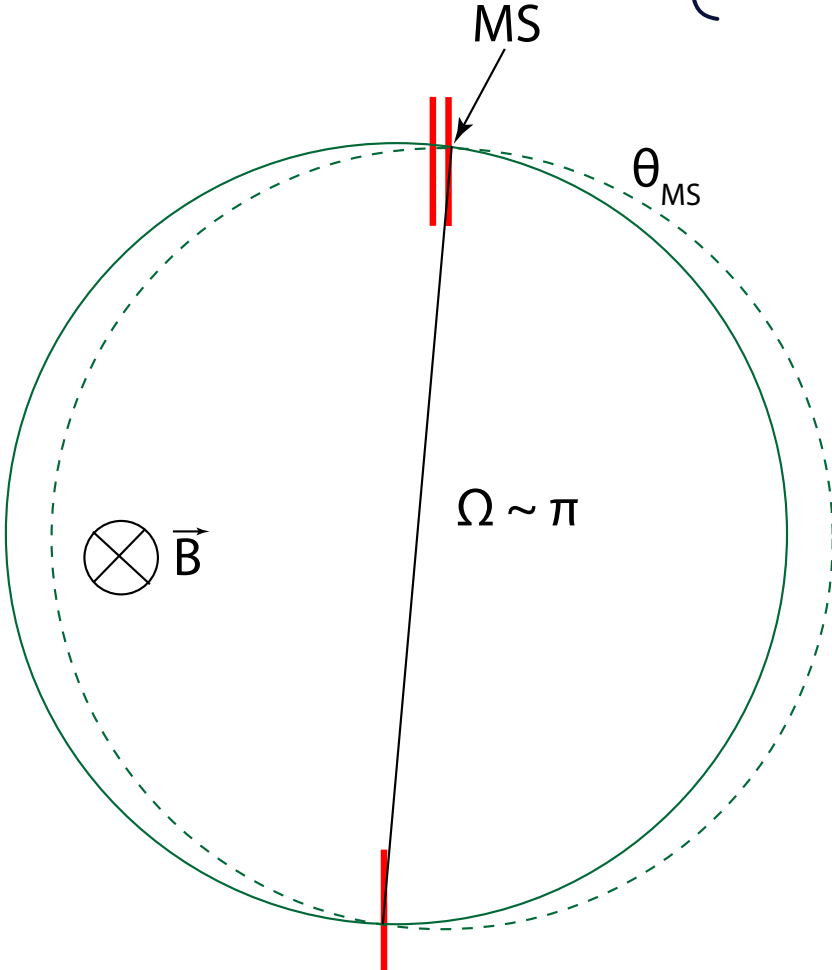
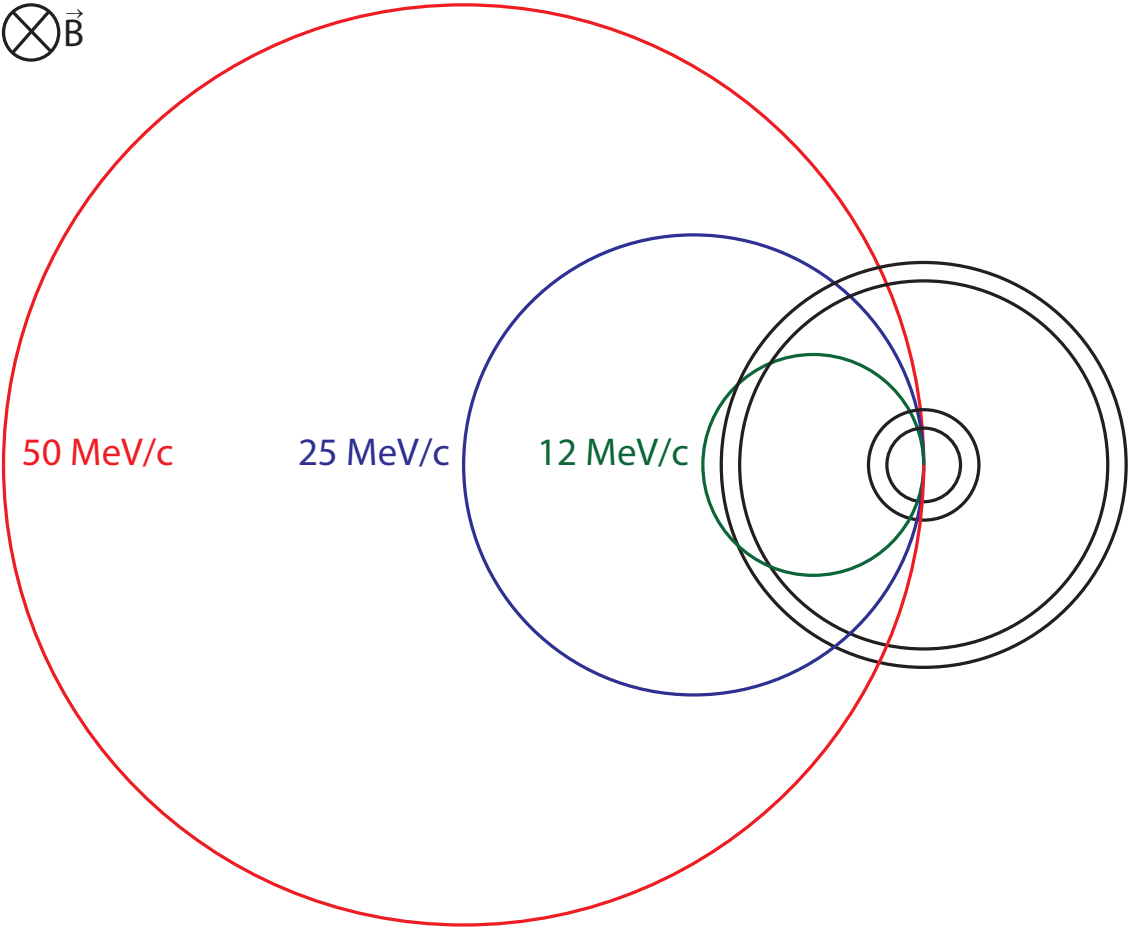

Phase I Data Acquisition and Filter Farm

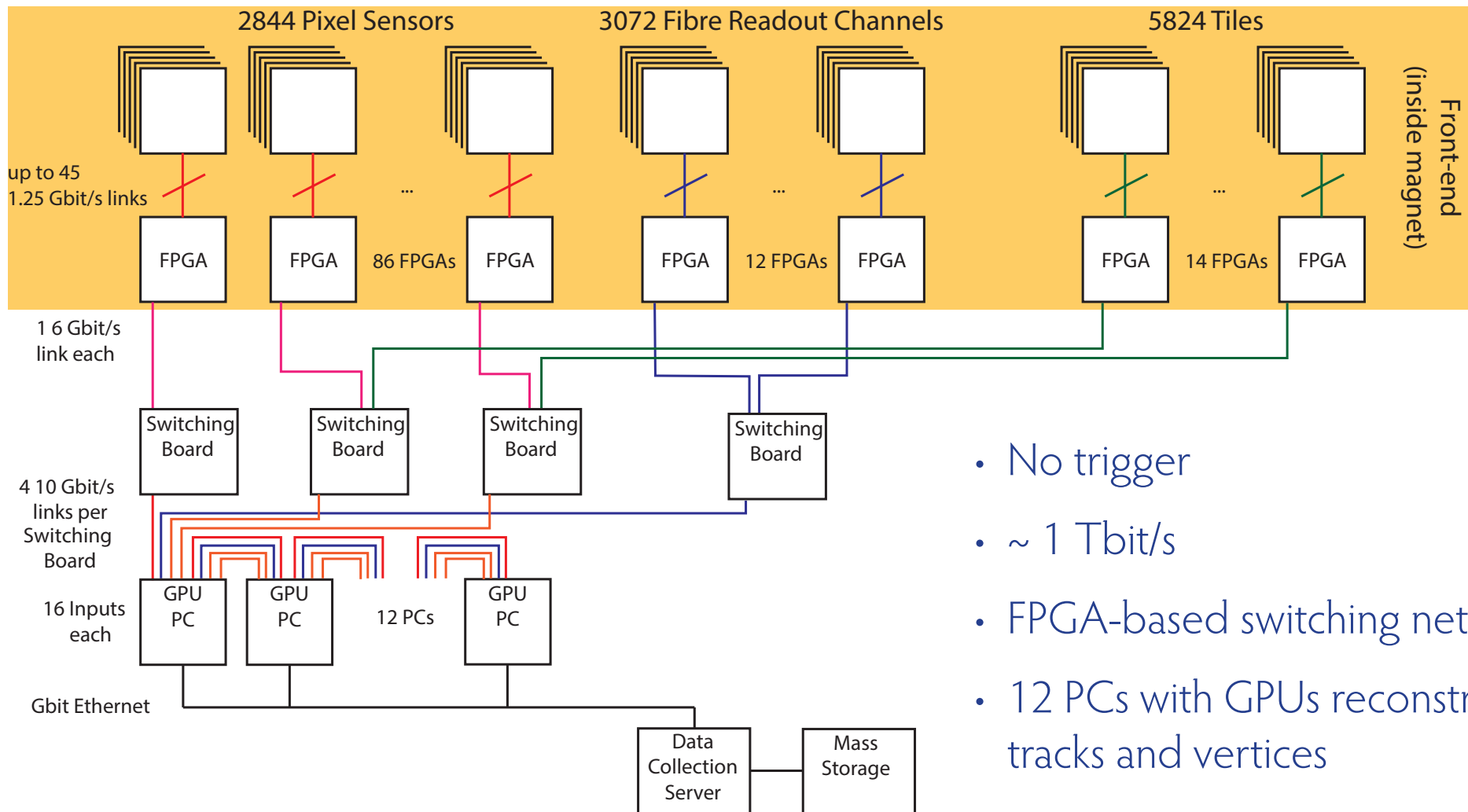

- No trigger
- ~ 1 Tbit/s
- FPGA-based switching network
- 12 PCs with GPUs reconstruct tracks and vertices
- Only save things that look like $\mu^+ \rightarrow e^+e^-e^+$