

Search for BSM Higgs Bosons with ATLAS



Jochen Dingfelder
University of Bonn



On behalf of the ATLAS Collaboration

SEARCH

SEARCH 2012 Workshop
University of Maryland, March 17-19, 2012

Overview

▶ Fermiophobic $H \rightarrow \gamma\gamma$

New prelim. results (4.9 fb⁻¹)

▶ MSSM neutral $h/H/A \rightarrow \tau\tau$

▶ Charged Higgs bosons

$$H^+ \rightarrow \tau_{\text{had}}\nu$$

$$H^+ \rightarrow \tau_{\text{lep}}\nu$$

$$H^+ \rightarrow c\bar{s}$$



New prelim. results (4.6 fb⁻¹)

▶ Doubly charged Higgs $H^{++} \rightarrow \mu^+\mu^+$

Published in PRD (1.6 fb⁻¹)

▶ NMSSM $a_1 \rightarrow \mu\mu$

Fermiophobic Higgs

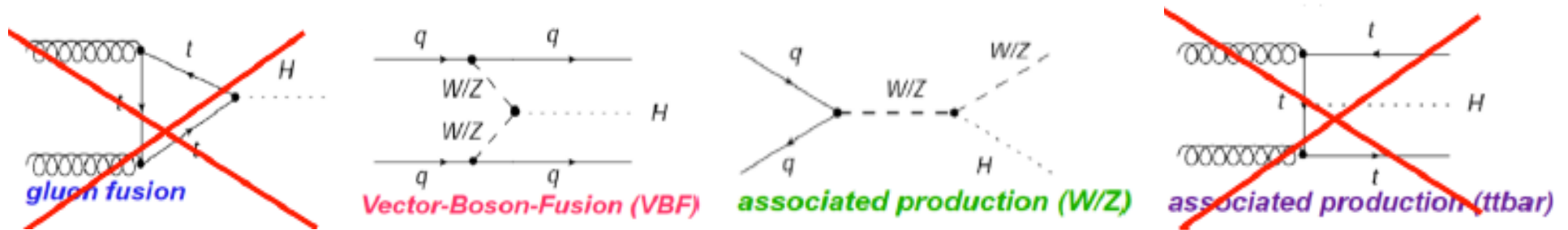

- **Suppressed Higgs couplings to fermions** in 2HDM and Higgs triplet models

Here: simple benchmark model (LEP)

- **no fermion-Higgs couplings**
 - **SM boson-Higgs couplings**
 - **Production:** Vector-boson fusion and associated production with W/Z
 - **Decays** to $\gamma\gamma$, WW, ZZ, $Z\gamma$
- Here: focus on $H \rightarrow \gamma\gamma$
- ⇒ **larger $\sigma \times \text{BR}$** than SM for light Higgs
 - ⇒ **higher Higgs p_T**

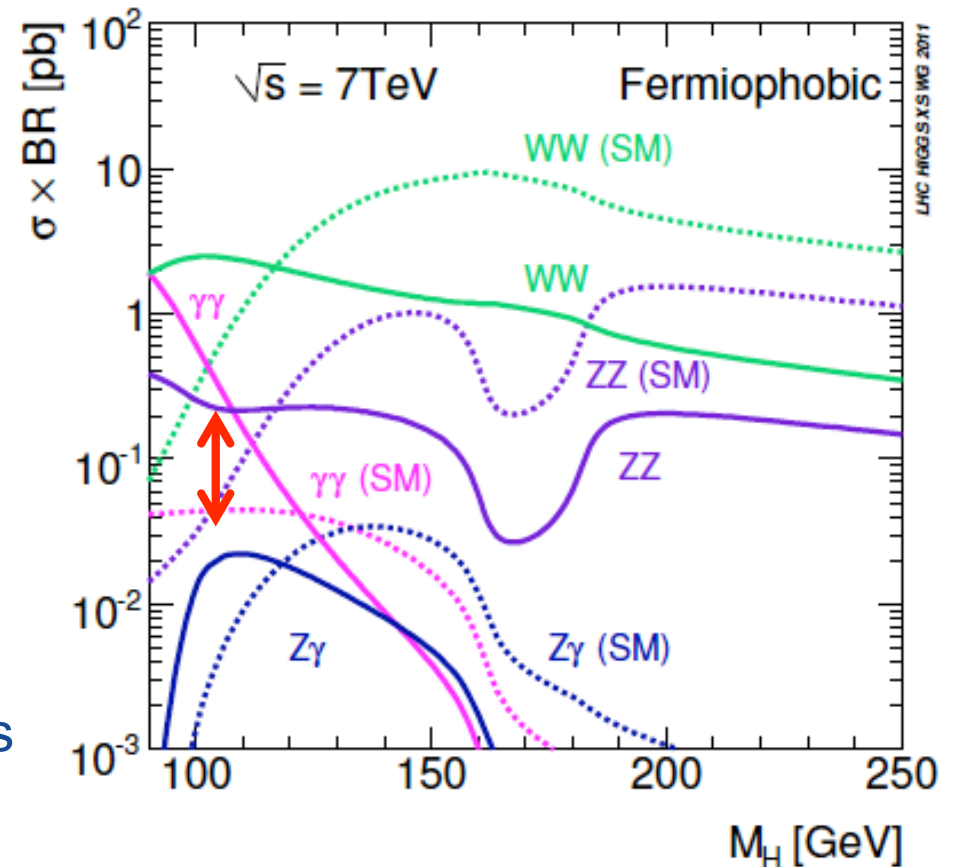

Fermiophobic Higgs $\rightarrow \gamma\gamma$

- **Selection:** (identical to SM $H \rightarrow \gamma\gamma$)
- **2 isolated photons** with $p_T > 40, 20$ GeV
- Di-photon mass: **$100 < m_{\gamma\gamma} < 160$ GeV**
- **9 categories** based on
 - presence of γ conversions
 - γ calorimeter **impact point**
 - p_{Tt} : related to di-photon p_T

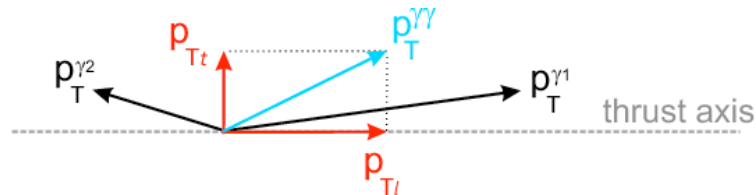

- **Signal $m_{\gamma\gamma}$ model**
Crystal Ball (core) + wide Gaussian (tail)
- **Background $m_{\gamma\gamma}$ model**
Exponential

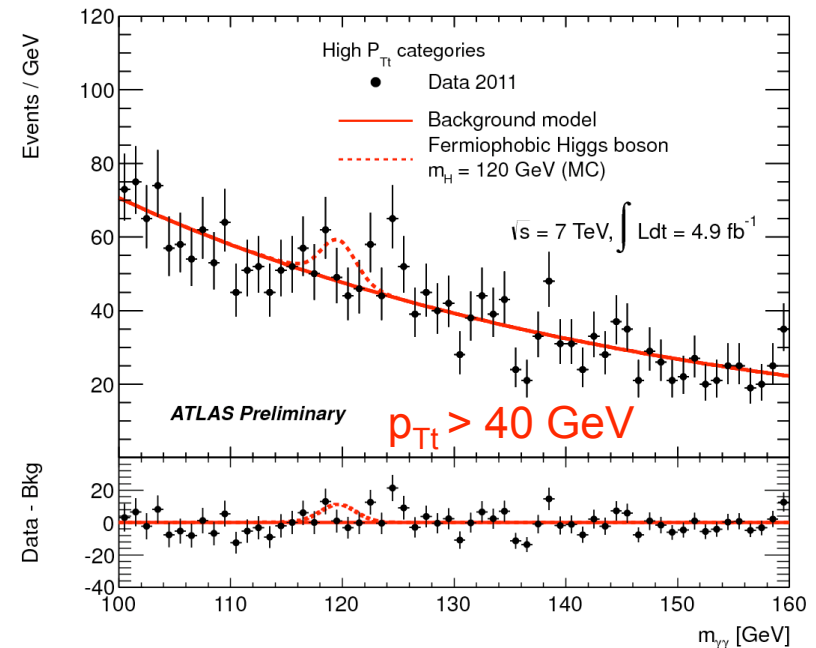
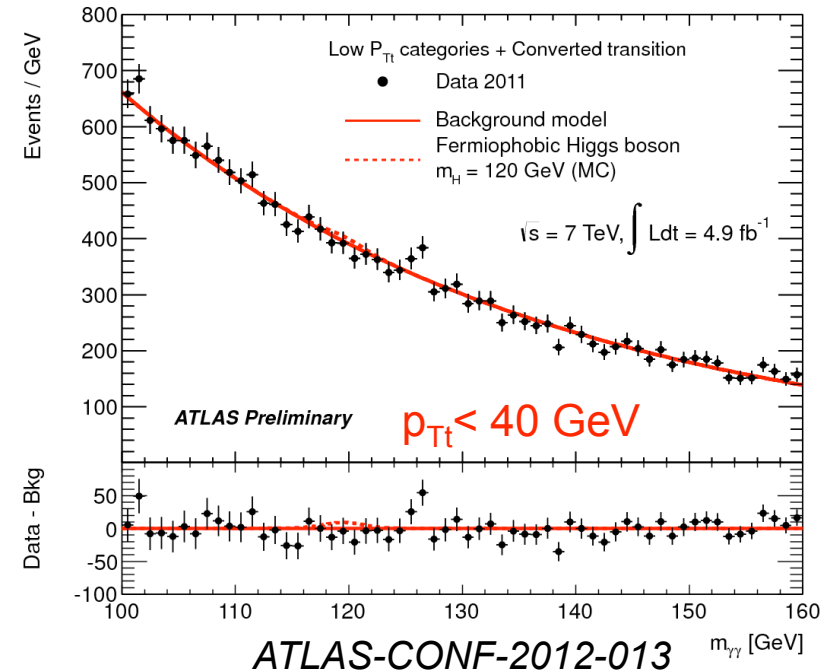

Fermiophobic Higgs $\rightarrow \gamma\gamma$: Exclusion limits

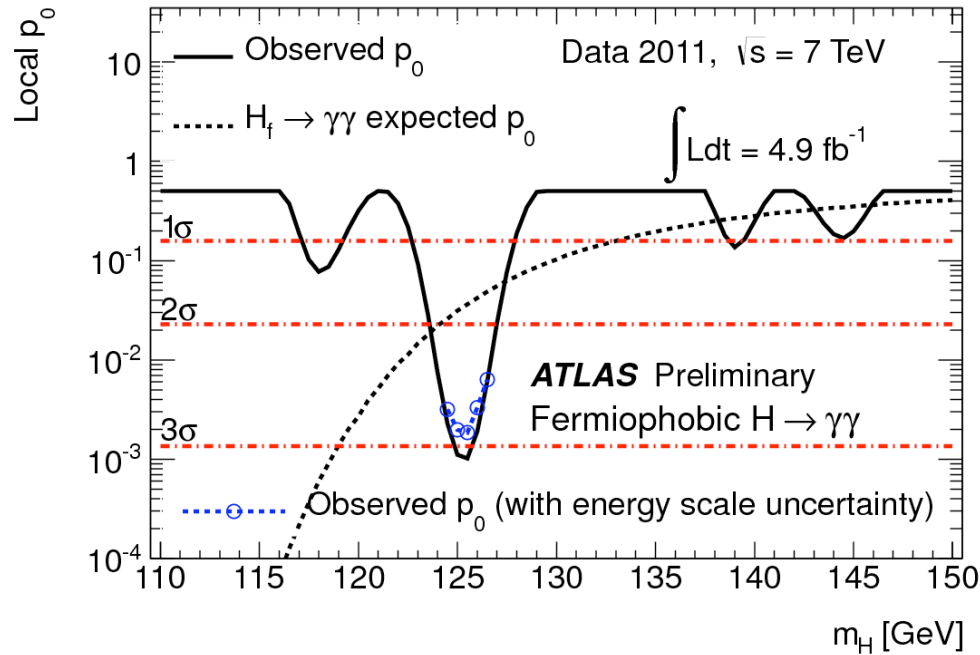

Largest excess at $m_H=125.5$ GeV

Including look-elsewhere effect:

Significance: 1.6σ

Prob. of background fluctuation: 5%

Observed m_H exclusion:

[110.0, 118.0], [119.5, 121.0]

Expected m_H exclusion:

[110.0, 123.5]

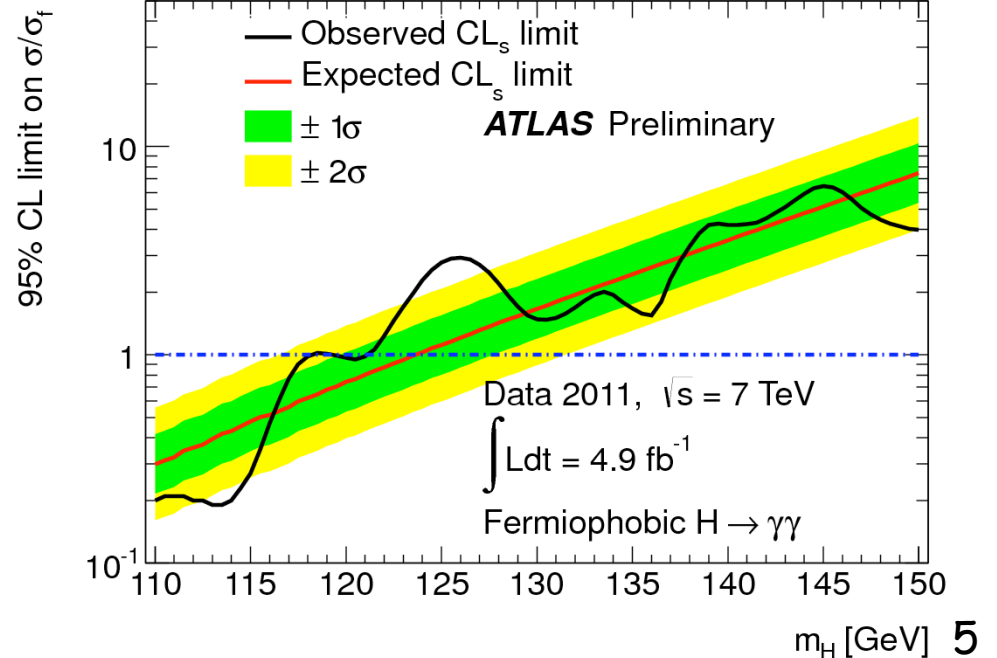

Neutral MSSM Higgs

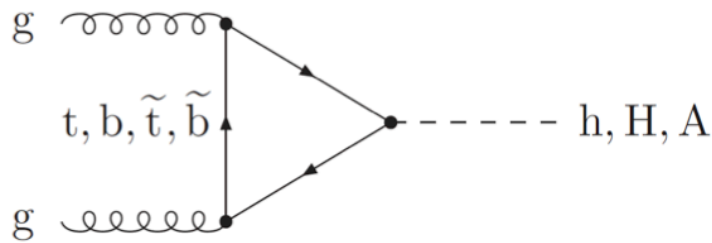

gluon-gluon fusion: $gg \rightarrow h/H/A$

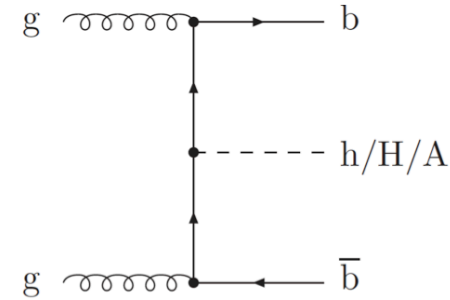

b-associated production: $bbh/H/A$

- **MSSM** requires 2 Higgs doublets
 \Rightarrow **5 Higgs bosons:**
 $\Phi = h, H, A ; H^+, H^-$
- h/H and A nearly mass degenerate
- 2 parameters at tree level: $m_A, \tan\beta$
- **Enhanced couplings to b and τ**
in large parts of parameter space
 $\sigma_{bbh/H/A} \propto \tan^2\beta$

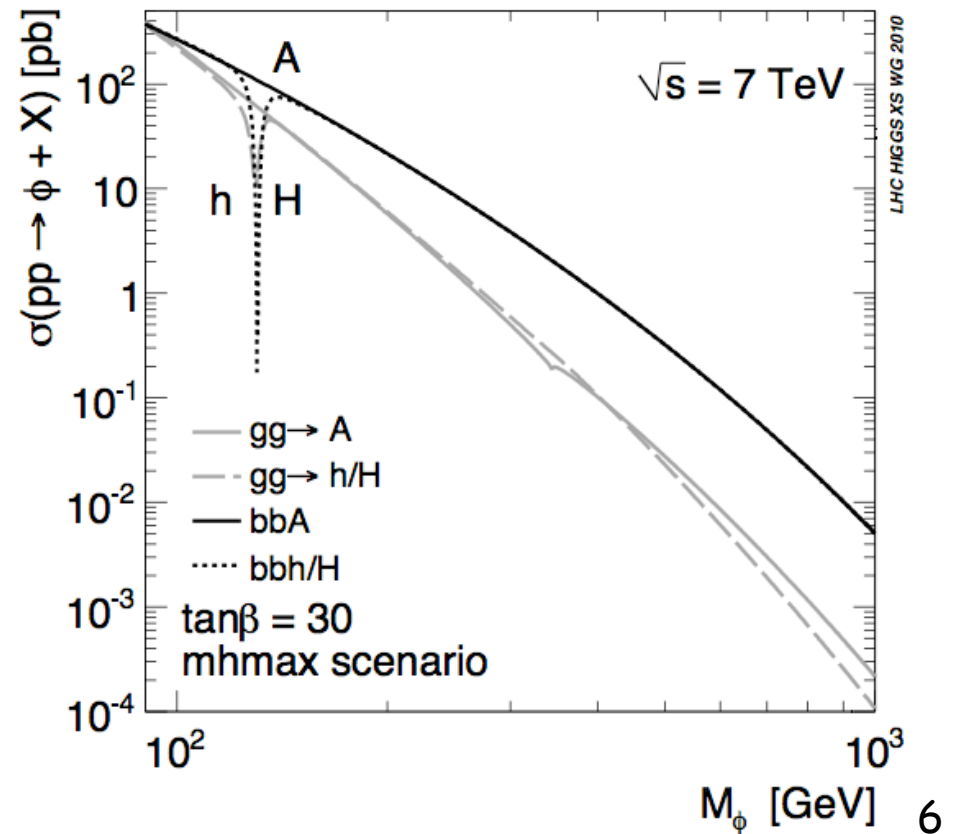

Tau signature and identification

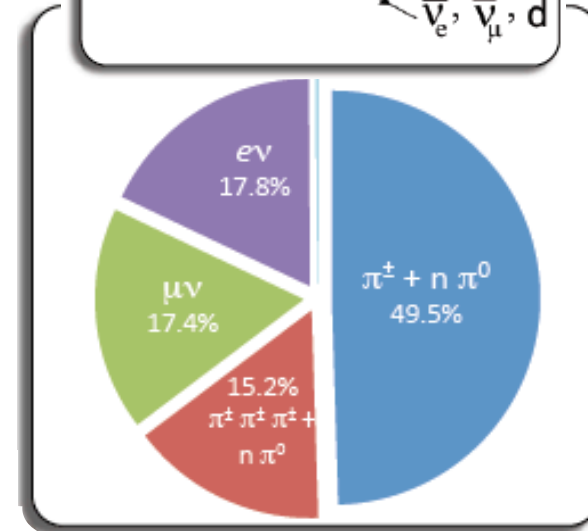
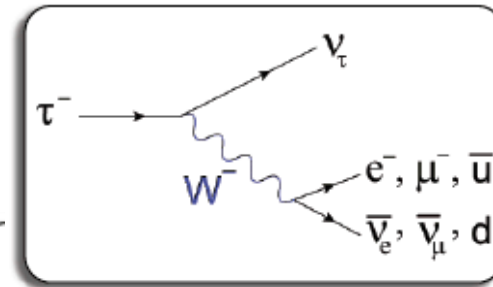
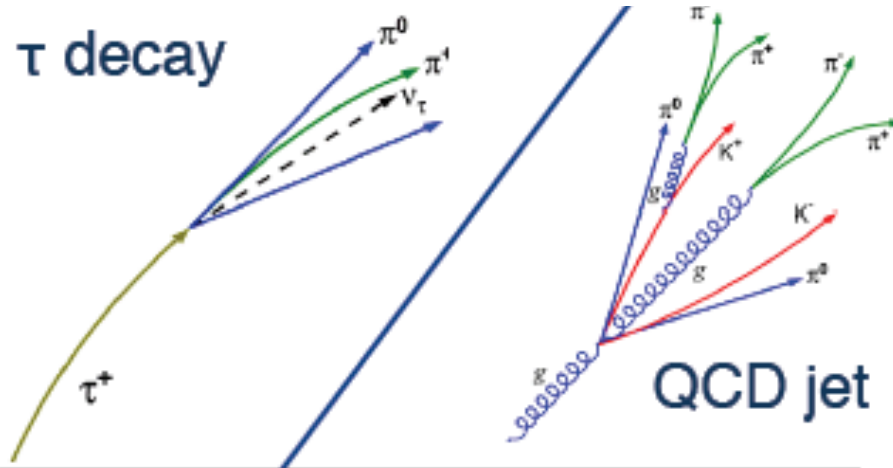

Hadronic τ decay (τ_{had}):

- Narrow, **collimated** jet
- **isolated** energy deposits and tracks
- large electromagnetic component
- **low track multiplicity (1 or 3)**
- high leading track momentum fraction

multivariate identification

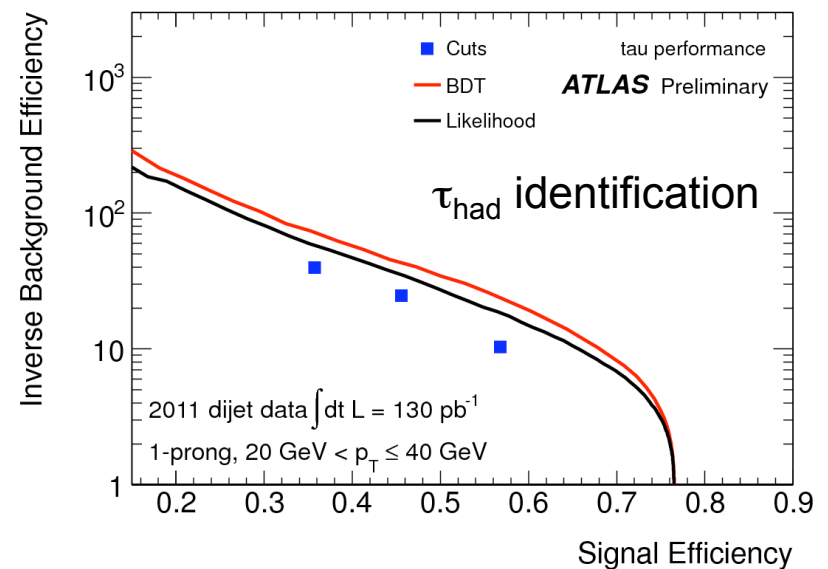

Neutral MSSM Higgs : Selection

$e + \mu$

- 1 isolated e with $p_T > 25$ GeV
- 1 isolated μ with $p_T > 20$ GeV
- Opposite charges
- $E_T^{\text{miss}} + p_{T,e} + p_{T,\mu} < 120$ GeV
- $\Delta\Phi(e,\mu) > 2.0$ rad
- (top, WW, ZZ suppression)

$e/\mu + \tau_{\text{had}}$

- 1 isolated e / μ with $p_T > 25 / 20$ GeV
- 1 τ_{had} with $p_T > 20$ GeV
- Opposite charges
- Di-lepton veto (Z, top)
- $E_T^{\text{miss}} > 20$ GeV (QCD)
- $m_T < 30$ GeV (W)

$\tau_{\text{had}} + \tau_{\text{had}}$

- **Di- τ_{had} trigger**
- 2 τ_{had} with $p_T > 45 / 30$ GeV
- Opposite charges
- $E_T^{\text{miss}} > 25$ GeV (QCD suppression)

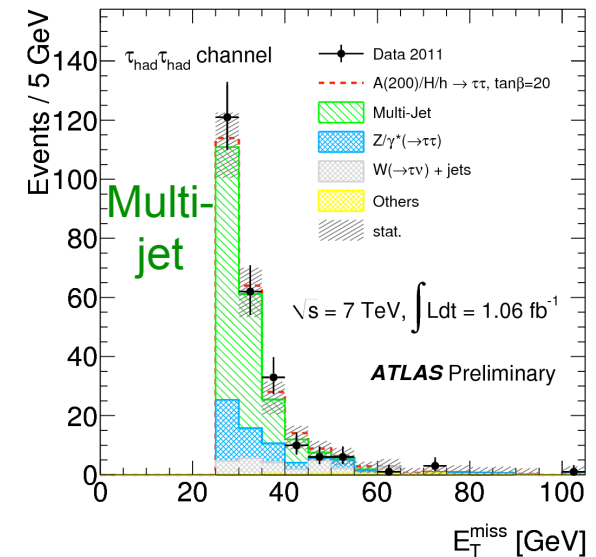
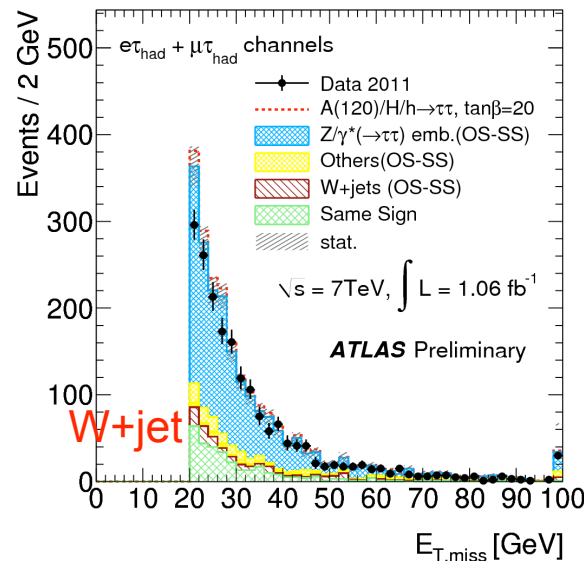
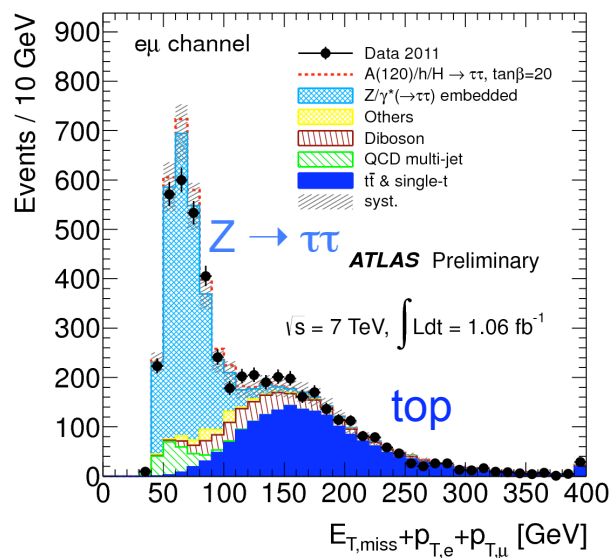

Neutral MSSM Higgs : Mass reconstruction

• **Visible mass** : $m_{\tau\tau}^{\text{visible}}$ (invariant mass of visible tau decay products)

• **Effective mass:** $m_{\tau\tau}^{\text{effective}} = \sqrt{(p_{\tau^+} + p_{\tau^-} + p_{\text{miss}})^2}$
 $p_{\text{miss}} = (E_T^{\text{miss}}, E_X^{\text{miss}}, E_Y^{\text{miss}}, 0)$

• **Missing mass calculator (MMC):**

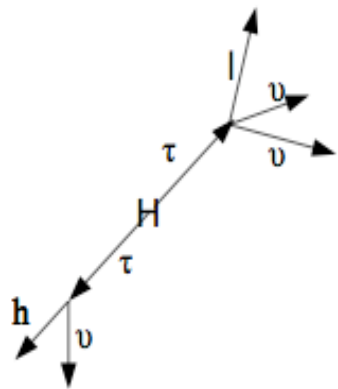

- 7 unknown parameters: two “missing” 3-momenta, $m_{\nu\nu}$
- 4 constraints from $E_X^{\text{miss}}, E_Y^{\text{miss}}, m_{\tau 1}, m_{\tau 2}$

- ⇒ scan over $\Delta\Phi(\nu, l), \Delta\Phi(\nu, h), m_{\nu\nu}$
- ⇒ weight solution according to probability of 3D angle in solution
- ⇒ **MMC mass** = Max. of weighted $m_{\tau\tau}$ distribution

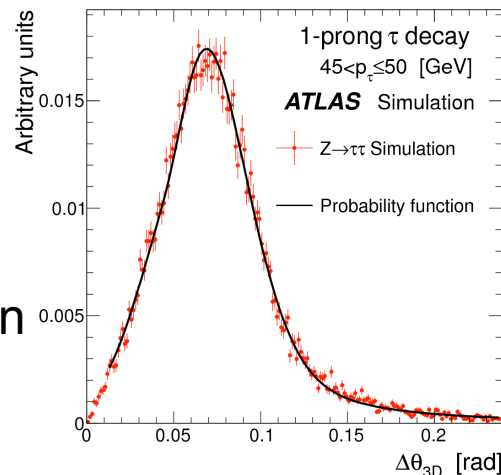

A.Elagin, P.Murat, A.Pranko, A.Safonov,
Nucl. Inst. Meth. A654 (2011) 481

Effective mass

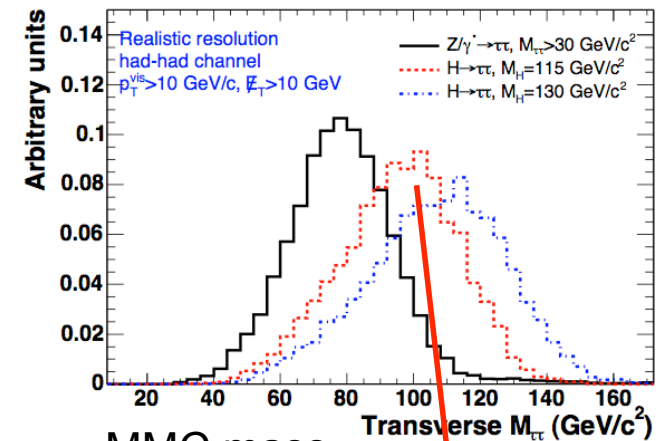

MMC mass

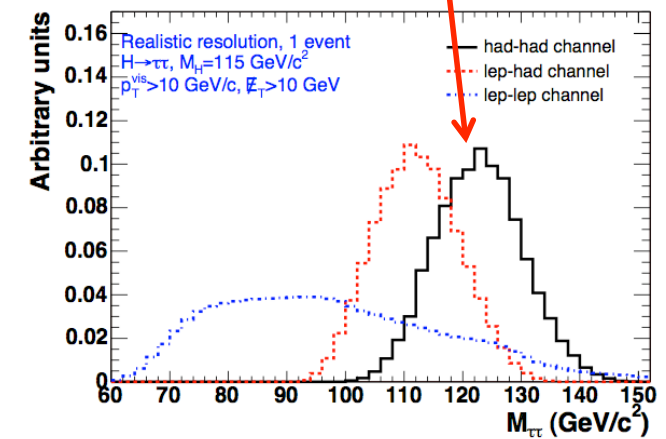

Neutral MSSM Higgs : Background estimation

Background estimation based on **data control samples**:

- $Z/\gamma^* \rightarrow \tau\tau$ from τ -embedded $Z/\gamma^* \rightarrow \mu\mu$ data sample
- **Multijet** background from samples with **same-sign charges** and **low E_T^{miss}** or **inverted lepton isolation**
- **W+jets** from high- $m_T(l, E_T^{\text{miss}})$ sample

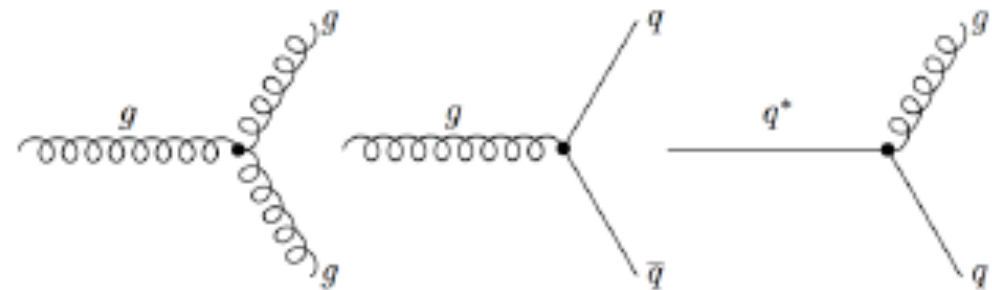
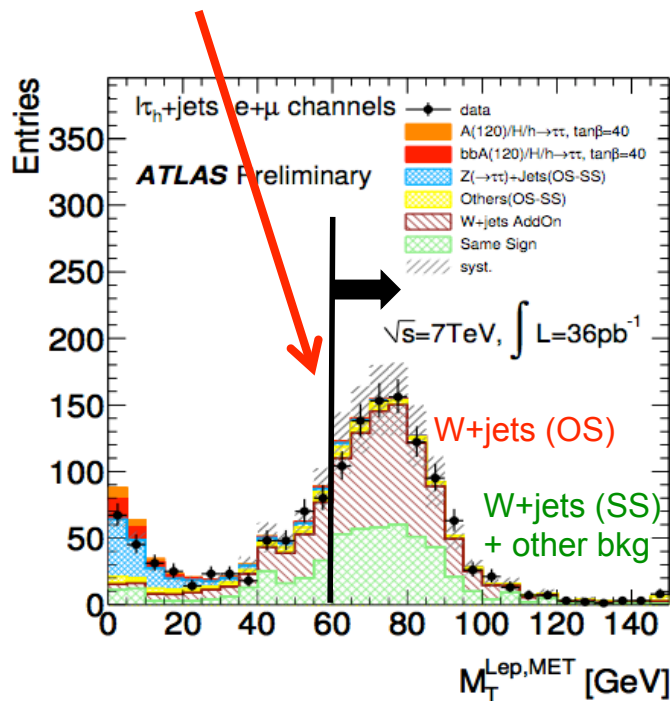
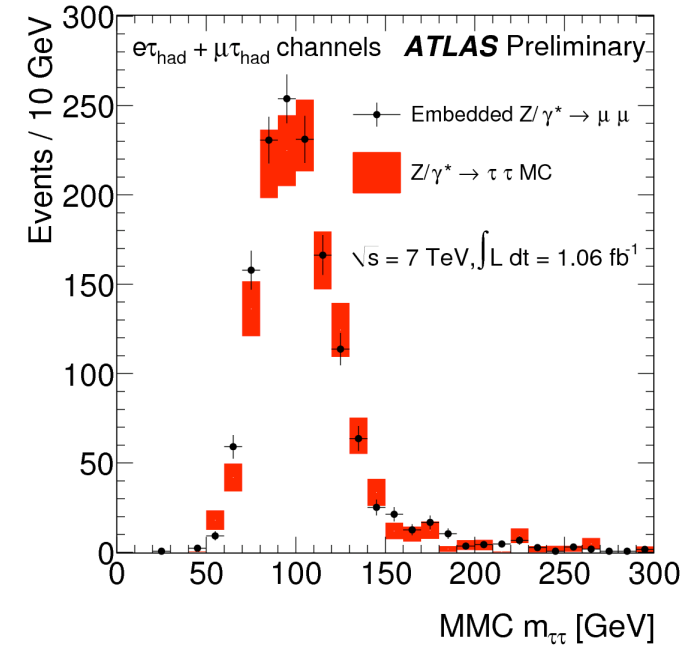

- No significant charge correlation
- Expect no large E_T^{miss}
- Mostly non-isolated or fake leptons

Neutral MSSM Higgs : Results

$e + \mu$

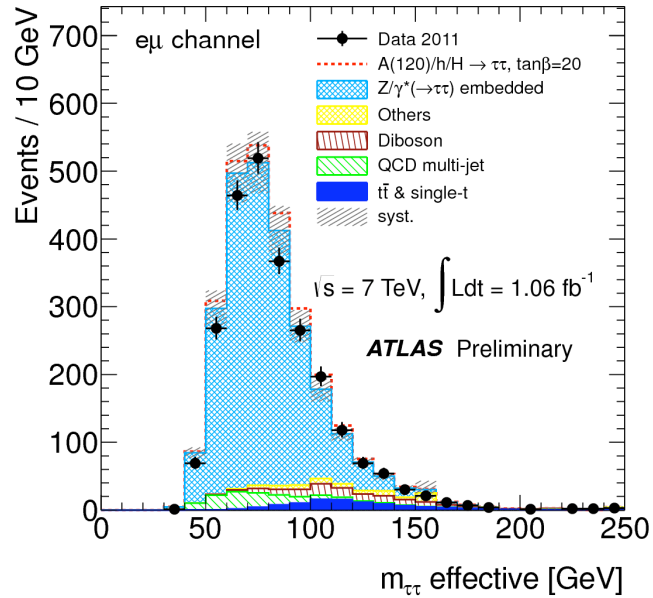

$e/\mu + \tau_{had}$

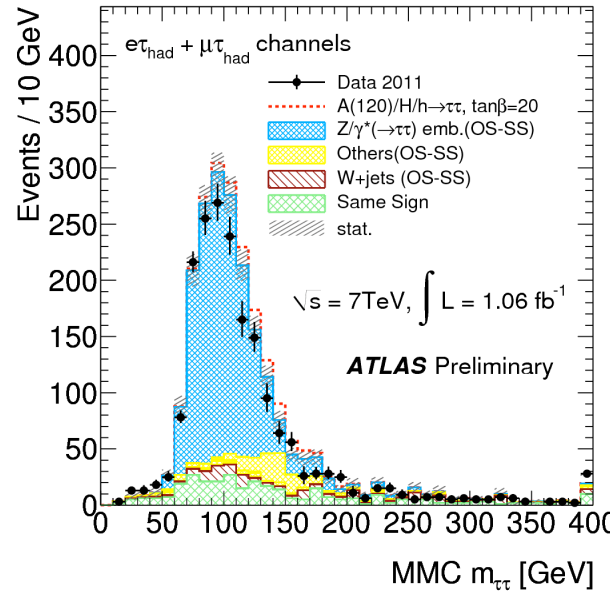

$\tau_{had} + \tau_{had}$

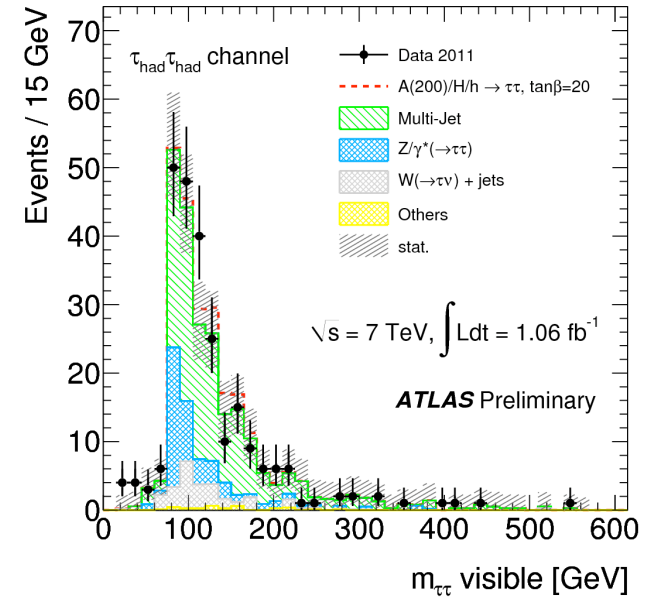

Final state	Exp. Background	Data
$e\mu$	$(2.6 \pm 0.2) \times 10^3$	2472
$\ell\tau_{had}$	$(2.1 \pm 0.4) \times 10^3$	1913
$\tau_{had}\tau_{had}$	233^{+44}_{-28}	245
Sum	$(4.9 \pm 0.6) \times 10^3$	4630

Neutral MSSM Higgs : Exclusion limits

$\sigma \times \text{BR} (\Phi \rightarrow \tau\tau)$

- Assume only one resonance (Φ):
100% $gg \rightarrow \Phi$ or
100% $bb\Phi$ production
(acceptances similar)
- Useful to test arbitrary models

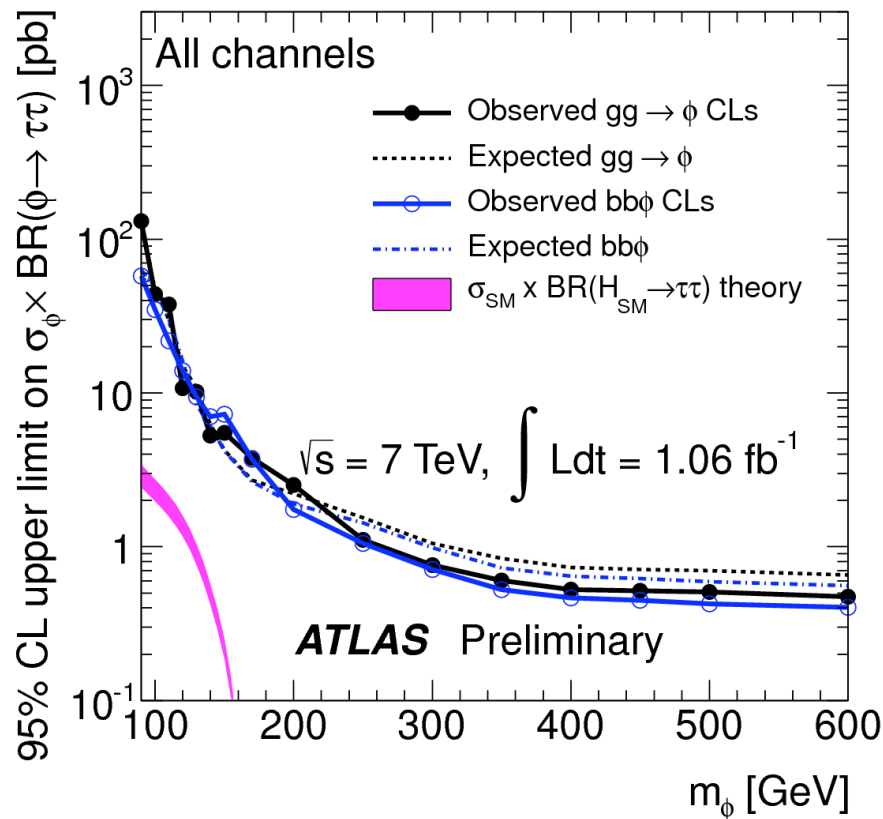

$(m_A, \tan\beta)$ plane

- Need to assume specific (c)MSSM scenario
- Here: m_h^{max} scenario

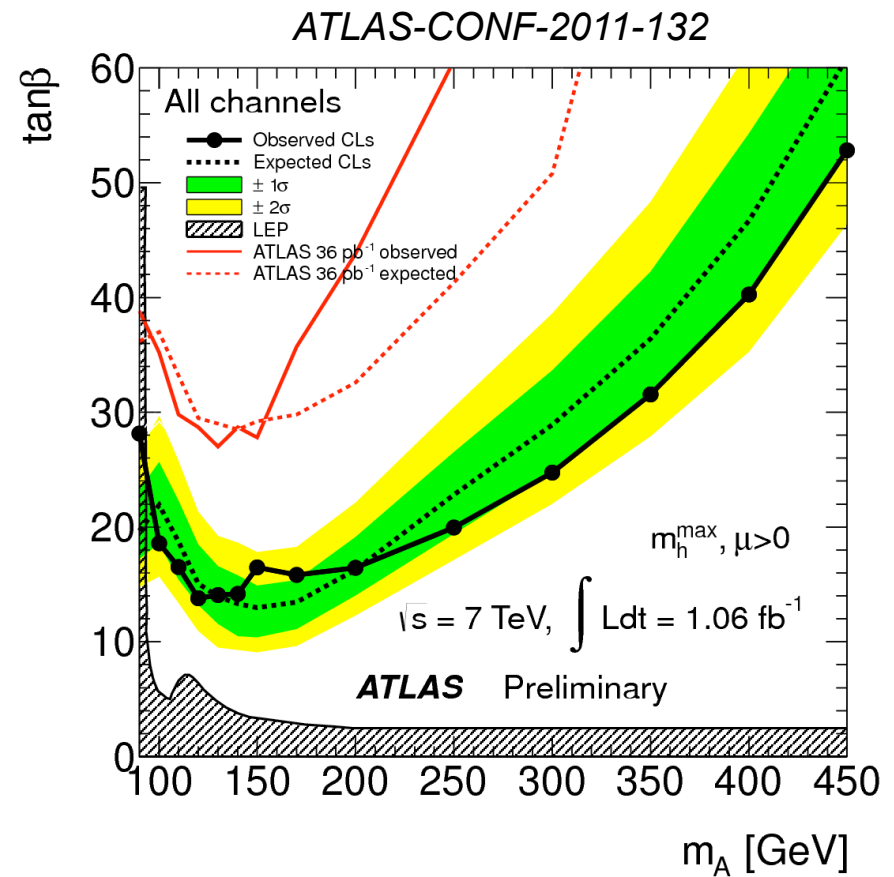

Neutral MSSM Higgs : Exclusion limits

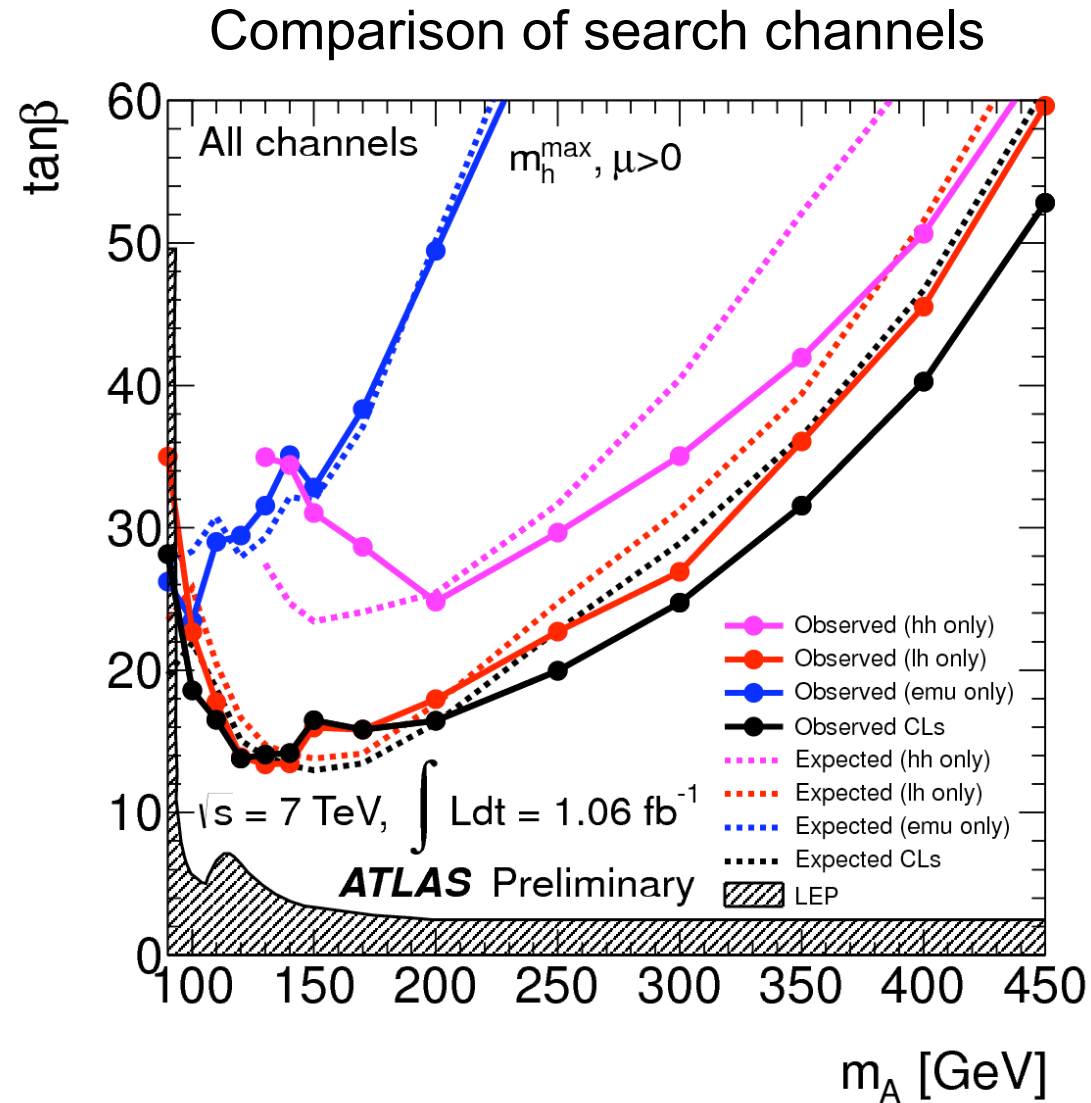

Update to full 4.9 fb^{-1} data set & inclusion of b-tagging in progress!

Charged Higgs

- Predicted in Higgs doublet (e.g. MSSM) and triplet models
- $m_{H^+} < m_t$: dominant **production in top quark decays**
- $m_{H^+} > m_t$: $gb \rightarrow tH^+$ production important, but more data needed
- for $\tan\beta > 3$, **preferred decay mode** is $H \rightarrow \tau\nu$ (here: assume BR of 100%)

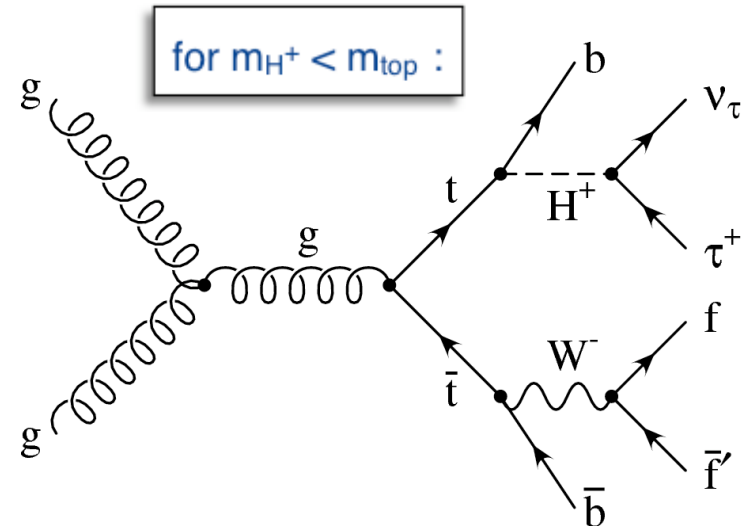

$$t\bar{t} \rightarrow b\bar{b}H^{\pm}W^{\mp} \rightarrow b\bar{b}(\tau_{lep}\nu)(q\bar{q}) : \text{lepton} + \text{jets}$$

$$t\bar{t} \rightarrow b\bar{b}H^{\pm}W^{\mp} \rightarrow b\bar{b}(\tau_{had}\nu)(\ell\nu) : \tau_{had} + \text{lepton}$$

$$t\bar{t} \rightarrow b\bar{b}H^{\pm}W^{\mp} \rightarrow b\bar{b}(\tau_{had}\nu)(q\bar{q}) : \tau_{had} + \text{jets}$$

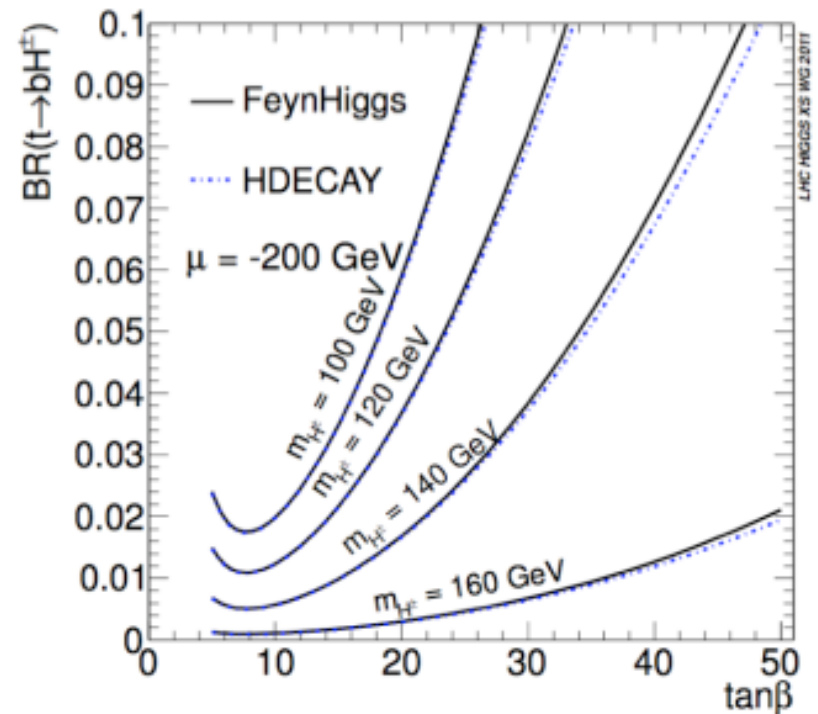

Charged Higgs: Lepton + jets channel

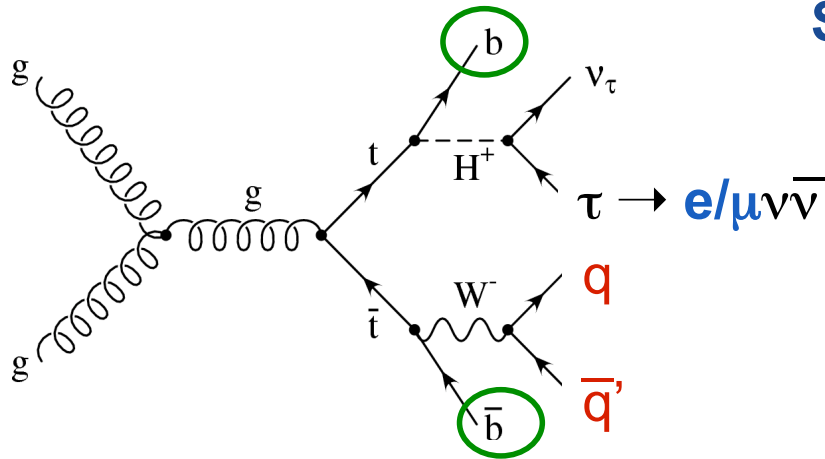

Selection:

- 1 isolated e / μ with $p_T > 25 / 20$ GeV
- ≥ 4 jets (**2 b-tagged**) with $p_T > 20$ GeV
- $E_T^{\text{miss}} > 40$ GeV if $|\Phi_{l,\text{miss}}| > \pi/6$
 $E_T^{\text{miss}} \times |\sin(\Phi_{l,\text{miss}})| > 20$ GeV if $|\Phi_{l,\text{miss}}| < \pi/6$
- Identify “**hadronic side**” by choosing combination of 1 b-jet and 2 light jets that minimizes $\chi^2 = \frac{(m_{jjb} - m_{\text{top}})^2}{\sigma_{\text{top}}^2} + \frac{(m_{jj} - m_W)^2}{\sigma_W^2}$

Discriminating variables:

$$\cos \theta_l^* = \frac{2m_{bl}^2}{m_{\text{top}}^2 - m_W^2} - 1 \simeq \frac{4 p^b \cdot p^l}{m_{\text{top}}^2 - m_W^2} - 1$$

$$(m_{\text{T}}^H)^2 = \left(\sqrt{m_{\text{top}}^2 + (\vec{p}_T^l + \vec{p}_T^b + \vec{p}_T^{\text{miss}})^2} - p_T^b \right)^2 - (\vec{p}_T^l + \vec{p}_T^{\text{miss}})^2$$

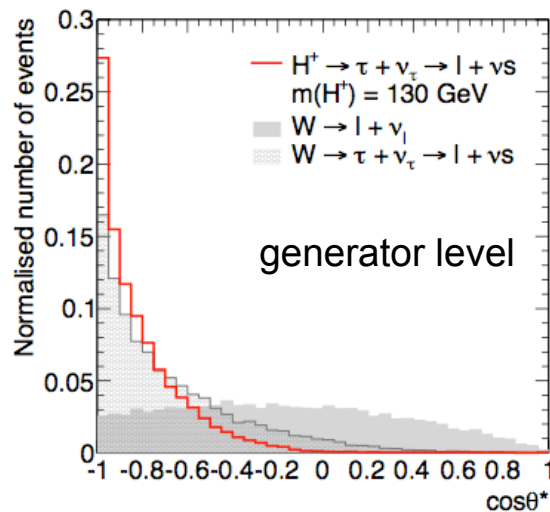

Discriminates between leptons from τ and W

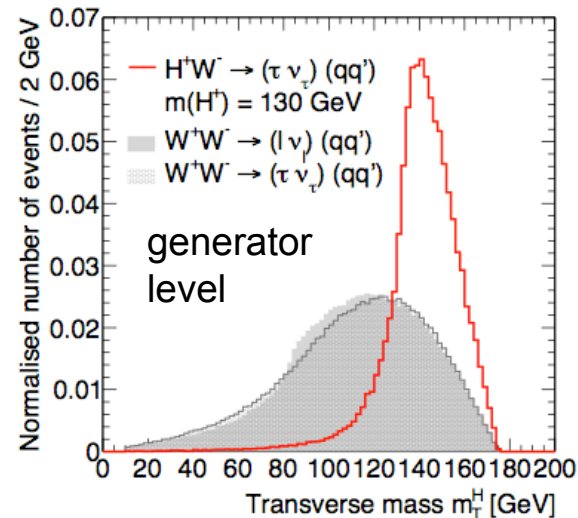

Lower bound \sim mass of charged boson (H^+ or W)

Charged Higgs: Lepton + jets channel

Signal region: $\cos\theta_1^* < -0.6$, $m_T(l, E_T^{\text{miss}}) < 60$ GeV

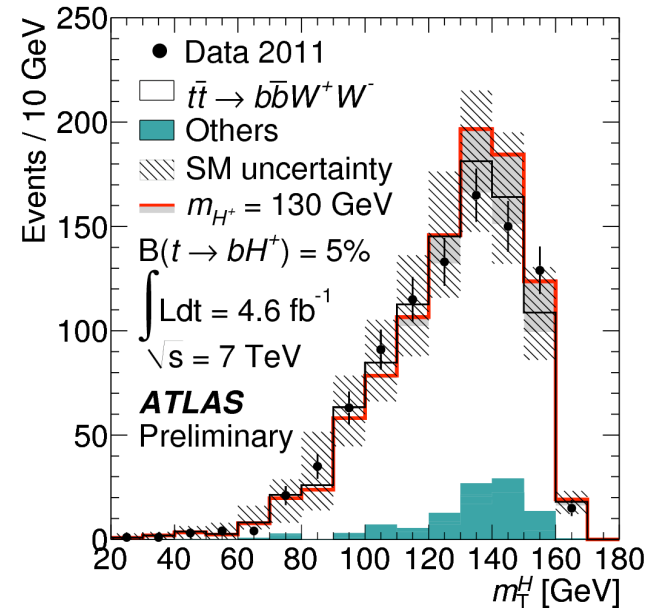
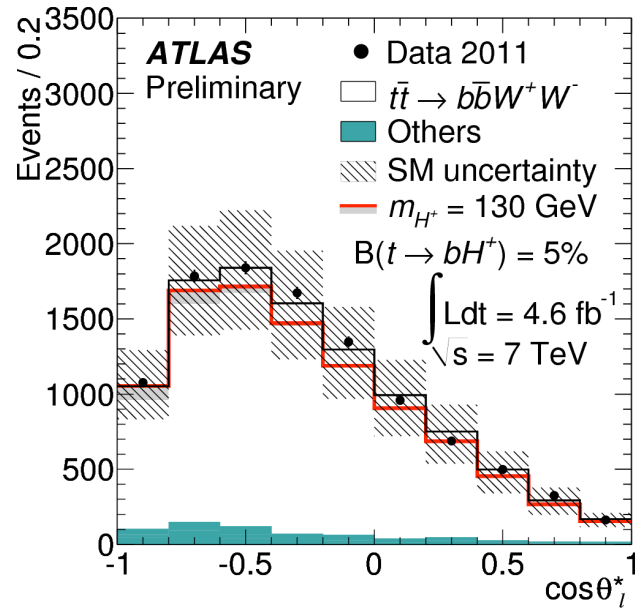

Sample	Event yield (lepton+jets)	
$t\bar{t}$	840	$\pm 20 \pm 150$
Single top quark	28	$\pm 2 \begin{smallmatrix} +8 \\ -6 \end{smallmatrix}$
W+jets	14	$\pm 3 \begin{smallmatrix} +6 \\ -3 \end{smallmatrix}$
Z+jets	2.1	$\pm 0.7 \begin{smallmatrix} +1.2 \\ -0.4 \end{smallmatrix}$
Diboson	0.5	$\pm 0.1 \pm 0.2$
Misidentified leptons	55	$\pm 10 \pm 20$
Σ SM	940	$\pm 22 \pm 150$
Data	933	
$t \rightarrow bH^+$ (130 GeV)	120	$\pm 4 \pm 25$

Dominant background from **top pairs!**

Simulated with MC@NLO, normalized in $-0.2 < \cos\theta_1^* < 1$

Misidentified-lepton background determined from control sample with **loosened** lepton ID

Charged Higgs: $\tau_{had} + \text{lepton channel}$

Selection:

- 1 isolated e / μ with $p_T > 25 / 20$ GeV
- 1 τ_{had} with $p_T > 20$ GeV
- ≥ 2 jets (≥ 1 **b-tagged**) with $p_T > 20$ GeV
- Sum of primary-vertex track p_T :
 $\Sigma p_T > 100$ GeV

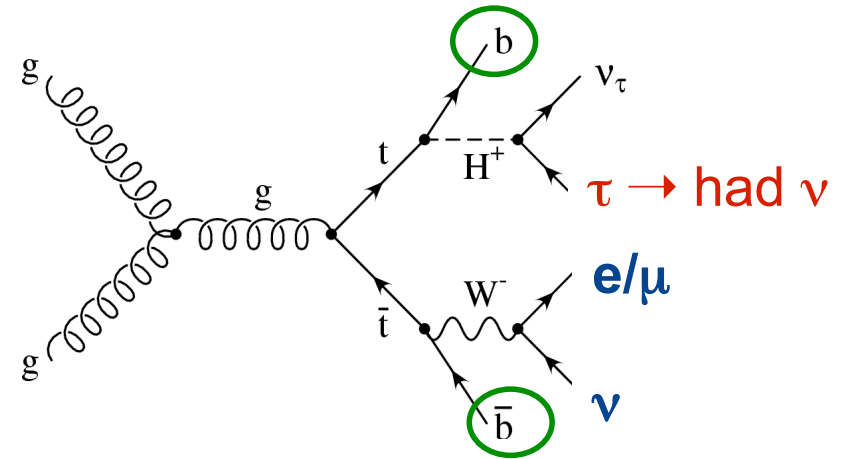

Discriminating
variable: E_T^{miss}

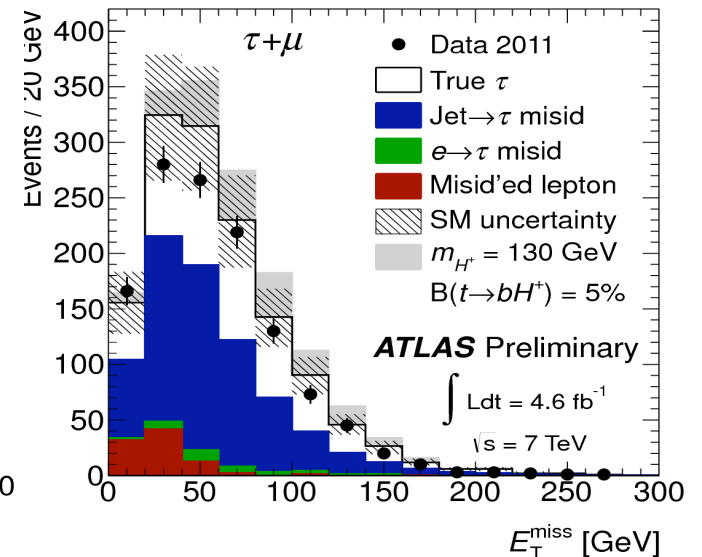
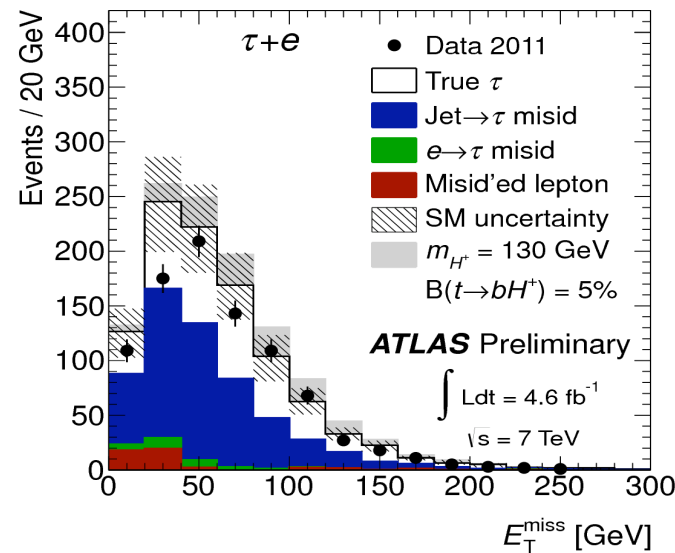

- Background contributions with **misidentified taus**:
 μ : 0.05%, e : 1%, jets: 55% ; jet $\rightarrow \tau_{had}$ mis-ID measured with W+jets
- True-tau background taken from simulation

A candidate event in $\tau_{had} + \text{lepton}$ channel

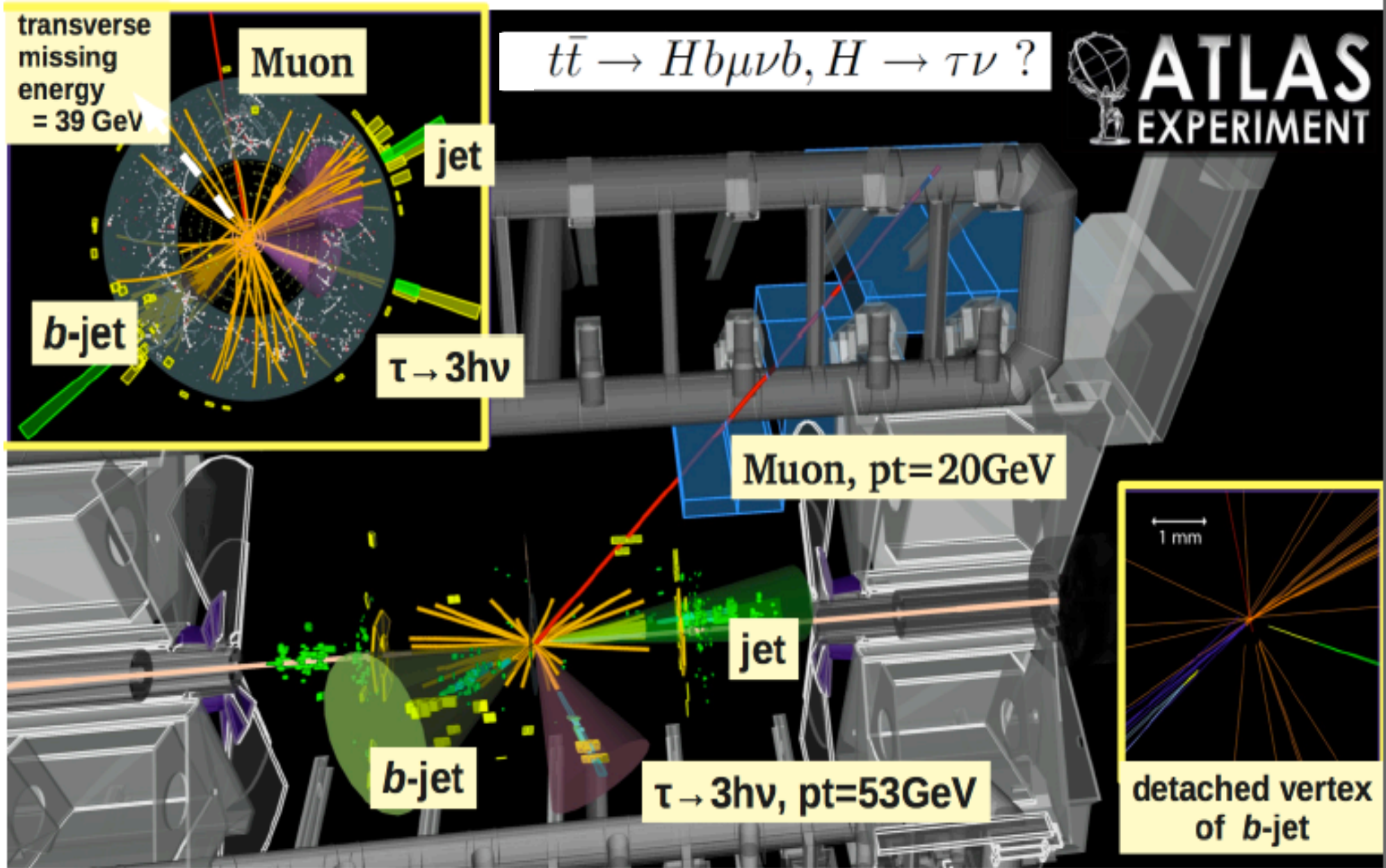

Charged Higgs: $\tau_{\text{had}} + \text{jets}$ channel

Selection:

- $\tau + E_T^{\text{miss}}$ trigger
- **1 τ_{had}** with $p_T > 40$ GeV
- ≥ 4 jets (≥ 1 **b-tagged**) with $p_T > 20$ GeV
- $E_T^{\text{miss}} > 65$ GeV
- E_T^{miss} significance: $\frac{E_T^{\text{miss}}}{0.5 \cdot \sqrt{\sum p_T}} > 13 \text{ GeV}^{1/2}$
- jjb combination (highest p_T) consistent m_{top}

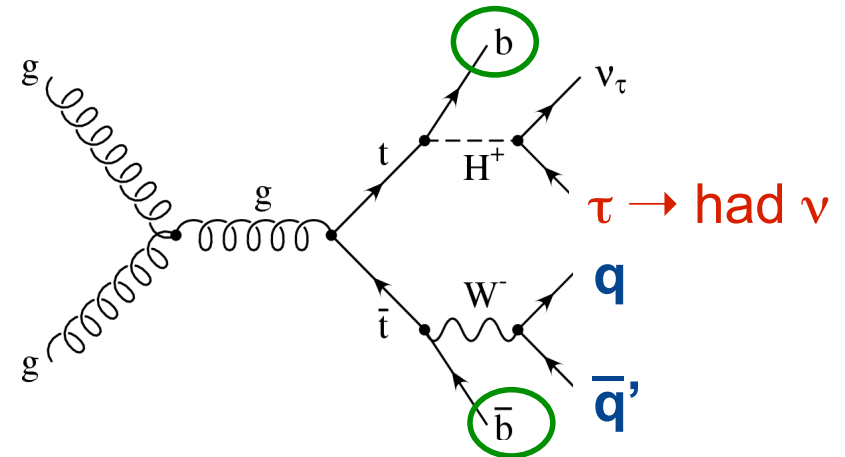

Discriminating variable:

$$m_T = \sqrt{2p_T^\tau E_T^{\text{miss}} (1 - \cos \phi_{\tau, \text{miss}})}$$

- **True-tau background** estimated with τ embedding in $\mu + \text{jets}$ events (with top-pair like event topology)
- Mis-id. tau background: as for $\tau_{\text{had}} + \text{lepton}$

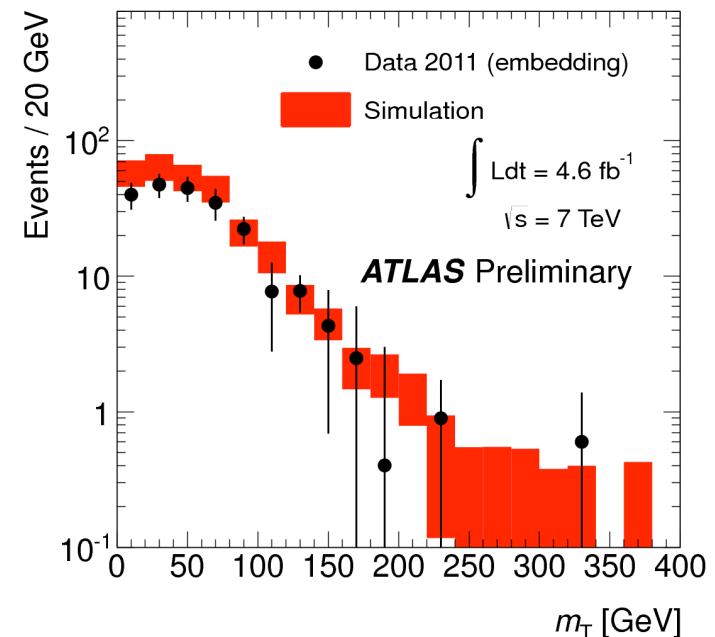

Charged Higgs: $\tau_{had} + jets$ channel

Sample	Event yield ($\tau+jets$)
True τ (embedding method)	$210 \pm 10 \pm 44$
Misidentified jet $\rightarrow \tau$	$36 \pm 6 \pm 10$
Misidentified $e \rightarrow \tau$	$3 \pm 1 \pm 1$
Multi-jet processes	$74 \pm 3 \pm 47$
Σ SM	$330 \pm 12 \pm 65$
Data	355
$t \rightarrow bH^+$ (130 GeV)	$220 \pm 6 \pm 56$

Multijet background estimated by fitting E_T^{miss} shapes to data.

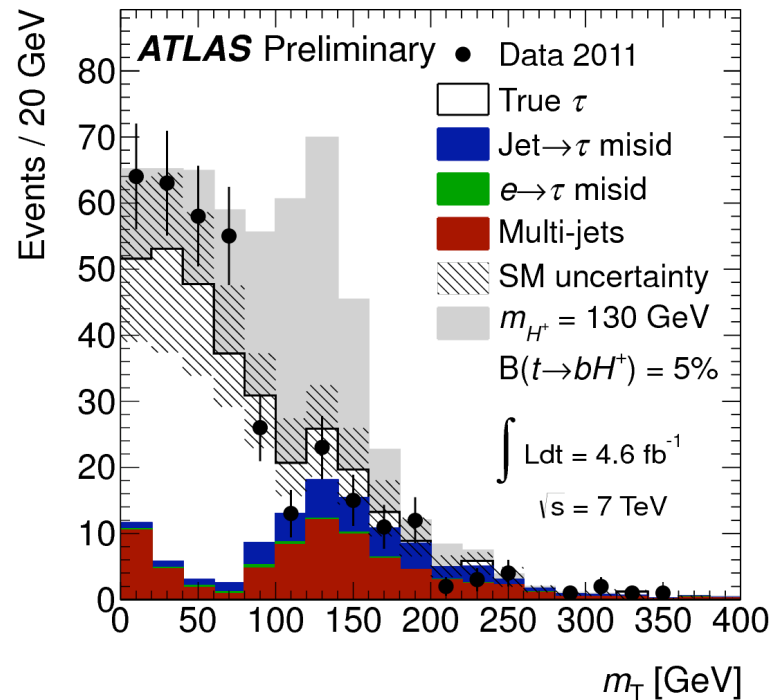
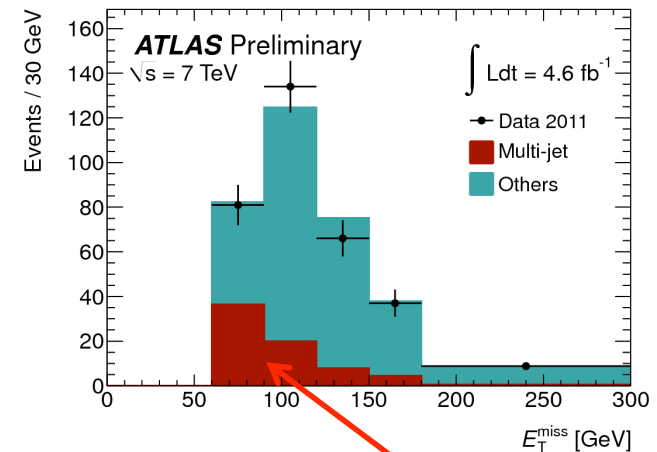

Multijet shape from control sample with inverted τ and b ID

Charged Higgs: Exclusion limits

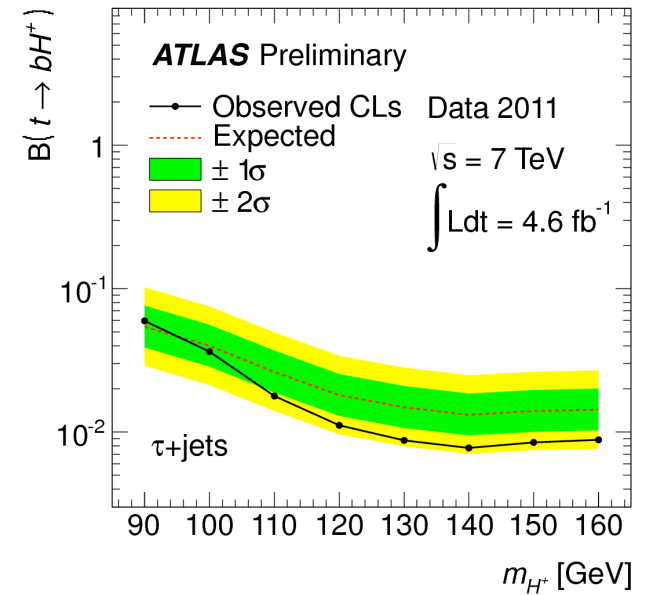
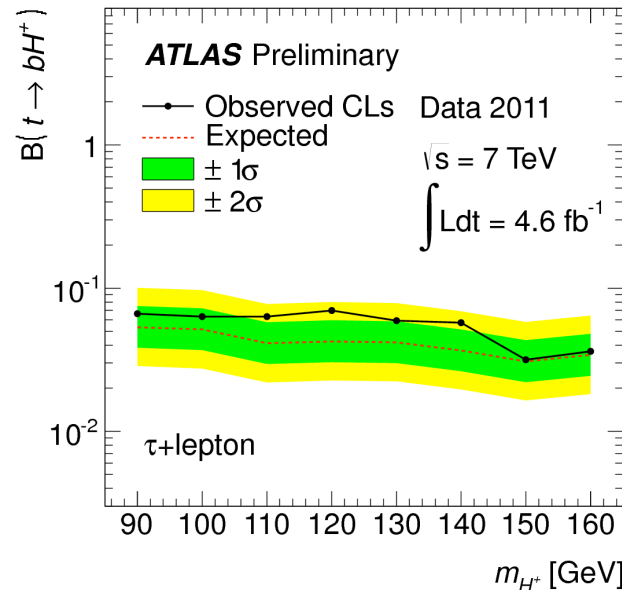
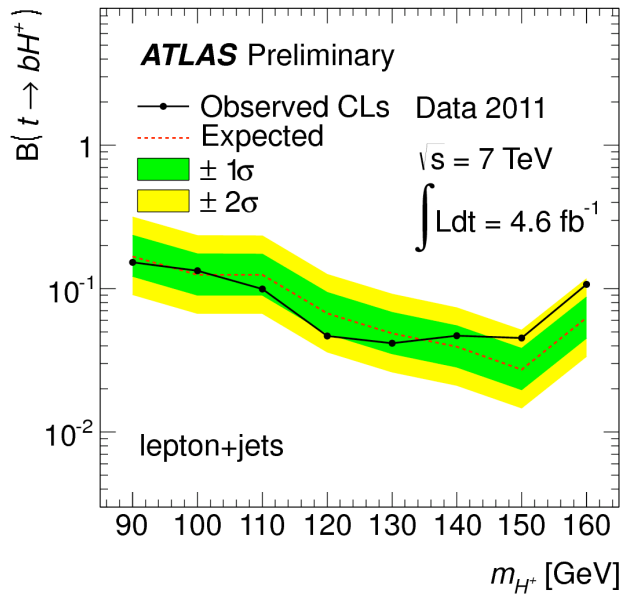

ATLAS-CONF-2012-011

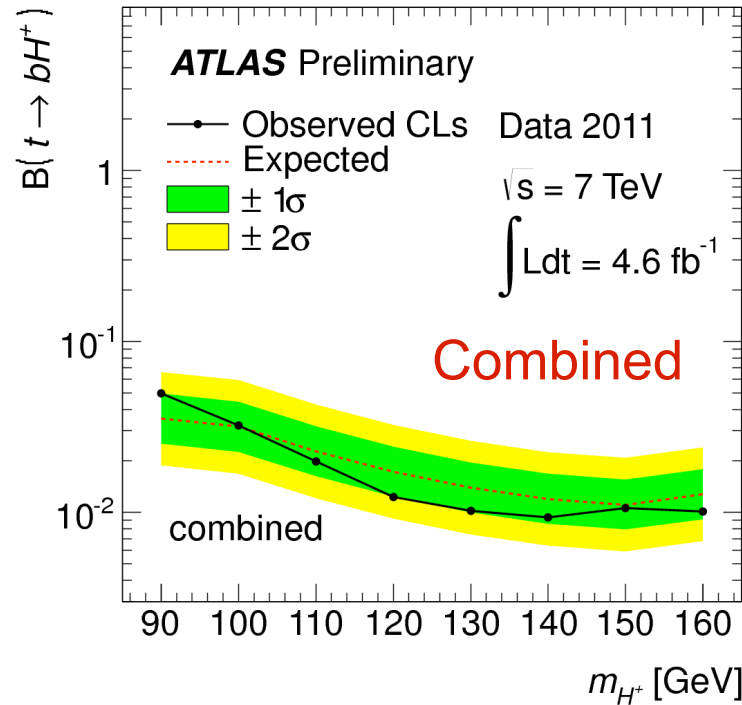

Tevatron limits:
BR < 10-15%

Charged Higgs: Exclusion limits (MSSM)

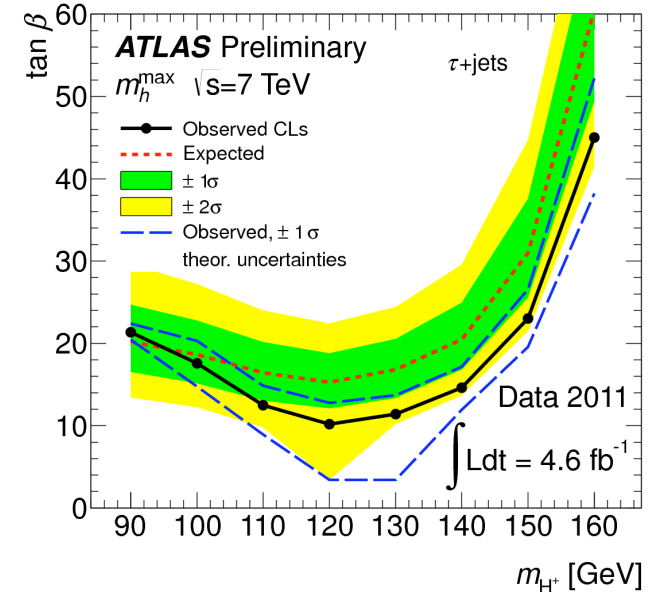
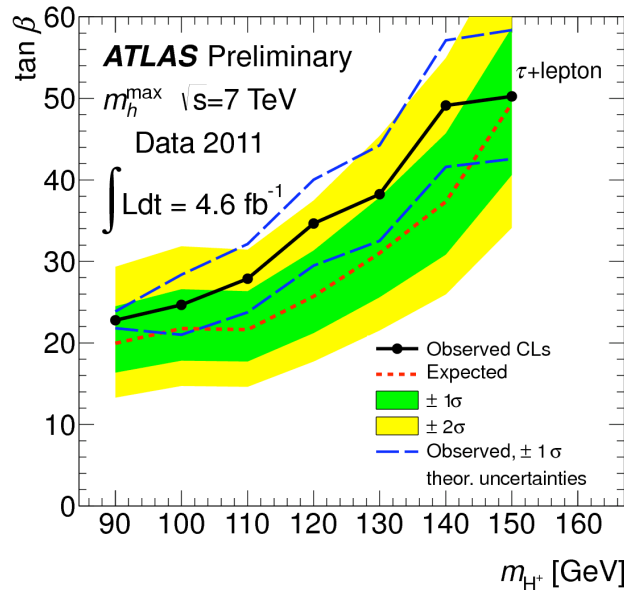
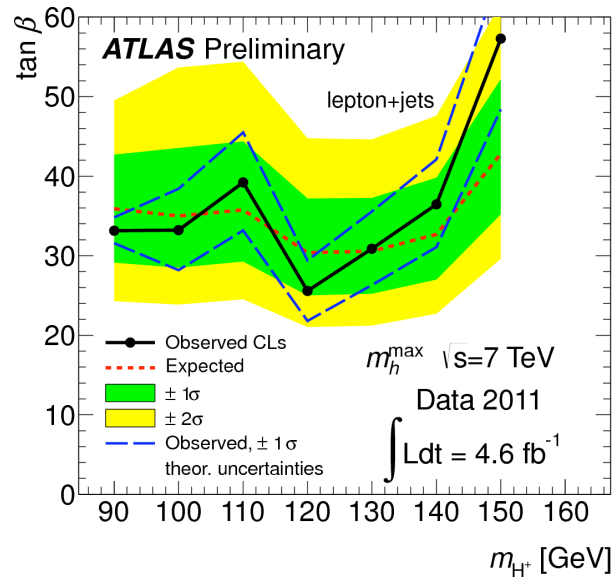

ATLAS-CONF-2012-011

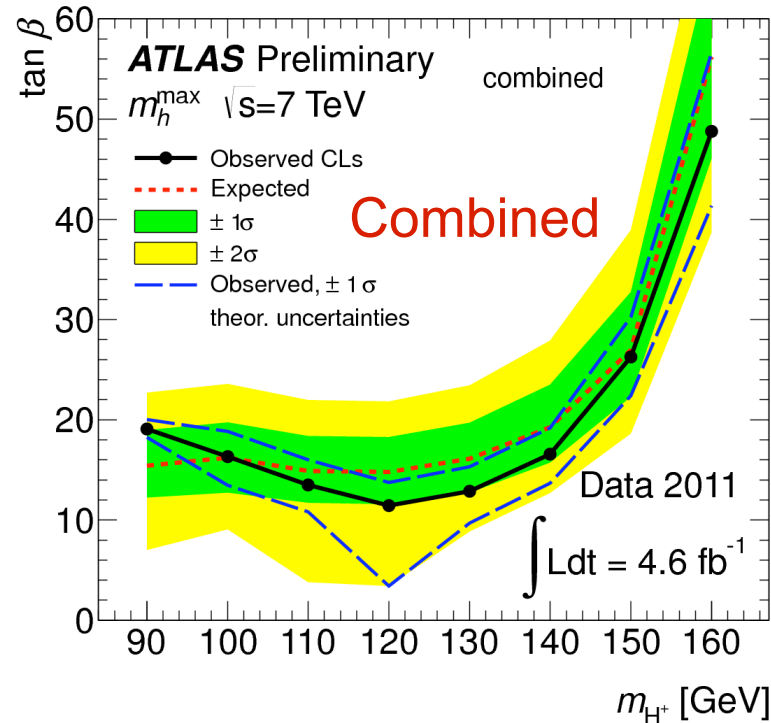

...we will probably be able to rule out low-mass charged Higgs with 2012 data, if it doesn't exist!

Charged Higgs: $H^+ \rightarrow c\bar{s}$

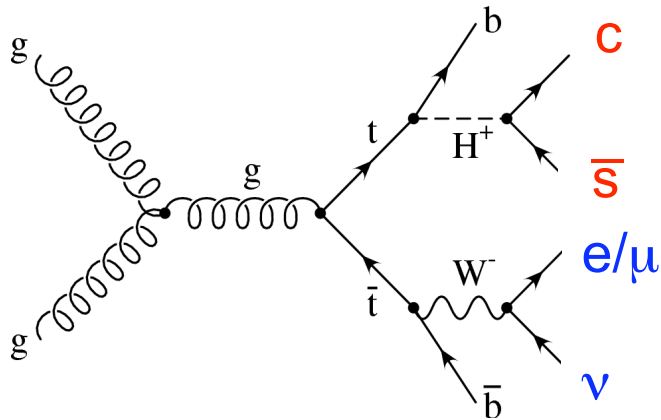

- $H \rightarrow c\bar{s}$ dominates for $\tan\beta < 1$
- Require **large E_T^{miss}** and m_T to suppress multijet background
- **Kinematic fit with W and top mass constraints** to find best H^+ candidate
- Set limits on $\text{BR}(t \rightarrow H^+b)$ assuming $\text{BR}(H^+ \rightarrow c\bar{s}) = 100\%$

ATLAS-CONF-2011-094

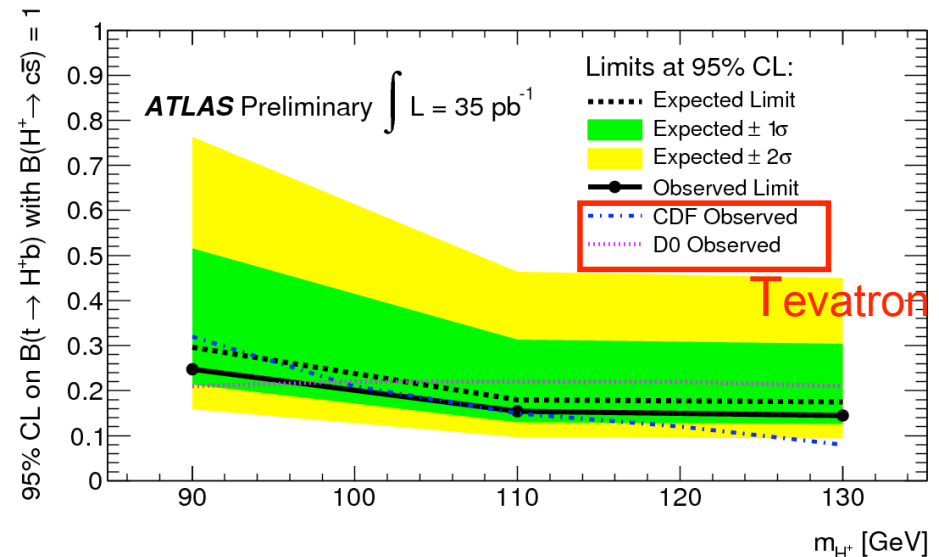
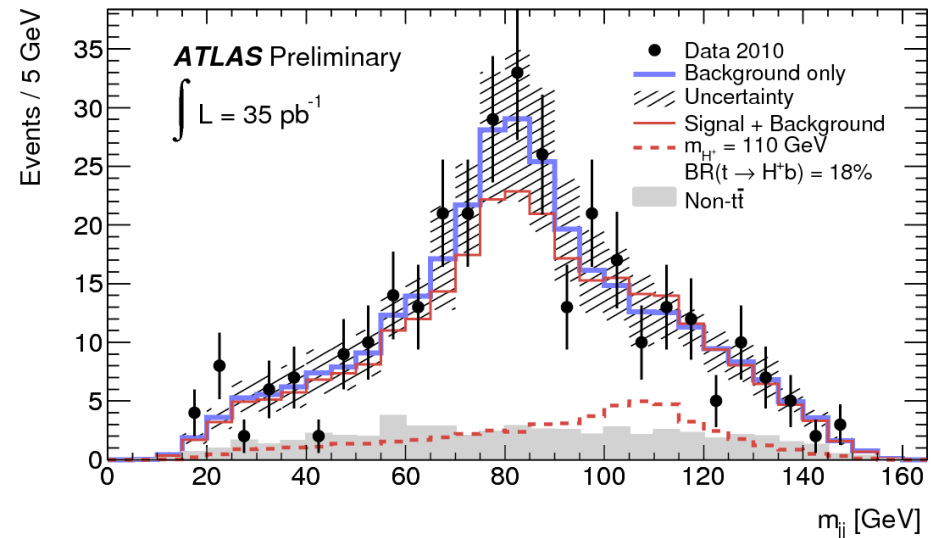

Doubly-charged Higgs

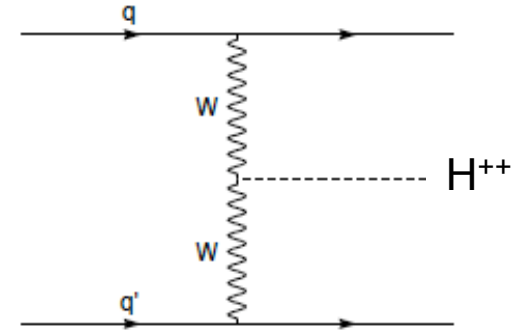
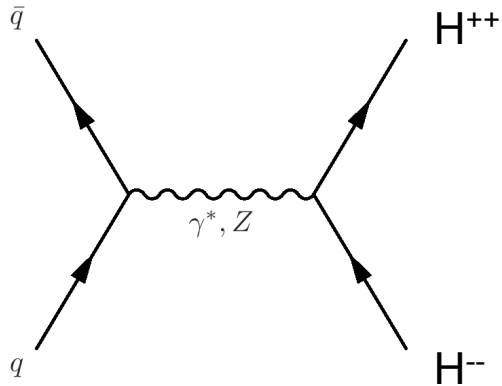

- Relevant e.g. in **Higgs triplet**, **Little Higgs** and **Left-Right Symmetric** models
- Select μ pairs with **same-sign charges** and $p_T > 20$ GeV
- Look for **resonance in $\mu^\pm\mu^\pm$ mass spectrum**
- **No significant excess** over SM background found

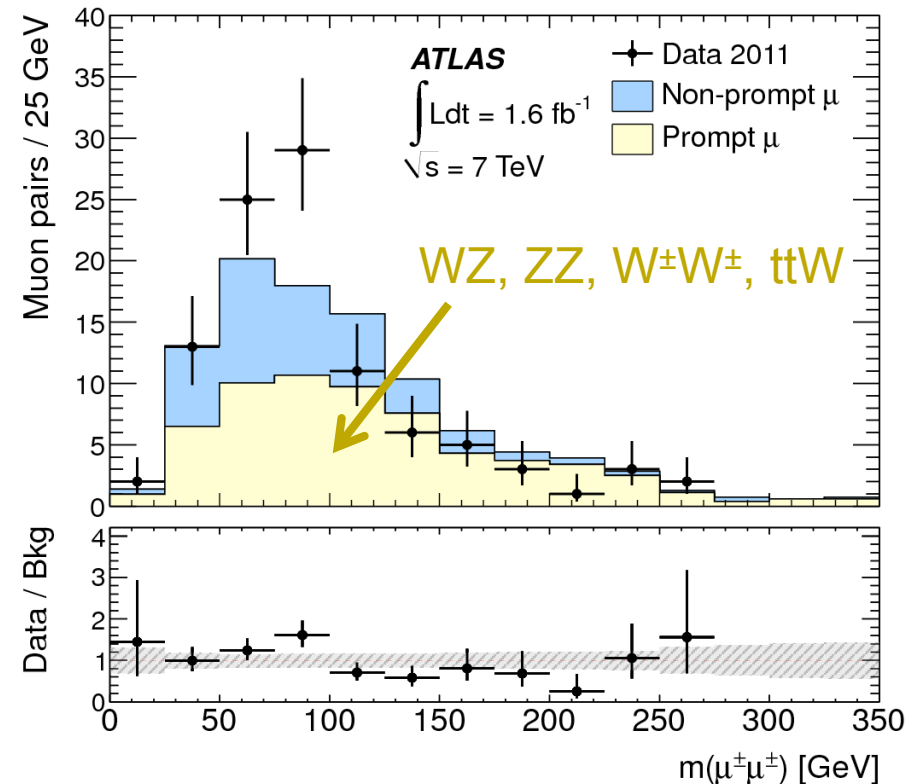

Doubly-charged Higgs: Exclusion limits

Set limits on $H^{++} H^{-}$ pair production via Drell Yan process $pp \rightarrow Z/\gamma^* \rightarrow H^{++} H^{-}$

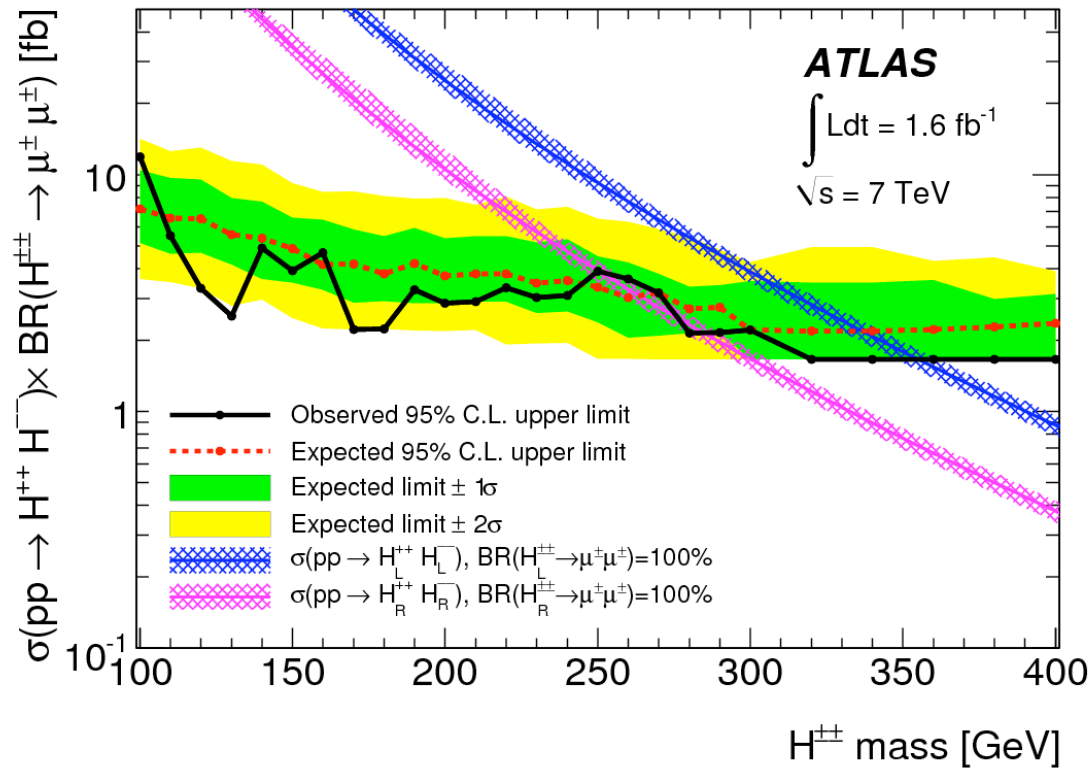

Right-handed Higgs mass < 251 GeV
 Left -handed Higgs mass < 355 GeV
 @95% CL if $Br(H^{++} \rightarrow \mu^+ \mu^+) = 100\%$

Tevatron (CDF) upper limit: 205-245 GeV

Assuming predicted cross section, set limits on BR

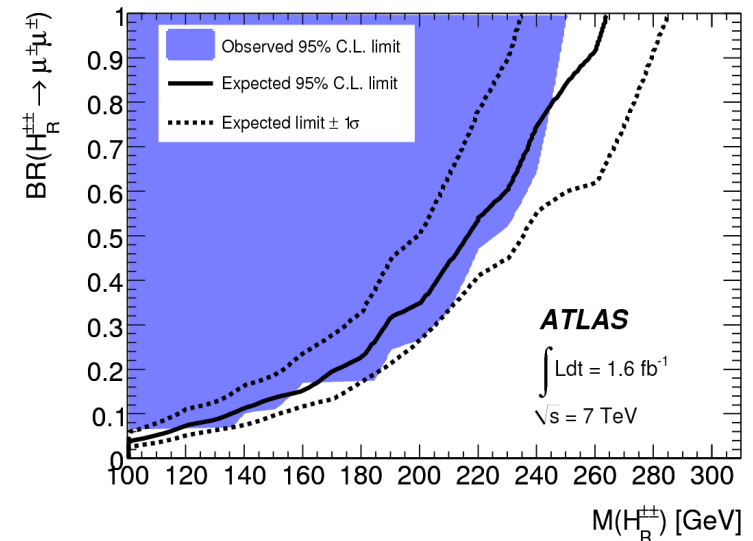
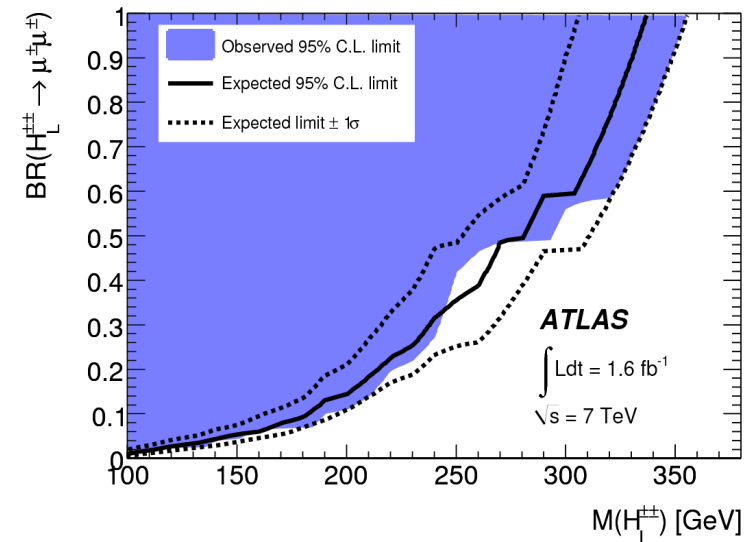

NMSSM $a_1 \rightarrow \mu^+\mu^-$

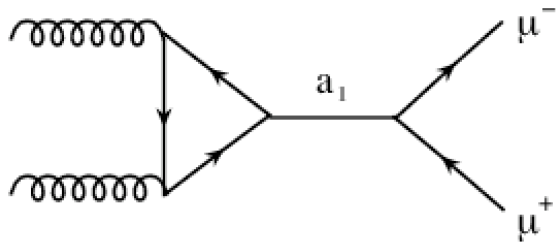

- **NMSSM**: introduces **singlet scalar field** to solve μ problem
 \Rightarrow 3 CP-even scalars (h_1, h_2, h_3)
 2 CP-odd scalars (a_1, a_2)
- a_1 can be **very light!**
 $m_{a_1} < 2 m_B$

Analysis:

- Opposite-sign **di-muons** ($P_T > 4 \text{ GeV}$)
- Likelihood ratio selection based on $\mu^+\mu^-$ **vertex χ^2** and μ **isolation**
- Set limits by **fitting to mass spectrum**
- Y region excluded

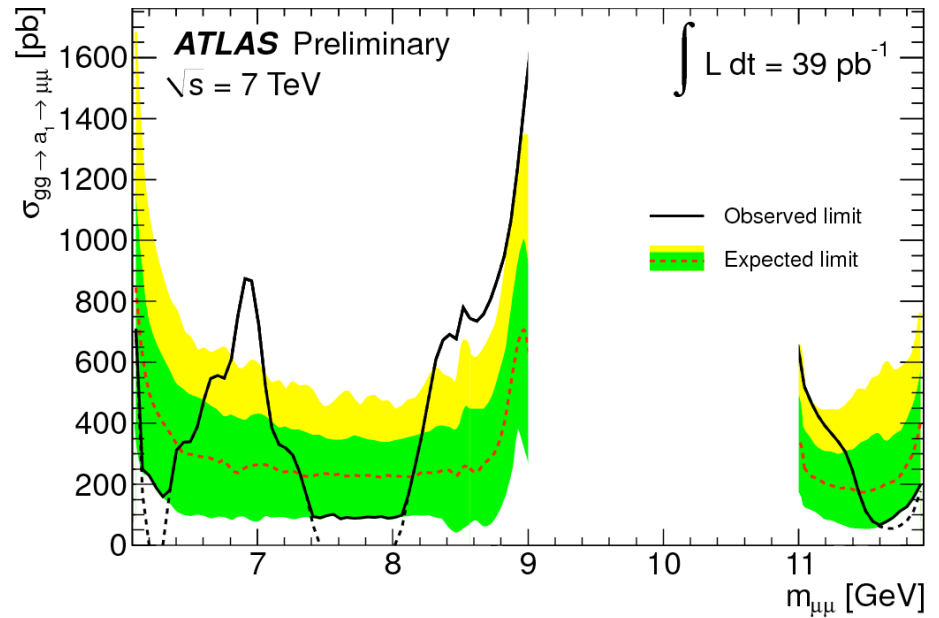
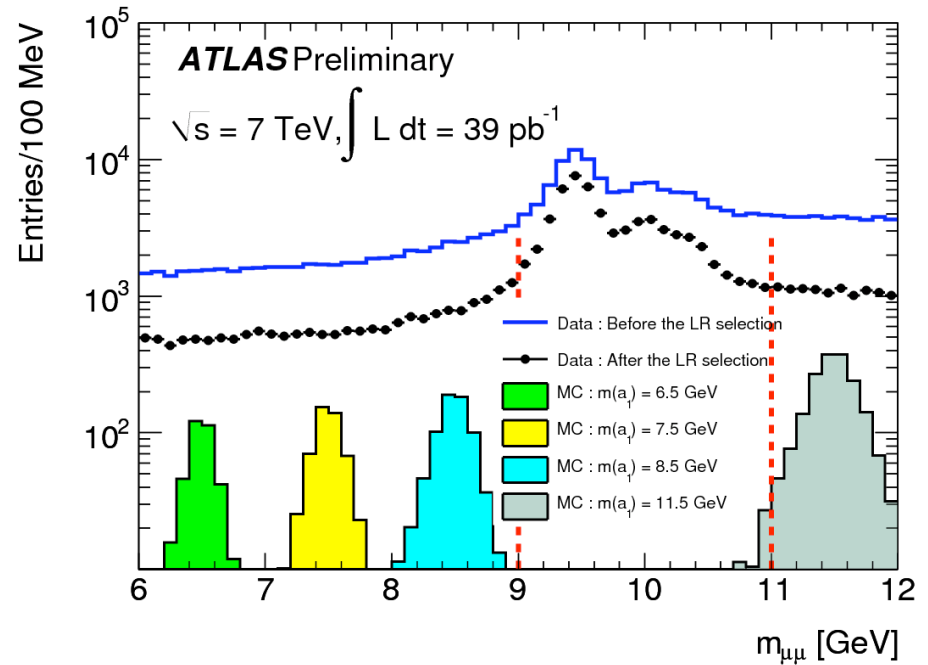

Conclusions

- Various interesting BSM Higgs scenarios are being probed in parallel to SM Higgs search
- No indication for BSM Higgs bosons yet ...
but lots of upper limits on cross sections/branching ratios
- Searches continue with more data and improved methods
⇒ There is still significant room for BSM Higgs searches for the year ahead ... and after!

Backup Slides

Fermiophobic Higgs $\rightarrow \gamma\gamma$: Exclusion limits

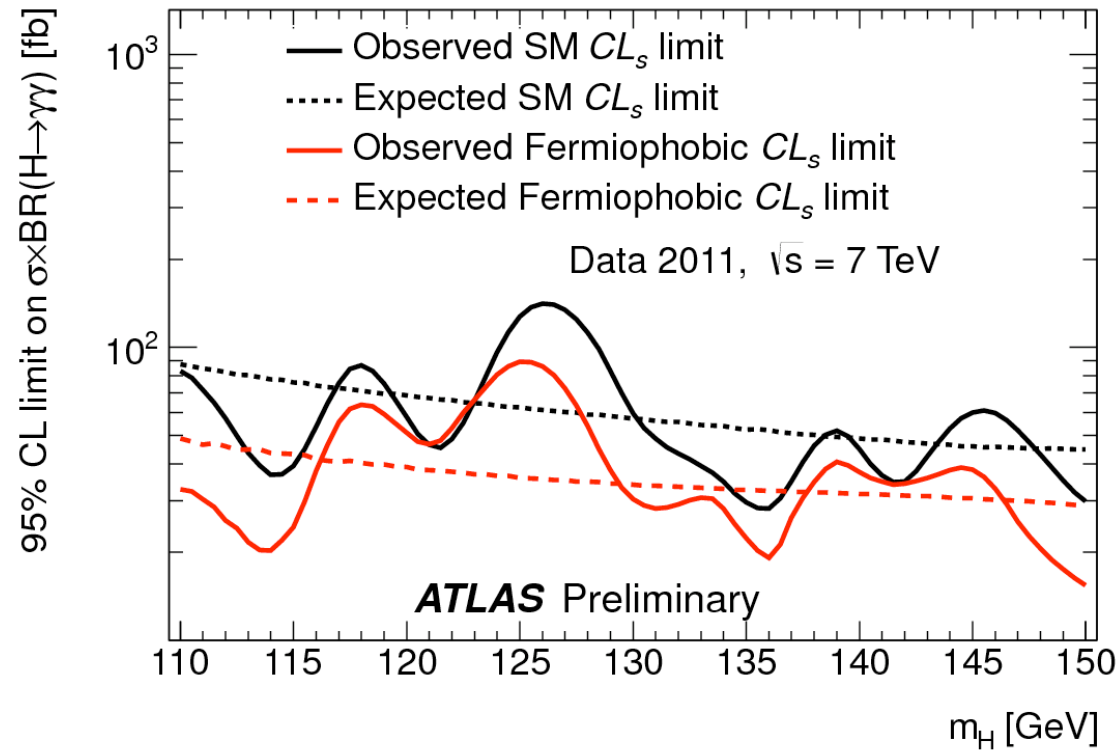

Fermiophobic Higgs $\rightarrow \gamma\gamma$: Systematics

Signal event yield	
Photon reconstruction and identification	$\pm 11\%$
Effect of pileup on photon identification	$\pm 4\%$
Isolation cut efficiency	$\pm 5\%$
Trigger efficiency	$\pm 1\%$
Higgs boson cross section	$\pm 9\%$
Luminosity	$\pm 3.9\%$
Signal mass resolution	
Calorimeter energy resolution	$\pm 12\%$
Photon energy calibration	$\pm 6\%$
Effect of pileup on energy resolution	$\pm 3\%$
Photon angular resolution	$\pm 1\%$
Signal category migration	
Higgs boson p_T modelling	$\pm 1\%$
Conversion rate	$\pm 4.5\%$
Background model	$\pm (0.1 - 7.9) \text{ events}$

MSSM Higgs sector

- MSSM: 2 Higgs doublets \Rightarrow 5 Higgs bosons:

h^0 (CP=1), H^0 (CP=1), A^0 (CP=-1), H^\pm

- At tree level described by two parameters: m_A , $\tan\beta = v_u/v_d$
- Fixed mass relations at tree level:

$$m_{H,h}^2 = \frac{1}{2} \left(m_A^2 + m_Z^2 \pm \sqrt{(m_A^2 + m_Z^2)^2 - 4m_Z^2 m_A^2 \cos^2 2\beta} \right)$$

$$m_h^2 \leq m_Z^2 \cos^2 2\beta \leq m_Z^2$$

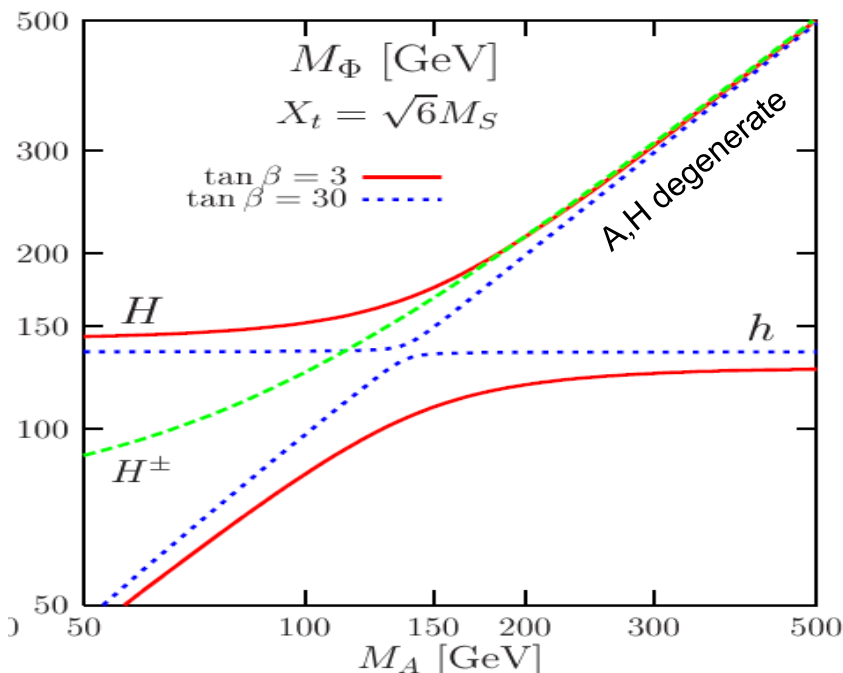

- Upper mass bound modified by radiative corrections (depend on SUSY parameters, e.g. mixing in stop sector)

All parameters except $\tan\beta$, m_A fixed in benchmark scenarios:

m_h^{\max} : $m_h < 133$ GeV, maximum allowed mass for h ←
 nomixing: $m_h < 116$ GeV, no mixing in stop sector
 gluphobic: $m_h < 119$ GeV, suppressed gg fusion
 small α : $m_h < 123$ GeV, suppressed $t\bar{t} h$, $h \rightarrow b\bar{b}$

MSSM Higgs production

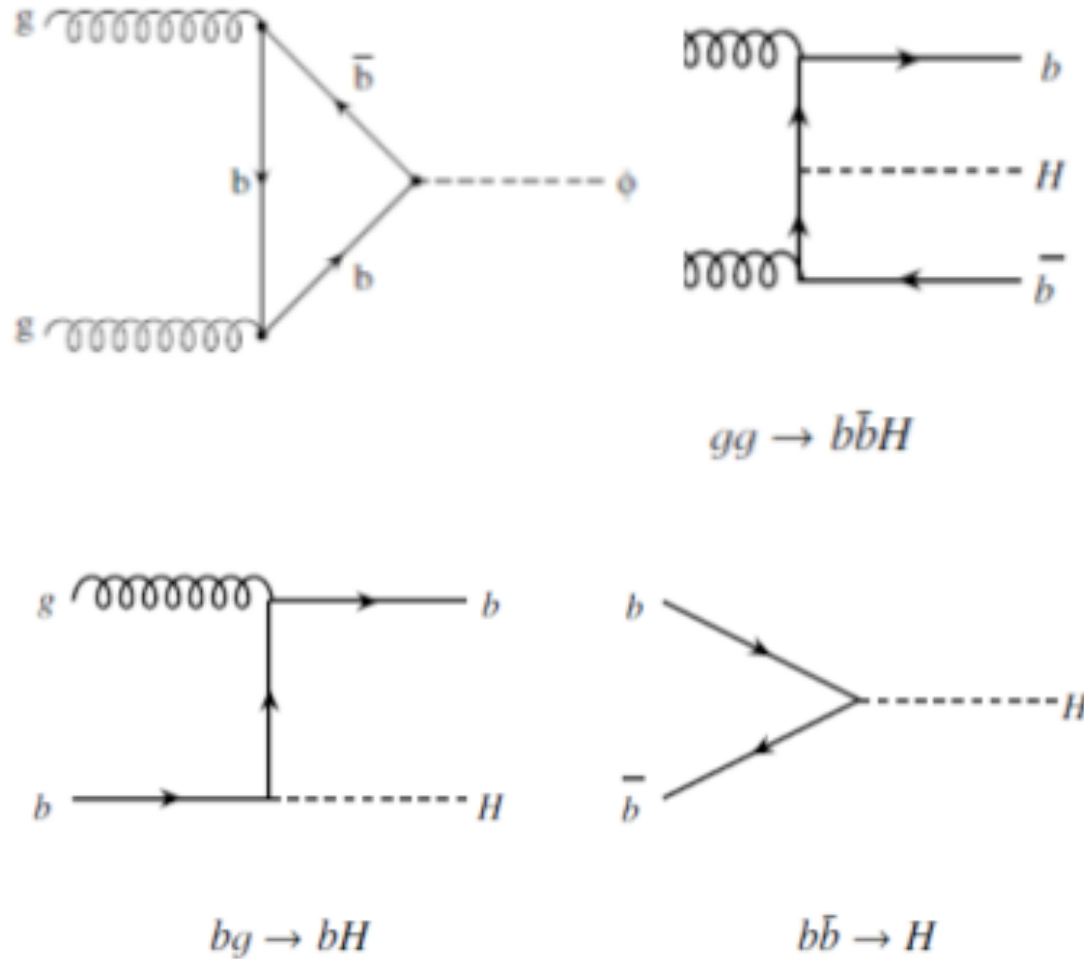

Estimation of $Z \rightarrow \tau \tau$ Background

- **Reliable $Z \rightarrow \tau \tau$ model** important for **low-mass Higgs**
- Desirable to use **real data**, but **cannot be selected signal-free**
- Instead, use **high-purity $Z \rightarrow \mu \mu$ sample** (\sim signal-free due to small Higgs- μ coupling)

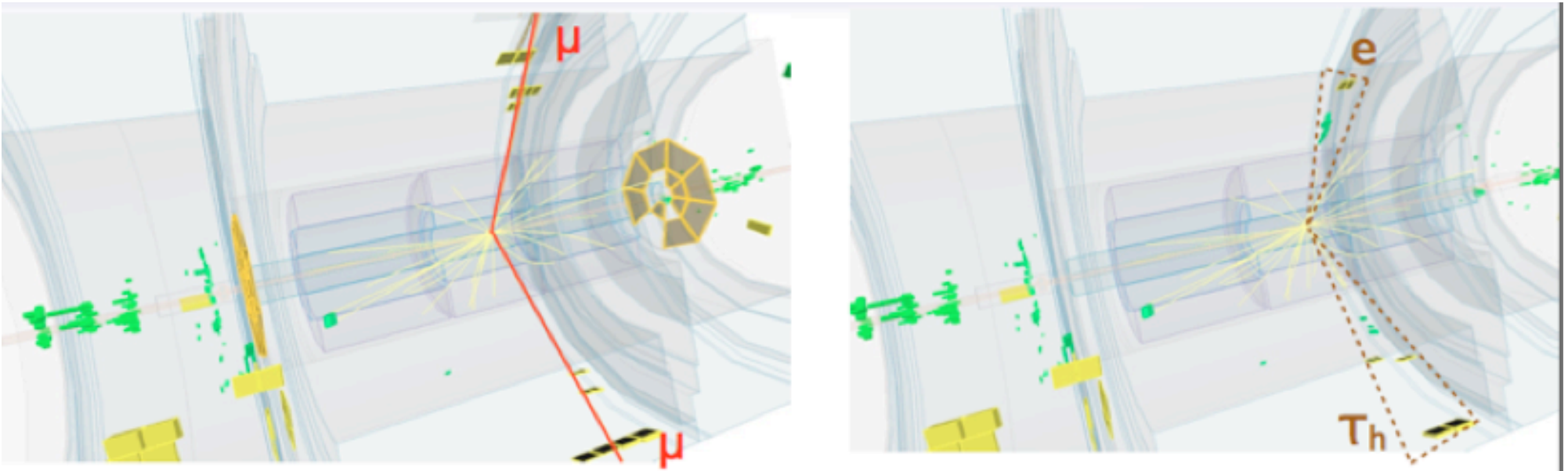

$Z \rightarrow \tau \tau$ "Embedding": Method

- In $Z \rightarrow \mu \mu$ events, **remove muon tracks** and nearby calorimeter cells
- **Simulate stand-alone $Z \rightarrow \tau \tau$ decays** with same 4-momenta for the τ 's as for the muons (after mass correction)
- **Merge** into single hybrid event and re-reconstruct objects and E_{τ}^{miss}

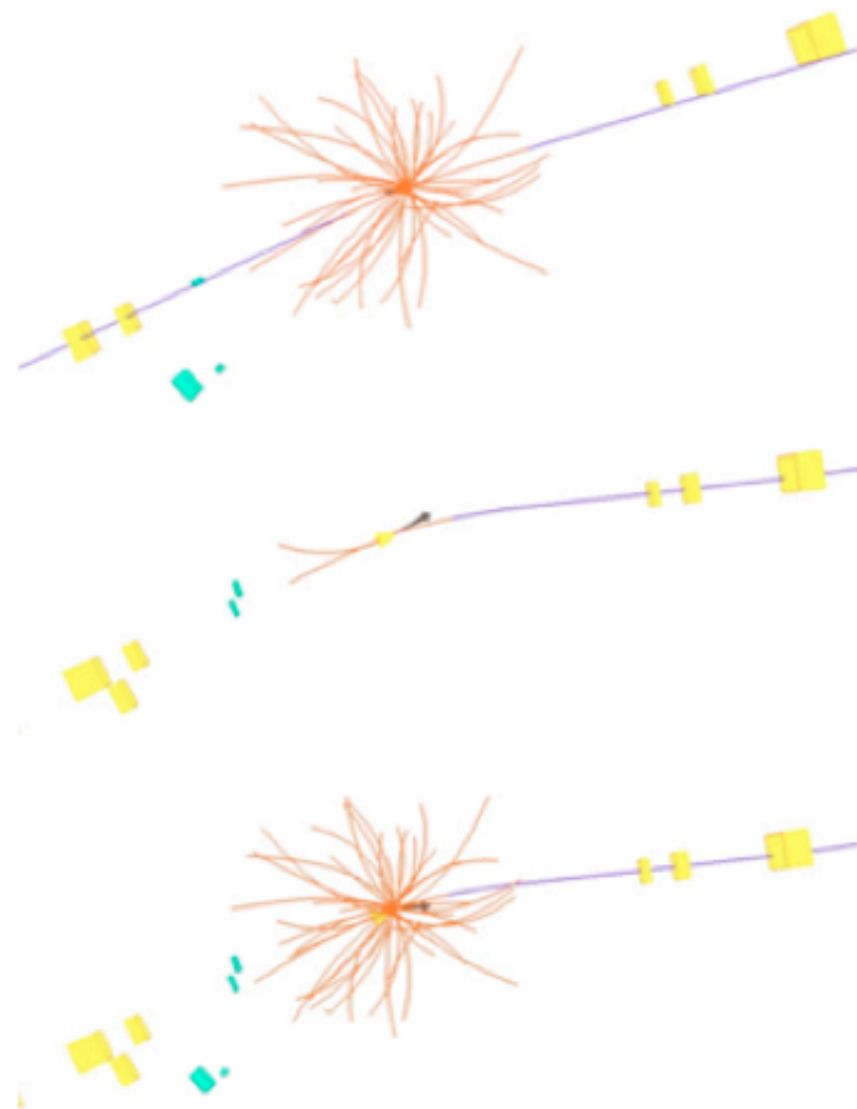

Neutral MSSM Higgs: Background Estimation

- Estimate background from **same-sign (SS)** data sample

$$n_{OS}^{Bkg} = n_{SS}^{Bkg} + n_{OS-SS}^{QCD} + n_{OS-SS}^W + n_{OS-SS}^Z + n_{OS-SS}^{other}$$
$$\approx n_{SS}^{Bkg} + n_{OS-SS}^W + n_{OS-SS}^Z + n_{OS-SS}^{other}$$

- Assumption made for QCD:

$$r_{QCD} = n(OS)/n(SS) \approx 1$$

Checked with QCD-enhanced sample

- $E_T^{miss} < 15$ GeV
- loosened lepton isolation

$$r_{QCD} = 1.16 \pm 0.04^{stat} \pm 0.09^{syst}$$
$$r_{QCD}^{MC} = 1.06 \pm 0.13^{stat}$$

Neutral MSSM Higgs: Background Estimation

$$n_{OS}^{Bkg} \approx n_{SS}^{Bkg} + n_{OS-SS}^W + n_{OS-SS}^Z + n_{OS-SS}^{other}$$

OS-SS “add-on”
due to $r_{OS/SS} \neq 1$

- n_{SS} from nominal selection with $Q(\ell) \cdot Q(\tau) = +1$
- $Z \rightarrow \tau^+ \tau^-$ and other background OS-SS “add-on” from simulation
- W +jets OS-SS “add-on”: from $M_T > 50$ GeV control sample

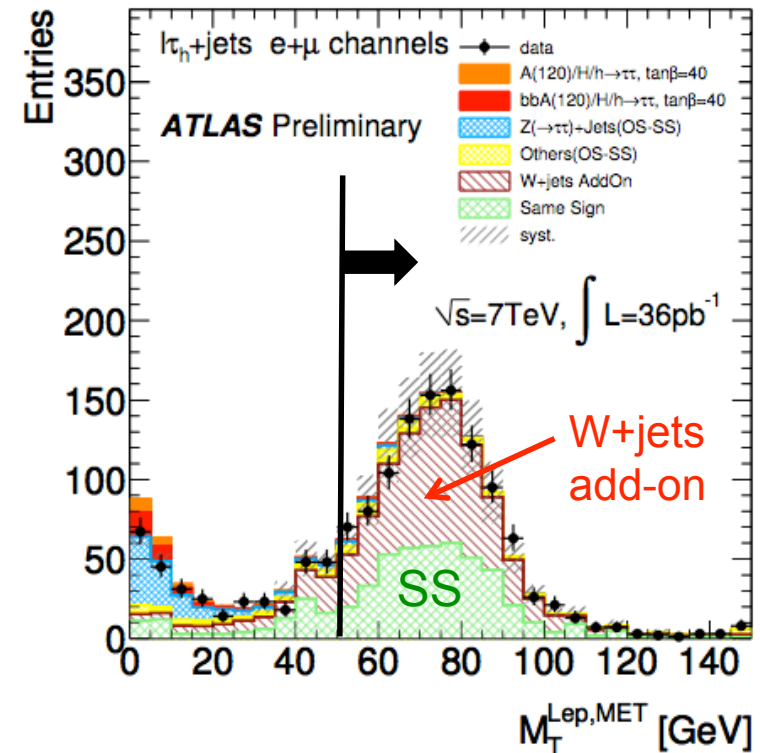

Neutral MSSM Higgs: Systematics

Table 4: Uncertainties on the number of selected events for those background contributions that are at least partially estimated from simulation and for a hypothetical signal ($m_A = 120$ GeV and $\tan\beta = 20$ for the $e\mu$ and $\ell\tau_{had}$ final states and $m_A = 200$ GeV and $\tan\beta = 20$ for the $\tau_{had}\tau_{had}$ final state). All numbers are given in %. When three numbers are given the first refers to the $e\mu$ final state, the second to the $\ell\tau_{had}$ final states and the third to the $\tau_{had}\tau_{had}$ final state. If an uncertainty does not apply for a certain background, this is indicated by a “-”. For the $e\mu$ final state, the uncertainty on the W +jets background is dominated by the statistical component and the systematic uncertainty is neglected; for the $\ell\tau_{had}$ final state the W +jets background is estimated from data.

	W+jets	Di-boson	$t\bar{t}$ + single-top	$Z/\gamma^* \rightarrow$ $ee, \mu\mu$	$Z/\gamma^* \rightarrow$ $\tau^+\tau^-$	Signal
$\sigma_{inclusive}$	-/-/5	7	10	5/5/-	5	14/14/16
Acceptance	-/-/20	4/2/7	3/2/9	2/14/-	5/14/14	5/7/9
e efficiency	-/-/0.8	4/3.1/0.5	4/3.6/0.3	4/3.1/-	4/3.0/0.5	4/3.6/0.1
μ efficiency	-/-/0.3	2/1.2/0.4	2/1.1/0.0	2/1.3/-	2/1.8/0.4	2/1.0/0.1
τ efficiency and fake rate	-/-/21	-/9.1/15	-/9.1/13	-/48/-	-/9.1/15	-/9.1/15
Energy scales and resolution	-/+ ³⁴ / ₋₂₁	2/+ ¹⁹ / ₋₉ / + ²⁶ / ₋₁₂	6/+ ⁵ / ₋₄ / 12	1/+ ³⁹ / ₋₂₅ / -	1/11/+ ⁶³ / ₋₂₃	1/+ ³⁰ / ₋₂₃ / + ⁹ / ₋₈
Luminosity	-/-/3.7	3.7	3.7	3.7/3.7/-	3.7	3.7
Total uncertainty	-/+ ⁴⁵ / ₋₃₆	10/+ ²³ / ₋₁₆ / + ³² / ₋₂₂	13/15/23	8/+ ⁶⁴ / ₋₅₆ / -	9/21/+ ⁶⁷ / ₋₃₁	16/+ ³⁵ / ₋₃₀ / + ²⁶ / ₋₂₅

H⁺: Estimation of mis-ID lepton background

Misidentified-lepton background determined from samples with **tight (T)** and **loose (L)** lepton ID:

$$\begin{aligned}N^L &= N_m^L + N_r^L \\N^T &= N_m^T + N_r^T\end{aligned}$$

$$N_m^T = \frac{p_m}{p_r - p_m} (p_r N^L - N^T)$$

with $p_r = \frac{N_r^T}{N_r^L}$ and $p_m = \frac{N_m^T}{N_m^L}$
from $Z \rightarrow e^+e^-$ from multi-jets

Charged Higgs: Systematics

Source of uncertainty	Normalisation uncertainty
lepton+jets:	
Generator and parton shower ($b\bar{b}WH^+$, signal region)	10%
Generator and parton shower ($b\bar{b}W^+W^-$, signal region)	8%
Generator and parton shower ($b\bar{b}WH^+$, control region)	7%
Generator and parton shower ($b\bar{b}W^+W^-$, control region)	6%
Initial and final state radiation (signal region)	8%
Initial and final state radiation (control region)	13%
τ+lepton:	
Generator and parton shower ($b\bar{b}WH^+$)	2%
Generator and parton shower ($b\bar{b}W^+W^-$)	5%
Initial and final state radiation	13%
τ+jets:	
Generator and parton shower ($b\bar{b}WH^+$)	5%
Generator and parton shower ($b\bar{b}W^+W^-$)	5%
Initial and final state radiation	19%

Charged Higgs: Systematics

Source of uncertainty	Normalisation uncertainty	Shape uncertainty
lepton+jets: lepton misidentification		
Choice of control region	6%	-
Z mass window	4%	-
Jet energy scale	16%	-
Jet energy resolution	7%	-
Sample composition	31%	-
τ +lepton: jet \rightarrow τ misidentification		
Statistics in control region	2%	-
Jet composition	11%	-
Object-related systematics	23%	3%
τ +lepton: e \rightarrow τ misidentification		
Misidentification probability	20%	-
τ +lepton: lepton misidentification		
Choice of control region	4%	-
Z mass window	5%	-
Jet energy scale	14%	-
Jet energy resolution	4%	-
Sample composition	39%	-
τ +jets: true τ		
Embedding parameters	6%	3%
Muon isolation	7%	2%
Parameters in normalisation	16%	-
τ identification	5%	-
τ energy scale	6%	1%
τ +jets: jet \rightarrow τ misidentification		
Statistics in control region	2%	-
Jet composition	12%	-
Purity in control region	6%	1%
Object-related systematics	21%	2%
τ +jets: e \rightarrow τ misidentification		
Misidentification probability	22%	-
τ +jets: multi-jet estimate		
Fit-related uncertainties	32%	-
E_T^{miss} -shape in control region	16%	-

Doubly-Charged Higgs: Event yields

Sample	Number of muon pairs with $m(\mu^\pm\mu^\pm)$			
	> 15 GeV	> 100 GeV	> 200 GeV	> 300 GeV
prompt muons	63.1 ± 7.8	34.9 ± 4.5	9.6 ± 1.6	2.24 ± 0.54
non-prompt muons	$37.5^{+10.3}_{-12.4}$	13.0 ± 4.5	1.8 ± 0.7	0.31 ± 0.18
charge flip	$0^{+2.7}_{-0.0}$	$0^{+0.9}_{-0.0}$	$0^{+0.7}_{-0.0}$	$0^{+0.61}_{-0.00}$
total	$100.6^{+13.2}_{-14.7}$	48.0 ± 6.4	$11.4^{+1.8}_{-1.7}$	$2.56^{+0.83}_{-0.57}$
data	101	32	7	1

Sample	Number of muon pairs with $m(\mu^+\mu^+)$			
	> 15 GeV	> 100 GeV	> 200 GeV	> 300 GeV
prompt muons	41.2 ± 5.3	23.5 ± 3.2	6.6 ± 1.2	1.33 ± 0.40
non-prompt muons	$20.2^{+5.9}_{-6.9}$	6.3 ± 2.2	1.0 ± 0.4	0.24 ± 0.15
charge flip	$0^{+1.3}_{-0.0}$	$0^{+0.5}_{-0.0}$	$0^{+0.3}_{-0.0}$	$0^{+0.30}_{-0.00}$
total	$61.4^{+8.0}_{-8.7}$	29.8 ± 3.9	7.5 ± 1.3	$1.57^{+0.52}_{-0.42}$
data	61	22	6	1

Sample	Number of muon pairs with $m(\mu^-\mu^-)$			
	> 15 GeV	> 100 GeV	> 200 GeV	> 300 GeV
prompt muons	21.9 ± 3.0	11.4 ± 1.8	3.04 ± 0.67	0.91 ± 0.32
non-prompt muons	$17.4^{+4.7}_{-5.8}$	6.8 ± 2.4	0.83 ± 0.38	$0.07^{+0.08}_{-0.07}$
charge flip	$0^{+1.3}_{-0.0}$	$0^{+0.5}_{-0.0}$	$0^{+0.34}_{-0.0}$	$0^{+0.30}_{-0.00}$
total	$39.3^{+5.8}_{-6.5}$	18.2 ± 3.0	$3.87^{+0.84}_{-0.77}$	$0.98^{+0.45}_{-0.33}$
data	40	10	1	0

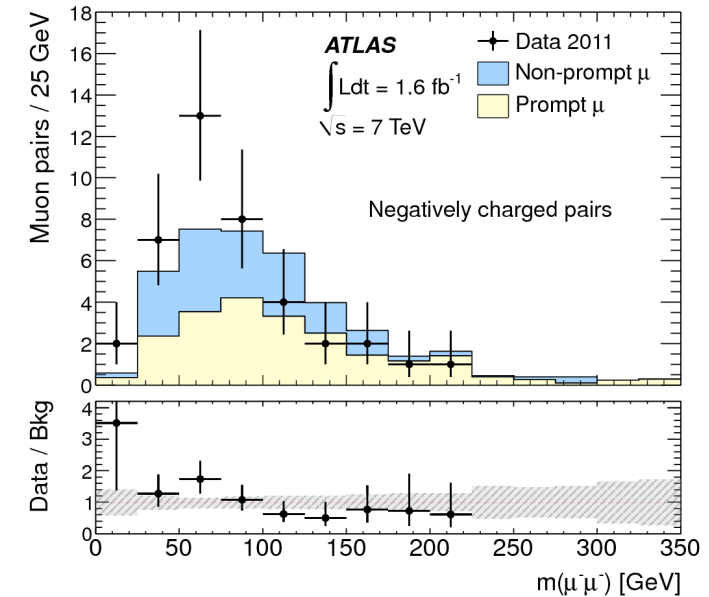
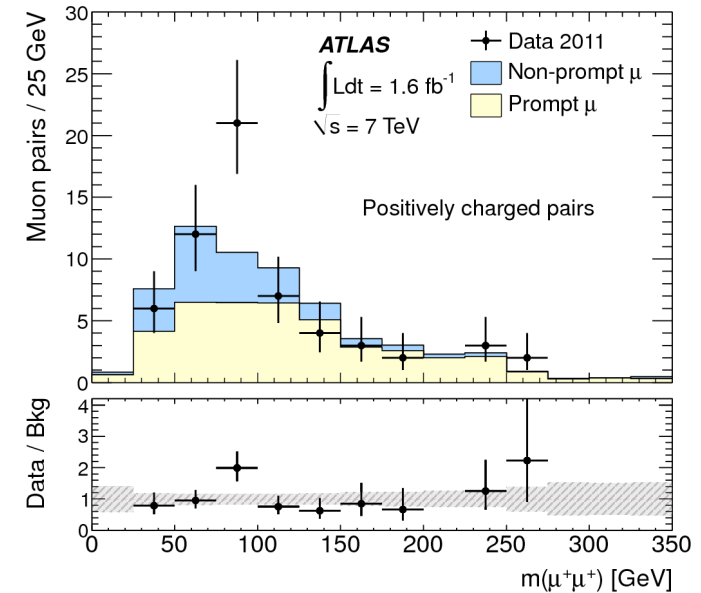

NMSSM $a_1 \rightarrow \mu^+\mu^-$: Additional Plots

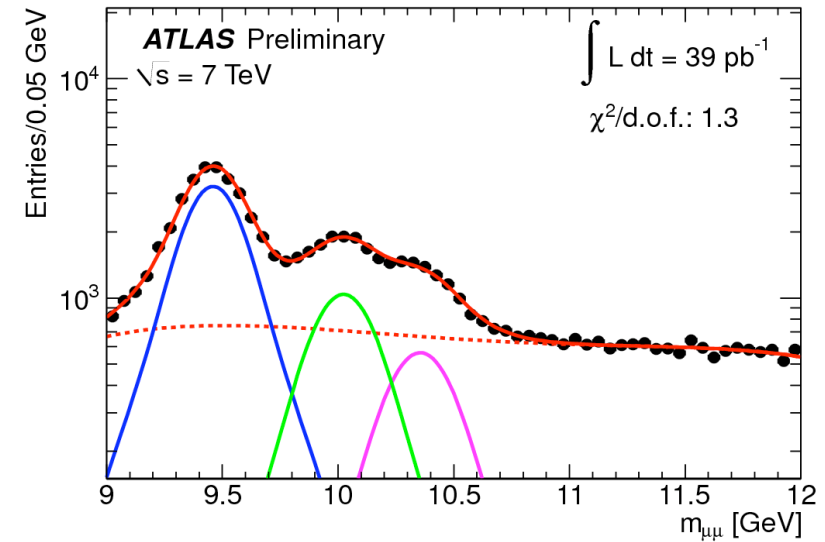
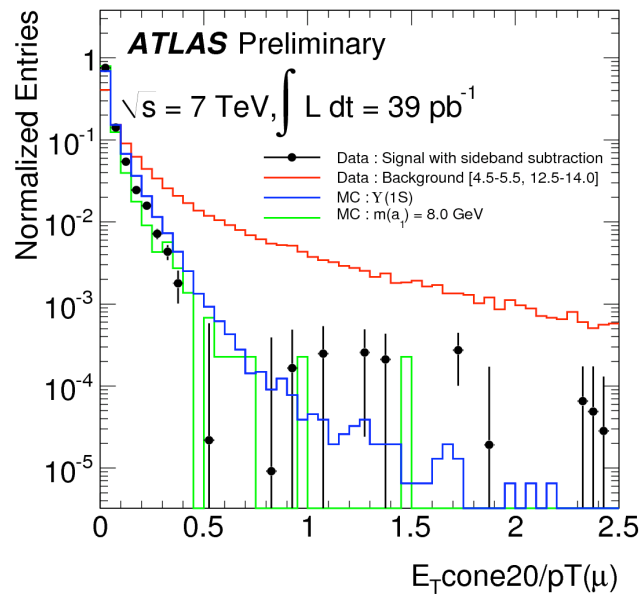
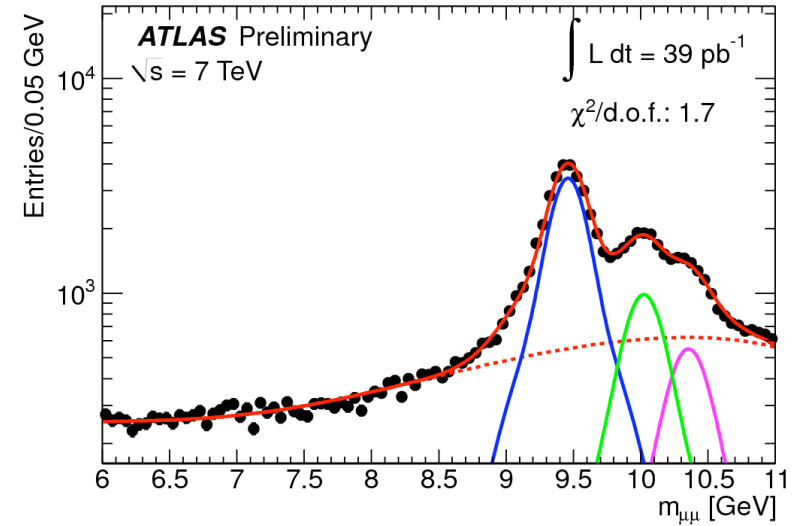
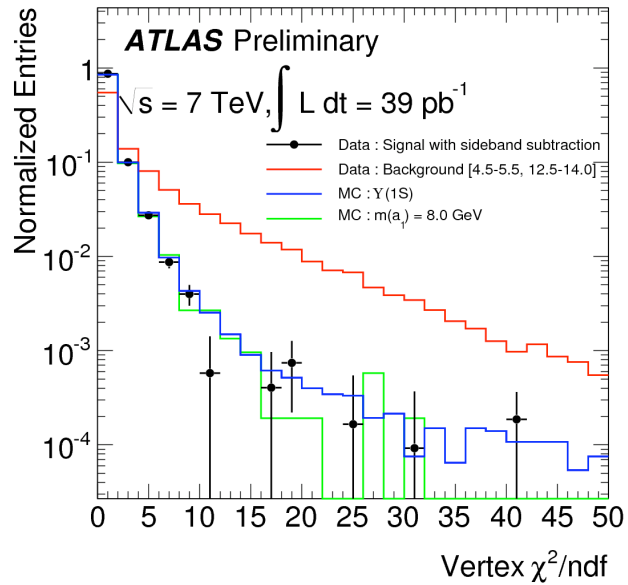

NMSSM $a_1 \rightarrow \mu^+\mu^-$: Systematics

Source	Relative Uncertainty (%) at $m(a_1)$ (GeV)							
	6.0	6.5	7.0	7.5	8.0	8.5	11.0	11.5
Luminosity	±3							
PYTHIA vs MC@NLO	±67	±55	±49	±40	±36	±32	±20	±20
Dimuon Efficiency	+14 -13	+14 -13	+14 -13	+14 -13	+14 -13	+14 -13	+15 -14	+15 -14
Trigger Correction	±8							
MC Statistics	±10	±10	±10	±10	±10	±10	±9	±9
Likelihood Ratio Modeling	±3							
Total (Pythia vs MC@NLO)	±70	±59	±53	±45	±41	±37	±28	±28