

MuMu->MuMuWW Update

Connor Waits 3-1-22

Signal Process

Final State: 2 muons and 2 jets coming from W decays
2 Cases: $|\text{mass}(\text{mumu})-91|<15$ and $|\text{mass}(\text{mumu})-91|>15$

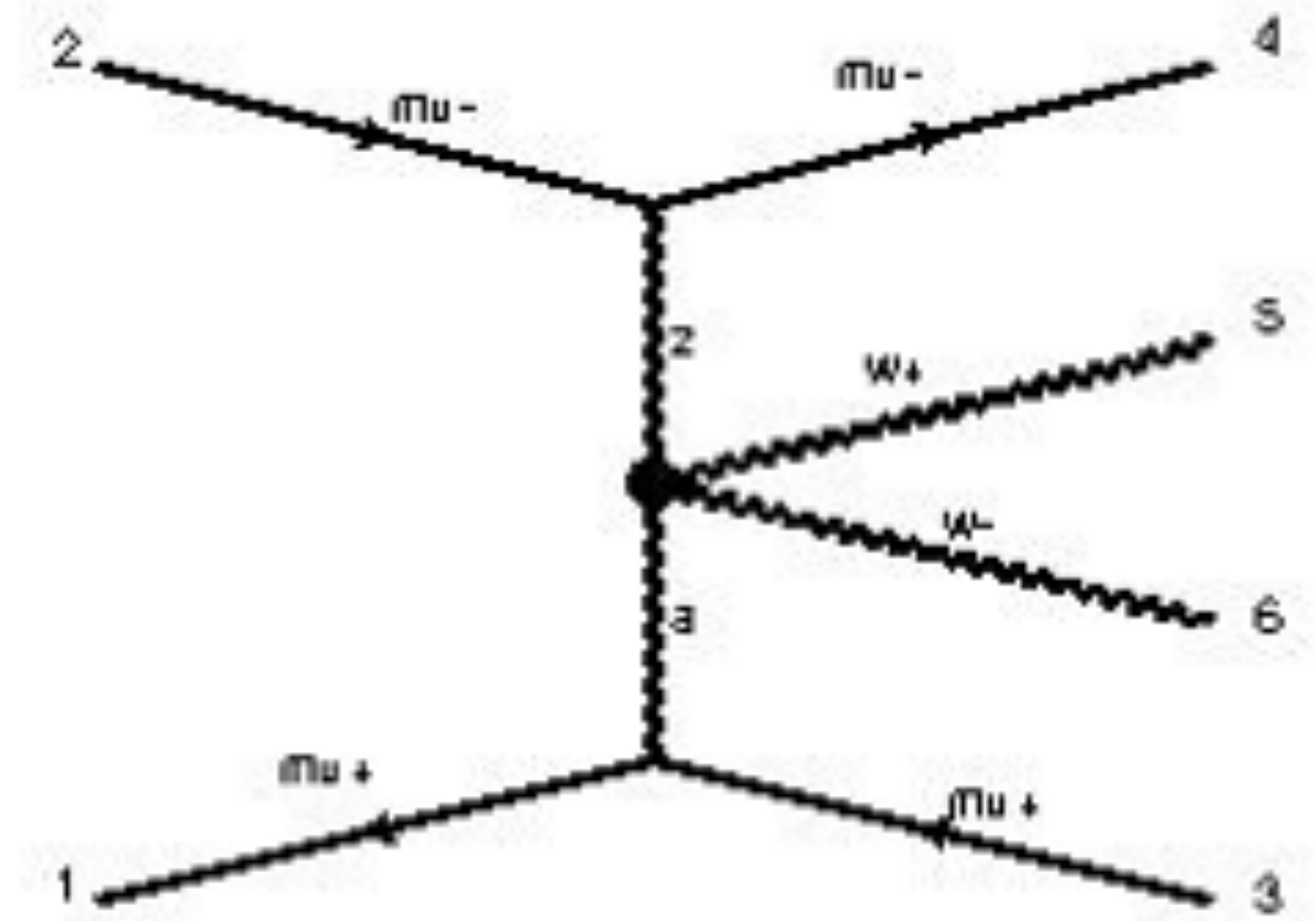
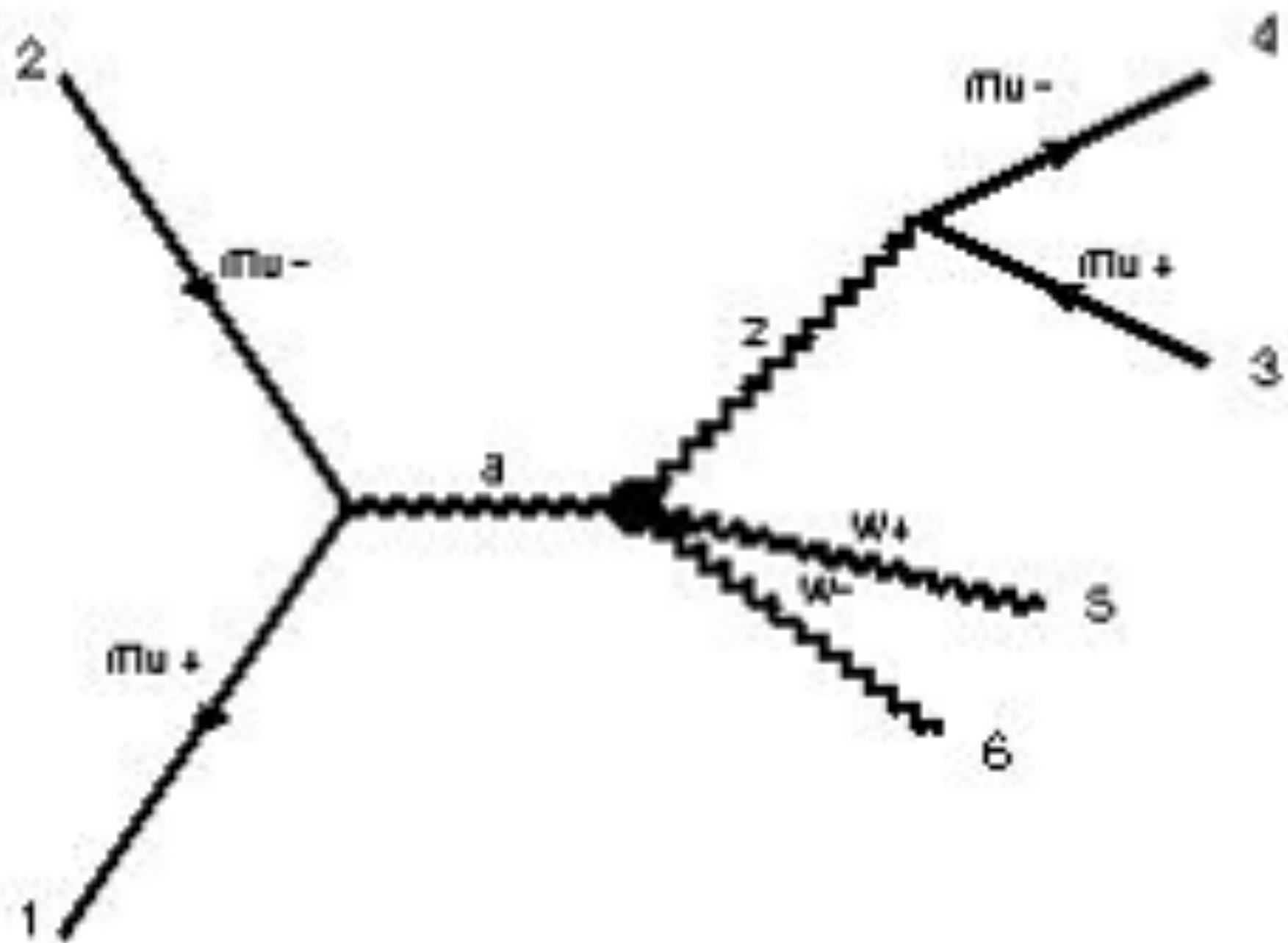

Background Processes

Diboson

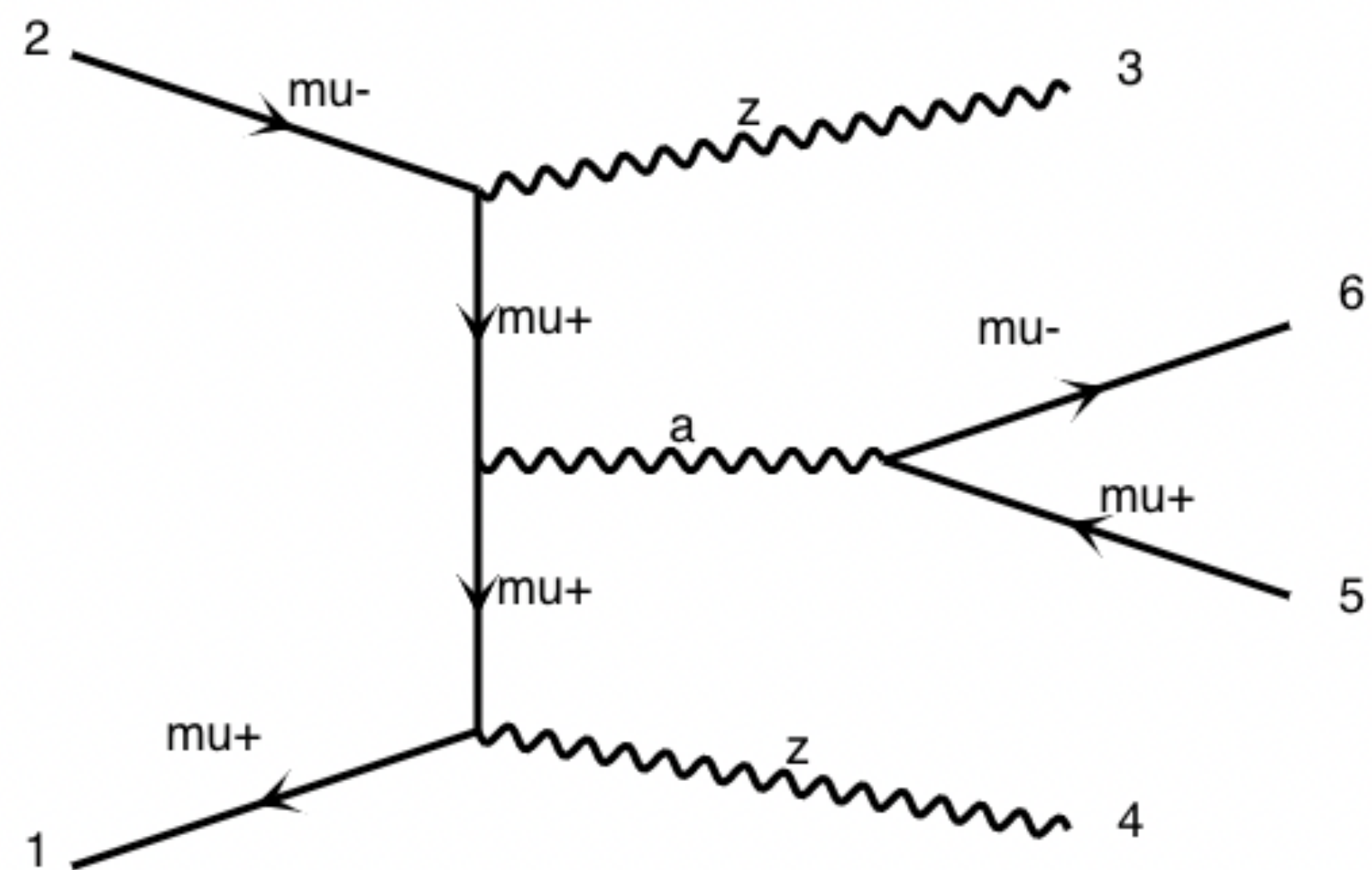

Quadiboson

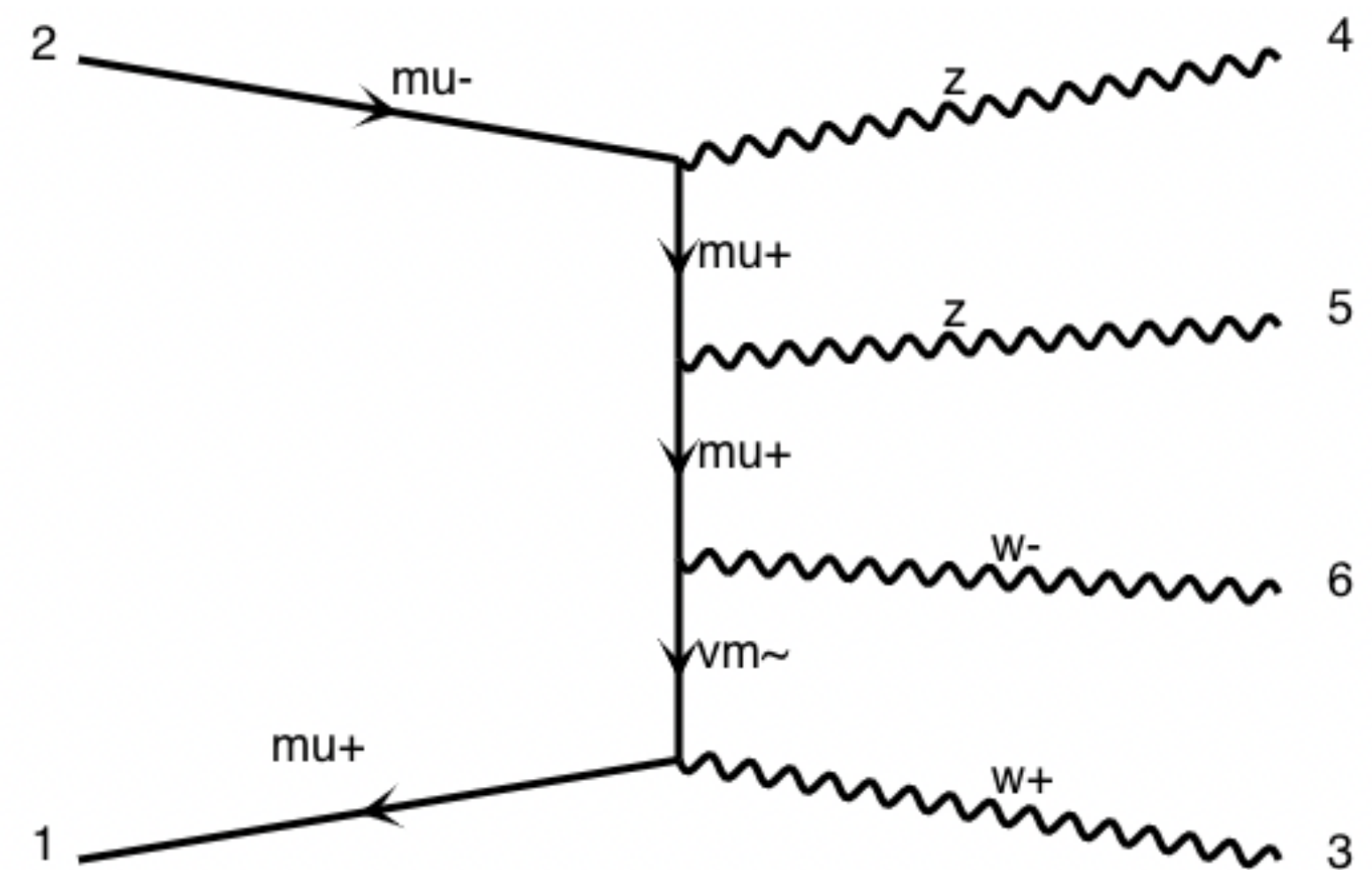

INT+QUAD

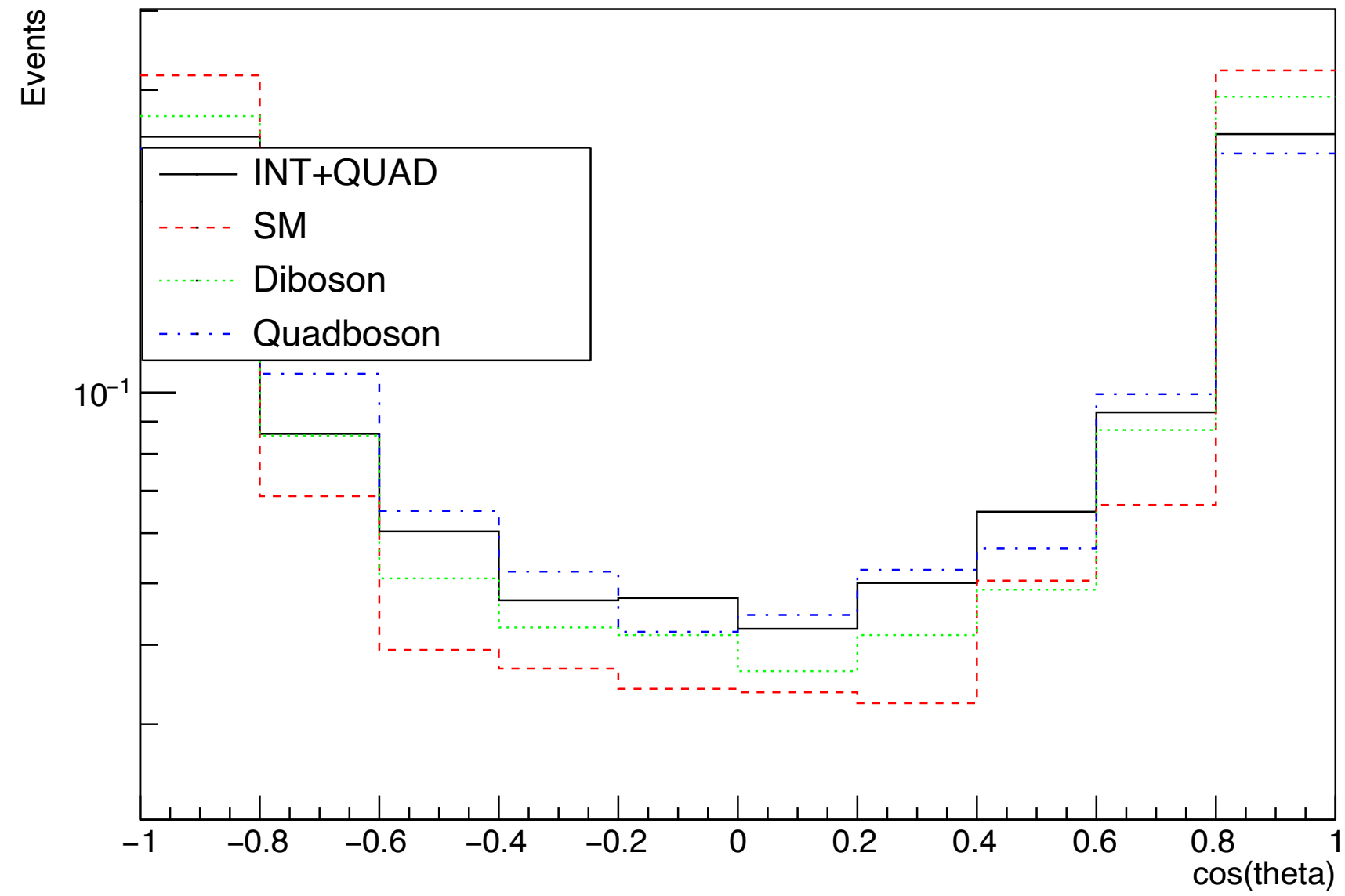

No Event Selection

All plots at 6 TeV
 Reconstructed Muons
 Leading in momentum (top)
 Sub-leading (bottom)

INT+QUAD

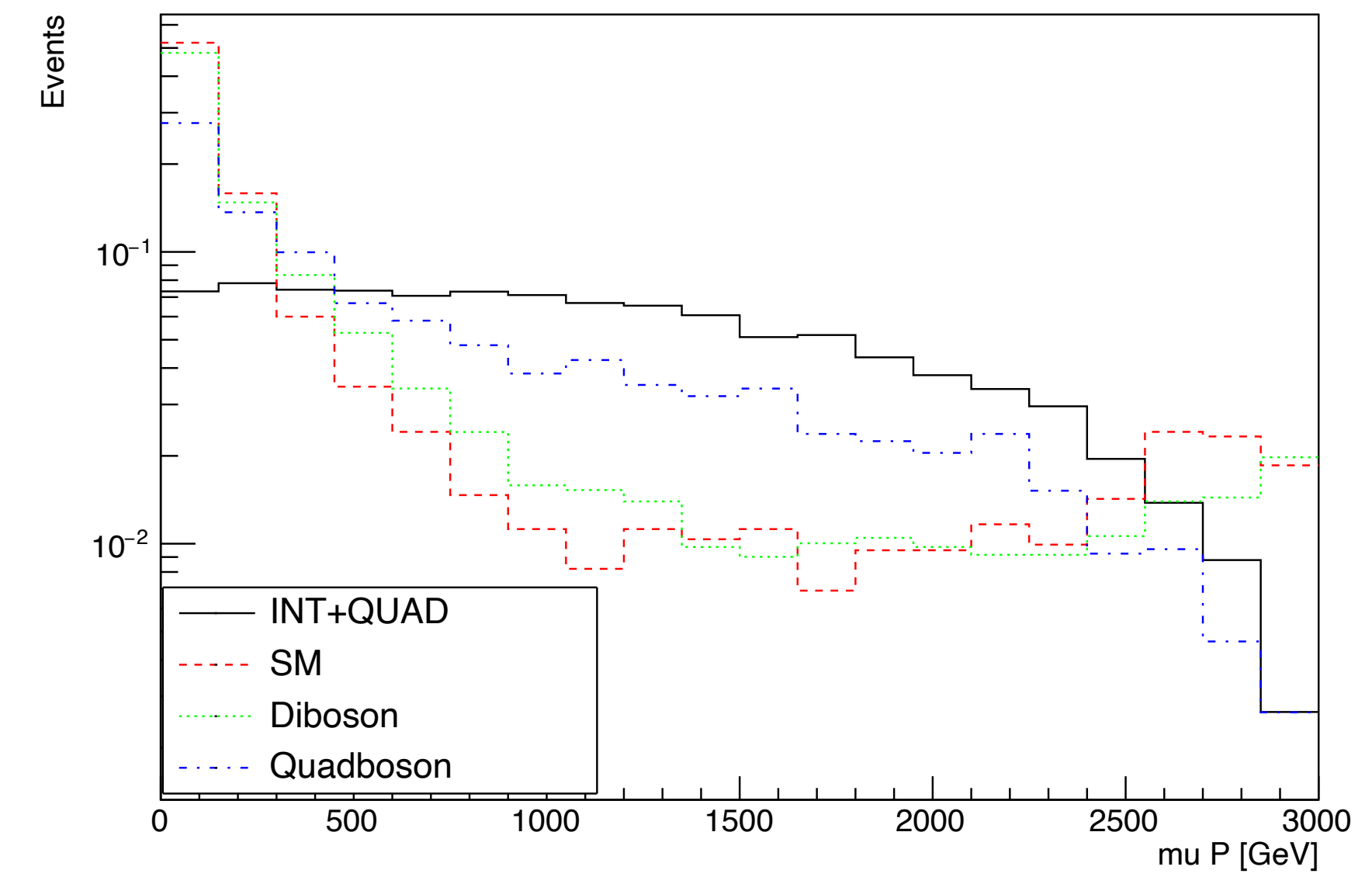

INT+QUAD

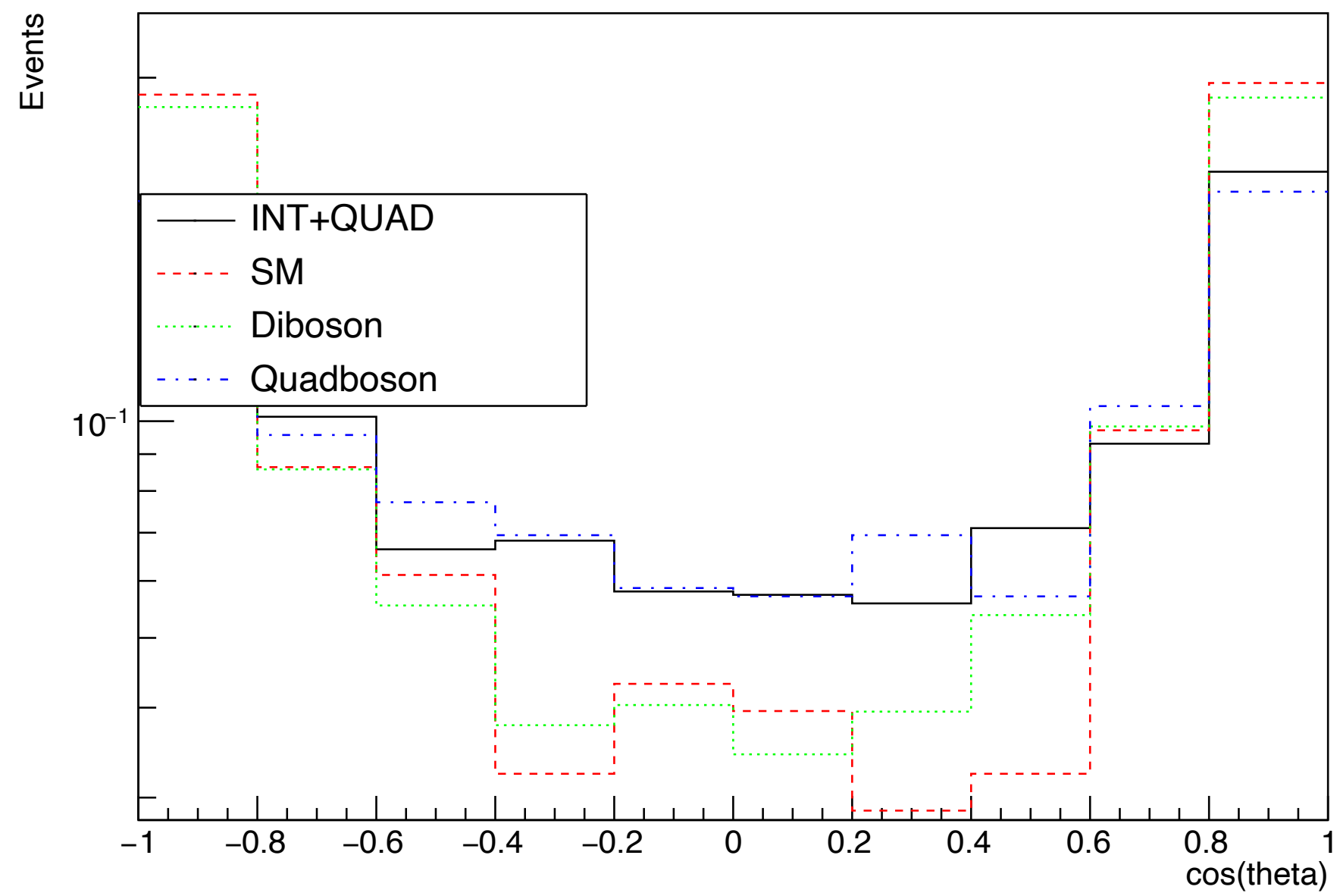

INT+QUAD

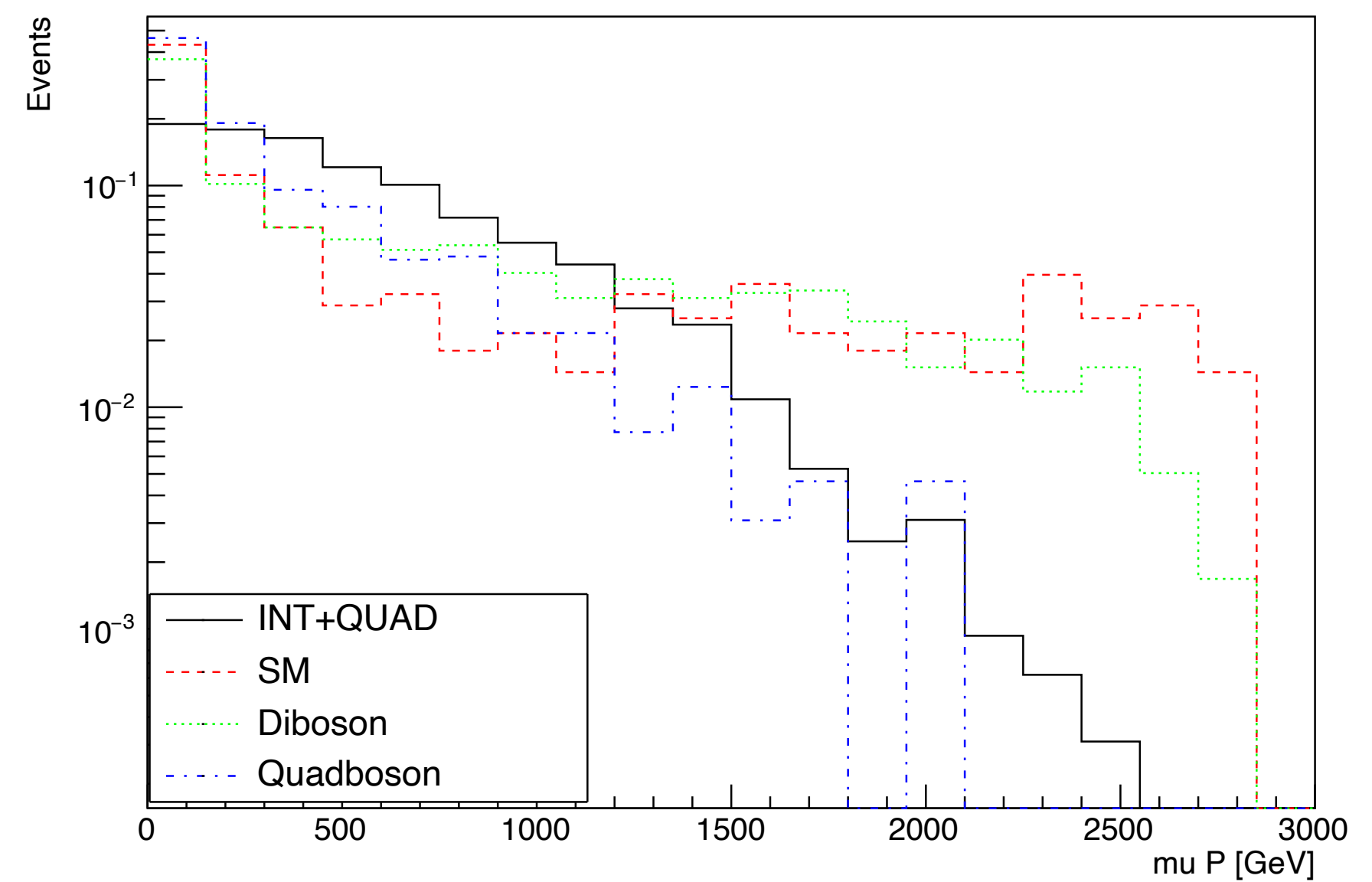

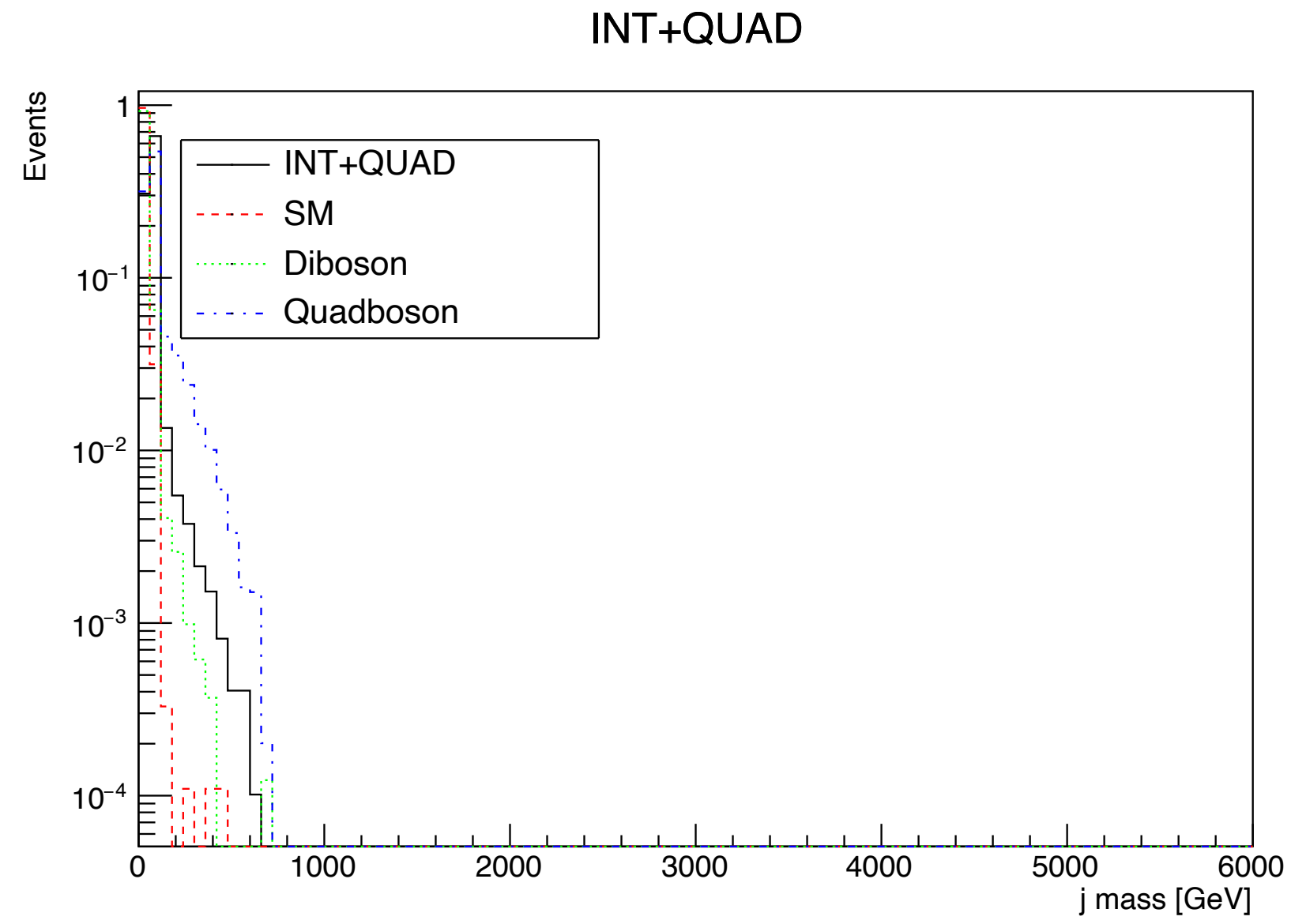

No Event Selection

All plots at 6 TeV
All jets
Leading in momentum (top)
Sub-leading (bottom)

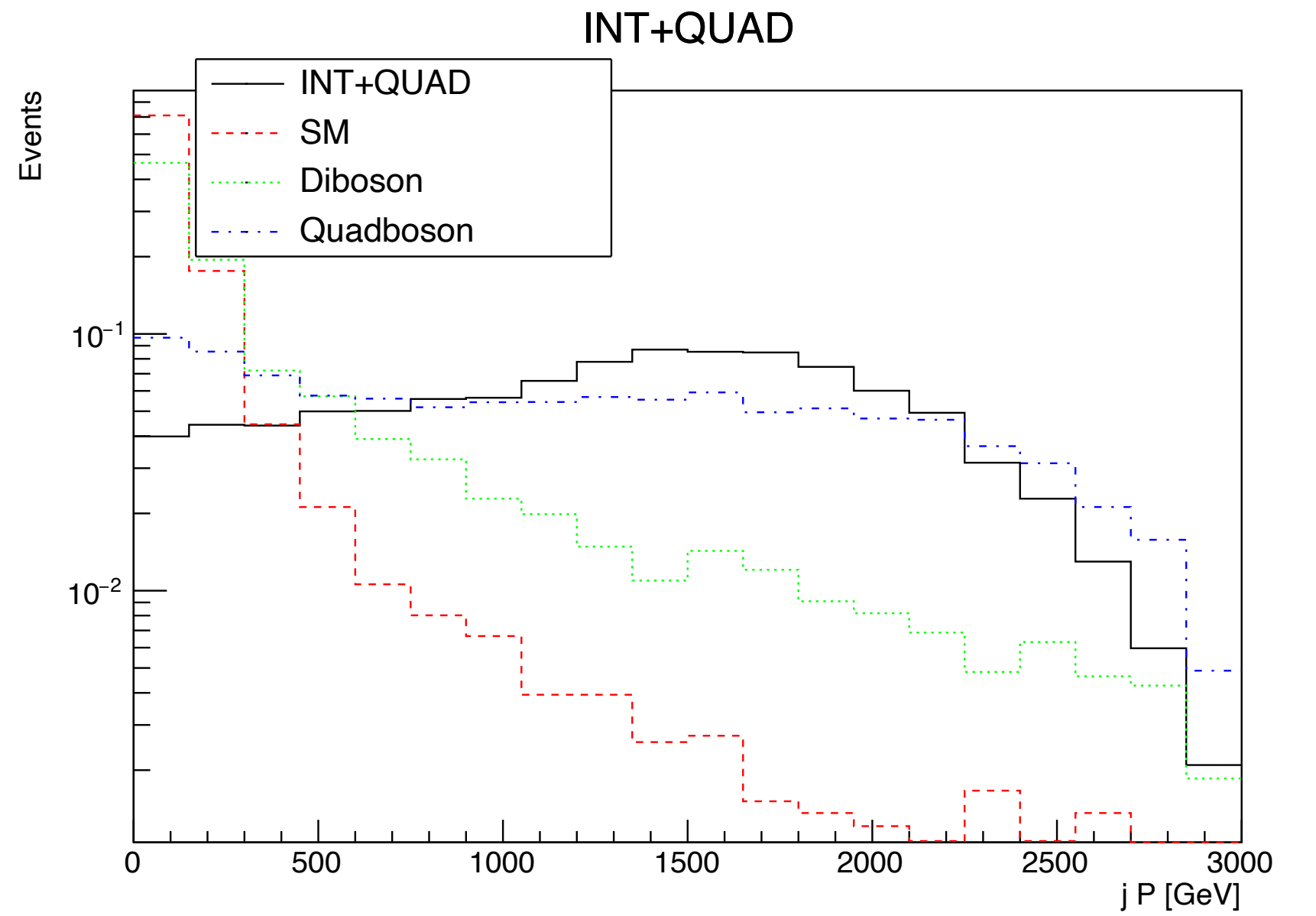
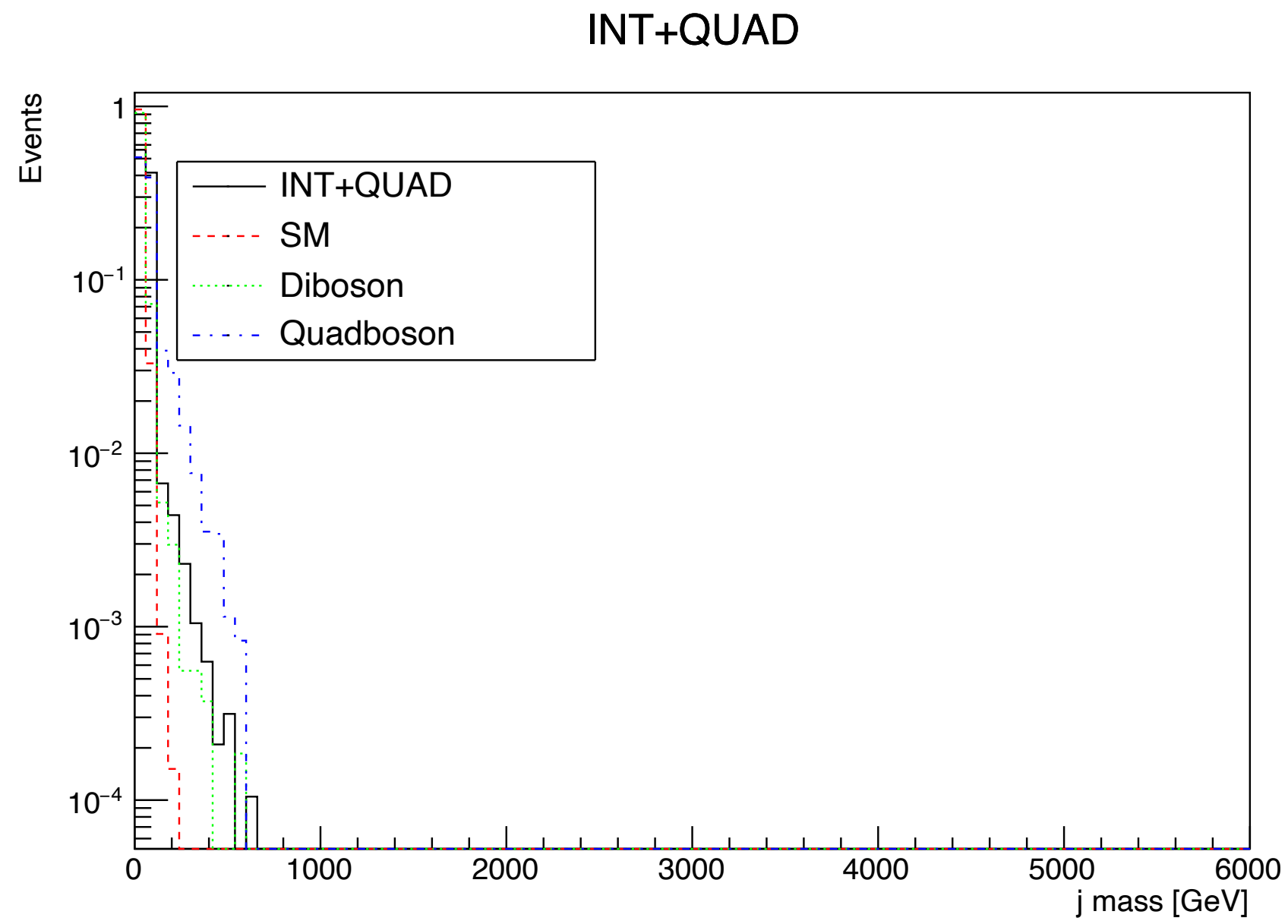
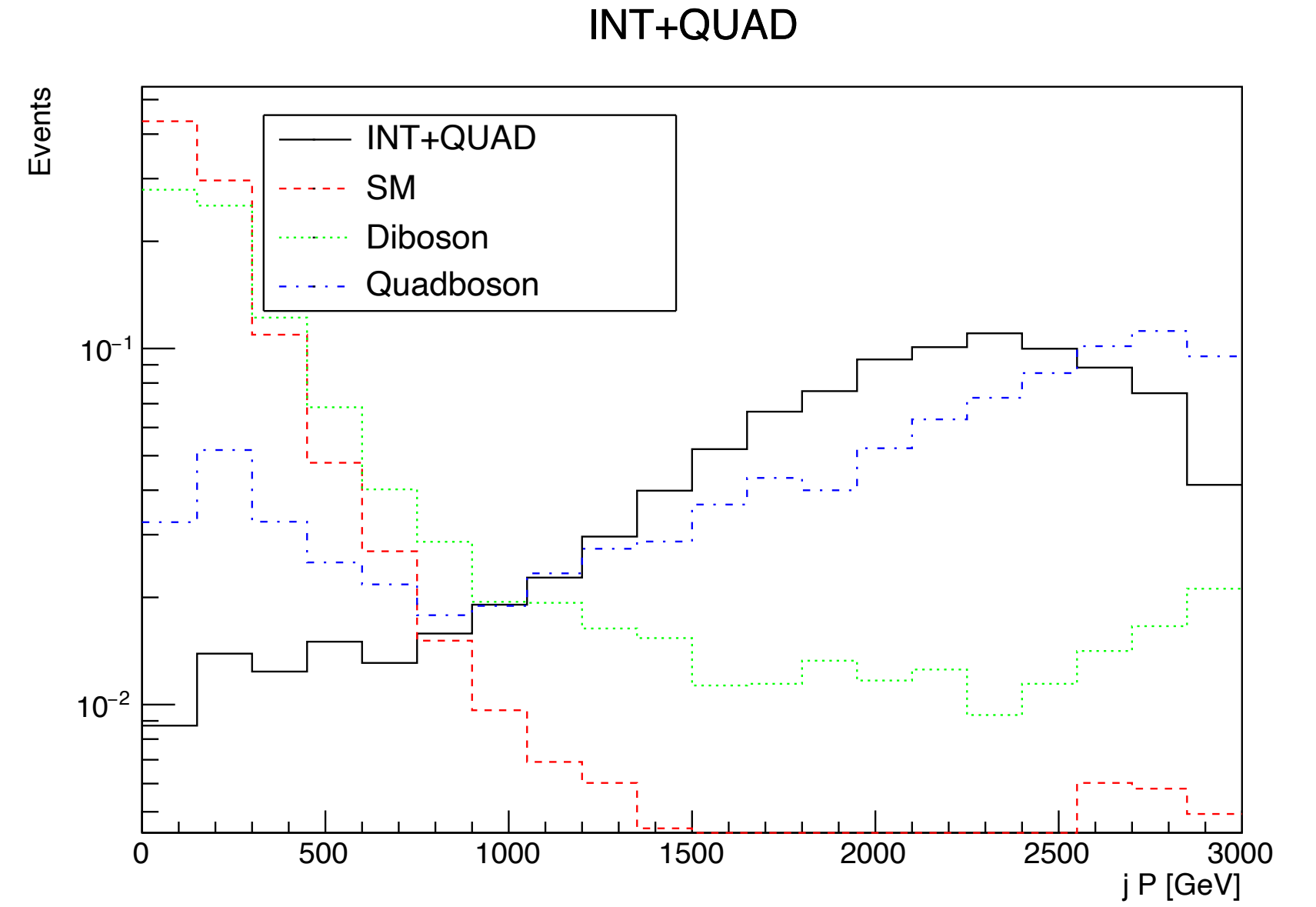

INT+QUAD

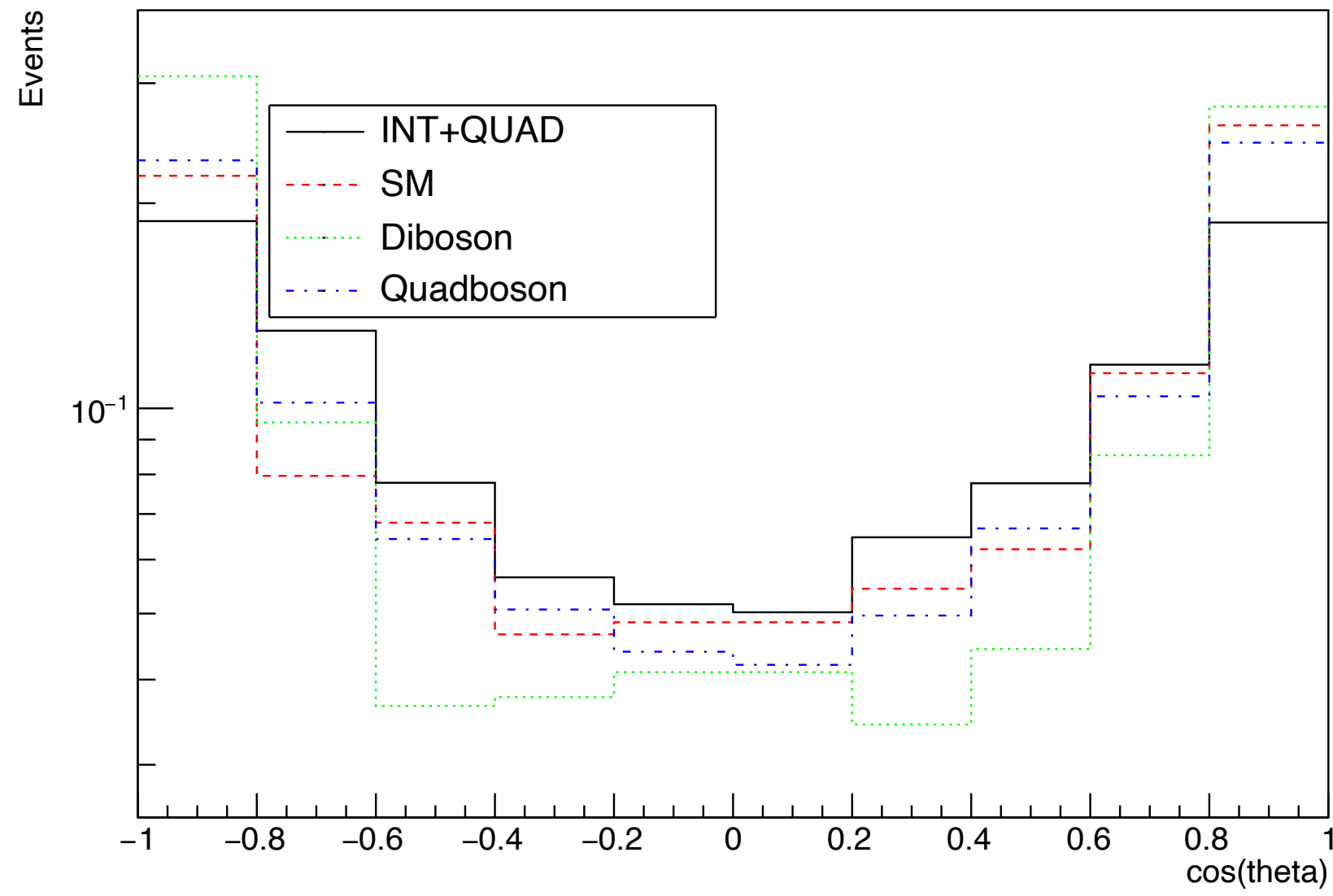

No Event Selection

All plots at 6 TeV
W-jets ($50 < \text{mass} < 100$)
Leading in momentum (top)
Sub-leading (bottom)

INT+QUAD

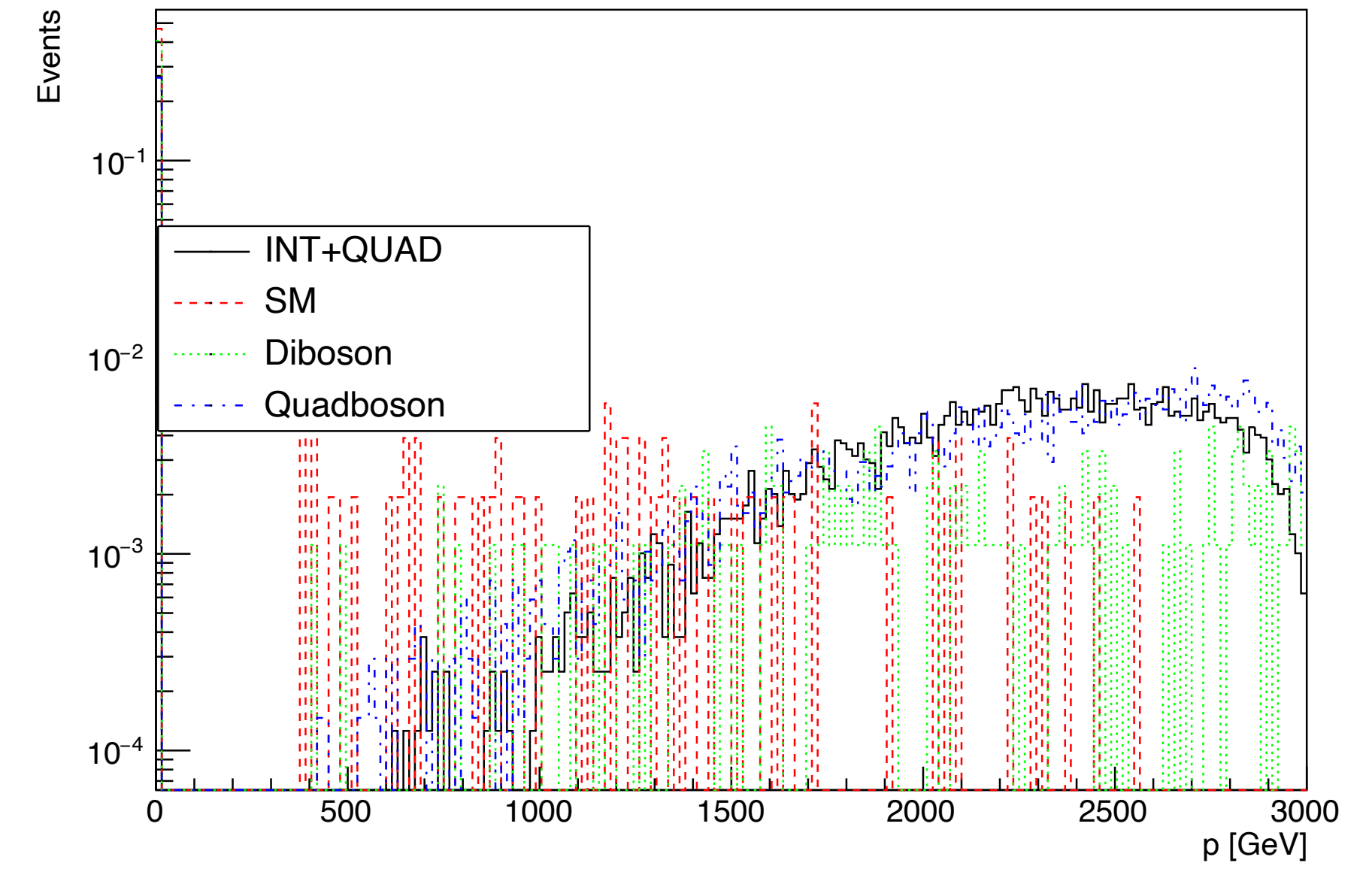

INT+QUAD

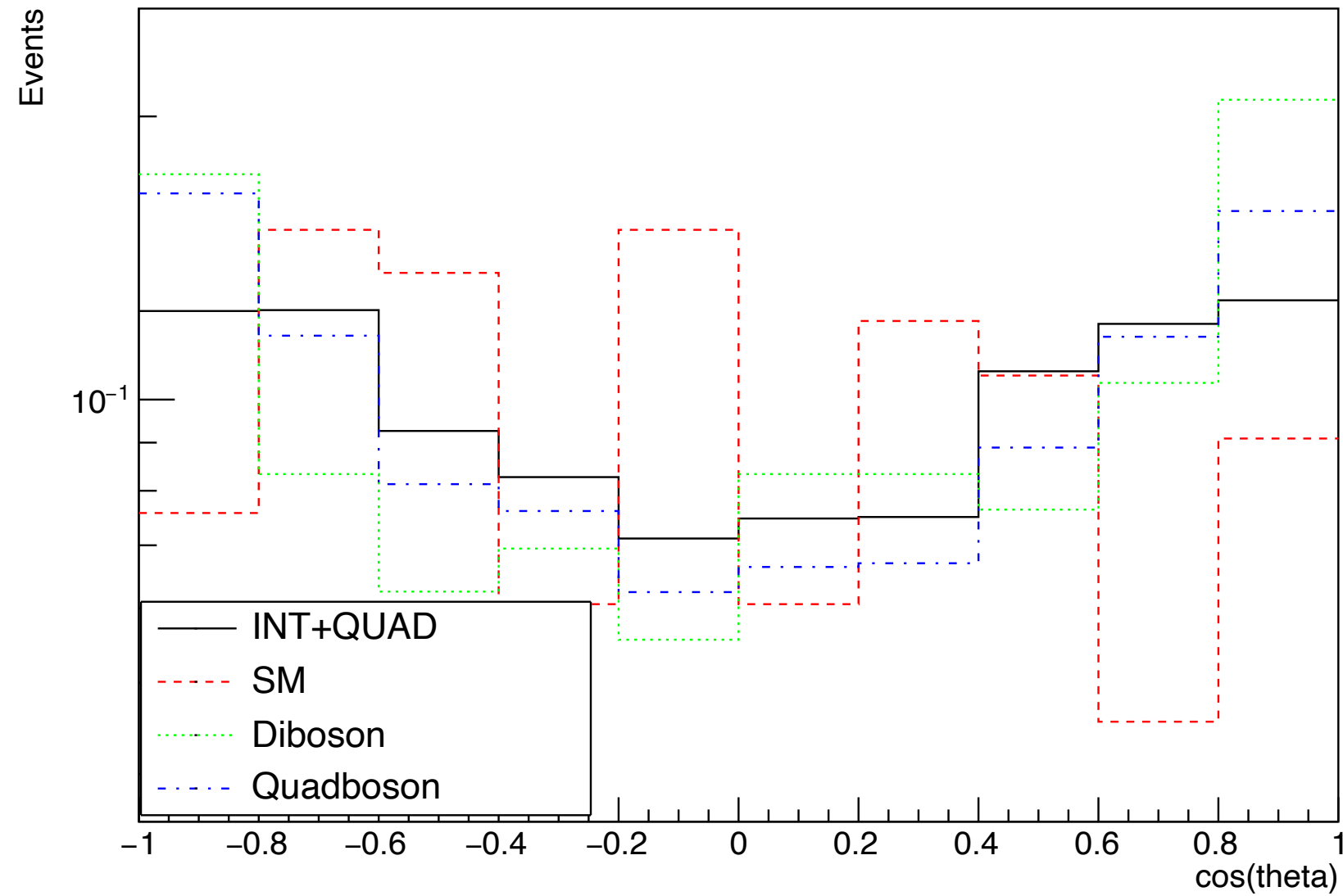

INT+QUAD

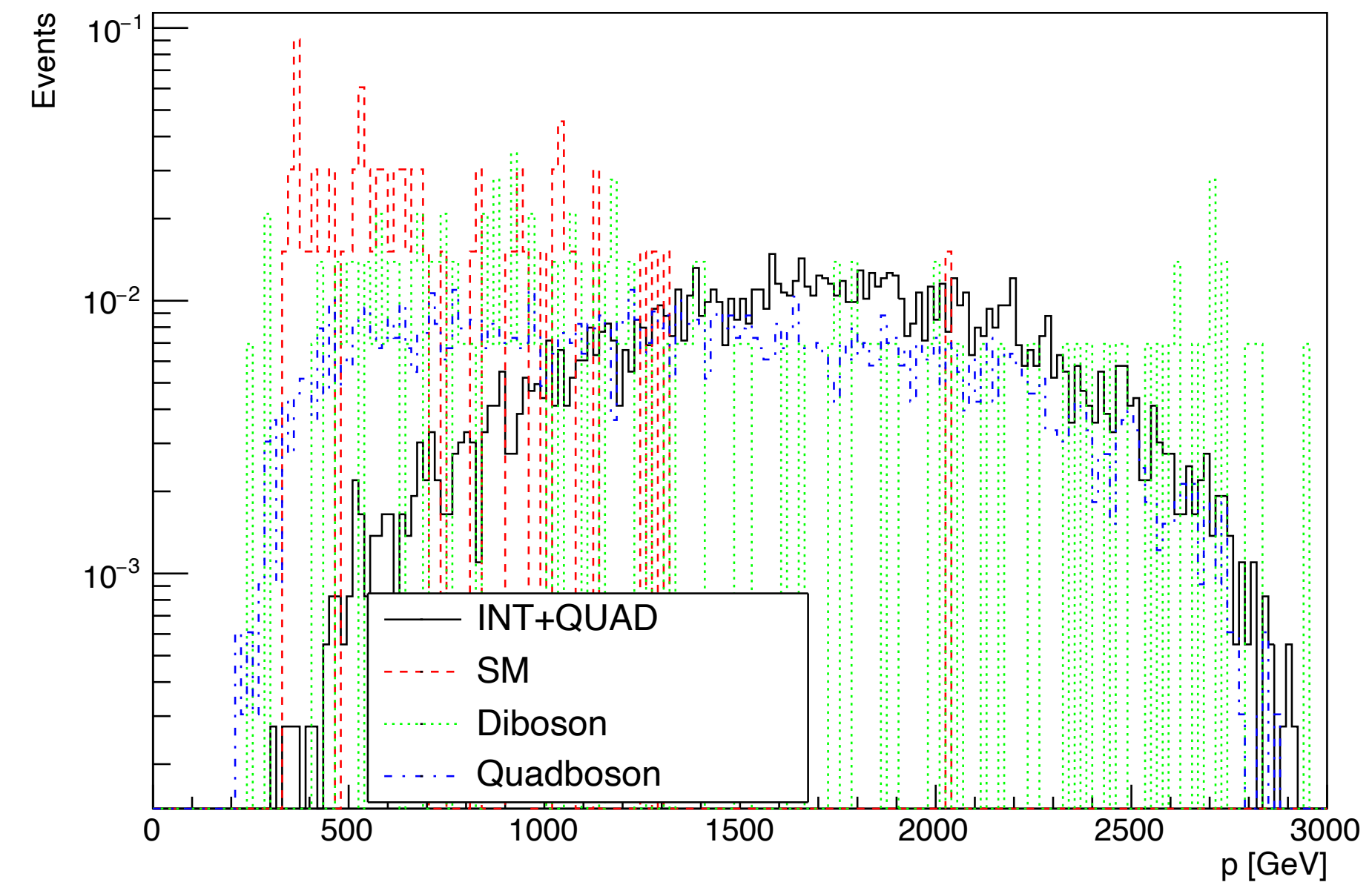

INT+QUAD

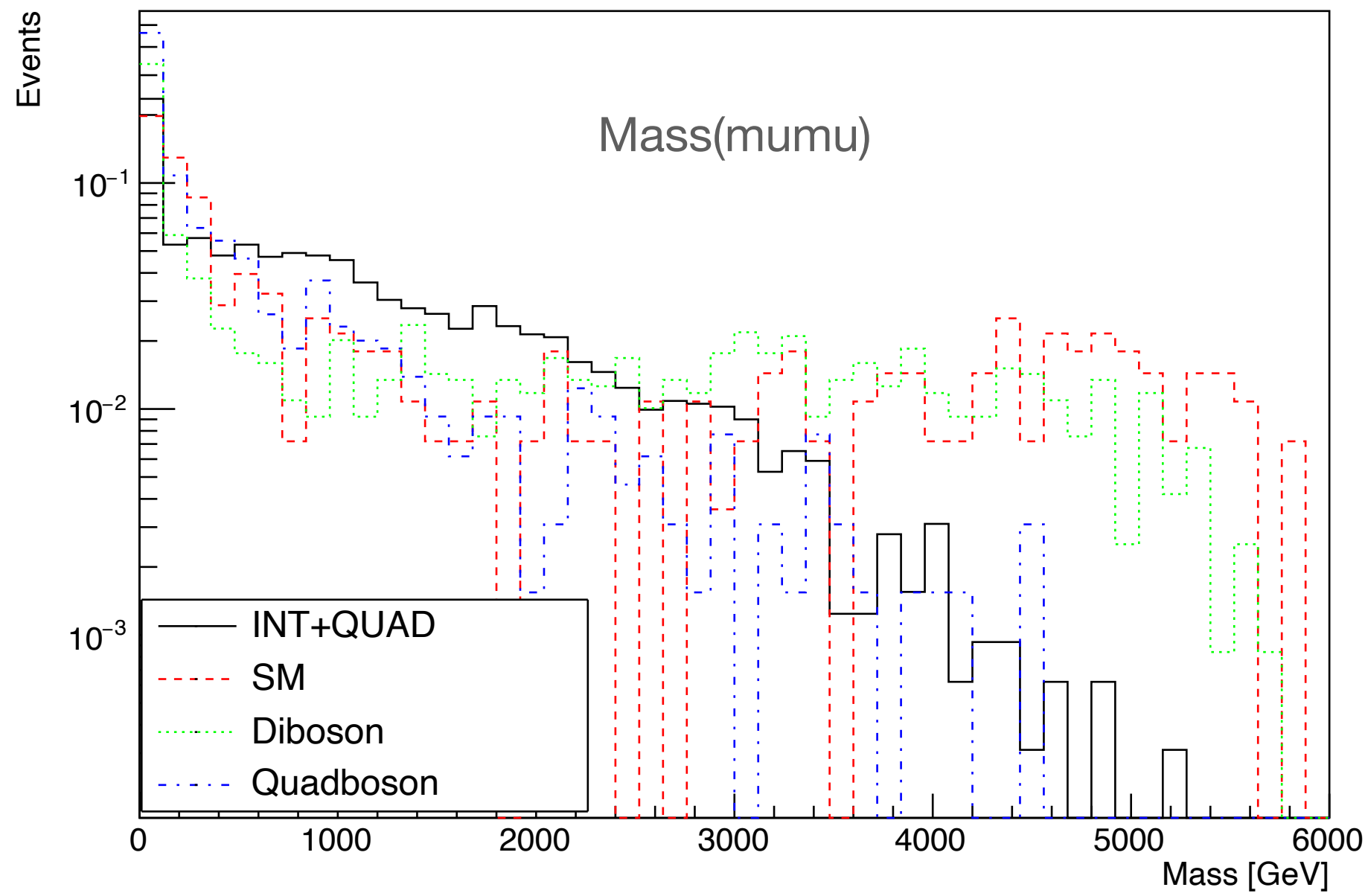

No Event Selection

All plots at 6 TeV
Muons(left) W-jets (right)

INT+QUAD

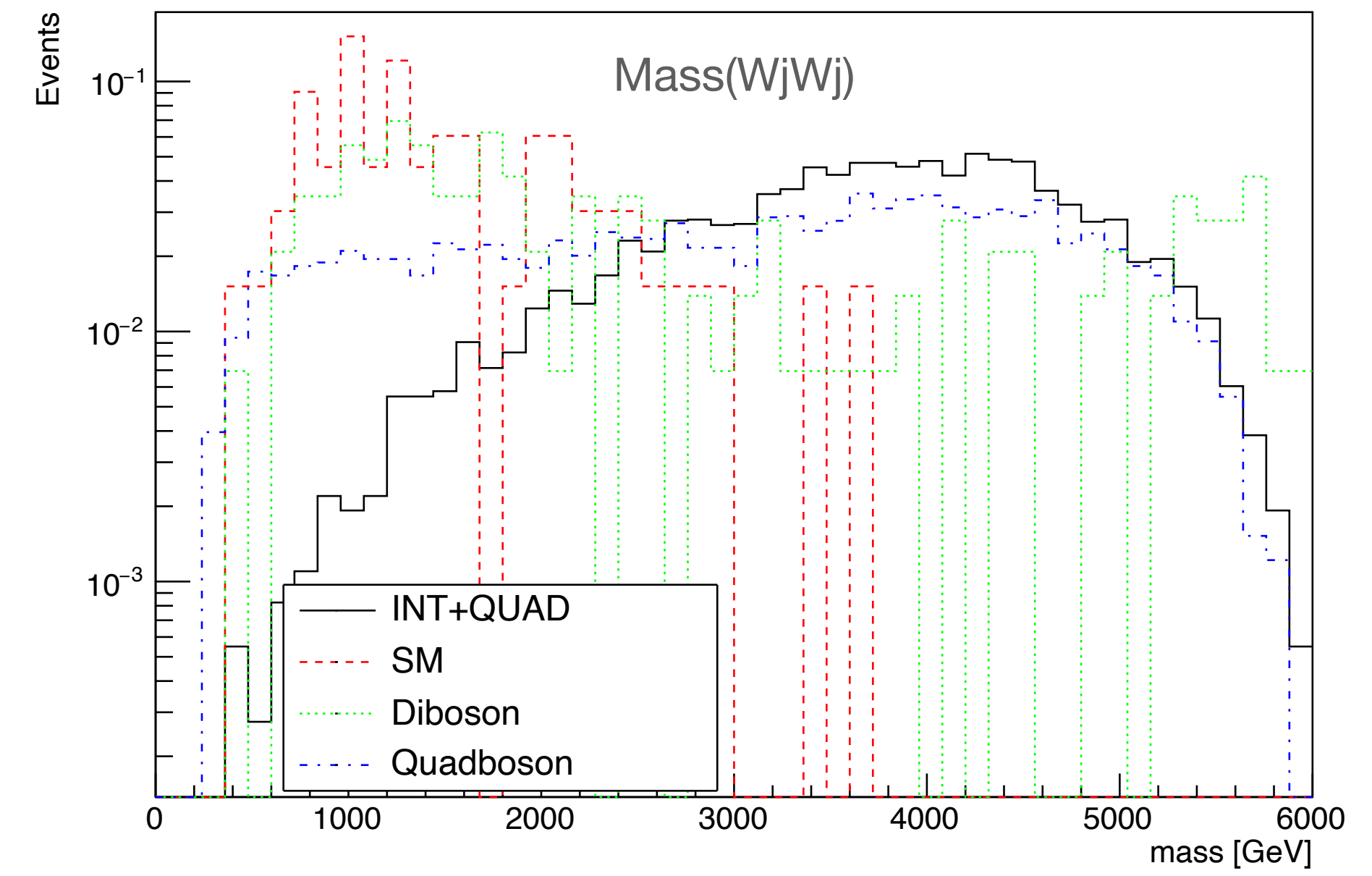

INT+QUAD

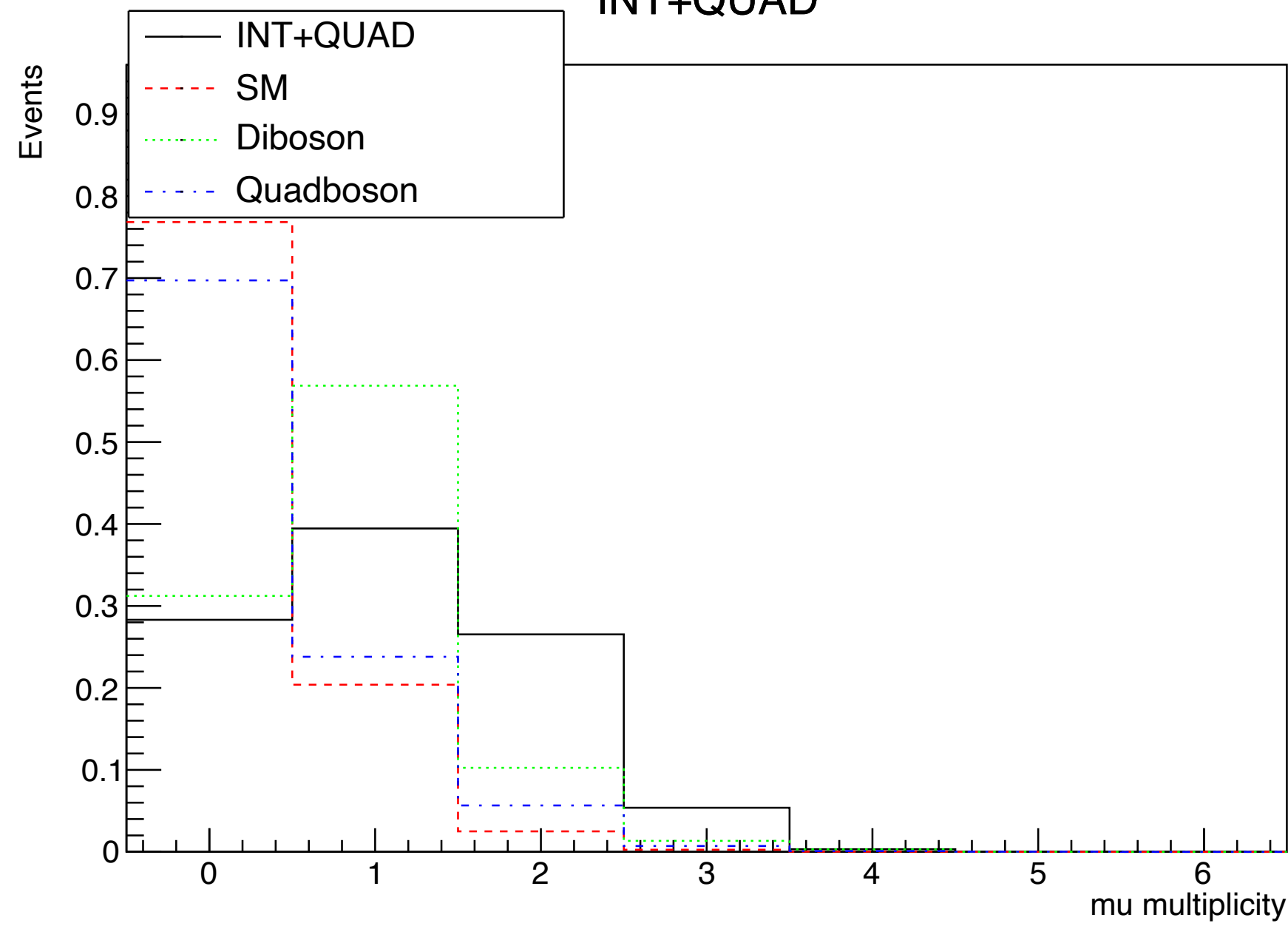

INT+QUAD

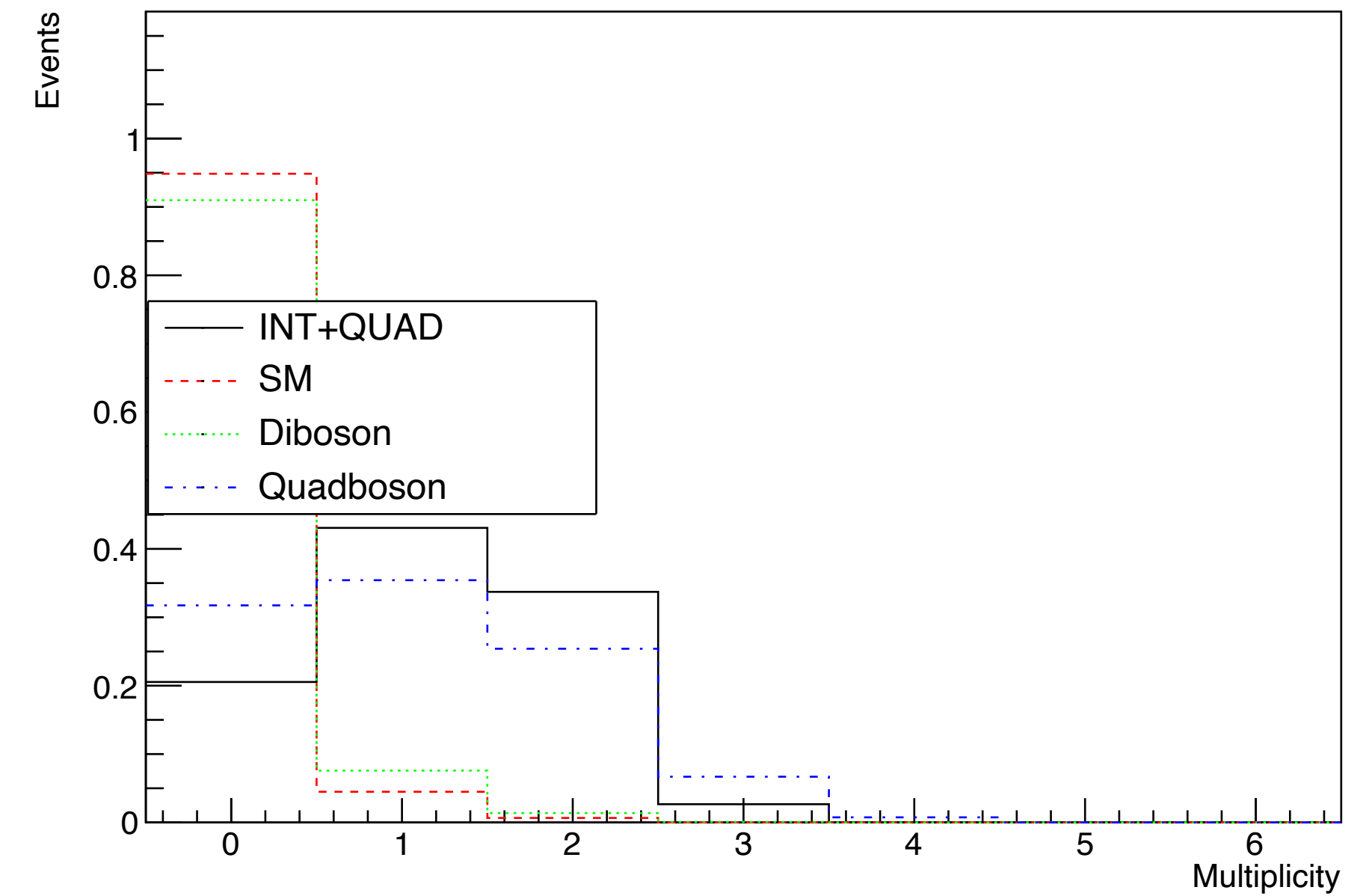

INT+QUAD

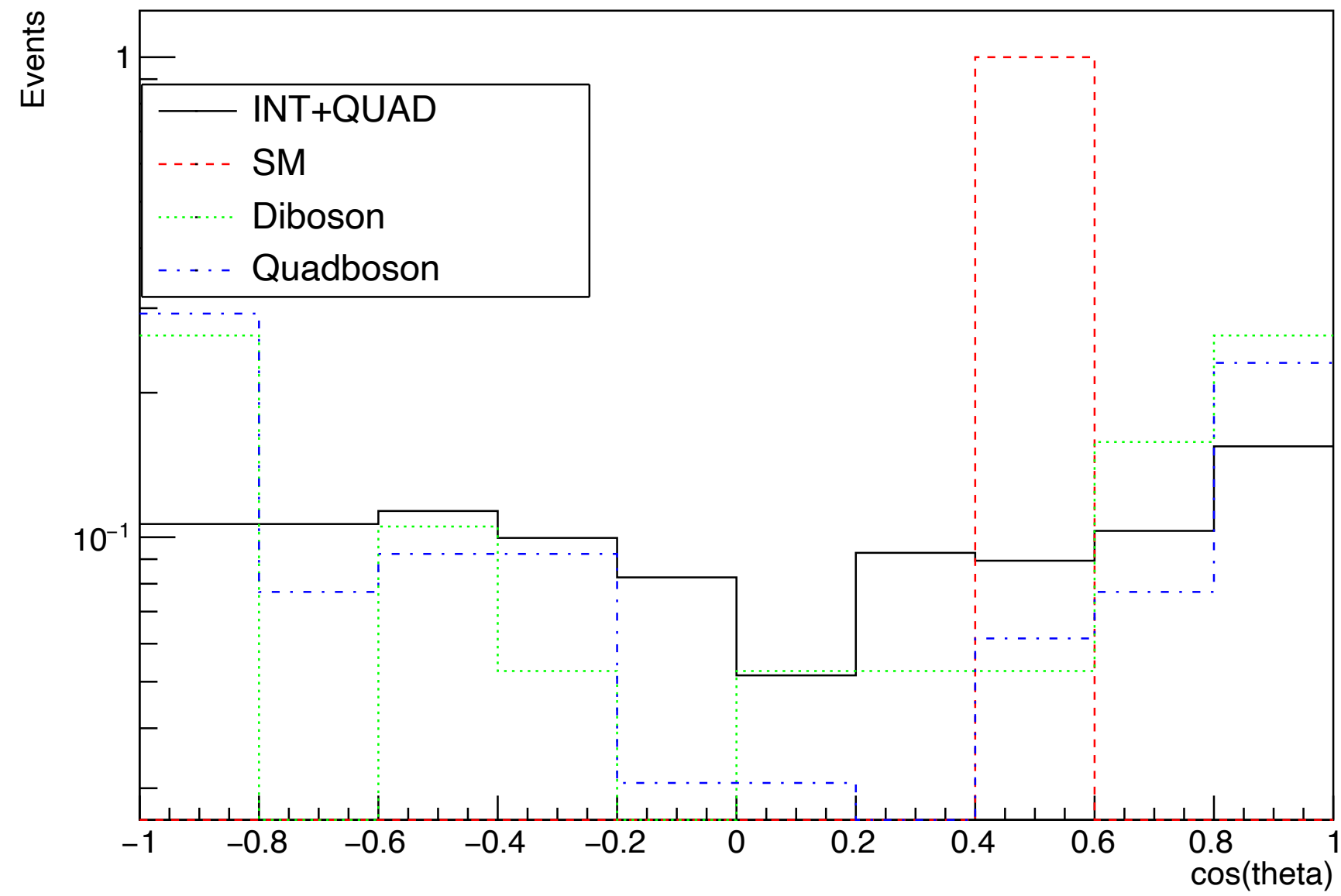

All plots at 6 TeV
 2 muons and 2 W-jets required
 $|\text{mass}(\text{mumu})-91| < 15$
 Reconstructed Muons
 Leading in momentum (top)
 Sub-leading (bottom)

INT+QUAD

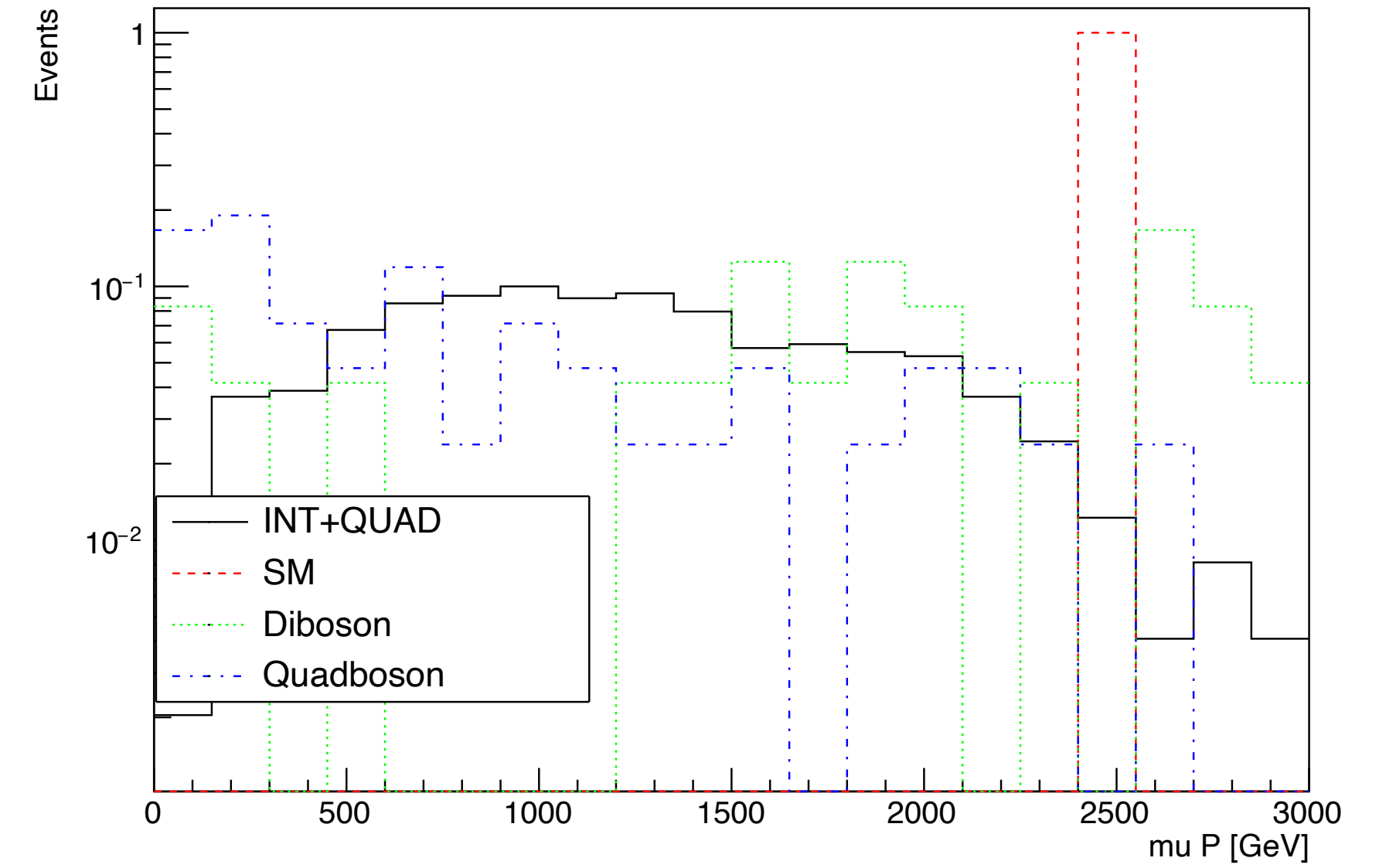

INT+QUAD

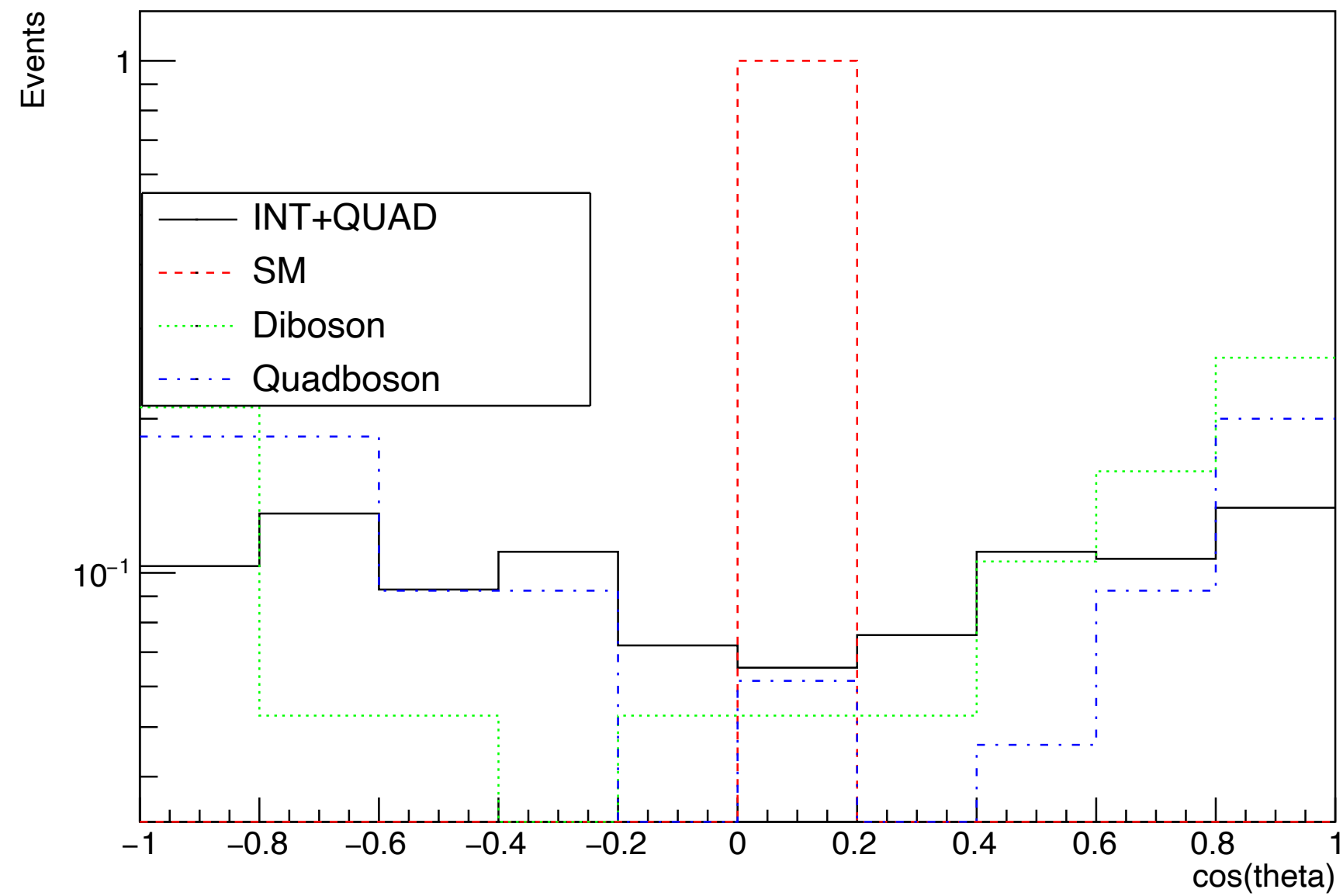

INT+QUAD

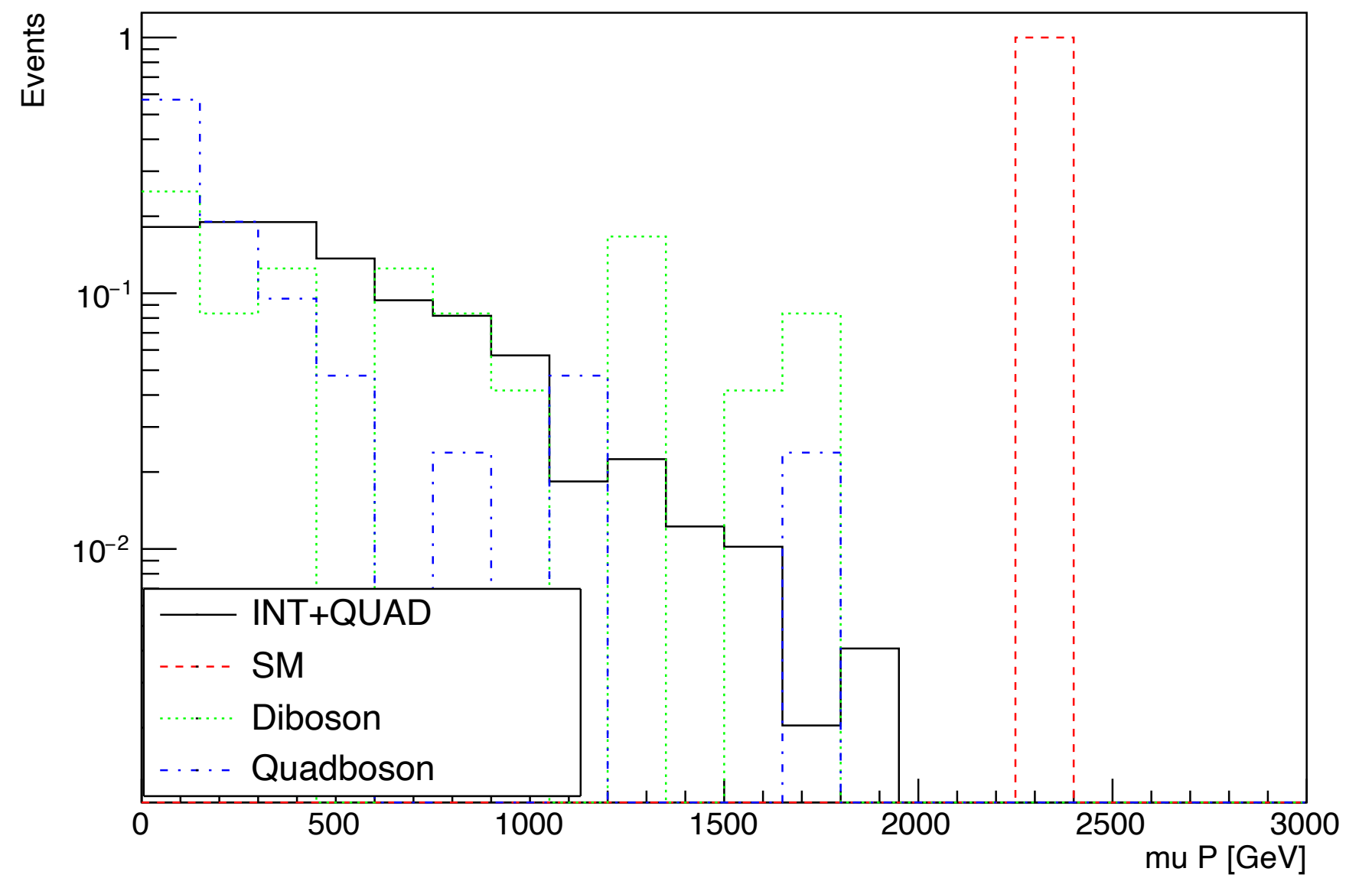

INT+QUAD

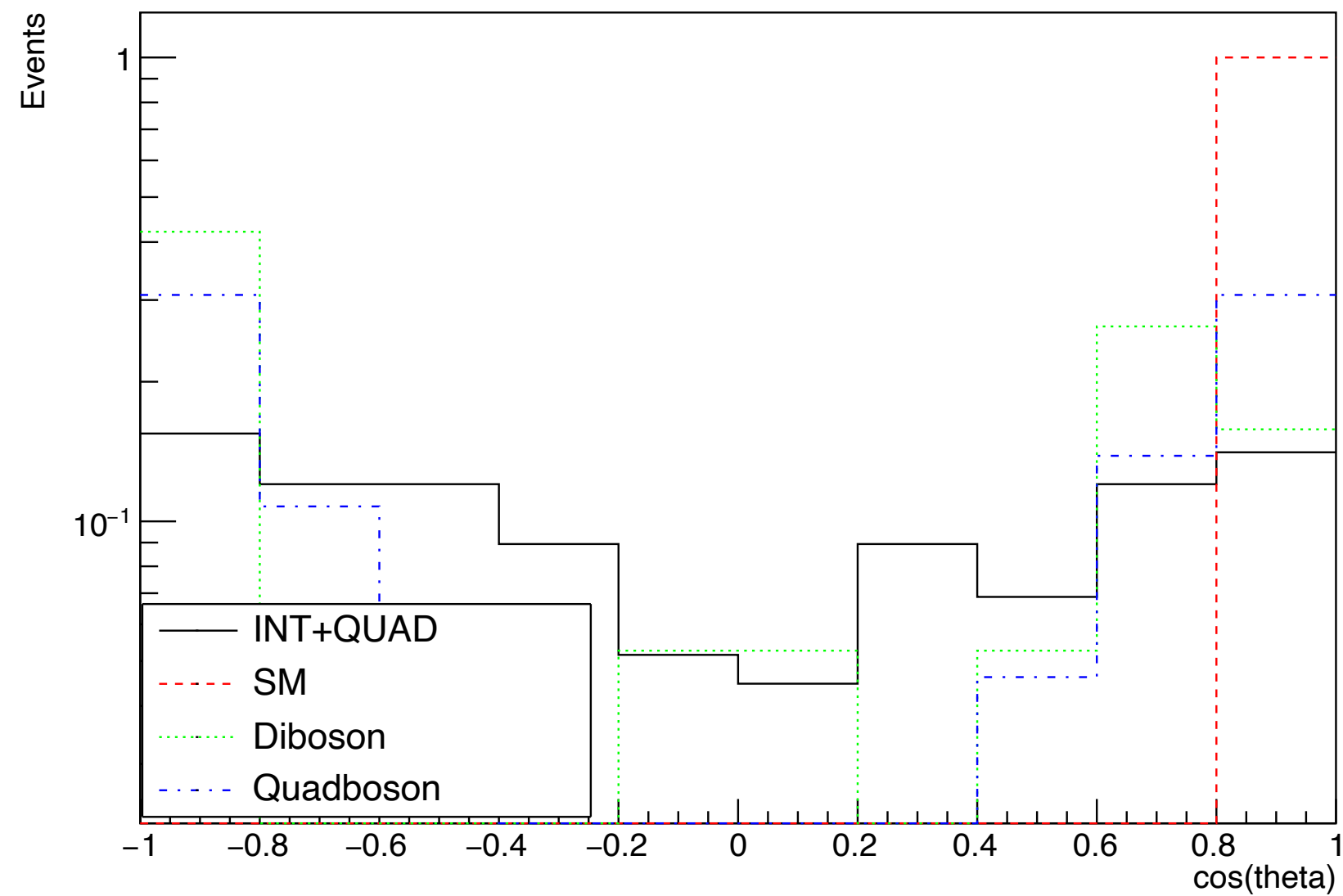

All plots at 6 TeV
2 muons and 2 W-jets required
 $|\text{mass}(\mu\mu) - 91| < 15$
W-jets ($50 < \text{mass} < 100$)
Leading in momentum (top)
Sub-leading (bottom)

INT+QUAD

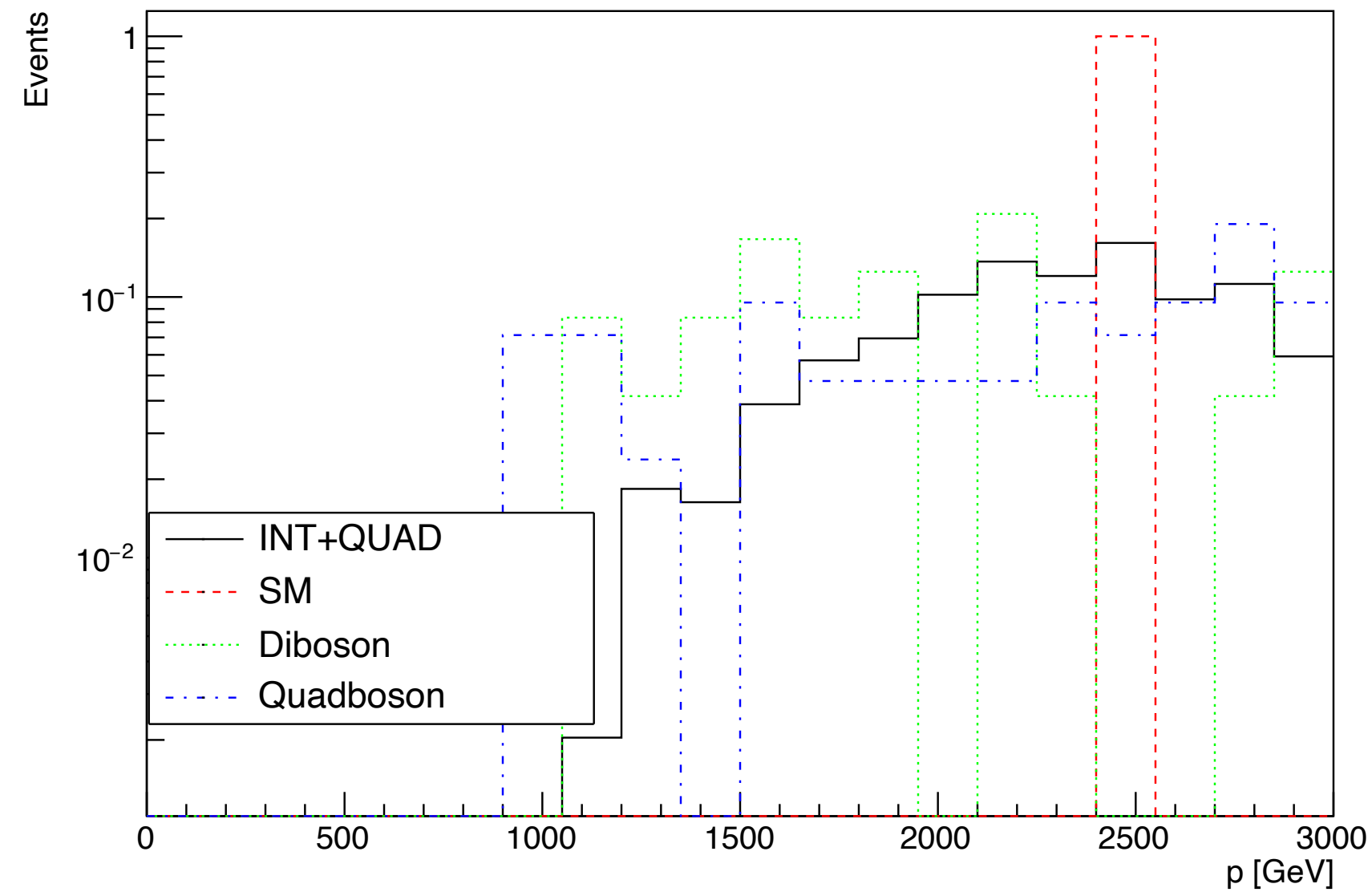

INT+QUAD

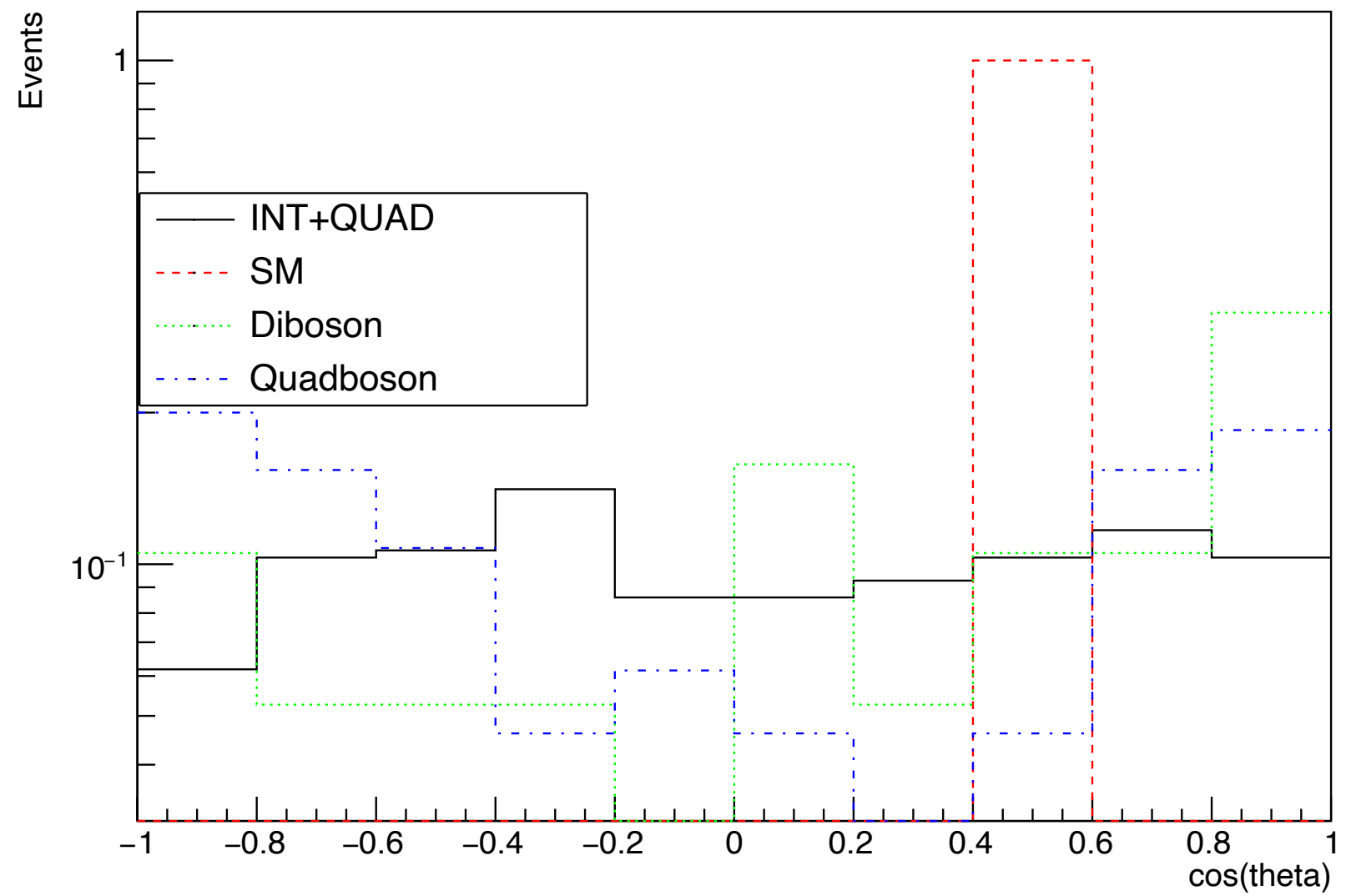

INT+QUAD

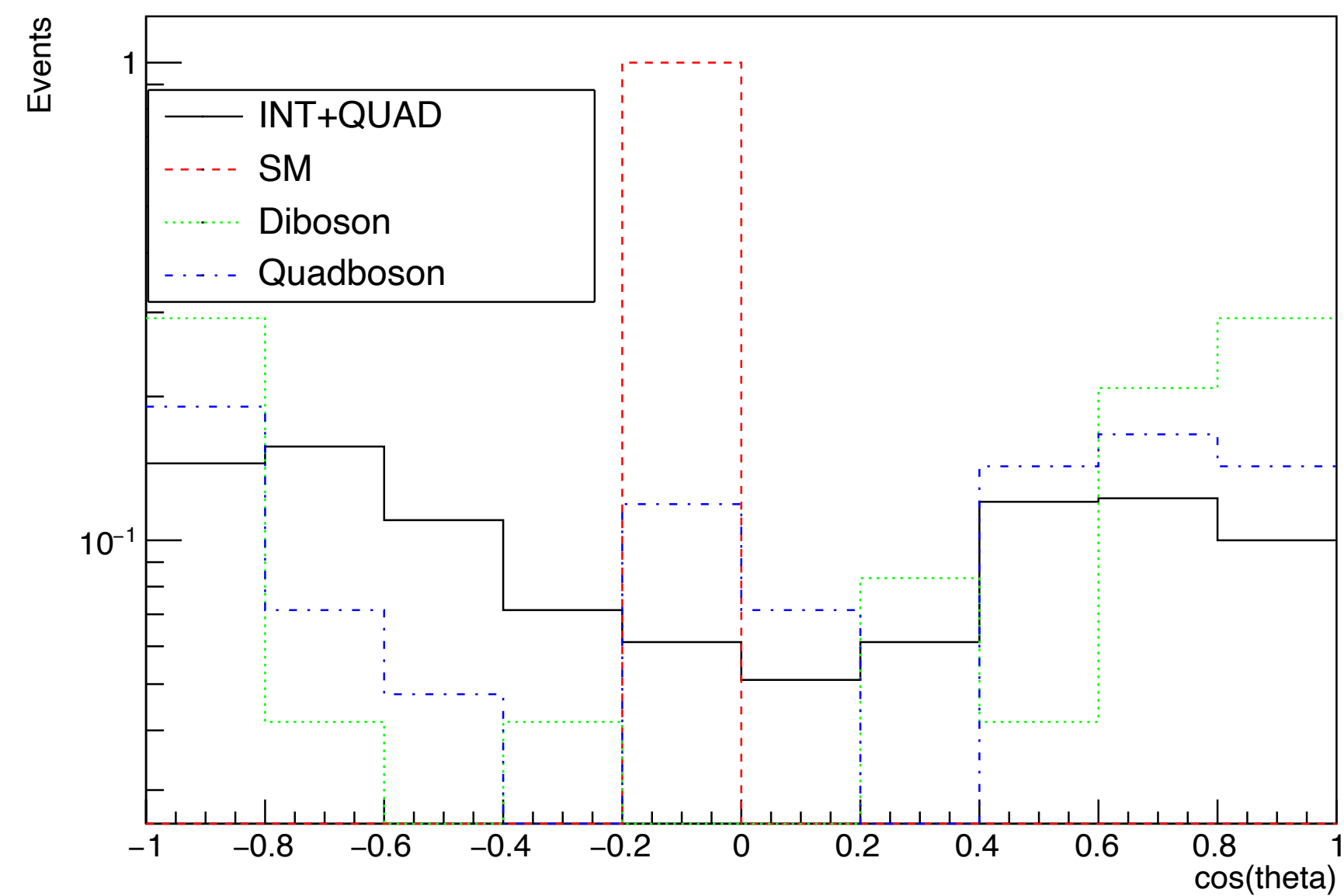

INT+QUAD

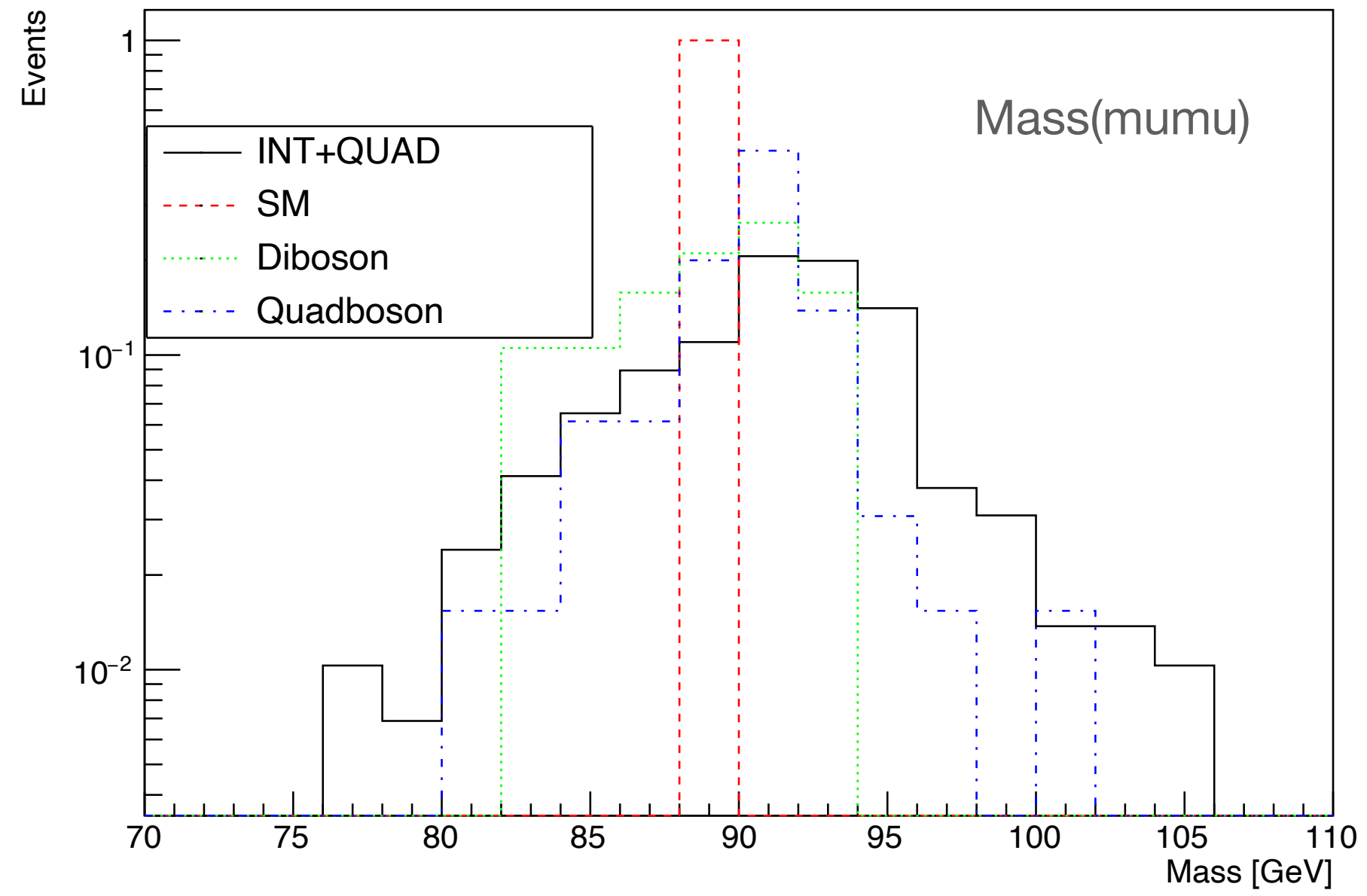

All plots at 6 TeV
 2 muons and 2 W-jets required
 $|\text{mass}(mumu) - 91| < 15$
 Muons(left) W-jets (right)

INT+QUAD

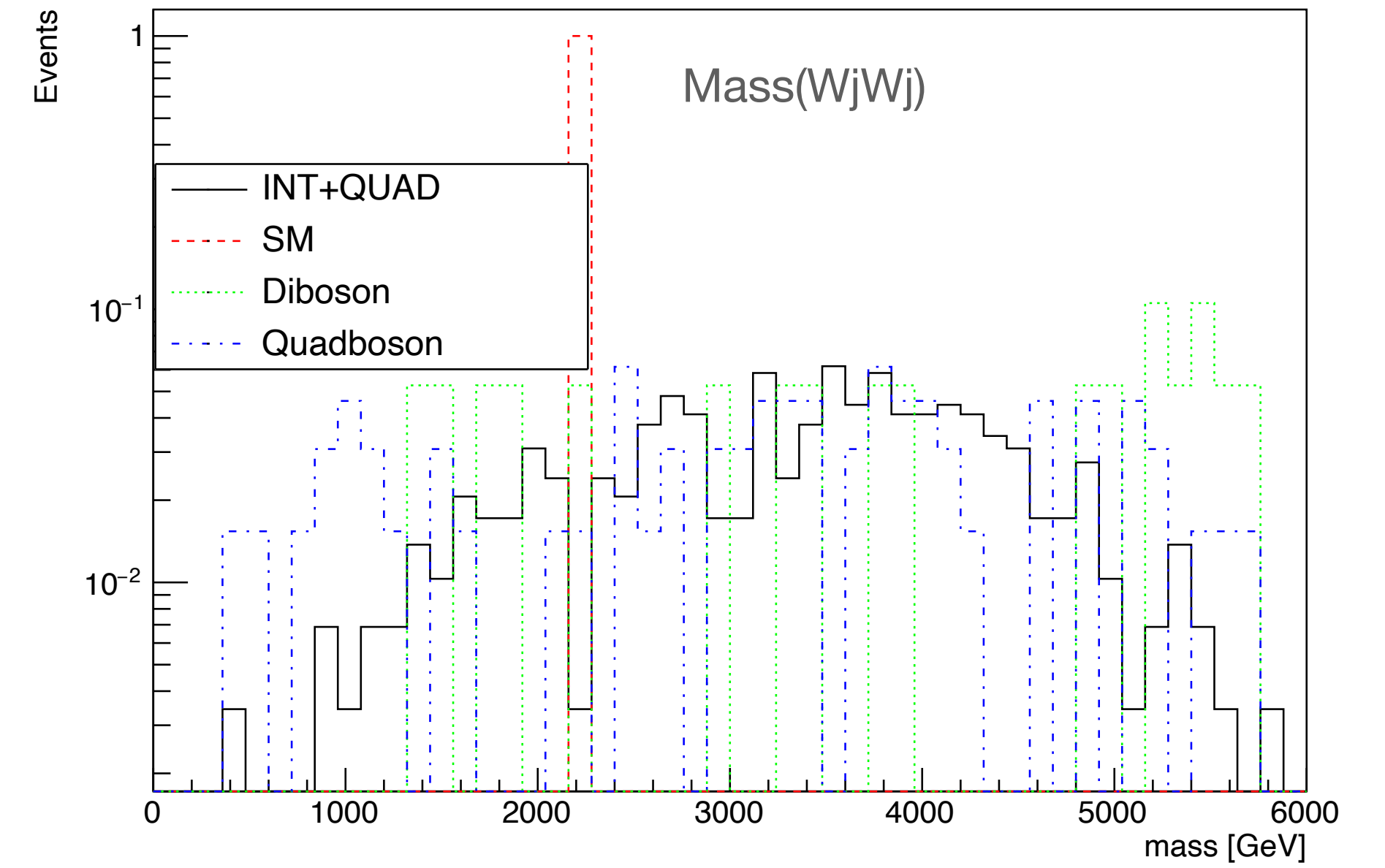

INT+QUAD

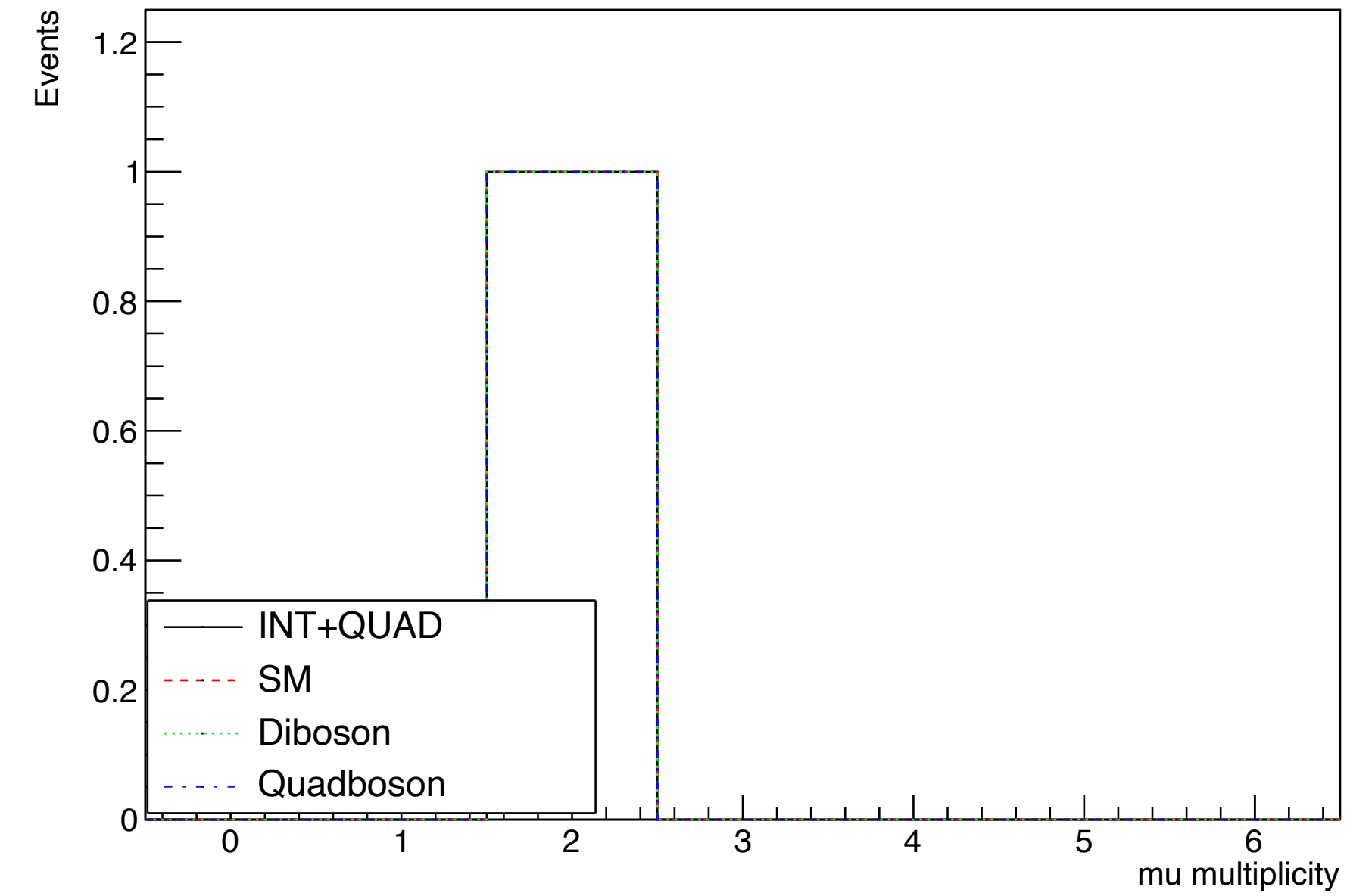

INT+QUAD

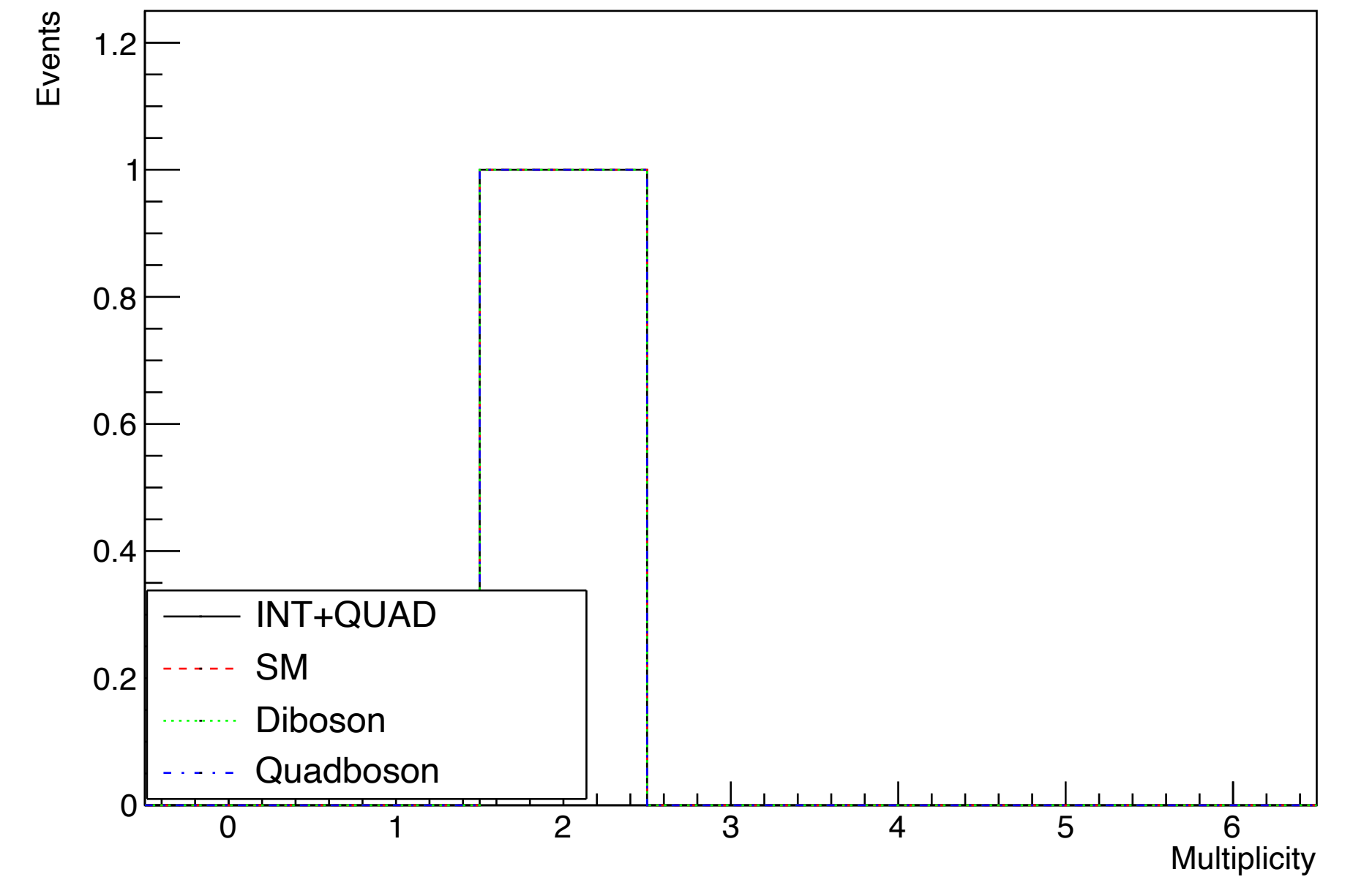

INT+QUAD

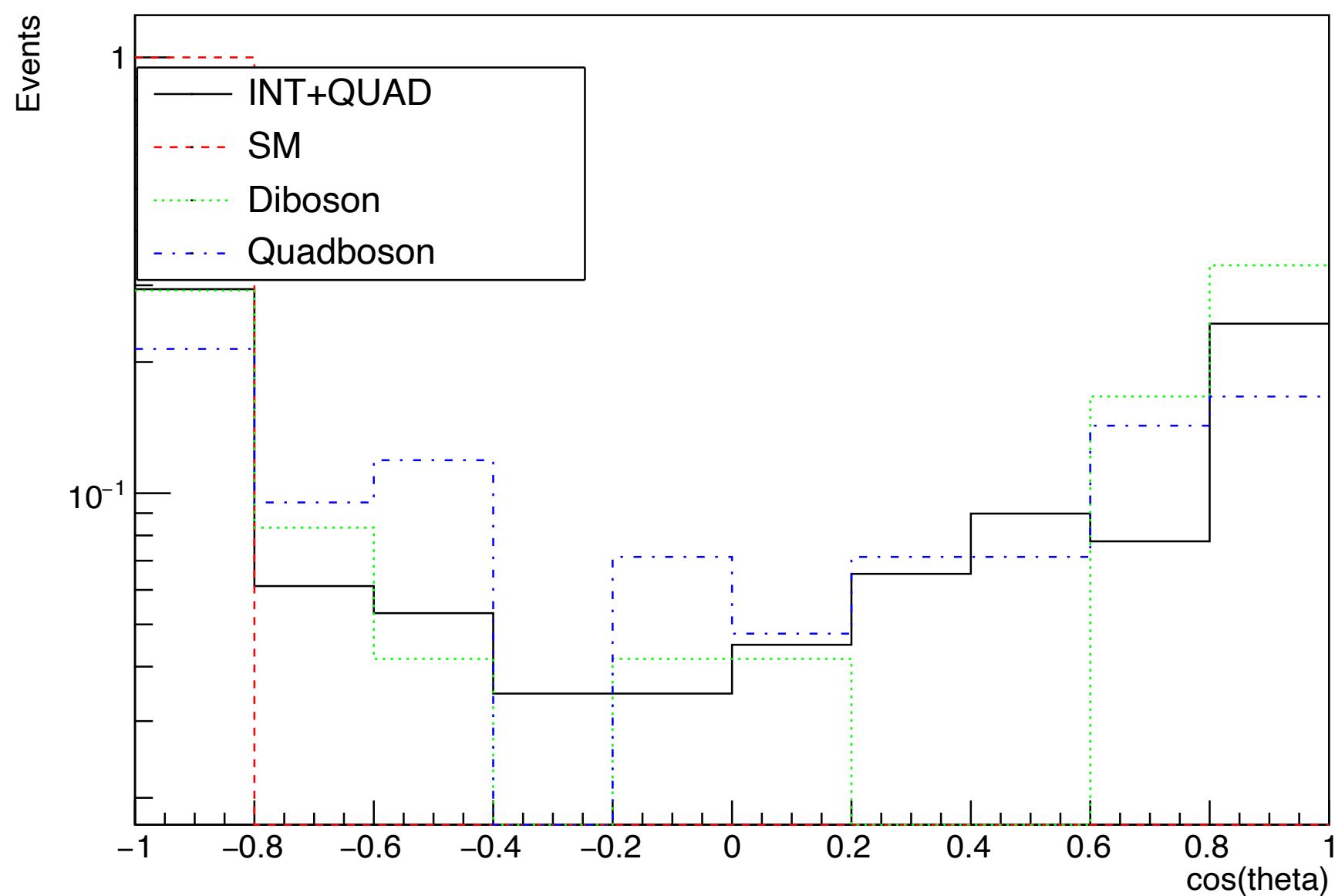

All plots at 6 TeV
 2 muons and 2 W-jets required
 $|\text{mass}(\text{mumu})-91|>15$
 Reconstructed Muons
 Leading in momentum (top)
 Sub-leading (bottom)

INT+QUAD

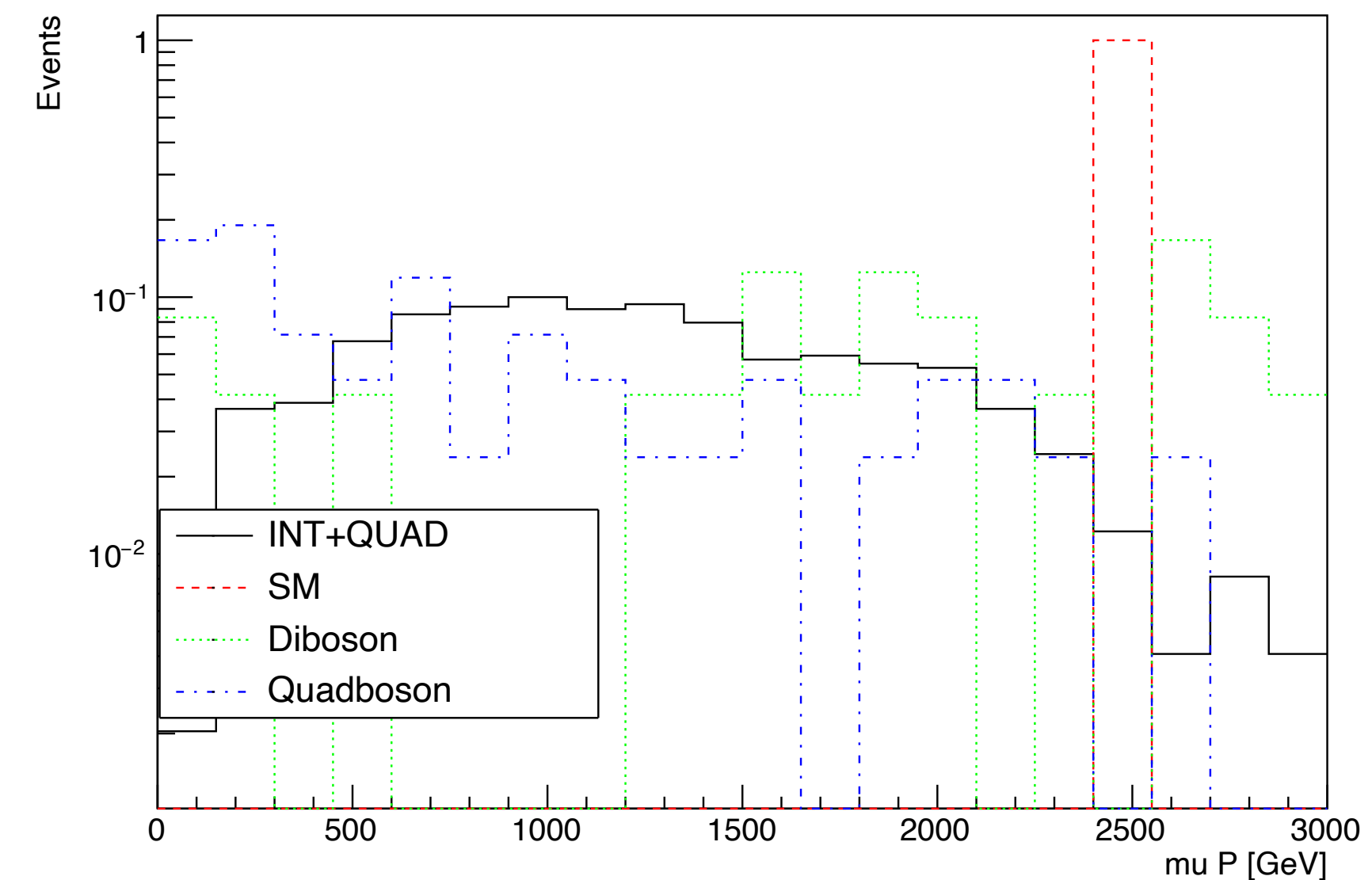

INT+QUAD

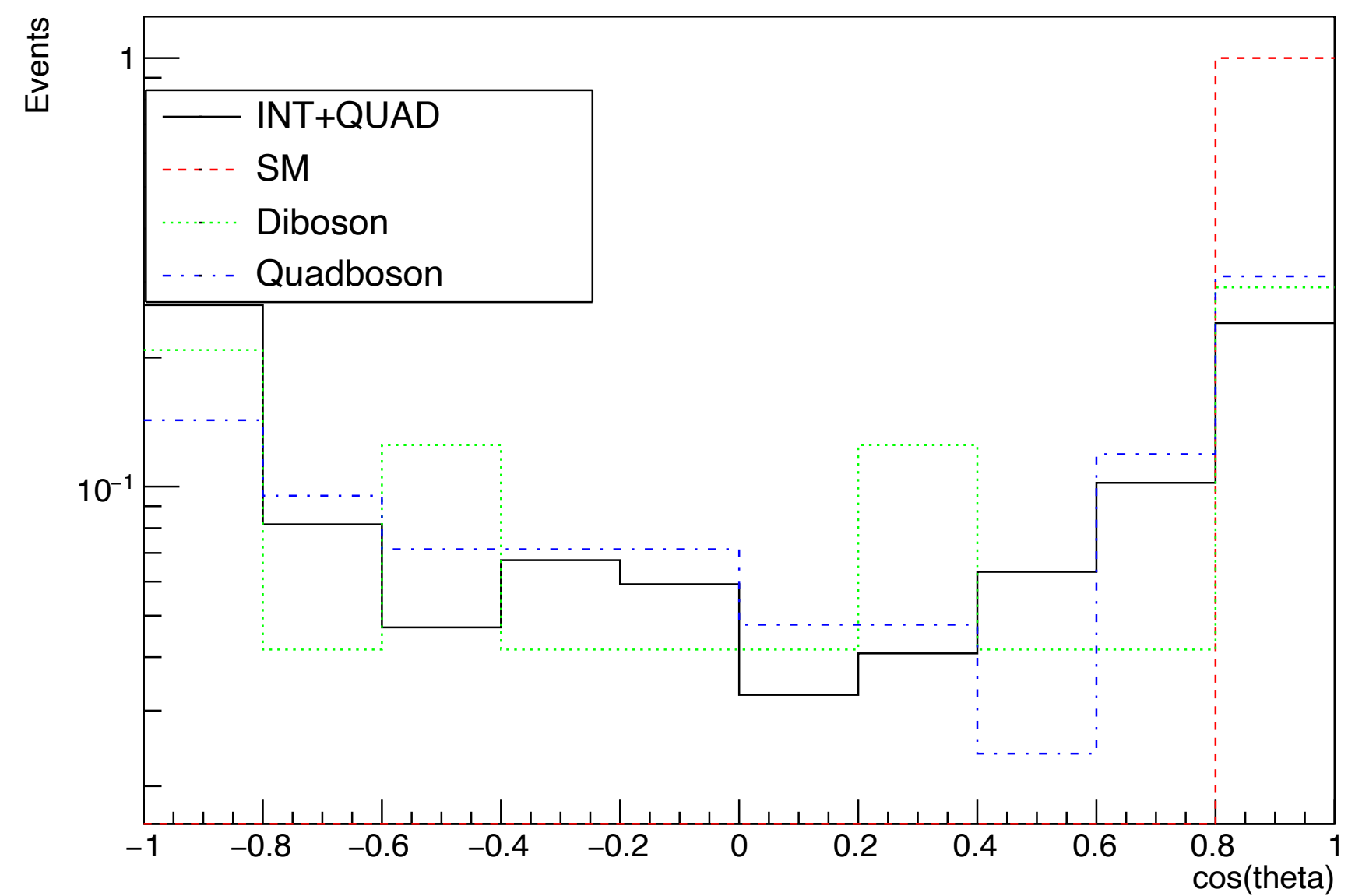

INT+QUAD

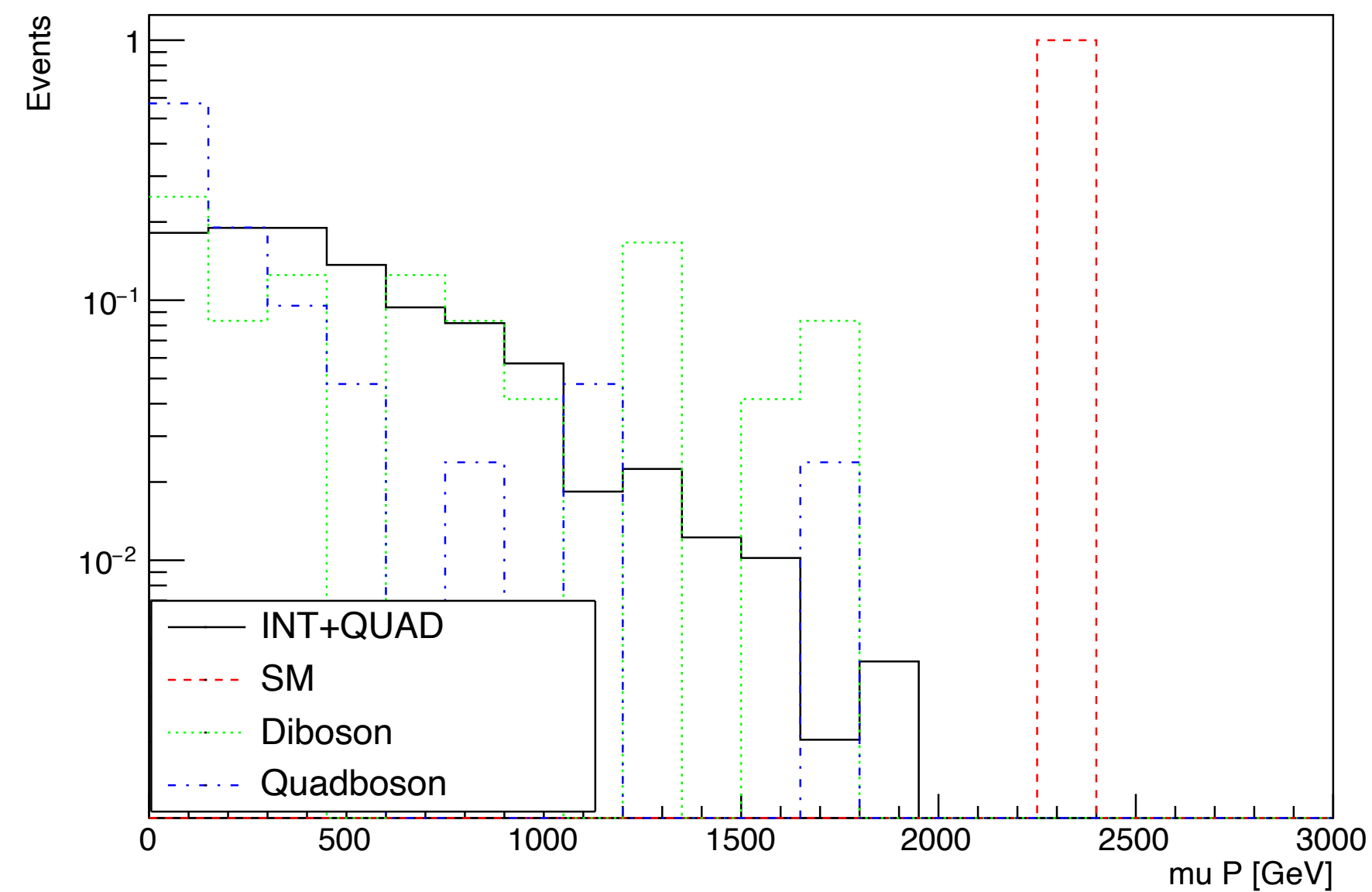

INT+QUAD

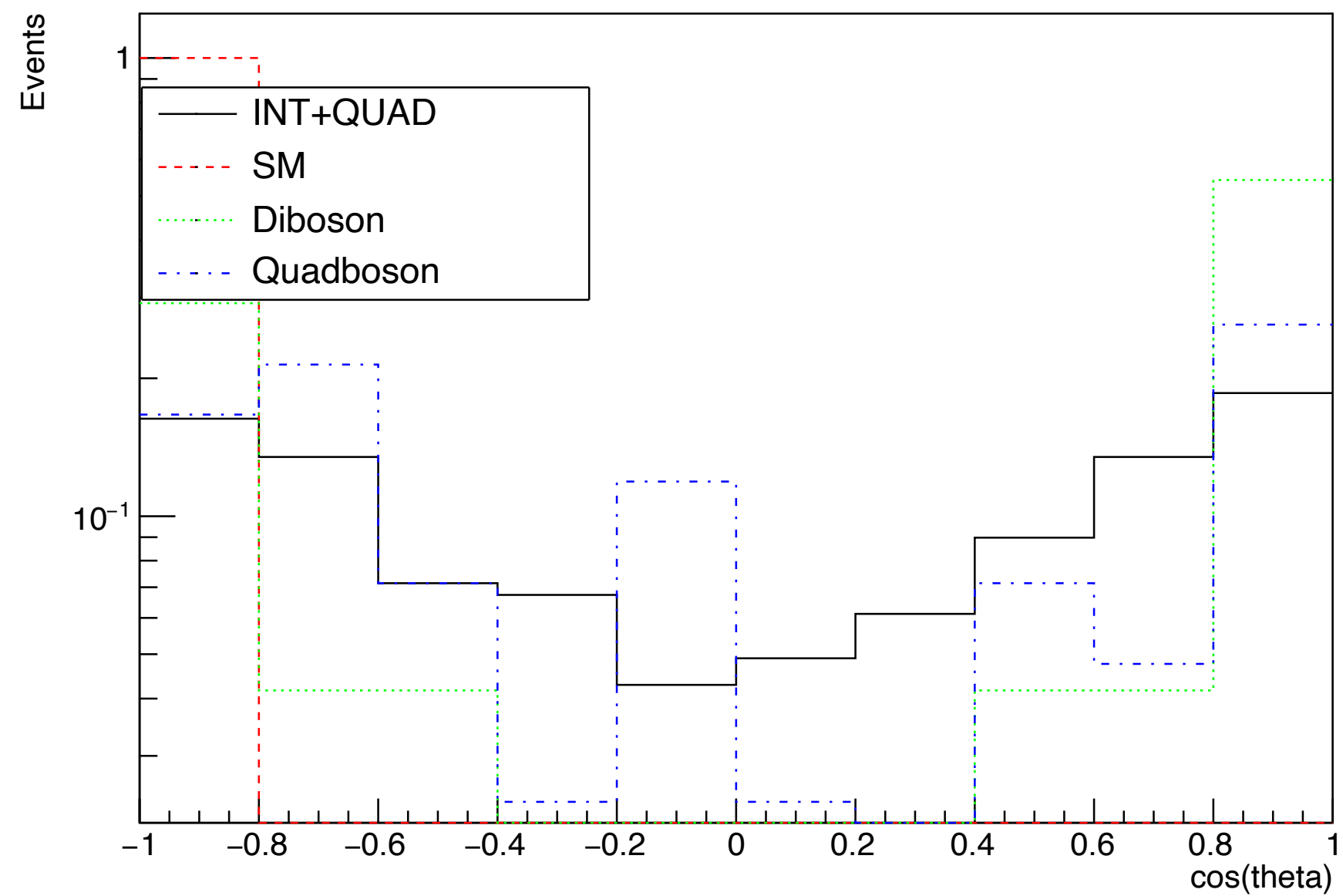

All plots at 6 TeV
 2 muons and 2 W-jets required
 $|\text{mass}(\text{mumu})-91|>15$
 W-jets ($50<\text{mass}<100$)
 Leading in momentum (top)
 Sub-leading (bottom)

INT+QUAD

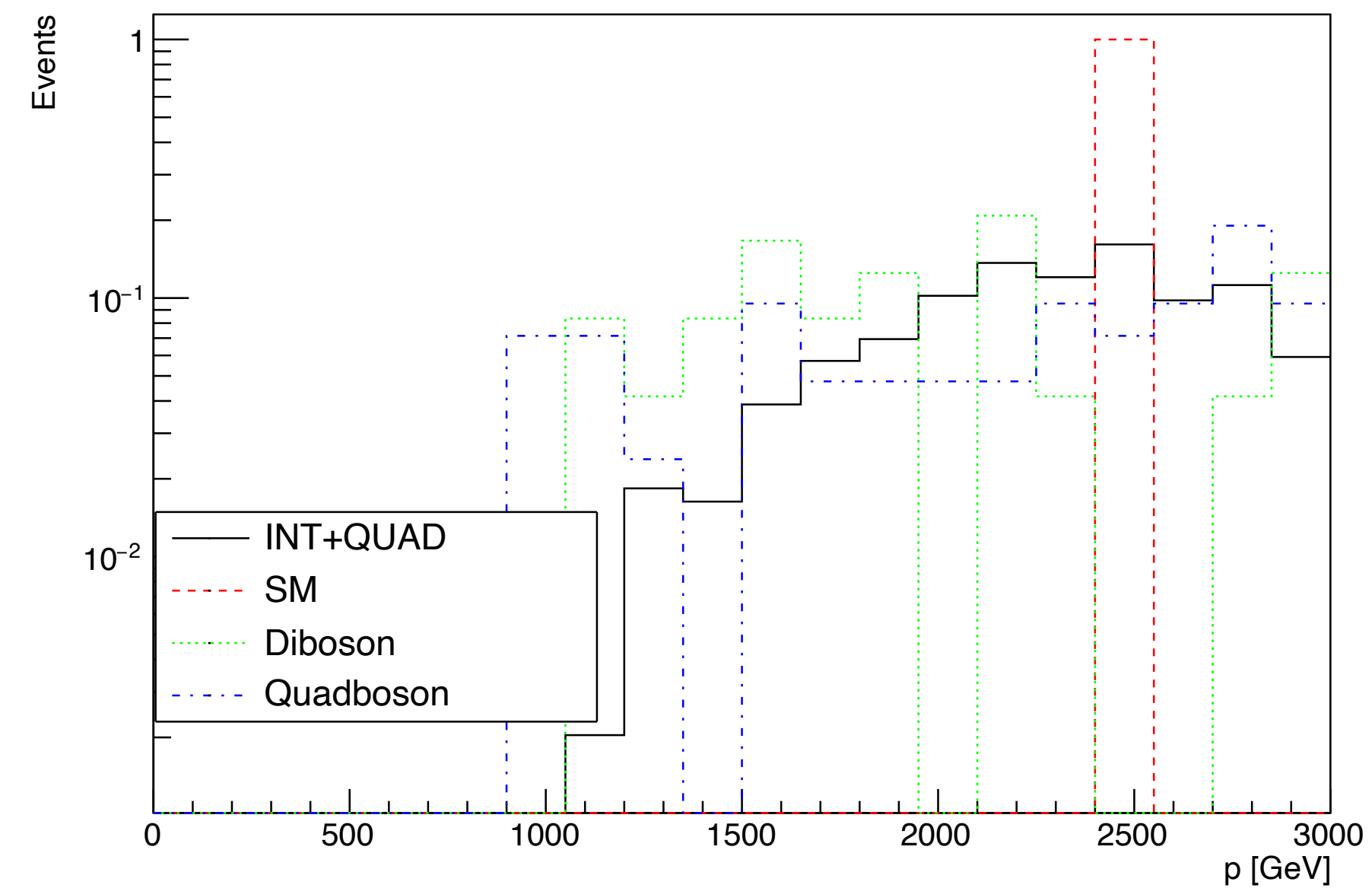

INT+QUAD

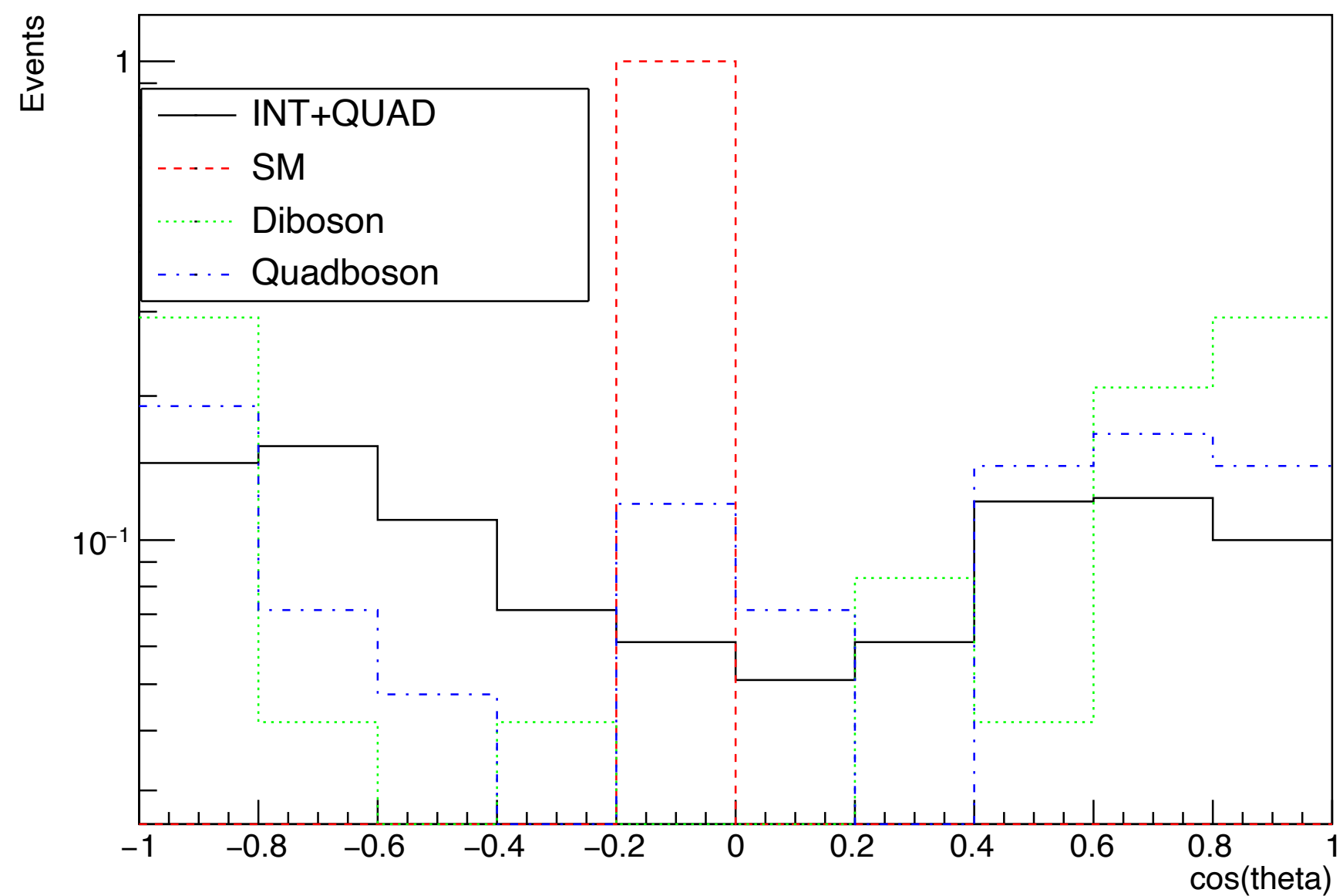

INT+QUAD

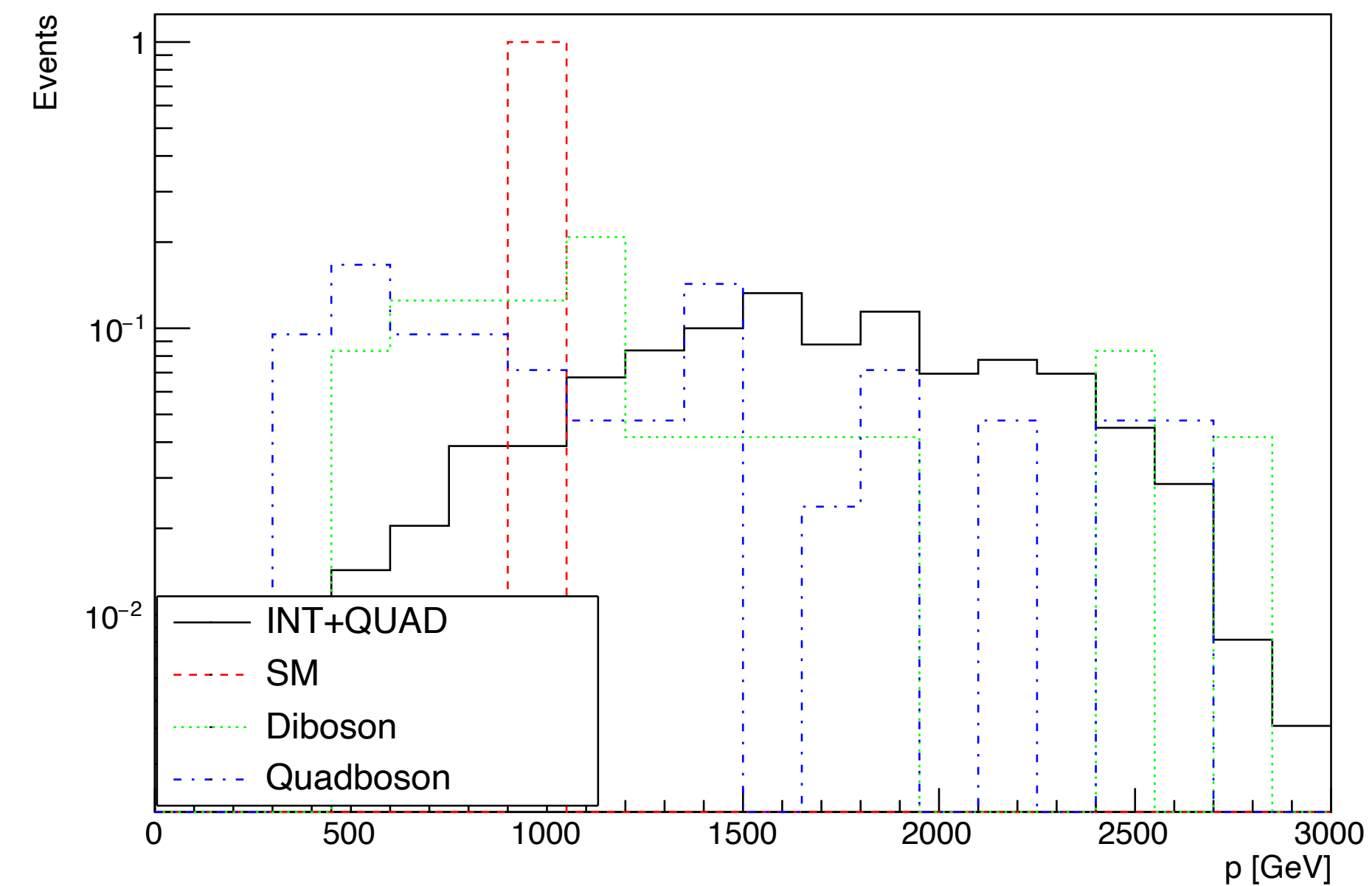

INT+QUAD

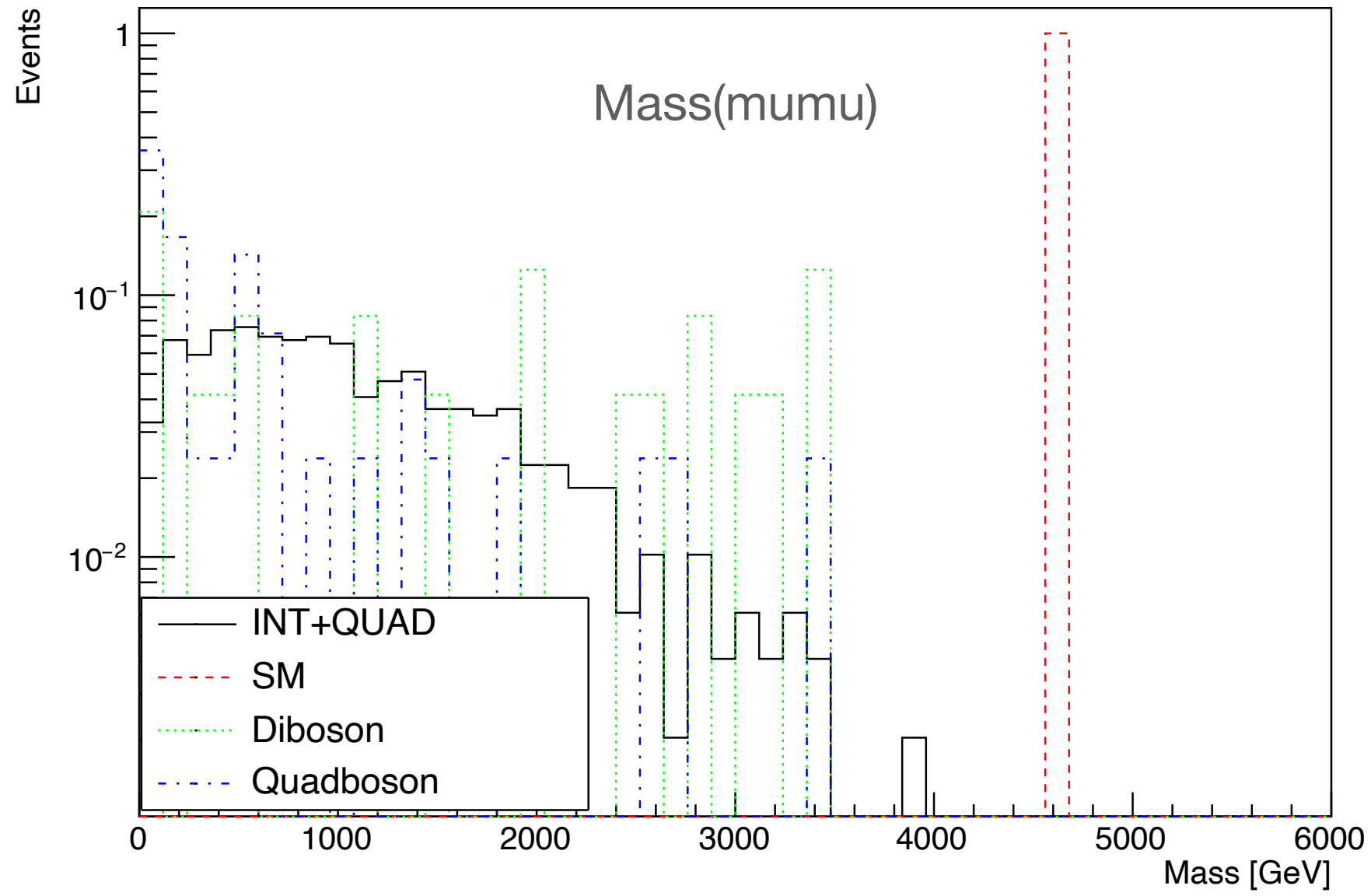

All plots at 6 TeV
2 muons and 2 W-jets required
 $|\text{mass}(\text{mumu}) - 91| > 15$
Muons(left) W-jets (right)

INT+QUAD

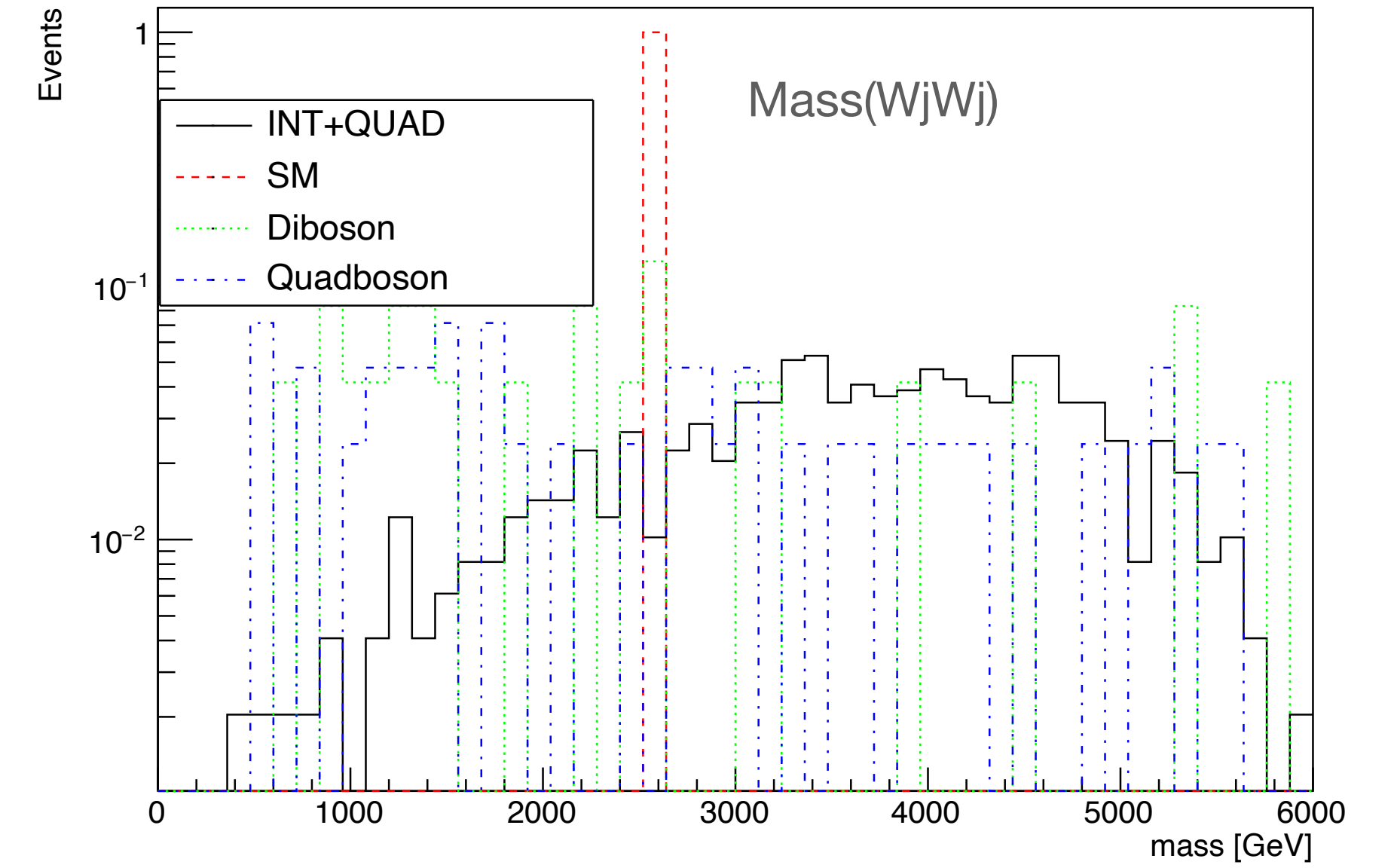

INT+QUAD

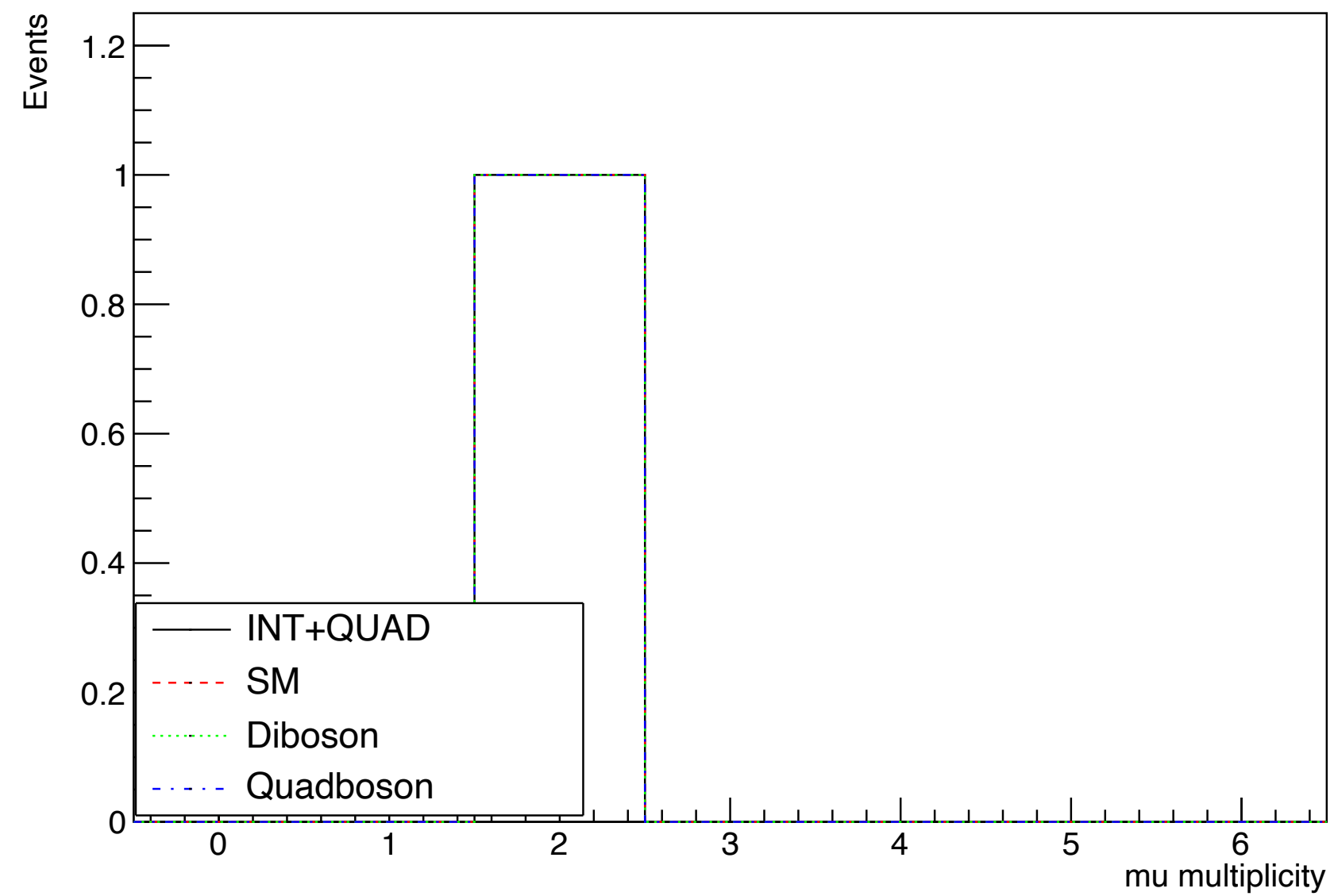

INT+QUAD

