

08. Equations of Motion including Acceleration, Space-Charge, Bending, and Momentum Spread*

Prof. Steven M. Lund

Physics and Astronomy Department
Facility for Rare Isotope Beams (FRIB)
Michigan State University (MSU)

US Particle Accelerator School
“Accelerator Physics”

Steven M. Lund and Yue Hao

East Lansing, Michigan, Kellogg Center
4-15 June, 2018
(Version 20180613)

* Research supported by:

FRIB/MSU: U.S. Department of Energy Office of Science Cooperative Agreement DE-SC0000661 and National Science Foundation Grant No. PHY-1102511

S1: Particle Equations of Motion

S1A: Introduction: The Lorentz Force Equation

The *Lorentz force equation* of a charged particle is given by (MKS Units):

$$\frac{d}{dt} \mathbf{p}_i(t) = q_i [\mathbf{E}(\mathbf{x}_i, t) + \mathbf{v}_i(t) \times \mathbf{B}(\mathbf{x}_i, t)]$$

m_i, q_i particle mass, charge $i =$ particle index

$\mathbf{x}_i(t)$ particle coordinate $t =$ time

$\mathbf{p}_i(t) = m_i \gamma_i(t) \mathbf{v}_i(t)$ particle momentum

$\mathbf{v}_i(t) = \frac{d}{dt} \mathbf{x}_i(t) = c \vec{\beta}_i(t)$ particle velocity

$\gamma_i(t) = \frac{1}{\sqrt{1 - \beta_i^2(t)}}$ particle gamma factor

| | <u>Total</u> | = | <u>Applied</u> | + | <u>Self</u> |
|-----------------|-----------------------------|---|-------------------------------|---|-------------------------------|
| Electric Field: | $\mathbf{E}(\mathbf{x}, t)$ | | $\mathbf{E}^a(\mathbf{x}, t)$ | | $\mathbf{E}^s(\mathbf{x}, t)$ |
| Magnetic Field: | $\mathbf{B}(\mathbf{x}, t)$ | | $\mathbf{B}^a(\mathbf{x}, t)$ | | $\mathbf{B}^s(\mathbf{x}, t)$ |

S1B: Applied Fields used to Focus, Bend, and Accelerate Beam

Transverse optics for focusing:

Electric Quadrupole

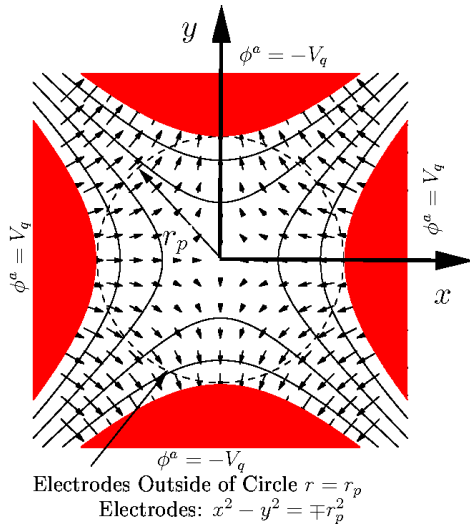

Magnetic Quadrupole

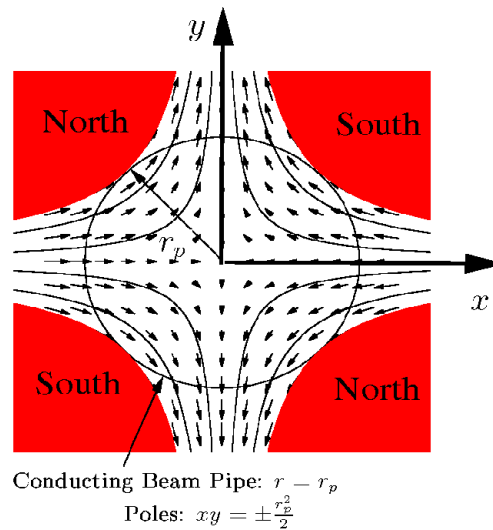

Solenoid

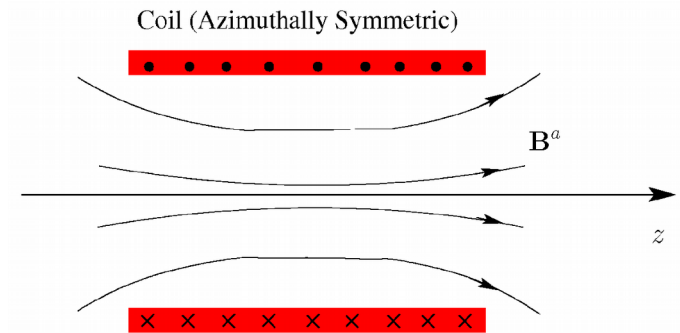

Dipole Bends:

Electric x-direction bend

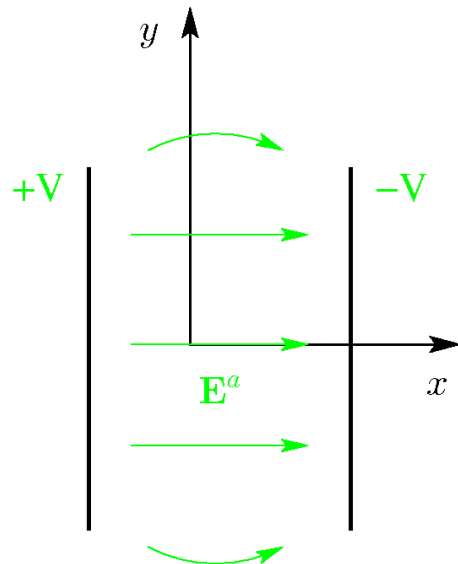

Magnetic x-direction bend

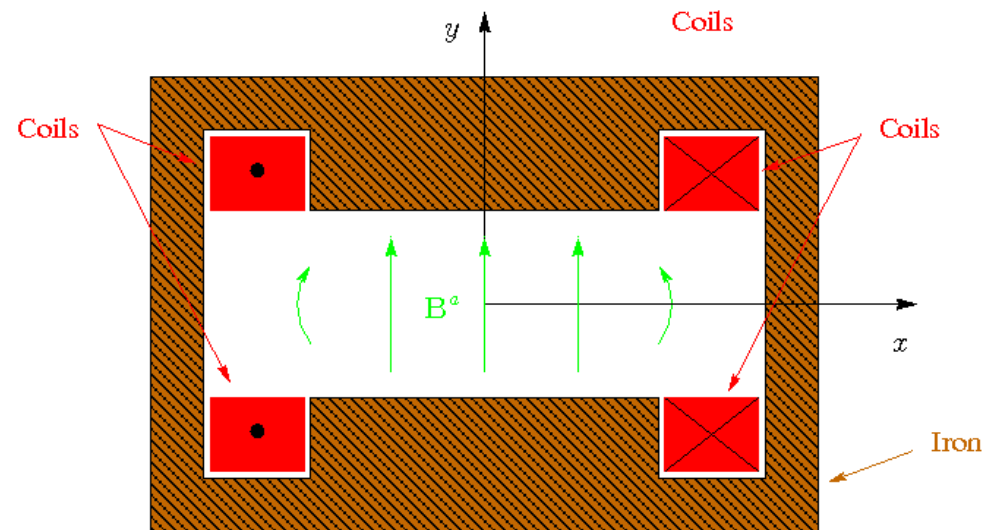

Longitudinal Acceleration:

RF Cavity

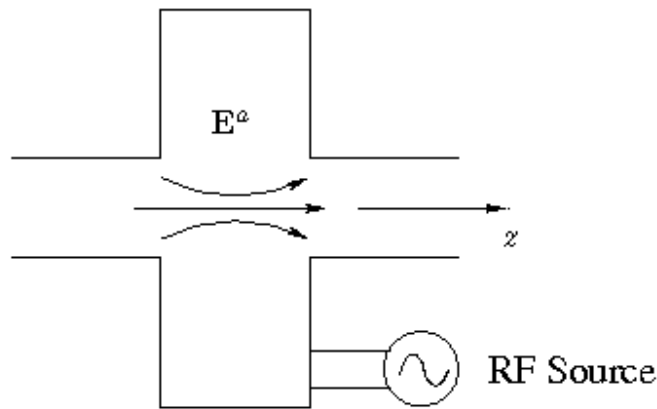

Induction Cell

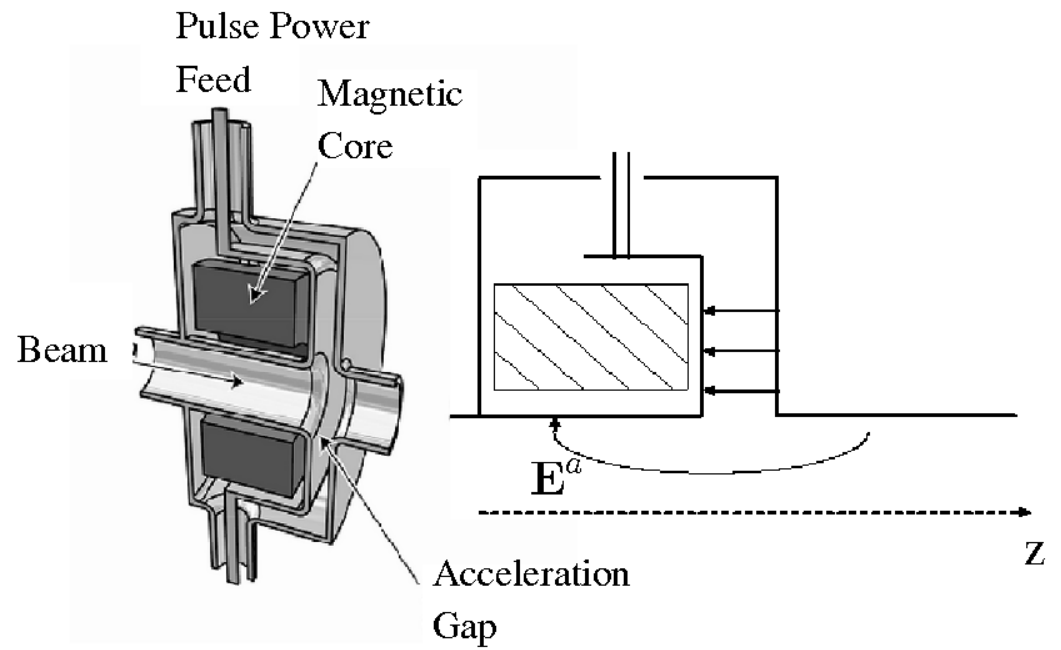

We will cover primarily transverse dynamics. Later lectures will cover acceleration and longitudinal physics:

- ◆ Acceleration influences transverse dynamics – not possible to fully decouple

S1C: Machine Lattice

Applied field structures are often arranged in a regular (periodic) lattice for beam transport/acceleration:

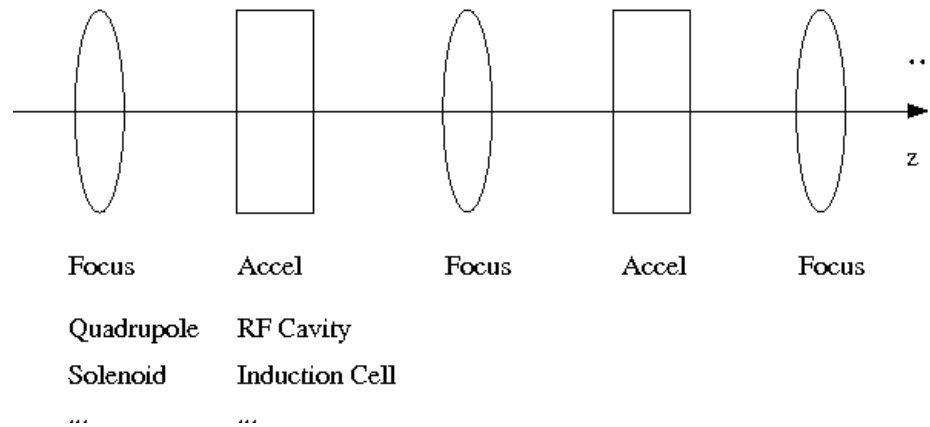

- ▶ Sometimes functions like bending/focusing are combined into a single element

Example – Linear FODO lattice (symmetric quadrupole doublet)

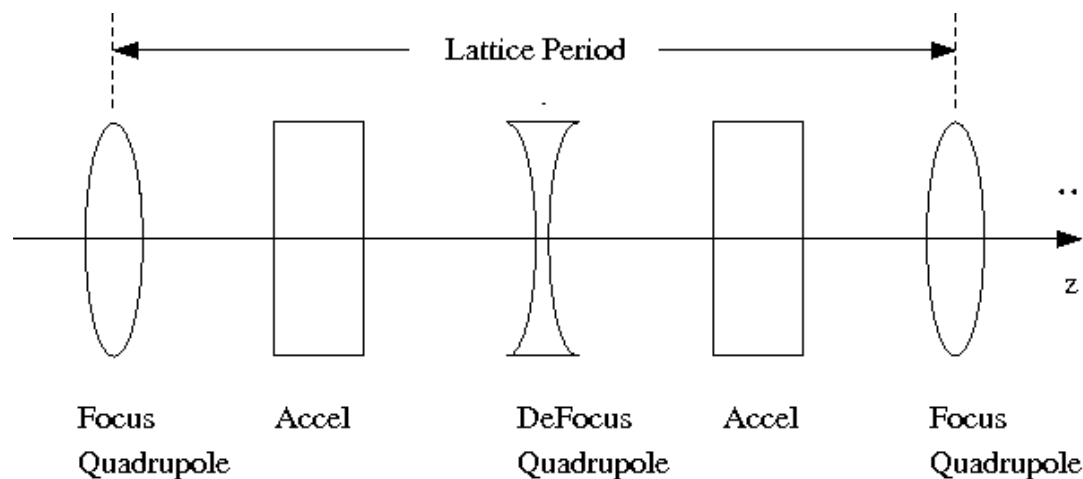

Lattices for rings and some beam insertion/extraction sections also incorporate bends and more complicated periodic structures:

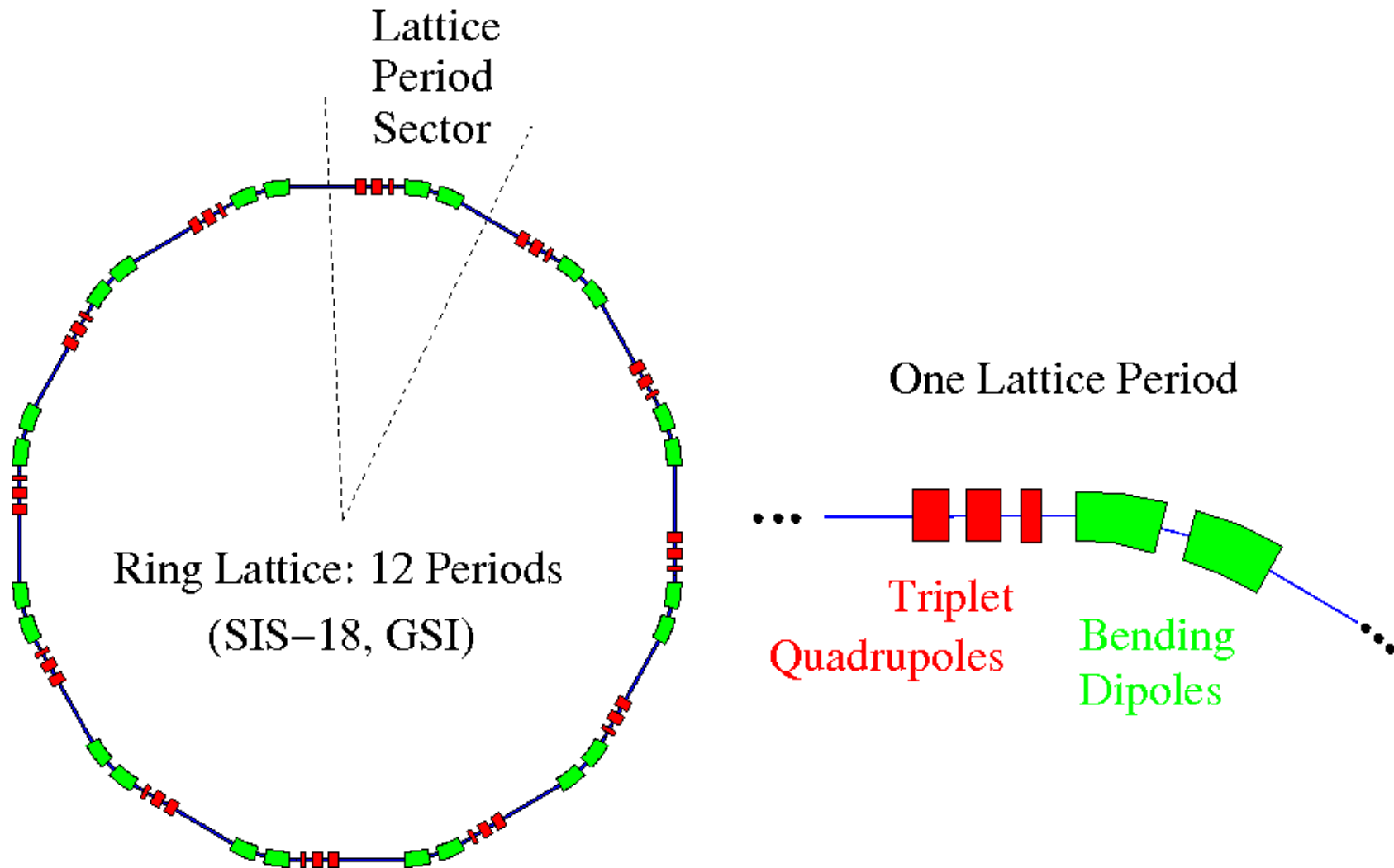

- ◆ Elements to insert beam into and out of ring further complicate lattice
- ◆ Acceleration cells also present
(typically several RF cavities at one or more location)

S1D: Self fields

Self-fields are generated by the distribution of beam particles:

Charges

Currents

Particle at Rest

(pure electrostatic)

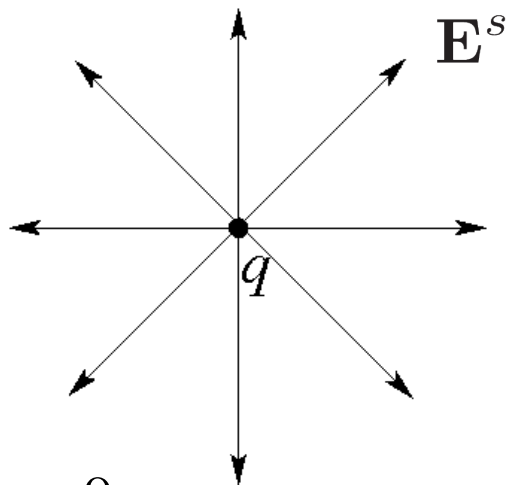

$$\mathbf{B}^s = 0$$

- ◆ Superimpose for all particles in the beam distribution
- ◆ Accelerating particles also radiate
 - We neglect electromagnetic radiation here
 - Relevant in parts covering Synchrotron Radiation and FELs

Particle in Motion

Obtain from
Lorentz boost
of rest-frame field:
see Jackson,
*Classical
Electrodynamics*

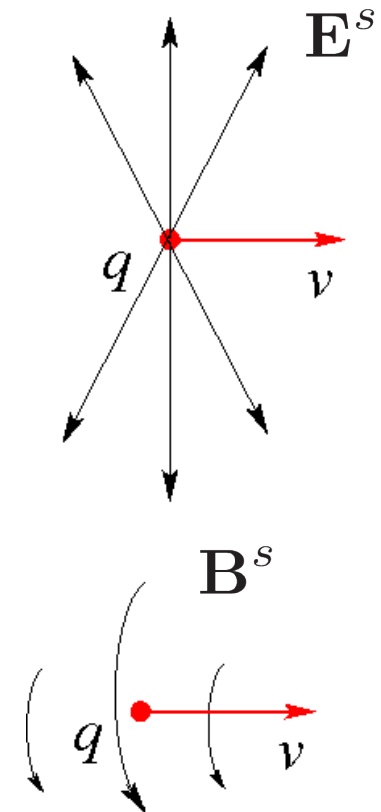

The electric (\mathbf{E}^a) and magnetic (\mathbf{B}^a) fields satisfy the **Maxwell Equations**. The linear structure of the Maxwell equations can be exploited to resolve the field into **Applied** and **Self-Field** components:

$$\mathbf{E} = \mathbf{E}^a + \mathbf{E}^s$$

$$\mathbf{B} = \mathbf{B}^a + \mathbf{B}^s$$

Applied Fields (often quasi-static $\partial/\partial t \simeq 0$) $\mathbf{E}^a, \mathbf{B}^a$

Generated by elements in lattice

$$\begin{aligned} \nabla \cdot \mathbf{E}^a &= \frac{\rho^a}{\epsilon_0} & \nabla \times \mathbf{B}^a &= \mu_0 \mathbf{J}^a + \frac{1}{c^2} \frac{\partial}{\partial t} \mathbf{E}^a \\ \nabla \times \mathbf{E}^a &= -\frac{\partial}{\partial t} \mathbf{B}^a & \nabla \cdot \mathbf{B}^a &= 0 \end{aligned}$$

$$\begin{aligned} \rho^a &= \text{applied charge density} & \frac{1}{\mu_0 \epsilon_0} &= c^2 \\ \mathbf{J}^a &= \text{applied current density} \end{aligned}$$

+ Boundary Conditions on \mathbf{E}^a and \mathbf{B}^a

- ◆ Boundary conditions depend on the total fields \mathbf{E}, \mathbf{B} and if separated into Applied and Self-Field components, care can be required
- ◆ System often solved as static boundary value problem and source free in the vacuum transport region of the beam

/// Aside: Notation:

$$\nabla \equiv \hat{\mathbf{x}} \frac{\partial}{\partial x} + \hat{\mathbf{y}} \frac{\partial}{\partial y} + \hat{\mathbf{z}} \frac{\partial}{\partial z}$$

$$= \hat{\mathbf{r}} \frac{\partial}{\partial r} + \frac{\hat{\theta}}{r} \frac{\partial}{\partial \theta} + \hat{\mathbf{z}} \frac{\partial}{\partial z}$$

$$= \frac{\partial}{\partial \mathbf{x}}$$

$$= \frac{\partial}{\partial \mathbf{x}_{\perp}} + \hat{\mathbf{z}} \frac{\partial}{\partial z}$$

$$\mathbf{x} = \hat{\mathbf{x}}x + \hat{\mathbf{y}}y + \hat{\mathbf{z}}z$$

$$= \mathbf{x}_{\perp} + \hat{\mathbf{z}}z$$

$$\mathbf{x}_{\perp} \equiv \hat{\mathbf{x}}x + \hat{\mathbf{y}}y$$

In integrals, we denote:

$$\int d^3x \cdots = \int_{-\infty}^{\infty} dx \int_{-\infty}^{\infty} dy \int_{-\infty}^{\infty} dz \cdots = \int d^2x_{\perp} \int_{-\infty}^{\infty} dz \cdots$$

$$\int d^2x_{\perp} \cdots = \int_{-\infty}^{\infty} dx \int_{-\infty}^{\infty} dy \cdots = \int_0^{\infty} dr r \int_{-\pi}^{\pi} d\theta \cdots$$

- Cartesian Representation

- Cylindrical Representation

$$x = r \cos \theta$$

$$\hat{\mathbf{r}} = \hat{\mathbf{x}} \cos \theta + \hat{\mathbf{y}} \sin \theta$$

$$y = r \sin \theta$$

$$\hat{\theta} = -\hat{\mathbf{x}} \sin \theta + \hat{\mathbf{y}} \cos \theta$$

- Abbreviated Representation

- Resolved Abbreviated Representation

Resolved into Perpendicular (\perp)
and Parallel (z) components

Self-Fields (dynamic, evolve with beam)

Generated by particle of the beam rather than (applied) sources outside beam

$$\nabla \cdot \mathbf{E}^s = \frac{\rho^s}{\epsilon_0} \qquad \nabla \times \mathbf{B}^s = \mu_0 \mathbf{J}^s + \frac{1}{c^2} \frac{\partial}{\partial t} \mathbf{E}^s$$

$$\nabla \times \mathbf{E}^s = -\frac{\partial}{\partial t} \mathbf{B}^s \qquad \nabla \cdot \mathbf{B}^s = 0$$

ρ^s = beam charge density

$$= \sum_{i=1}^N q_i \delta[\mathbf{x} - \mathbf{x}_i(t)]$$

\mathbf{J}^s = beam current density

$$= \sum_{i=1}^N q_i \mathbf{v}_i(t) \delta[\mathbf{x} - \mathbf{x}_i(t)]$$

i = particle index
(N particles)

q_i = particle charge

\mathbf{x}_i = particle coordinate

\mathbf{v}_i = particle velocity

$$\delta(\mathbf{x}) \equiv \delta(x)\delta(y)\delta(z)$$

$\delta(x)$ \equiv Dirac-delta function

$$\sum_{i=1}^N \dots = \text{sum over beam particles}$$

+ Boundary Conditions on \mathbf{E}^s and \mathbf{B}^s
from material structures, radiation conditions, etc.

In accelerators, typically there is ideally a **single species of particle**:

$$\begin{aligned} q_i &\rightarrow q \\ m_i &\rightarrow m \end{aligned}$$

Large Simplification!

Multi-species results in more complex collective effects

Motion of particles within axial slices of the “bunch” are **highly directed**:

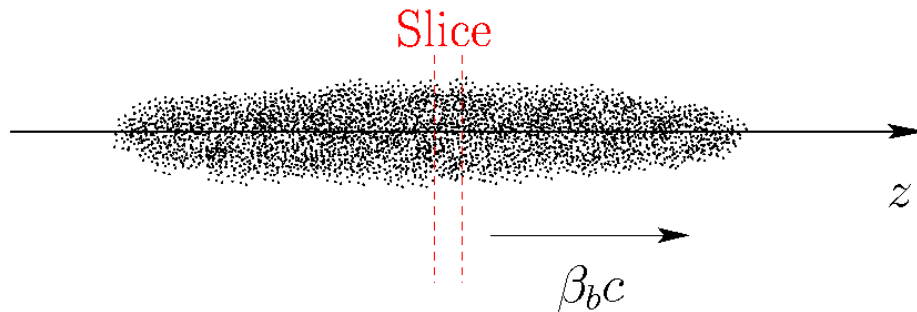

$$\begin{aligned} \beta_b(z)c &\equiv \frac{1}{N'} \sum_{i=1}^{N'} \mathbf{v}_i \cdot \hat{\mathbf{z}} \\ &= \text{Mean axial velocity of } N' \text{ particles in beam slice} \end{aligned}$$

$$\frac{d}{dt} \mathbf{x}_i(t) = \mathbf{v}_i(t) = \hat{\mathbf{z}} \beta_b(z)c + \delta \mathbf{v}_i$$

$$|\delta \mathbf{v}_i| \ll |\beta_b|c \quad \text{Paraxial Approximation}$$

There are typically **many particles**:

$$\begin{aligned} \rho^s &= \sum_{i=1}^N q_i \delta[\mathbf{x} - \mathbf{x}_i(t)] \\ &\simeq \rho(\mathbf{x}, t) \quad \text{continuous charge-density} \end{aligned} \quad \begin{aligned} \mathbf{J}^s &= \sum_{i=1}^N q_i \mathbf{v}_i(t) \delta[\mathbf{x} - \mathbf{x}_i(t)] \\ &\simeq \beta_b c \rho(\mathbf{x}, t) \hat{\mathbf{z}} \quad \text{continuous axial current-density} \end{aligned}$$

The beam evolution is typically **sufficiently slow** (for heavy ions) where we can **neglect radiation** and approximate the self-field Maxwell Equations as:

See: **Appendix B, Magnetic Self-Fields**

$$\begin{aligned} \mathbf{E}^s &= -\nabla\phi \\ \mathbf{B}^s &= \nabla \times \mathbf{A} & \mathbf{A} &= \hat{\mathbf{z}} \frac{\beta_b}{c} \phi \\ \nabla^2 \phi &= \frac{\partial}{\partial \mathbf{x}} \cdot \frac{\partial}{\partial \mathbf{x}} \phi = -\frac{\rho^s}{\epsilon_0} \\ &+ \text{Boundary Conditions on } \phi \end{aligned}$$

Vast Reduction of self-field model:

Approximation equiv to electrostatic interactions in frame moving with beam: see **Appendix B**

But still complicated

Resolve the **Lorentz force** acting on beam particles into **Applied** and **Self-Field** terms:

$$\mathbf{F}_i(\mathbf{x}_i, t) = q\mathbf{E}(\mathbf{x}_i, t) + q\mathbf{v}_i(t) \times \mathbf{B}(\mathbf{x}_i, t)$$

$$\mathbf{F}_i = \mathbf{F}_i^a + \mathbf{F}_i^s$$

$$\mathbf{E} = \mathbf{E}^a + \mathbf{E}^s$$

$$\mathbf{B} = \mathbf{B}^a + \mathbf{B}^s$$

Applied:

$$\mathbf{F}_i^a = q\mathbf{E}_i^a + q\mathbf{v}_i \times \mathbf{B}_i^a$$

Self-Field:

$$\mathbf{F}_i^s = q\mathbf{E}_i^s + q\mathbf{v}_i \times \mathbf{B}_i^s$$

$$\mathbf{E}^a(\mathbf{x}_i, t) \equiv \mathbf{E}_i^a \text{ etc.}$$

The self-field force can be simplified:

Plug in self-field forms:

$$\mathbf{F}_i^s = q\mathbf{E}_i^s + q\mathbf{v}_i \times \mathbf{B}_i^s \quad \dots \Big|_i \equiv \dots \Big|_{\mathbf{x}=\mathbf{x}_i}$$

$$\simeq q \left[-\frac{\partial\phi}{\partial\mathbf{x}} \Big|_i + (\beta_b c \hat{\mathbf{z}} + \delta\mathbf{v}_i) \times \left(\frac{\partial}{\partial\mathbf{x}} \times \hat{\mathbf{z}} \frac{\beta_b}{c} \phi \right) \Big|_i \right]$$

~0 Neglect: Paraxial

Resolve into transverse (x and y) and longitudinal (z) components and simplify:

$$\begin{aligned} \beta_b c \hat{\mathbf{z}} \times \left(\frac{\partial}{\partial\mathbf{x}} \times \hat{\mathbf{z}} \frac{\beta_b}{c} \phi \right) \Big|_i &= \beta_b^2 \hat{\mathbf{z}} \times \left(\frac{\partial}{\partial\mathbf{x}_\perp} \times \hat{\mathbf{z}} \phi \right) \Big|_i \\ &= \beta_b^2 \hat{\mathbf{z}} \times \left(\frac{\partial\phi}{\partial y} \hat{\mathbf{x}} - \frac{\partial\phi}{\partial x} \hat{\mathbf{y}} \right) \Big|_i \\ &= \beta_b^2 \left(\frac{\partial\phi}{\partial x} \hat{\mathbf{x}} + \frac{\partial\phi}{\partial y} \hat{\mathbf{y}} \right) \Big|_i \\ &= \beta_b^2 \frac{\partial\phi}{\partial\mathbf{x}_\perp} \Big|_i \end{aligned}$$

also

$$-\frac{\partial\phi}{\partial\mathbf{x}}\Big|_i = -\frac{\partial\phi}{\partial\mathbf{x}_\perp}\Big|_i - \frac{\partial\phi}{\partial z}\Big|_i \hat{\mathbf{z}}$$

Together, these results give:

$$\mathbf{F}_i^s = \left[-\frac{q}{\gamma_b^2} \frac{\partial\phi}{\partial\mathbf{x}_\perp}\Big|_i \right] \left[-\hat{\mathbf{z}} q \frac{\partial\phi}{\partial z}\Big|_i \right]$$

Transverse

Longitudinal

$$\gamma_b \equiv \frac{1}{\sqrt{1 - \beta_b^2}}$$

Axial relativistic gamma of beam

- Transverse and longitudinal forces have different axial gamma factors
- $1/\gamma_b^2$ factor in transverse force shows the space-charge forces become weaker as axial beam kinetic energy increases
 - Most important in low energy (nonrelativistic) beam transport
 - Strong in/near injectors before much acceleration

/// Aside: Singular Self Fields

In *free space*, the beam potential generated from the singular charge density:

$$\rho^s = \sum_{i=1}^N q_i \delta[\mathbf{x} - \mathbf{x}_i(t)]$$

is

$$\phi(\mathbf{x}) = \frac{q}{4\pi\epsilon_0} \sum_{i=1}^N \frac{1}{|\mathbf{x} - \mathbf{x}_i|}$$

Thus, the force of a particle at $\mathbf{x} = \mathbf{x}_i$ is:

$$\mathbf{F}_i = -q \left. \frac{\partial \phi}{\partial \mathbf{x}} \right|_i = \frac{q^2}{4\pi\epsilon_0} \sum_{j=1}^N \frac{(\mathbf{x}_i - \mathbf{x}_j)}{|\mathbf{x}_i - \mathbf{x}_j|^{3/2}}$$

Which diverges due to the $i = j$ term. This divergence is essentially “erased” when the continuous charge density is applied:

$$\rho^s = \sum_{i=1}^N q_i \delta[\mathbf{x} - \mathbf{x}_i(t)] \longrightarrow \rho(\mathbf{x}, t)$$

Effectively removes effect of collisions

- Find collisionless Vlasov model of evolution is often adequate

///

The particle equations of motion in $\mathbf{x}_i - \mathbf{v}_i$ phase-space variables become:

◆ Separate parts of $q\mathbf{E}_i^a + q\mathbf{v}_i \times \mathbf{B}_i^a$ into transverse and longitudinal comp
Transverse

$$\frac{d}{dt}\mathbf{x}_{\perp i} = \mathbf{v}_{\perp i}$$

$$\frac{d}{dt}(m\gamma_i\mathbf{v}_{\perp i}) \simeq \underbrace{q\mathbf{E}_{\perp i}^a + q\beta_b c\hat{\mathbf{z}} \times \mathbf{B}_{\perp i}^a + qB_{zi}^a\mathbf{v}_{\perp i} \times \hat{\mathbf{z}}}_{\text{Applied}} - q \underbrace{\frac{1}{\gamma_b^2} \frac{\partial\phi}{\partial\mathbf{x}_{\perp}} \Big|_i}_{\text{Self}}$$

Longitudinal

$$\frac{d}{dt}z_i = v_{zi}$$

$$\frac{d}{dt}(m\gamma_i v_{zi}) \simeq \underbrace{qE_{zi}^a - q(v_{xi}B_{yi}^a - v_{yi}B_{xi}^a)}_{\text{Applied}} - q \underbrace{\frac{\partial\phi}{\partial z} \Big|_i}_{\text{Self}}$$

In the remainder of this (and most other) lectures, we analyze **Transverse Dynamics**. **Longitudinal Dynamics** will be covered in future lectures

- ◆ Except near injector, acceleration is typically slow
 - Fractional change in γ_b, β_b small over characteristic transverse dynamical scales such as lattice period and betatron oscillation periods
- ◆ Regard γ_b, β_b as specified functions given by the “**acceleration schedule**”

S1E: Equations of Motion in s and the Paraxial Approximation

In transverse accelerator dynamics, it is convenient to employ the axial coordinate (s) of a particle in the accelerator as the **independent** variable:

- Need fields at lattice location of particle to integrate equations for particle trajectories

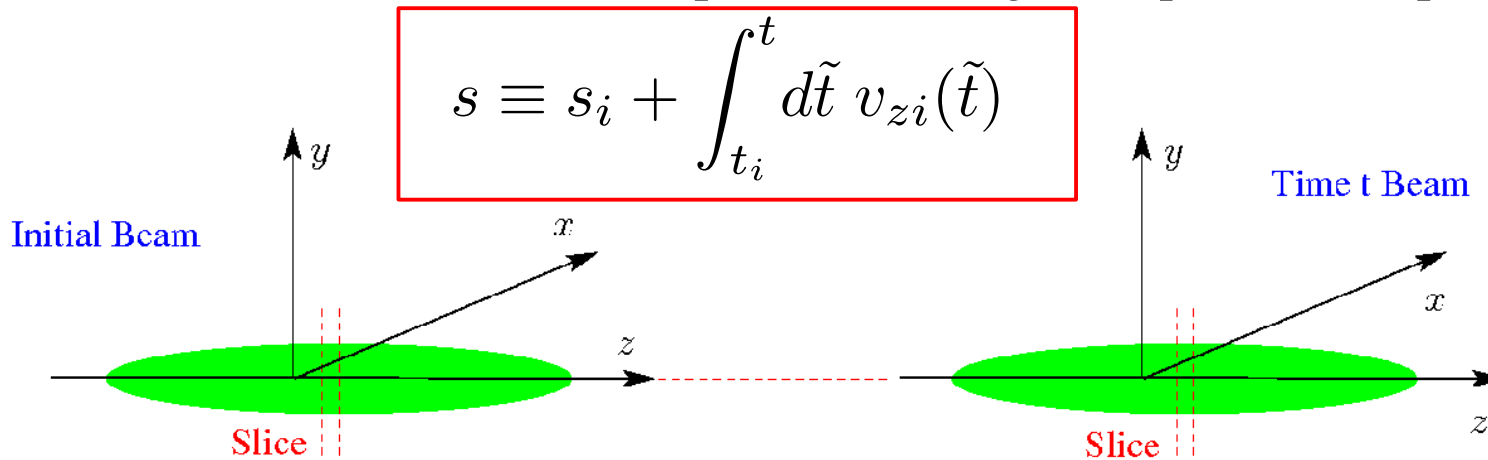

Transform:

$$\begin{aligned} t &= t_i \\ s &= s_i \end{aligned}$$

$$v_{zi} = \frac{ds}{dt} \implies v_{xi} = \frac{dx_i}{dt} = \frac{ds}{dt} \frac{dx_i}{ds} = v_{zi} \frac{dx_i}{ds} = (\beta_b c + \delta v_{zi}) \frac{dx_i}{ds}$$

Neglect

$$\simeq \beta_b c \frac{dx_i}{ds}$$

Denote:

$$' \equiv \frac{d}{ds}$$

$$v_{xi} = \frac{dx_i}{dt} \simeq \beta_b c x'_i$$

$$v_{yi} = \frac{dy_i}{dt} \simeq \beta_b c y'_i$$

Neglecting term consistent with assumption of small longitudinal momentum spread (paraxial approximation)

- Procedure becomes more complicated when bends present: see **S1H**

In the **paraxial approximation**, x' and y' can be interpreted as the (small magnitude) angles that the particles make with the longitudinal-axis:

$$x - \text{angle} = \frac{v_{xi}}{v_{zi}} \simeq \frac{v_{xi}}{\beta_b c} = x'_i$$

$$y - \text{angle} = \frac{v_{yi}}{v_{zi}} \simeq \frac{v_{yi}}{\beta_b c} = y'_i$$

Typical accel lattice values:
 $|x'| < 50 \text{ mrad}$

The angles will be *small* in the paraxial approximation:

$$v_{xi}^2, v_{yi}^2 \ll \beta_b^2 c^2 \implies x_i'^2, y_i'^2 \ll 1$$

Since the spread of axial momentum/velocities is small in the paraxial approximation, a thin axial slice of the beam maps to a thin axial slice and s can also be thought of as the axial coordinate of the slice in the accelerator lattice

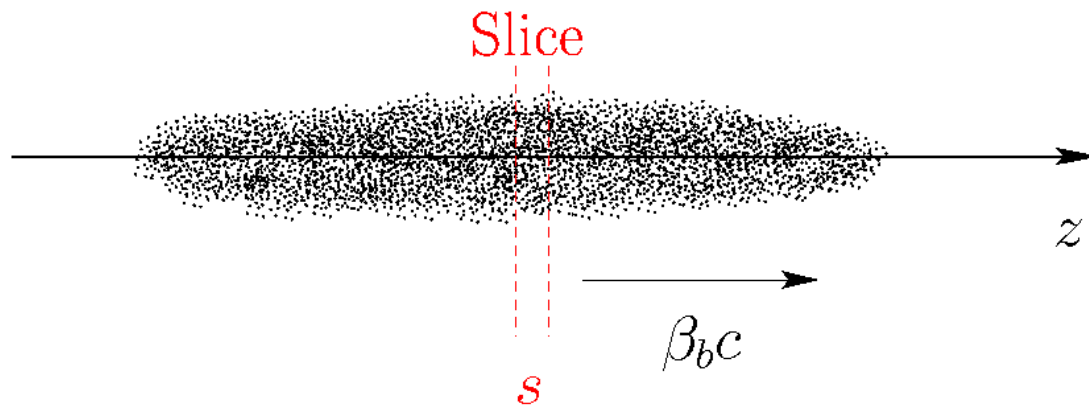

$$\beta_b \equiv \sum_{i=1}^{N'} \frac{v_{zi}}{c}$$

slice

$$s \simeq s_i + c \int_{t_i}^t d\tilde{t} \beta_b(\tilde{t})$$

$$s \simeq s_i + c \int_{t_i}^t d\tilde{t} \beta_b(\tilde{t})$$

The coordinate s can alternatively be interpreted as the axial coordinate of a reference (design) particle moving in the lattice

- ◆ Design particle has no momentum spread

It is often desirable to express the particle equations of motion in terms of s rather than the time t

- ◆ Makes it clear where you are in the lattice of the machine
- ◆ Sometimes easier to use t in codes when including many effects to high order

Transform transverse particle equations of motion to s rather than t derivatives

$$\boxed{\frac{d}{dt}(m\gamma_i \mathbf{v}_{\perp i})} \simeq q\mathbf{E}_{\perp i}^a + q\beta_b c \hat{\mathbf{z}} \times \mathbf{B}_{\perp i}^a + \boxed{qB_{zi}^a \mathbf{v}_{\perp i} \times \hat{\mathbf{z}}} - q \frac{1}{\gamma_b^2} \left. \frac{\partial \phi}{\mathbf{x}_{\perp}} \right|_i$$

Term 1

Term 2

Transform **Terms 1** and **2** in the particle equation of motion:

$$\begin{aligned} \text{Term 1: } \frac{d}{dt} \left(m\gamma_i \frac{d\mathbf{x}_{\perp i}}{dt} \right) &= mv_{zi} \frac{d}{ds} \left(\gamma_i v_{zi} \frac{d\mathbf{x}_{\perp i}}{ds} \right) & \frac{d}{dt} &= v_{zi} \frac{d}{ds} \\ &= m\gamma_i v_{zi}^2 \frac{d^2}{ds^2} \mathbf{x}_{\perp i} + mv_{zi} \left(\frac{d}{ds} \mathbf{x}_{\perp i} \right) \frac{d}{ds} (\gamma_i v_{zi}) \\ & \qquad \qquad \qquad \text{Term 1A} & \qquad \qquad \qquad \text{Term 1B} \end{aligned}$$

Approximate:

$$\text{Term 1A: } m\gamma_i v_{zi}^2 \frac{d^2}{ds^2} \mathbf{x}_{\perp i} \simeq m\gamma_b \beta_b^2 c^2 \frac{d^2}{ds^2} \mathbf{x}_{\perp i} = m\gamma_b \beta_b^2 c^2 \mathbf{x}_{\perp i}''$$

$$\begin{aligned} \text{Term 1B: } mv_{zi} \left(\frac{d}{ds} \mathbf{x}_{\perp i} \right) \frac{d}{ds} (\gamma_i v_{zi}) &\simeq m\beta_b c \left(\frac{d}{ds} \mathbf{x}_{\perp i} \right) \frac{d}{ds} (\gamma_b \beta_b c) \\ &\simeq m\beta_b c^2 (\gamma_b \beta_b)' \mathbf{x}_{\perp i}' \end{aligned}$$

Using the approximations **1A** and **1B** gives for **Term 1**:

$$m \frac{d}{dt} \left(\gamma_i \frac{d\mathbf{x}_{\perp i}}{dt} \right) \simeq m \gamma_b \beta_b^2 c^2 \left[\mathbf{x}_{\perp i}'' + \frac{(\gamma_b \beta_b)'}{(\gamma_b \beta_b)} \mathbf{x}_{\perp i}' \right]$$

Similarly we approximate in **Term 2**:

$$q B_{zi}^a \mathbf{v}_{\perp i} \times \hat{\mathbf{z}} \simeq q B_{zi}^a \beta_b c \mathbf{x}_{\perp i}' \times \hat{\mathbf{z}}$$

Using the simplified expressions for **Terms 1** and **2** obtain the reduced transverse equation of motion:

$$\begin{aligned} \mathbf{x}_{\perp i}'' + \frac{(\gamma_b \beta_b)'}{(\gamma_b \beta_b)} \mathbf{x}_{\perp i}' &= \frac{q}{m \gamma_b \beta_b^2 c^2} \mathbf{E}_{\perp i}^a + \frac{q}{m \gamma_b \beta_b c} \hat{\mathbf{z}} \times \mathbf{B}_{\perp i}^a \\ &+ \frac{q B_{zi}^a}{m \gamma_b \beta_b c} \mathbf{x}_{\perp i}' \times \hat{\mathbf{z}} - \frac{q}{m \gamma_b^3 \beta_b^2 c^2} \left. \frac{\partial \phi}{\partial \mathbf{x}_{\perp}} \right|_i \end{aligned}$$

- ◆ Will be analyzed extensively in lectures that follow in various limits to better understand solution properties

S1G: Summary: Transverse Particle Equations of Motion

$$\mathbf{x}_{\perp}'' + \frac{(\gamma_b \beta_b)'}{(\gamma_b \beta_b)} \mathbf{x}_{\perp}' = \frac{q}{m \gamma_b \beta_b^2 c^2} \mathbf{E}_{\perp}^a + \frac{q}{m \gamma_b \beta_b c} \hat{\mathbf{z}} \times \mathbf{B}_{\perp}^a + \frac{q B_z^a}{m \gamma_b \beta_b c} \mathbf{x}_{\perp}' \times \hat{\mathbf{z}} - \frac{q}{m \gamma_b^3 \beta_b^2 c^2} \frac{\partial}{\partial \mathbf{x}_{\perp}} \phi$$

\mathbf{E}^a = Applied Electric Field

\mathbf{B}^a = Applied Magnetic Field

$$' \equiv \frac{d}{ds}$$

$$\gamma_b \equiv \frac{1}{\sqrt{1 - \beta_b^2}}$$

$$\nabla^2 \phi = \frac{\partial}{\partial \mathbf{x}} \cdot \frac{\partial}{\partial \mathbf{x}} \phi = -\frac{\rho}{\epsilon_0}$$

+ Boundary Conditions on ϕ

Drop particle i subscripts (in most cases) henceforth to simplify notation

Neglects axial energy spread, bending, and electromagnetic radiation

γ - factors different in applied and self-field terms:

In $-\frac{q}{m \gamma_b^3 \beta_b^2 c^2} \frac{\partial}{\partial \mathbf{x}} \phi$, contributions to γ_b^3 :

$\gamma_b \implies$ Kinematics

$\gamma_b^2 \implies$ Self-Magnetic Field Corrections (leading order)

Write out transverse particle equations of motion in explicit component form:

$$\begin{aligned}
 x'' + \frac{(\gamma_b \beta_b)'}{(\gamma_b \beta_b)} x' &= \frac{q}{m \gamma_b \beta_b^2 c^2} E_x^a - \frac{q}{m \gamma_b \beta_b c} B_y^a + \frac{q}{m \gamma_b \beta_b c} B_z^a y' \\
 &\quad - \frac{q}{m \gamma_b^3 \beta_b^2 c^2} \frac{\partial \phi}{\partial x} \\
 y'' + \frac{(\gamma_b \beta_b)'}{(\gamma_b \beta_b)} y' &= \frac{q}{m \gamma_b \beta_b^2 c^2} E_y^a + \frac{q}{m \gamma_b \beta_b c} B_x^a - \frac{q}{m \gamma_b \beta_b c} B_z^a x' \\
 &\quad - \frac{q}{m \gamma_b^3 \beta_b^2 c^2} \frac{\partial \phi}{\partial y}
 \end{aligned}$$

S1H: Preview: Analysis to Come

Much of transverse accelerator physics centers on understanding the evolution of beam particles in 4-dimensional $x-x'$ and $y-y'$ phase space.

Typically, restricted 2-dimensional phase-space projections in $x-x'$ and/or $y-y'$ are analyzed to simplify interpretations:

When forces are linear particles tend to move on ellipses of constant area
- Ellipse may elongate/shrink and rotate as beam evolves in lattice

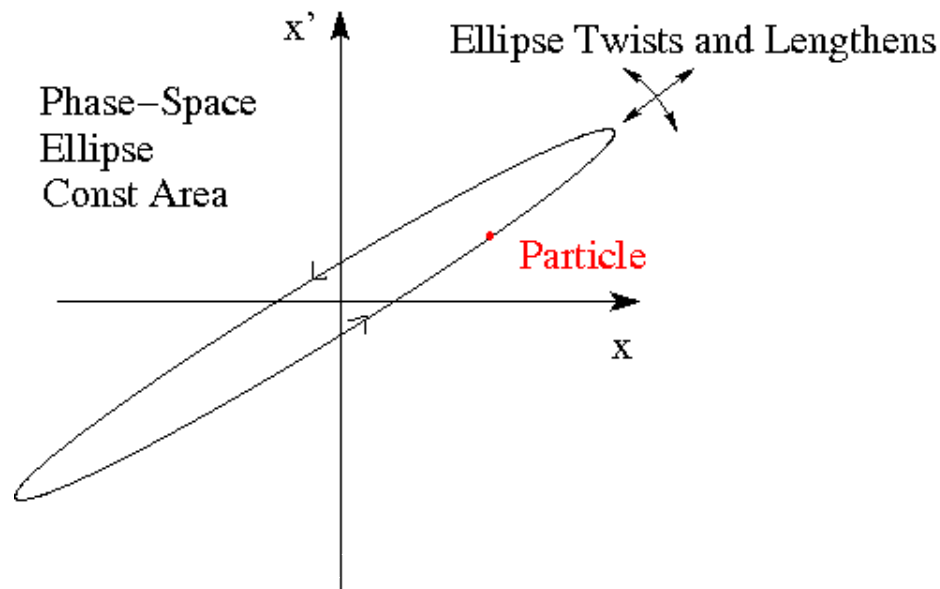

Nonlinear force components distort orbits and cause undesirable effects
- Growth in effective phase-space area reduces focusability

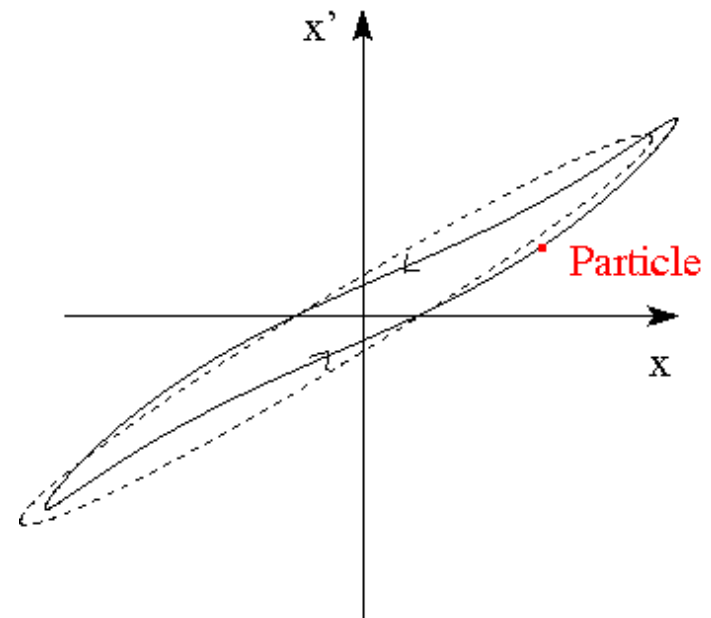

The “effective” phase-space volume of a distribution of beam particles is of fundamental interest

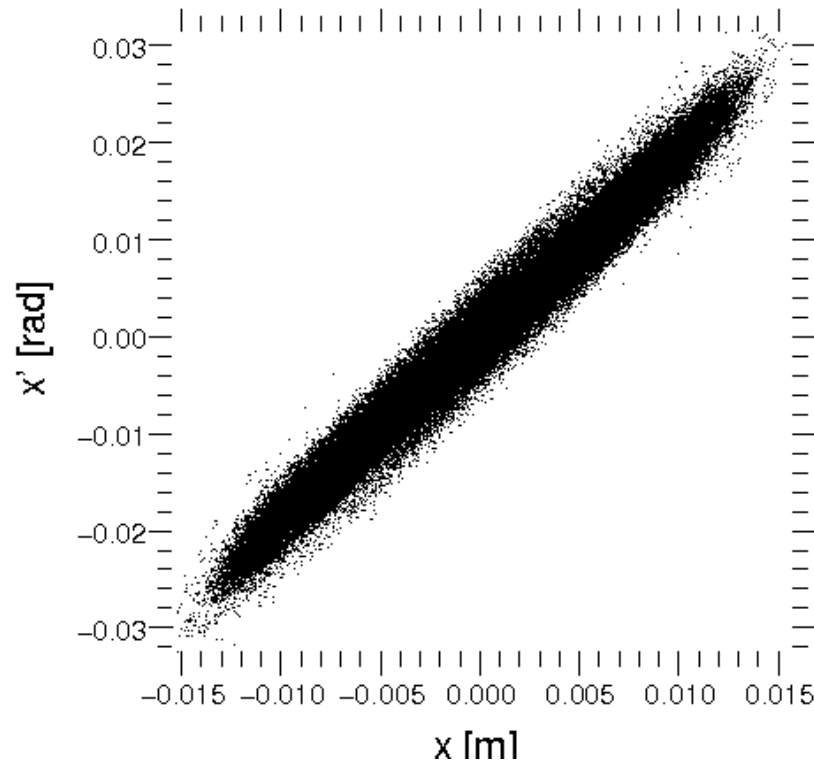

Effective area measure in x - x' phase-space is the x -emittance

Statistical ”Area” $\sim \pi \epsilon_x$

$$\epsilon_x = 4[\langle x^2 \rangle_{\perp} \langle x'^2 \rangle_{\perp} - \langle xx' \rangle_{\perp}^2]^{1/2}$$

We will find in statistical beam descriptions that:

Larger/Smaller beam phase-space areas
(**Larger/Smaller** emittances)



Harder/Easier
to focus beam
on small final spots

Much of advanced accelerator physics centers on preserving beam quality by understanding and controlling **emittance growth** due to **nonlinear forces** arising from both space-charge and the applied focusing. In the remainder of the next few lectures we will review the physics of a single particles moving in linear applied fields with emphasis on transverse effects. Later, we will generalize concepts to include forces from space-charge in this formulation and nonlinear effects from both applied and self-fields.

S1I: Bent Coordinate System and Particle Equations of Motion with Dipole Bends and Axial Momentum Spread

The previous equations of motion can be applied to dipole bends provided the x, y, z coordinate system is fixed. It can prove more convenient to employ coordinates that follow the beam in a bend.

- Orthogonal system employed called Frenet-Serret coordinates

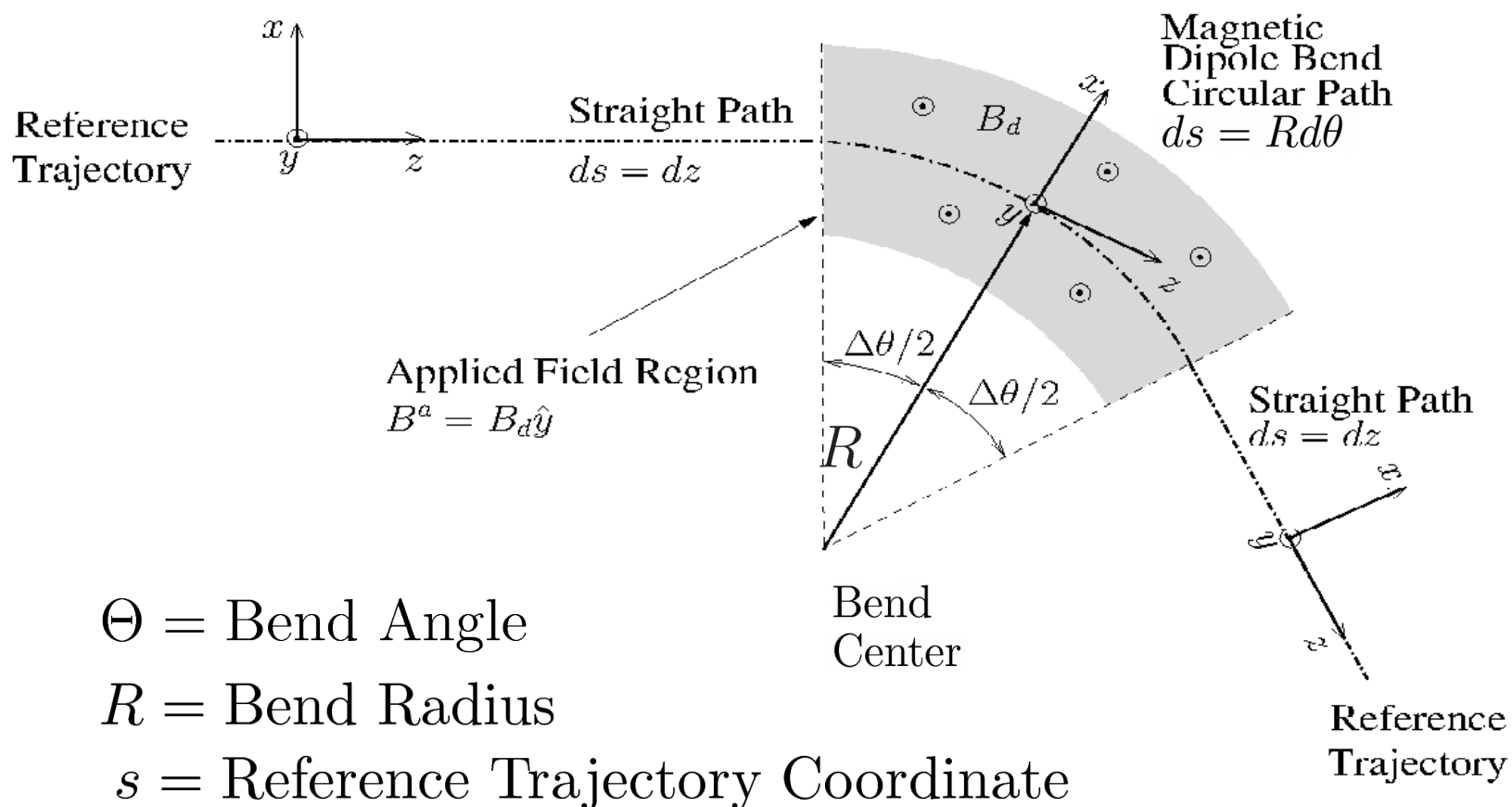

In this perspective, dipoles are adjusted given the design momentum of the reference particle to bend the orbit through a radius R .

- ◆ Bends usually only in one plane (say x)
 - Implemented by a dipole applied field: E_x^a or B_y^a
- ◆ Easy to apply material analogously for y -plane bends, if necessary

Denote:

$$p_0 = m\gamma_b\beta_b c = \text{design momentum}$$

Then a magnetic x -bend through a radius R is specified by:

$$\mathbf{B}^a = B_y^a \hat{\mathbf{y}} = \text{const in bend}$$
$$\frac{1}{R} = \frac{qB_y^a}{p_0}$$

Analogous formula for
Electric Bend will be derived
in problem set

The **particle rigidity** is defined as ($[B\rho]$ read as one symbol called “B-Rho”):

$$[B\rho] \equiv \frac{p_0}{q} = \frac{m\gamma_b\beta_b c}{q}$$

is often applied to express the bend result as:

$$\frac{1}{R} = \frac{B_y^a}{[B\rho]}$$

Comments on bends:

- ◆ R can be **positive** or **negative** depending on sign of $B_y^a / [B\rho]$
- ◆ For **straight** sections, $R \rightarrow \infty$ (or equivalently, $B_y^a = 0$)
- ◆ Lattices often made from discrete element dipoles and straight sections with separated function optics
 - Bends can provide “edge focusing”
 - Sometimes elements for bending/focusing are combined
- ◆ For a ring, dipoles strengths are tuned with particle rigidity/momentum so the reference orbit makes a closed path lap through the circular machine
 - Dipoles adjusted as particles gain energy to maintain closed path
 - In a Synchrotron dipoles and focusing elements are adjusted together to maintain focusing and bending properties as the particles gain energy. This is the origin of the name “Synchrotron.”
- ◆ Total bending strength of a ring in Tesla-meters limits the ultimately achievable particle energy/momentum in the ring

For a magnetic field over a path length S , the beam will be bent through an angle:

$$\Theta = \frac{S}{R} = \frac{SB_y^a}{[B\rho]}$$

To make a ring, the bends must deflect the beam through a total angle of 2π :

- ◆ Neglect any energy gain changing the rigidity over one lap

$$2\pi = \sum_{i, \text{Dipoles}} \Theta_i = \sum_i \frac{S_i}{R_i} = \sum_i \frac{S_i B_{y,i}^a}{[B\rho]}$$

For a symmetric ring, N dipoles are all the same, giving for the bend field:

- ◆ Typically choose parameters for dipole field as high as technology allows for a compact ring

$$B_y^a = 2\pi \frac{[B\rho]}{NS}$$

For a symmetric ring of total circumference C with straight sections of length L between the bends:

- ◆ Features of straight sections typically dictated by needs of focusing, acceleration, and dispersion control

$$C = NS + NL$$

Example: Typical separated function lattice in a Synchrotron

Focus Elements in Red

Bending Elements in Green

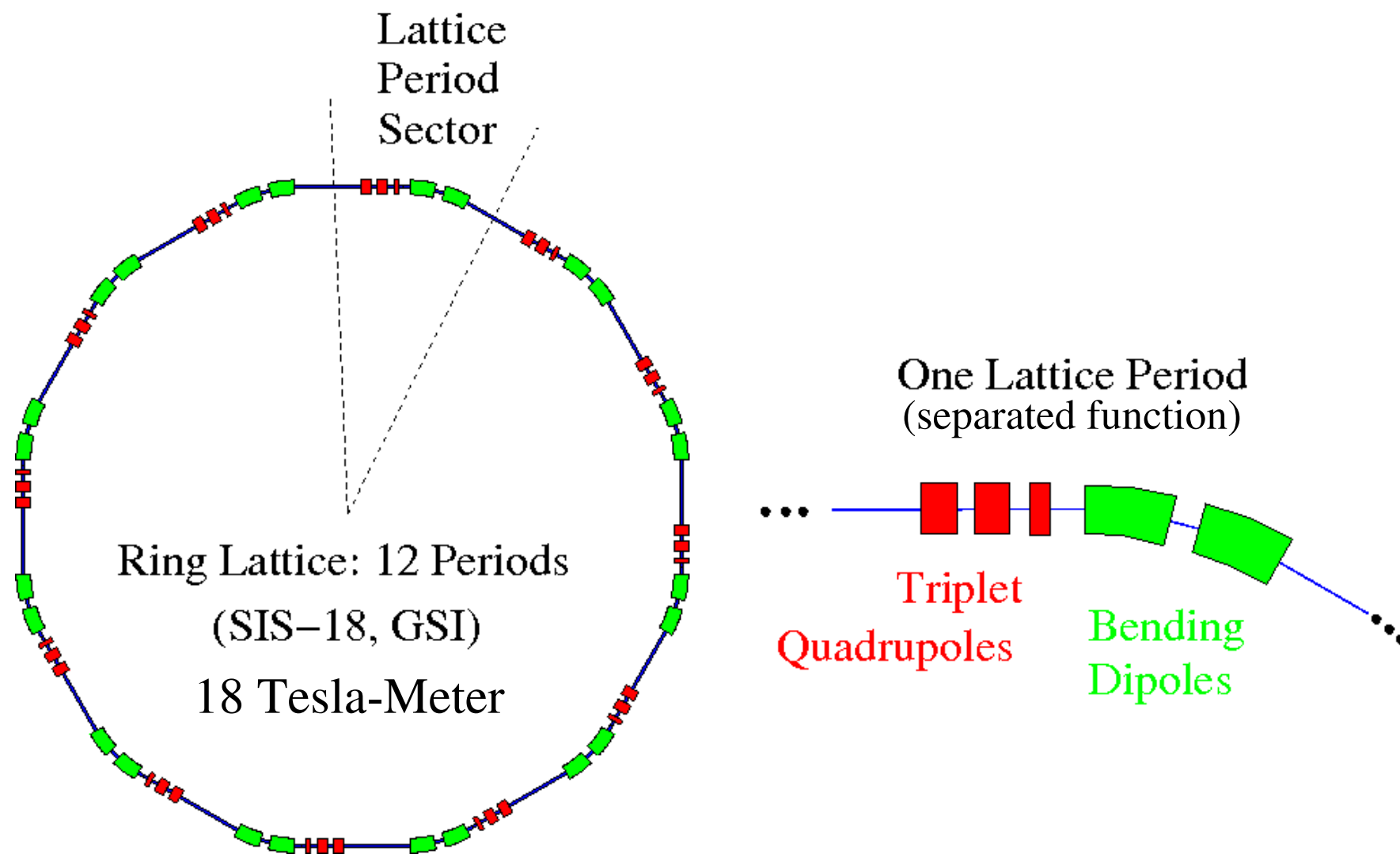

For “off-momentum” errors:

$$p_s = p_0 + \delta p$$

$$p_0 = m\gamma_b\beta_b c = \text{design momentum}$$

$$\delta p = \text{off- momentum}$$

This will modify the particle equations of motion, particularly in cases where there are bends since particles with different momenta will be bent at different radii

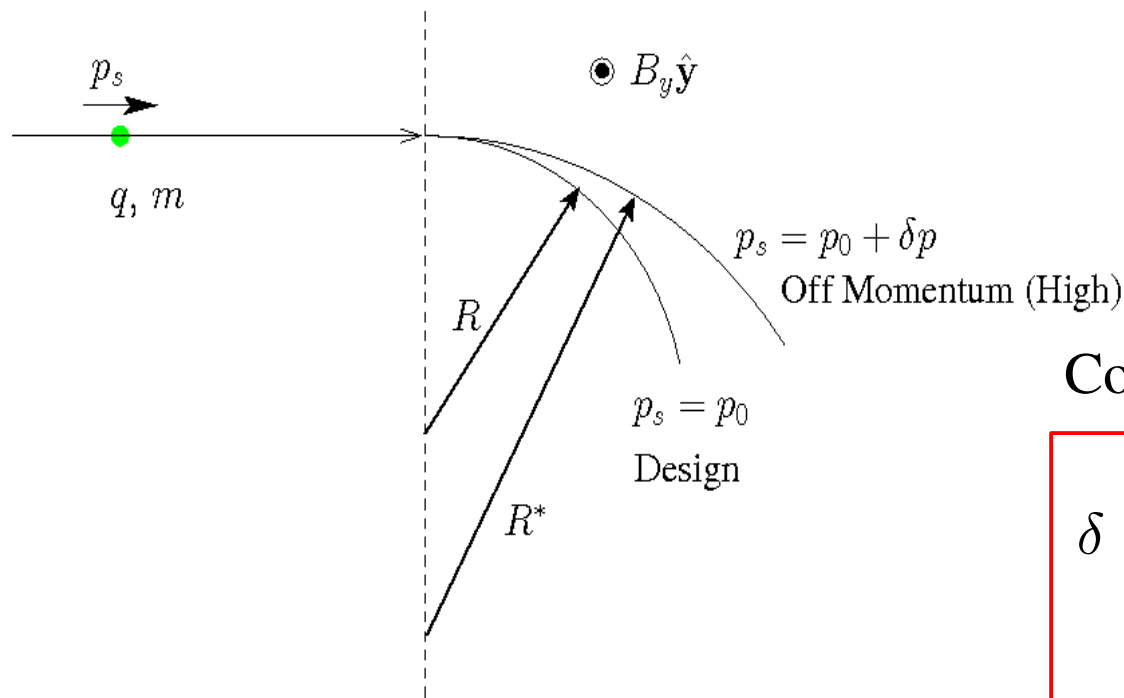

Common notation:

$$\delta \equiv \frac{\delta p}{p_0} = \text{Fractional}$$

Momentum Error

- ◆ Not usual to have acceleration in bends
 - Dipole bends and quadrupole focusing are sometimes combined

Derivatives in accelerator Frenet-Serret Coordinates

Summarize results only needed to transform the Maxwell equations, write field derivatives, etc.

- ◆ Reference: Chao and Tigner, *Handbook of Accelerator Physics and Engineering*

$$\Psi(x, y, s) \quad = \text{Scalar}$$

$$\mathbf{V}(x, y, s) = V_x(x, y, s)\hat{\mathbf{x}} + V_y(x, y, s)\hat{\mathbf{y}} + V_s(x, y, s)\hat{\mathbf{s}} \quad = \text{Vector}$$

Vector Dot and Cross-Products: ($\mathbf{V}_1, \mathbf{V}_2$ Two Vectors)

$$\mathbf{V}_1 \cdot \mathbf{V}_2 = V_{1x}V_{2x} + V_{1y}V_{2y} + V_{1s}V_{2s}$$

$$\begin{aligned} \mathbf{V}_1 \times \mathbf{V}_2 &= \begin{vmatrix} \hat{\mathbf{x}} & \hat{\mathbf{y}} & \hat{\mathbf{s}} \\ V_{1x} & V_{1y} & V_{1s} \\ V_{2x} & V_{2y} & V_{2s} \end{vmatrix} \\ &= (V_{1x}V_{2s} - V_{1s}V_{2x})\hat{\mathbf{x}} + (V_{1s}V_{2x} - V_{1x}V_{2s})\hat{\mathbf{y}} + (V_{1x}V_{2y} - V_{1y}V_{2x})\hat{\mathbf{s}} \end{aligned}$$

Elements:

$$d^2x_{\perp} = dx dy$$

$$d^3x_{\perp} = \left(1 + \frac{x}{R}\right) dx dy ds$$

$$d\vec{\ell} = \hat{\mathbf{x}}dx + \hat{\mathbf{y}}dy + \hat{\mathbf{s}} \left(1 + \frac{x}{R}\right) ds$$

Gradient:

$$\nabla \Psi = \hat{\mathbf{x}} \frac{\partial \Psi}{\partial x} + \hat{\mathbf{y}} \frac{\partial \Psi'}{\partial y} + \hat{\mathbf{s}} \frac{1}{1 + x/R} \frac{\partial \Psi}{\partial s}$$

Divergence:

$$\nabla \cdot \mathbf{V} = \frac{1}{1 + x/R} \frac{\partial}{\partial x} [(1 + x/R)V_x] + \frac{\partial V_y}{\partial y} + \frac{1}{1 + x/R} \frac{\partial V_s}{\partial s}$$

Curl:

$$\begin{aligned} \nabla \times \mathbf{V} = & \hat{\mathbf{x}} \left(\frac{\partial V_s}{\partial y} - \frac{1}{1 + x/R} \frac{\partial V_y}{\partial s} \right) + \hat{\mathbf{y}} \frac{1}{1 + x/R} \left(\frac{\partial V_x}{\partial s} - \frac{\partial}{\partial x} [(1 + x/R)V_s] \right) \\ & + \hat{\mathbf{s}}(1 + x/R) \left(\frac{\partial V_y}{\partial x} - \frac{\partial V_x}{\partial y} \right) \end{aligned}$$

Laplacian:

$$\nabla^2 \Psi = \frac{1}{1 + x/R} \frac{\partial}{\partial x} \left[\left(1 + \frac{x}{R}\right) \frac{\partial \Psi}{\partial x} \right] + \frac{\partial^2 \Psi}{\partial y^2} + \frac{1}{1 + x/R} \frac{\partial}{\partial s} \left[\frac{1}{1 + x/R} \frac{\partial \Psi}{\partial s} \right]$$

Transverse particle equations of motion including bends and “off-momentum” effects

- ◆ See texts such as Edwards and Syphers for guidance on derivation steps
- ◆ Full derivation is beyond needs/scope of this class

$$x'' + \frac{(\gamma_b \beta_b)'}{(\gamma_b \beta_b)} x' + \left[\frac{1}{R^2(s)} \frac{1 - \delta}{1 + \delta} \right] x = \frac{\delta}{1 + \delta} \frac{1}{R(s)} + \frac{q}{m \gamma_b \beta_b^2 c^2} \frac{E_x^a}{(1 + \delta)^2}$$

$$- \frac{q}{m \gamma_b \beta_b c} \frac{B_y^a}{1 + \delta} + \frac{q}{m \gamma_b \beta_b c} \frac{B_s^a}{1 + \delta} y' - \frac{q}{m \gamma_b^3 \beta_b^2 c^2} \frac{1}{1 + \delta} \frac{\partial \phi}{\partial x}$$

$$y'' + \frac{(\gamma_b \beta_b)'}{(\gamma_b \beta_b)} y' = \frac{q}{m \gamma_b \beta_b^2 c^2} \frac{E_y^a}{(1 + \delta)^2} + \frac{q}{m \gamma_b \beta_b c} \frac{B_x^a}{1 + \delta}$$

$$- \frac{q}{m \gamma_b \beta_b c} \frac{B_s^a}{1 + \delta} x' - \frac{q}{m \gamma_b^3 \beta_b^2 c^2} \frac{1}{1 + \delta} \frac{\partial \phi}{\partial y}$$

$$p_0 = m \gamma_b \beta_b c = \text{Design Momentum}$$

$$\delta \equiv \frac{\delta p}{p_0} = \text{Fractional Momentum Error}$$

$$\frac{1}{R(s)} = \frac{B_y^a(s)|_{\text{Dipole}}}{[B\rho]} \quad [B\rho] = \frac{p_0}{q}$$

Comments:

- ◆ Design bends only in x and B_y^a , E_x^a contain no dipole terms (design orbit)
 - Dipole components set via the design bend radius $R(s)$
- ◆ Equations contain only low-order terms in momentum spread δ

Comments continued:

- ◆ Equations are often applied linearized in δ
- ◆ Achromatic focusing lattices are often designed using equations with momentum spread to obtain focal points independent of δ to some order
 x and y equations differ significantly due to bends modifying the x -equation when $R(s)$ is finite
- ◆ It will be shown in the problems that for electric bends:

$$\frac{1}{R(s)} = \frac{E_x^a(s)}{\beta_b c [B\rho]}$$

- ◆ Applied fields for focusing: \mathbf{E}_\perp^a , \mathbf{B}_\perp^a , B_s^a
must be expressed in the bent x, y, s system of the reference orbit
 - Includes error fields in dipoles
- ◆ Self fields may also need to be solved taking into account bend terms
 - Often can be neglected in Poisson's Equation

$$\left\{ \frac{1}{1 + x/R} \frac{\partial}{\partial x} \left[\left(1 + \frac{x}{R}\right) \frac{\partial}{\partial x} \right] + \frac{\partial^2}{\partial y^2} + \frac{1}{1 + x/R} \frac{\partial}{\partial s} \left[\frac{1}{1 + x/R} \frac{\partial}{\partial s} \right] \right\} \phi = -\frac{\rho}{\epsilon_0}$$

if $R \rightarrow \infty$

reduces to familiar:
$$\left\{ \frac{\partial^2}{\partial x^2} + \frac{\partial^2}{\partial y^2} + \frac{\partial^2}{\partial s^2} \right\} \phi = -\frac{\rho}{\epsilon_0}$$

Appendix A: Gamma and Beta Factor Conversions

It is frequently the case that functions of the relativistic gamma and beta factors are converted to superficially different appearing forms when analyzing transverse particle dynamics in order to more cleanly express results. Here we summarize useful formulas in that come up when comparing various forms of equations.

Derivatives are taken wrt the axial coordinate s but also apply wrt time t

Results summarized here can be immediately applied in the paraxial approximation by taking:

$$v = |\mathbf{v}| \simeq v_b = \beta_b c \quad \Longrightarrow \quad \begin{aligned} \beta &\simeq \beta_b \\ \gamma &\simeq \gamma_b \end{aligned}$$

Assume that the beam is forward going with $\beta \geq 0$:

$$\begin{aligned} \gamma &\equiv \frac{1}{\sqrt{1 - \beta^2}} & \beta &= \frac{1}{\gamma} \sqrt{\gamma^2 - 1} \\ \gamma^2 &= \frac{1}{1 - \beta^2} & \beta^2 &= 1 - 1/\gamma^2 \end{aligned}$$

A commonly occurring acceleration factor can be expressed in several ways:

- ◆ Depending on choice used, equations can look quite different!

$$\frac{(\gamma\beta)'}{(\gamma\beta)} = \frac{\gamma'}{\gamma} + \frac{\beta'}{\beta} = \frac{\gamma'}{\gamma\beta^2}$$

Axial derivative factors can be converted using:

$$\gamma' = \frac{\beta\beta'}{(1 - \beta^2)^{3/2}} \qquad \beta' = \frac{\gamma'}{\gamma^2 \sqrt{\gamma^2 - 1}}$$

Energy factors:

$$\mathcal{E}_{\text{tot}} = \gamma mc^2 = \mathcal{E} + mc^2$$

$$\gamma\beta = \sqrt{\left(\frac{\mathcal{E}}{mc^2}\right)^2 + 2\left(\frac{\mathcal{E}}{mc^2}\right)}$$

Rigidity:

$$[B\rho] = \frac{p}{q} = \frac{\gamma mv}{q} = \frac{mc}{q} \gamma\beta = \frac{mc}{q} \sqrt{\left(\frac{\mathcal{E}}{mc^2}\right)^2 + 2\left(\frac{\mathcal{E}}{mc^2}\right)}$$

Appendix B: Magnetic Self-Fields

The full Maxwell equations for the beam self fields

$$\mathbf{E}^s, \quad \mathbf{B}^s$$

with electromagnetic effects neglected can be written as

- ◆ Good approx typically for slowly varying ions in weak fields

$$\nabla \cdot \mathbf{E}^s = \frac{\rho}{\epsilon_0} \qquad \nabla \times \mathbf{B}^s = \mu_0 \mathbf{J} + \frac{1}{c^2} \frac{\partial}{\partial t} \mathbf{E}^s$$

$$\nabla \times \mathbf{E}^s = - \frac{\partial}{\partial t} \mathbf{B}^s \qquad \nabla \cdot \mathbf{B}^s = 0$$

+ Boundary Conditions on \mathbf{E}^s and \mathbf{B}^s
from material structures, etc.

$$\rho = qn(\mathbf{x}, t)$$

$$\mathbf{J} = qn(\mathbf{x}, t)\mathbf{V}(\mathbf{x}, t)$$

$n(\mathbf{x}, t)$ = Number Density

$\mathbf{V}(\mathbf{x}, t)$ = "Fluid" Flow Velocity

- ◆ Beam terms from charged particles making up the beam

- ◆ Calc from continuum approx distribution

Electrostatic Approx:

$$\begin{aligned}\nabla \cdot \mathbf{E}^s &= \frac{qn}{\epsilon_0} \\ \nabla \times \mathbf{E}^s &= 0\end{aligned}$$

$$\mathbf{E}^s = -\nabla\phi$$

ϕ = Electrostatic

Scalar Potential

$$\begin{aligned}\Rightarrow \nabla \times \mathbf{E}^s &= -\nabla \times \nabla\phi = 0 \\ &\text{Continuity of mixed} \\ &\text{partial derivatives}\end{aligned}$$

$$\Rightarrow \nabla \cdot \mathbf{E}^s = -\nabla \cdot \nabla\phi = \frac{qn}{\epsilon_0}$$

$$\begin{aligned}\nabla^2\phi &= -\frac{qn}{\epsilon_0} \\ &+ \text{Boundary Conditions on } \phi\end{aligned}$$

Magnetostatic Approx:

$$\begin{aligned}\nabla \times \mathbf{B}^s &= \mu_0\mathbf{J} \\ \nabla \cdot \mathbf{B}^s &= 0\end{aligned}$$

$$\mathbf{B}^s = \nabla \times \mathbf{A}$$

\mathbf{A} = Magnetostatic

Vector Potential

$$\Rightarrow \nabla \cdot \mathbf{B}^s = \nabla \cdot (\nabla \times \mathbf{A}) = 0$$

Continuity of mixed
partial derivatives

$$\Rightarrow \nabla \times \mathbf{B}^s = \nabla \times (\nabla \times \mathbf{A}) = \mu_0\mathbf{J}$$

Continue next slide

Magnetostatic Approx Continued:

$$\nabla \times \mathbf{B}^s = \nabla \times (\nabla \times \mathbf{A}) = \mu_0 \mathbf{J}$$

$$\nabla(\nabla \cdot \mathbf{A}) - \nabla^2 \mathbf{A} = \mu_0 \mathbf{J}$$

Still free to take (gauge choice):

$$\nabla \cdot \mathbf{A} = 0 \quad \text{Coulomb Gauge}$$

Can always meet this choice:

$$\mathbf{A} \rightarrow \mathbf{A} + \nabla \xi \quad \xi = \text{Some Function}$$

$$\implies \mathbf{B}^s = \nabla \times \mathbf{A} \rightarrow \nabla \times \mathbf{A} + \nabla \times \nabla \xi = \nabla \times \mathbf{A}$$

$$\implies \nabla \cdot \mathbf{A} \rightarrow \nabla \cdot \mathbf{A} + \nabla^2 \xi$$

0 Cont mixed partial derivatives

Can always choose ξ such that $\nabla \cdot \mathbf{A} = 0$ to satisfy the Coulomb gauge:

$$\nabla^2 \mathbf{A} = -\mu_0 \mathbf{J} = -\mu_0 qn \mathbf{V}$$

+ Boundary Conditions on \mathbf{A}

- ◆ Essentially one Poisson form eqn for each field x,y,z comp
- ◆ Boundary conditions diff than ϕ

But can approximate this further for “typical” paraxial beams

$$\nabla^2 \mathbf{A} = -\mu_0 \mathbf{J} = -\mu_0 q n \mathbf{V}$$

Expect for a beam with primarily forward (paraxial) directed motion:

$$V_z = \beta_b c \quad V_{x,y} \sim R' \beta_b c \quad R' = \text{Beam Envelope Angle} \\ (\text{Typically } 10\text{s mrad Magnitude})$$

$$\implies |A_{x,y}| \ll |A_z|$$

Giving:

$$\nabla^2 A_z = -\mu_0 q \beta_b c n \quad n = -\frac{\epsilon_0}{q} \nabla^2 \phi \quad \text{Free to use from electrostatic part}$$

$$\nabla^2 A_z = (\mu_0 \epsilon_0) c \beta_b \nabla^2 \phi \quad \mu_0 \epsilon_0 = \frac{1}{c^2} \quad \text{From unit definition}$$

$$\nabla^2 A_z = \frac{\beta_b}{c} \nabla^2 \phi$$

$$\implies A_z = \frac{\beta_b}{c} \phi$$

- Allows simply taking into account low-order self-magnetic field effects
 - Care must be taken if magnetic materials are present close to beam

Further insight can be obtained on the nature of the approximations in the reduced form of the self-magnetic field correction by examining Lorentz Transformation properties of the potentials.

From EM theory, the potentials ϕ , $c\mathbf{A}$ form a relativistic 4-vector that transforms as a Lorentz vector for covariance:

$$A_\mu = (\phi, c\mathbf{A})$$

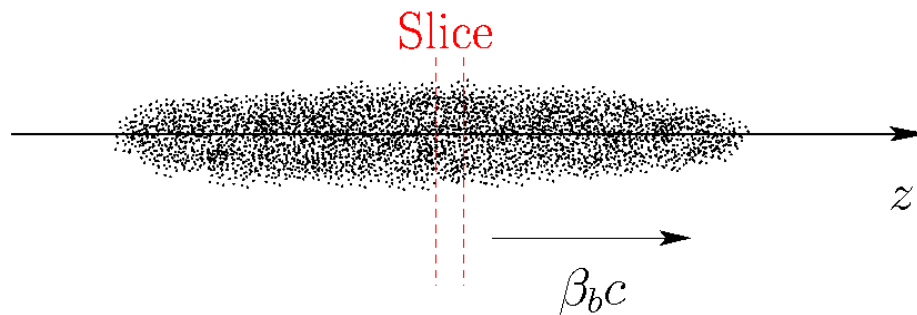

In the rest frame (*) of the beam, assume that the flows are small enough where the potentials are purely electrostatic with:

$$A_\mu^* = (\phi^*, \mathbf{0}) \quad \nabla^2 \phi^* = -\frac{qn^*}{\epsilon_0}$$

Review: Under Lorentz transform, the 4-vector components of $A_\mu = (\phi, c\mathbf{A})$ transform as the familiar 4-vector $x_\mu = (ct, \mathbf{x})$

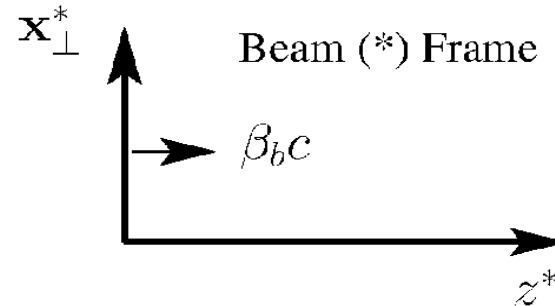
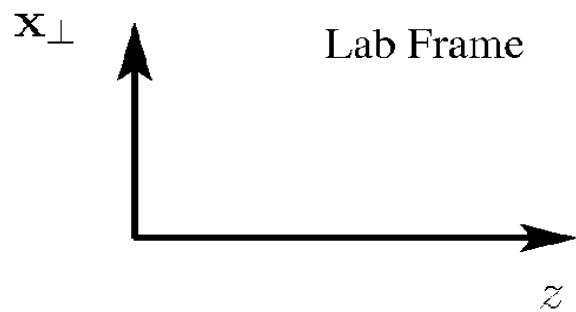

Transform

$$ct^* = \gamma_b(ct - \beta_b z)$$

$$z^* = \gamma_b(z - \beta_b ct)$$

$$\mathbf{x}^* = \mathbf{x}_\perp$$

Inverse Transform

$$ct = \gamma_b(ct^* + \beta_b z^*)$$

$$z = \gamma_b(z^* + \beta_b ct^*)$$

$$\mathbf{x} = \mathbf{x}_\perp^*$$

This gives for the 4-potential $A_\mu = (\phi, c\mathbf{A})$:

$$\phi = \gamma_b(\phi^* + \beta_b cA_z^*) = \gamma_b\phi^*$$

$$cA_z = \gamma_b(cA_z^* + \beta_b\phi^*) = \beta_b(\gamma_b\phi^*) = \beta_b\phi$$

$$\implies A_z = \frac{\beta_b}{c}\phi$$

- Shows result is consistent with pure electrostatic in beam (*) frame

S2: Transverse Particle Equations of Motion in Linear Applied Focusing Channels

S2A: Introduction

Write out transverse particle equations of motion in explicit component form:

$$\begin{aligned}x'' + \frac{(\gamma_b \beta_b)'}{(\gamma_b \beta_b)} x' &= \frac{q}{m \gamma_b \beta_b^2 c^2} E_x^a - \frac{q}{m \gamma_b \beta_b c} B_y^a + \frac{q}{m \gamma_b \beta_b c} B_z^a y' \\ &\quad - \frac{q}{m \gamma_b^3 \beta_b^2 c^2} \frac{\partial \phi}{\partial x} \\ y'' + \frac{(\gamma_b \beta_b)'}{(\gamma_b \beta_b)} y' &= \frac{q}{m \gamma_b \beta_b^2 c^2} E_y^a + \frac{q}{m \gamma_b \beta_b c} B_x^a - \frac{q}{m \gamma_b \beta_b c} B_z^a x' \\ &\quad - \frac{q}{m \gamma_b^3 \beta_b^2 c^2} \frac{\partial \phi}{\partial y}\end{aligned}$$

Equations previously derived under assumptions:

- ◆ No bends (fixed x-y-z coordinate system with no local bends)
- ◆ Paraxial equations ($x'^2, y'^2 \ll 1$)
- ◆ No dispersive effects (β_b same all particles), acceleration allowed ($\beta_b \neq \text{const}$)
- ◆ Electrostatic and leading-order (in β_b) self-magnetic interactions

The applied focusing fields

$$\text{Electric: } E_x^a, E_y^a$$

$$\text{Magnetic: } B_x^a, B_y^a, B_z^a$$

must be specified as a function of s and the transverse particle coordinates x and y to complete the description

- ◆ Consistent change in axial velocity ($\beta_b c$) due to E_z^a must be evaluated
 - Typically due to RF cavities and/or induction cells
- ◆ Restrict analysis to fields from applied focusing structures

Intense beam accelerators and transport lattices are designed to optimize *linear* applied focusing forces with terms:

$$\text{Electric: } E_x^a \simeq (\text{function of } s) \times (x \text{ or } y)$$

$$E_y^a \simeq (\text{function of } s) \times (x \text{ or } y)$$

$$\text{Magnetic: } B_x^a \simeq (\text{function of } s) \times (x \text{ or } y)$$

$$B_y^a \simeq (\text{function of } s) \times (x \text{ or } y)$$

$$B_z^a \simeq (\text{function of } s)$$

Common situations that realize these linear applied focusing forms will be overviewed:

Continuous Focusing (see: [S2B](#))

Quadrupole Focusing

- Electric (see: [S2C](#))

- Magnetic (see: [S2D](#))

Solenoidal Focusing (see: [S2E](#))

Other situations that will not be covered (typically more nonlinear optics):

Einzel Lens

Plasma Lens

Wire guiding

Why design around linear applied fields ?

- ◆ Linear oscillators have well understood physics allowing formalism to be developed that can guide design
- ◆ Linear fields are “lower order” so it should be possible for a given source amplitude to generate field terms with greater strength than for “higher order” nonlinear fields

S2B: Continuous Focusing

Assume constant electric field applied focusing force:

$$\mathbf{B}^a = 0$$

$$\mathbf{E}_\perp^a = E_x^a \hat{\mathbf{x}} + E_y^a \hat{\mathbf{y}} = -\frac{m\gamma_b\beta_b^2 c^2 k_{\beta 0}^2}{q} \mathbf{x}_\perp \quad k_{\beta 0}^2 \equiv \text{const} > 0$$
$$[k_{\beta 0}] = \frac{\text{rad}}{\text{m}}$$

Continuous focusing equations of motion:

Insert field components into linear applied field equations and collect terms

$$\mathbf{x}_\perp'' + \frac{(\gamma_b\beta_b)'}{(\gamma_b\beta_b)} \mathbf{x}_\perp' + k_{\beta 0}^2 \mathbf{x}_\perp = -\frac{q}{m\gamma_b^3\beta_b^2 c^2} \frac{\partial\phi}{\partial\mathbf{x}_\perp}$$

$$x'' + \frac{(\gamma_b\beta_b)'}{(\gamma_b\beta_b)} x' + k_{\beta 0}^2 x = -\frac{q}{m\gamma_b^3\beta_b^2 c^2} \frac{\partial\phi}{\partial x}$$

$$y'' + \frac{(\gamma_b\beta_b)'}{(\gamma_b\beta_b)} y' + k_{\beta 0}^2 y = -\frac{q}{m\gamma_b^3\beta_b^2 c^2} \frac{\partial\phi}{\partial y}$$

Equivalent
Component
Form

Even this simple model can become complicated

- ◆ **Space charge:** ϕ must be calculated consistent with beam evolution
- ◆ **Acceleration:** acts to damp orbits (see: **S10**)

Simple model in limit of no acceleration ($\gamma_b\beta_b \simeq \text{const}$) and negligible space-charge ($\phi \simeq \text{const}$):

$$\mathbf{x}_{\perp}'' + k_{\beta 0}^2 \mathbf{x}_{\perp} = 0 \implies \text{orbits simple harmonic oscillators}$$

General solution is elementary:

$$\mathbf{x}_{\perp} = \mathbf{x}_{\perp}(s_i) \cos[k_{\beta 0}(s - s_i)] + [\mathbf{x}'_{\perp}(s_i)/k_{\beta 0}] \sin[k_{\beta 0}(s - s_i)]$$

$$\mathbf{x}'_{\perp} = -k_{\beta 0} \mathbf{x}_{\perp}(s_i) \sin[k_{\beta 0}(s - s_i)] + \mathbf{x}'_{\perp}(s_i) \cos[k_{\beta 0}(s - s_i)]$$

$$\mathbf{x}_{\perp}(s_i) = \text{Initial coordinate}$$

$$\mathbf{x}'_{\perp}(s_i) = \text{Initial angle}$$

In terms of a transfer map in the x-plane (y-plane analogous):

$$\begin{bmatrix} x \\ x' \end{bmatrix}_s = \mathbf{M}_x(s|s_i) \cdot \begin{bmatrix} x \\ x' \end{bmatrix}_{s_i}$$

$$\mathbf{M}_x(s|s_i) = \begin{bmatrix} \cos[k_{\beta 0}(s - s_i)] & \frac{1}{k_{\beta 0}} \sin[k_{\beta 0}(s - s_i)] \\ -k_{\beta 0} \sin[k_{\beta 0}(s - s_i)] & \cos[k_{\beta 0}(s - s_i)] \end{bmatrix}$$

/// Example: Particle Orbits in Continuous Focusing

Particle phase-space in x - x' with only applied field

$$k_{\beta 0} = 2\pi \text{ rad/m} \quad x(0) = 1 \text{ mm} \quad y(0) = 0$$

$$\phi \simeq 0 \quad \gamma_b \beta_b = \text{const} \quad x'(0) = 0 \quad y'(0) = 0$$

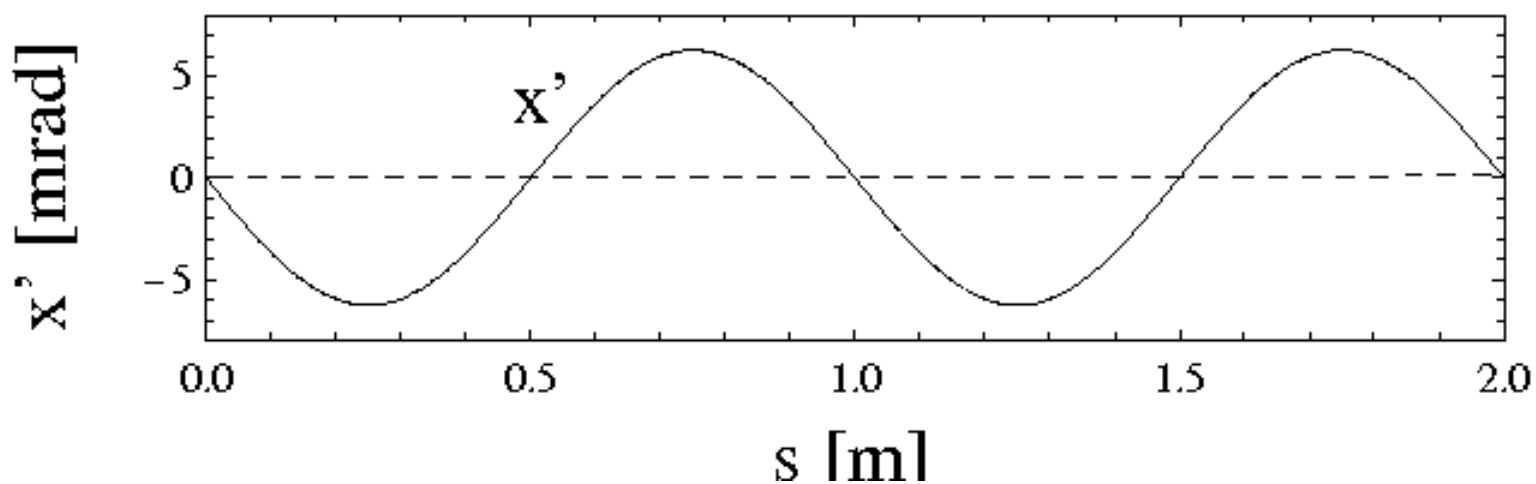
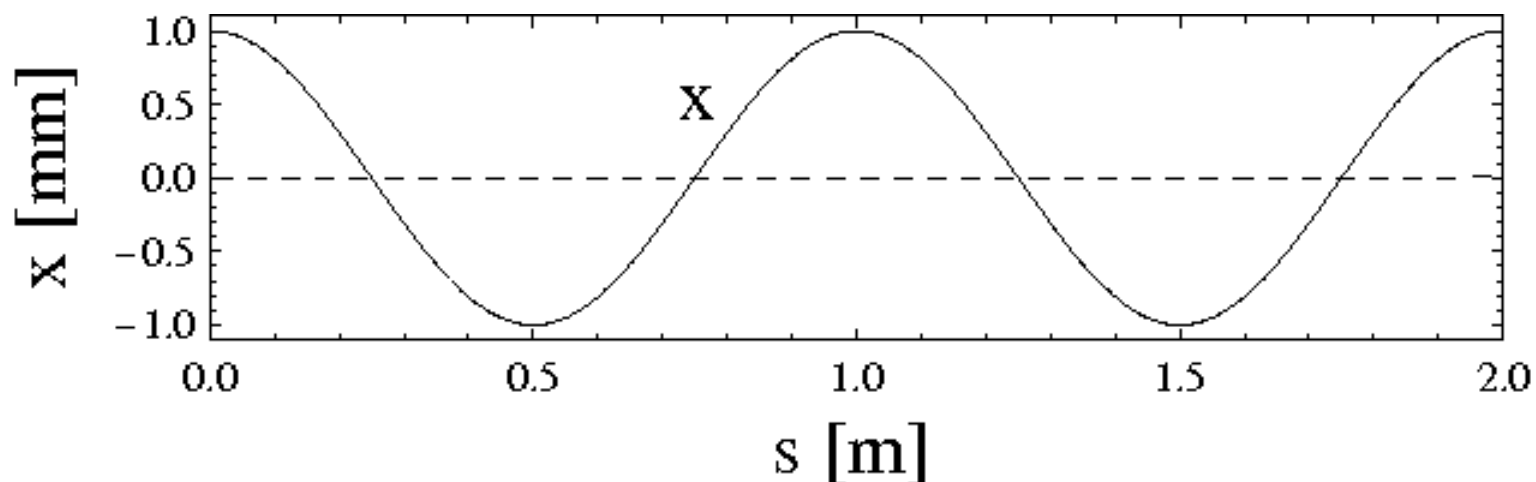

///

Problem with continuous focusing model:

The continuous focusing model is realized by a stationary ($m \rightarrow \infty$) partially neutralizing uniform background of charges filling the beam pipe. To see this apply Maxwell's equations to the applied field to calculate an applied charge density:

$$\rho^a = \epsilon_0 \frac{\partial}{\partial \mathbf{x}} \cdot \mathbf{E}^a = -\frac{2m\epsilon_0\gamma_b\beta_b^2 c^2 k_{\beta 0}^2}{q} = \text{const}$$

- ◆ Unphysical model, but commonly employed since it represents the average action of more physical focusing fields in a simpler to analyze model
 - Demonstrate later in simple examples and problems given
- ◆ Continuous focusing can provide reasonably good estimates for more realistic periodic focusing models if $k_{\beta 0}^2$ is appropriately identified in terms of “equivalent” parameters *and* the periodic system is stable.
 - See lectures that follow and homework problems for examples

In more realistic models, one requires that *quasi-static* focusing fields in the machine aperture satisfy the **vacuum Maxwell equations**

$$\begin{array}{ll} \nabla \cdot \mathbf{E}^a = 0 & \nabla \cdot \mathbf{B}^a = 0 \\ \nabla \times \mathbf{E}^a = 0 & \nabla \times \mathbf{B}^a = 0 \end{array}$$

- ◆ Require in the region of the beam
- ◆ Applied field sources outside of the beam region

The vacuum Maxwell equations constrain the 3D form of applied fields resulting from spatially localized lenses. The following cases are commonly exploited to optimize **linear** focusing strength in physically realizable systems while keeping the model relatively simple:

- 1) **Alternating Gradient Quadrupoles** with transverse orientation
 - Electric Quadrupoles (see: **S2C**)
 - Magnetic Quadrupoles (see: **S2D**)
- 2) **Solenoidal Magnetic Fields** with longitudinal orientation (see: **S2E**)
- 3) **Einzel Lenses**

S2C: Alternating Gradient Quadrupole Focusing

Electric Quadrupoles

In the axial center of a long **electric quadrupole**, model the fields as 2D transverse

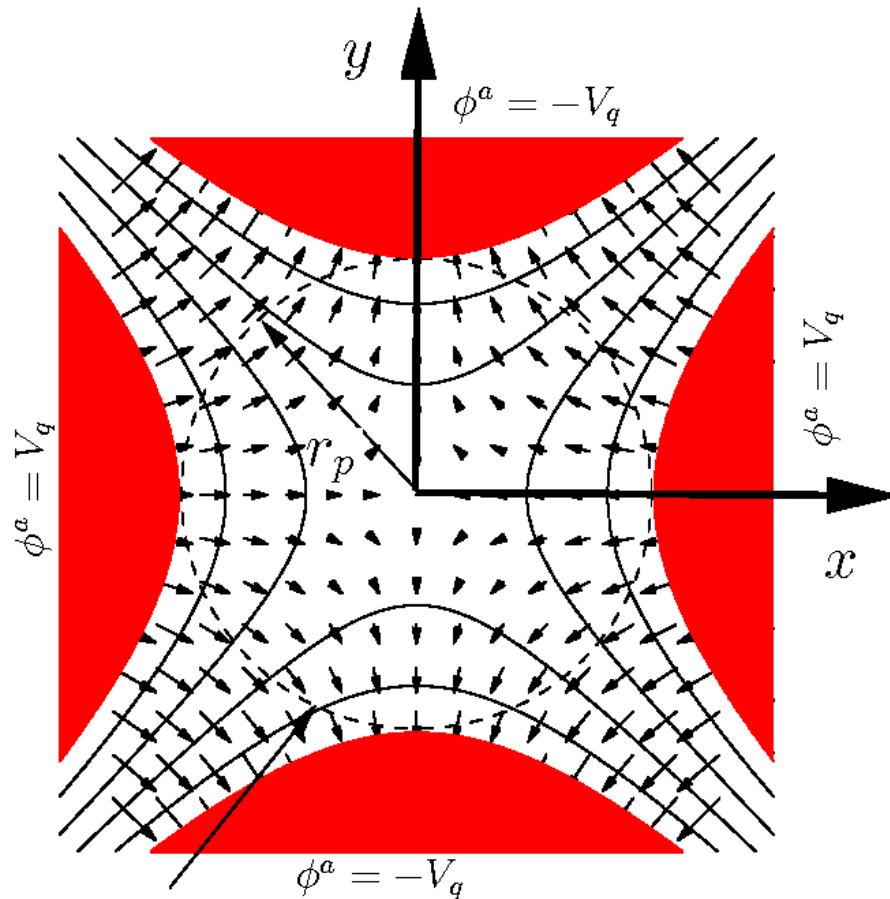

Electrodes Outside of Circle $r = r_p$
 Electrodes: $x^2 - y^2 = \mp r_p^2$

- ◆ Electrodes hyperbolic
- ◆ Structure infinitely extruded along z

2D Transverse Fields

$$\mathbf{B}^a = 0$$

$$E_x^a = -Gx$$

$$E_y^a = Gy$$

$$G \equiv \frac{2V_q}{r_p^2} = -\frac{\partial E_x^a}{\partial x} = \frac{\partial E_y^a}{\partial y}$$

= Electric Gradient

V_q = Pole Voltage

r_p = Pipe Radius
(clear aperture)

//Aside: How can you calculate these fields?

Fields satisfy within vacuum aperture:

$$\begin{aligned}\nabla \cdot \mathbf{E}^a &= 0 \\ \nabla \times \mathbf{E}^a &= 0\end{aligned}\quad \Longrightarrow \quad \mathbf{E}^a = -\nabla \phi^a$$

Choose a long axial structure with 2D hyperbolic potential surfaces:

$$\phi^a = \text{const}(x^2 - y^2)$$

Require: $\phi^a = V_q$ at $x = r_p, y = 0$ \Longrightarrow $\text{const} = V_q/r_p^2$

$$\phi^a = \frac{V_q}{r_p^2}(x^2 - y^2)$$

$$E_x^a = -\frac{\partial \phi^a}{\partial x} = \frac{-2V_q}{r_p^2}x \equiv -Gx$$

$$\Longrightarrow E_y^a = -\frac{\partial \phi^a}{\partial y} = \frac{2V_q}{r_p^2}y \equiv Gy \quad G \equiv \frac{2V_q}{r_p^2}$$

Realistic geometries can be considerably more complicated

- ▶ Truncated hyperbolic electrodes transversely, truncated structure in z

//

Quadrupoles actually have finite axial length in z . Model this by taking the gradient G to vary in s , i.e., $G = G(s)$ with $s = z - z_{\text{center}}$ (straight section)

- ◆ Variation is called the **fringe-field** of the focusing element
- ◆ Variation will violate the Maxwell Equations in 3D
 - Provides a reasonable first approximation in many applications
- ◆ Usually quadrupole is long, and $G(s)$ will have a flat central region and rapid variation near the ends

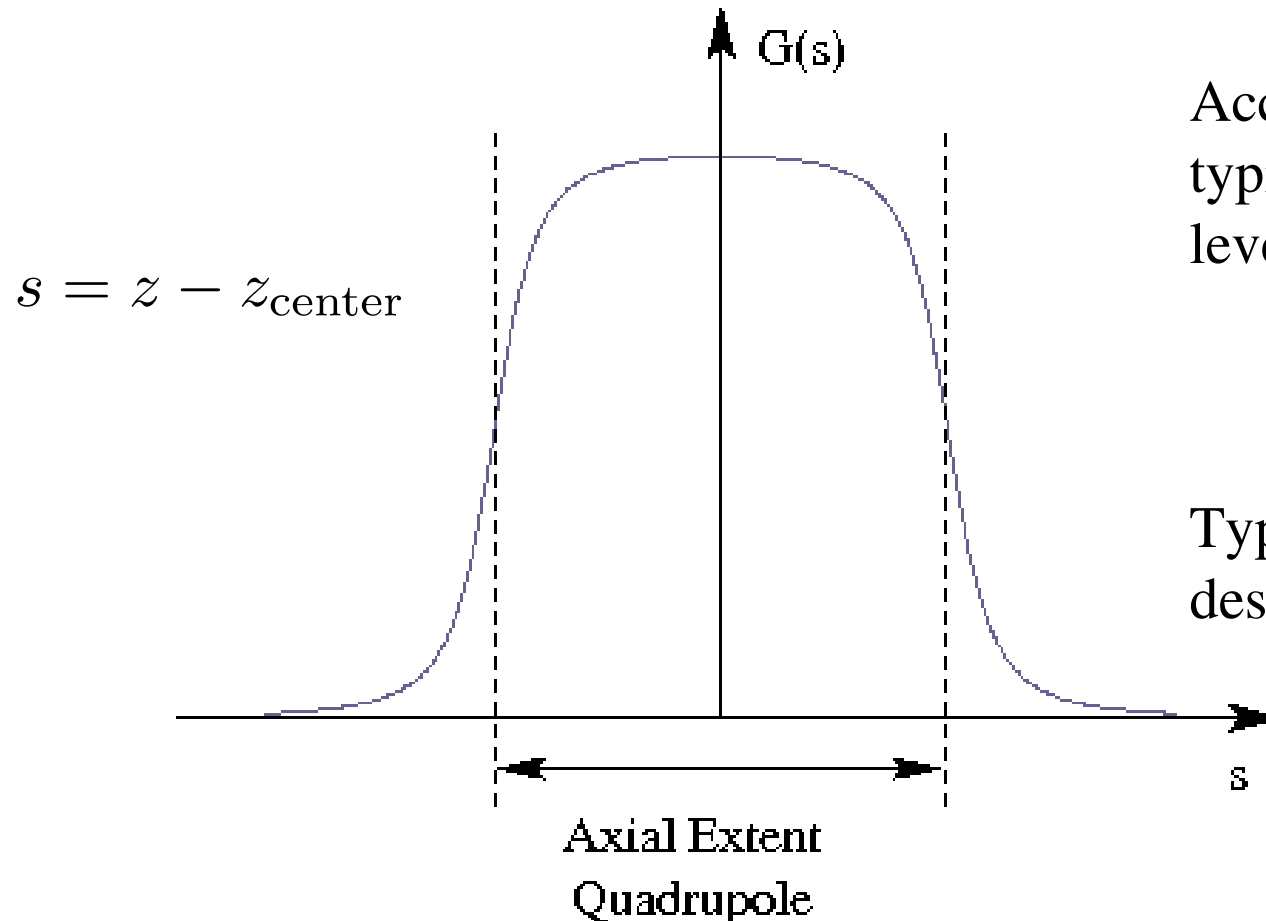

Accurate fringe calculation typically requires higher level modeling:

3D analysis

Detailed geometry

Typically employ magnetic design codes

For many applications the actual quadrupole fringe function $G(s)$ is replaced by a simpler function to allow more idealized modeling

- ◆ Replacements should be made in an “equivalent” parameter sense to be detailed later (see: lectures on **Transverse Centroid and Envelope Modeling**)
- ◆ Fringe functions often replaced in design studies by **piecewise constant** $G(s)$
 - Commonly called “**hard-edge**” approximation
- ◆ See **S3** and Lund and Bukh, PRSTAB 7 924801 (2004), Appendix C for more details on equivalent models

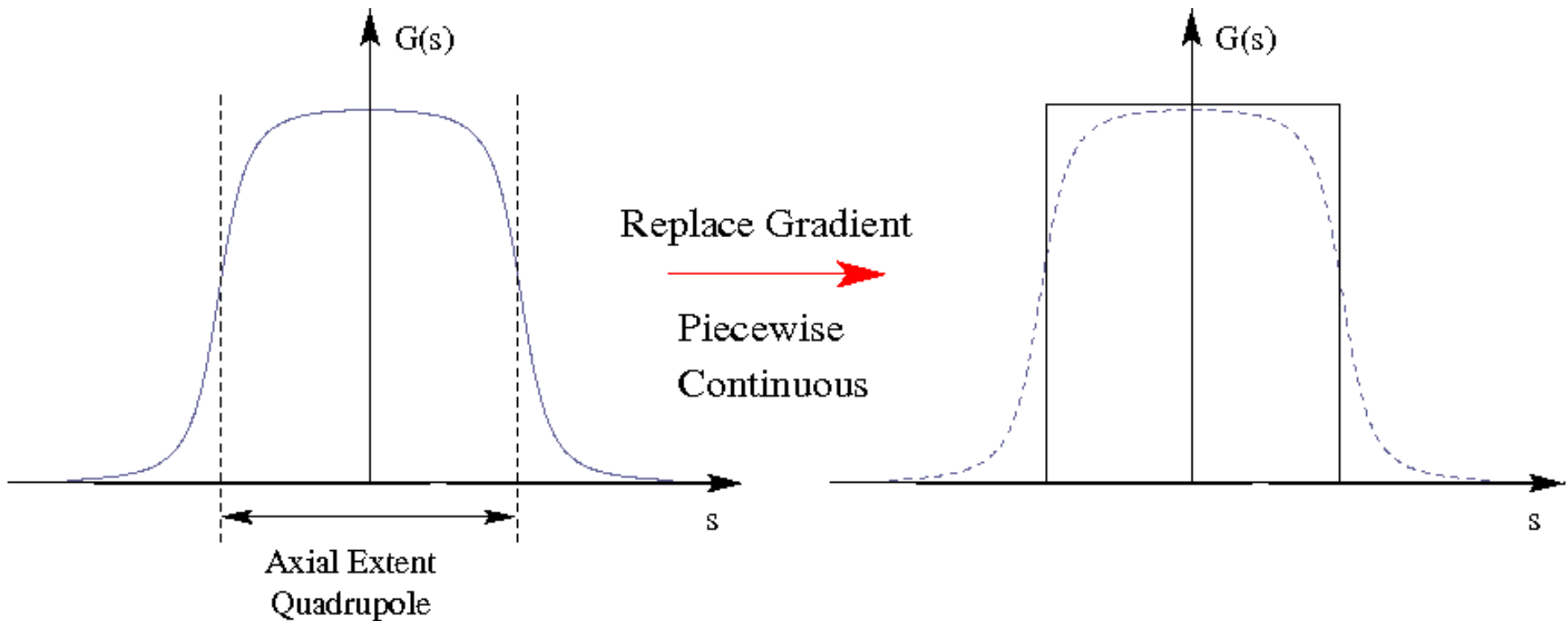

Electric quadrupole equations of motion:

- ◆ Insert applied field components into linear applied field equations and collect terms

$$x'' + \frac{(\gamma_b \beta_b)'}{(\gamma_b \beta_b)} x' + \kappa(s)x = -\frac{q}{m\gamma_b^3 \beta_b^2 c^2} \frac{\partial \phi}{\partial x}$$

$$y'' + \frac{(\gamma_b \beta_b)'}{(\gamma_b \beta_b)} y' - \kappa(s)y = -\frac{q}{m\gamma_b^3 \beta_b^2 c^2} \frac{\partial \phi}{\partial y}$$

$$\kappa(s) = \frac{qG}{m\gamma_b \beta_b^2 c^2} = \frac{G}{\beta_b c [B\rho]}$$

$$G = -\frac{\partial E_x^a}{\partial x} = \frac{\partial E_y^a}{\partial y} = \frac{2V_q}{r_p^2} \quad [B\rho] \equiv \frac{\gamma_b \beta_b m c}{q} = \text{Rigidity}$$
$$\beta_b c [B\rho] \equiv \text{Electric Rigidity}$$

- ◆ For **positive/negative** κ , the applied forces are **Focusing/deFocusing** in the x- and y-planes
- ◆ The x- and y-equations are decoupled
- ◆ Valid whether the the focusing function κ is piecewise constant or incorporates a fringe model

Simple model in limit of no acceleration ($\gamma_b\beta_b \simeq \text{const}$) and negligible space-charge ($\phi \simeq \text{const}$) and $\kappa = \text{const}$:

$$x'' + \kappa x = 0$$

$$y'' - \kappa y = 0$$

\implies orbits harmonic or hyperbolic depending on sign of κ

General solution:

$\kappa > 0$:

$$x = x_i \cos[\sqrt{\kappa}(s - s_i)] + (x'_i/\sqrt{\kappa}) \sin[\sqrt{\kappa}(s - s_i)]$$

$$x' = -\sqrt{\kappa}x_i \sin[\sqrt{\kappa}(s - s_i)] + x'_i \cos[\sqrt{\kappa}(s - s_i)]$$

$$x(s_i) = x_i = \text{Initial coordinate}$$

$$x'(s_i) = x'_i = \text{Initial angle}$$

$$y = y_i \cosh[\sqrt{\kappa}(s - s_i)] + (y'_i/\sqrt{\kappa}) \sinh[\sqrt{\kappa}(s - s_i)]$$

$$y' = \sqrt{\kappa}y_i \sinh[\sqrt{\kappa}(s - s_i)] + y'_i \cosh[\sqrt{\kappa}(s - s_i)]$$

$$y(s_i) = y_i = \text{Initial coordinate}$$

$$y'(s_i) = y'_i = \text{Initial angle}$$

$\kappa < 0$:

Exchange x and y in $\kappa > 0$ case.

In terms of a transfer maps:

$\kappa > 0$:

$$\begin{bmatrix} x \\ x' \end{bmatrix}_s = \mathbf{M}_x(s|s_i) \cdot \begin{bmatrix} x \\ x' \end{bmatrix}_{s_i}$$

$$\begin{bmatrix} y \\ y' \end{bmatrix}_s = \mathbf{M}_y(s|s_i) \cdot \begin{bmatrix} y \\ y' \end{bmatrix}_{s_i}$$

$$\mathbf{M}_x(s|s_i) = \begin{bmatrix} \cos[\sqrt{\kappa}(s - s_i)] & \frac{1}{\sqrt{\kappa}} \sin[\sqrt{\kappa}(s - s_i)] \\ -\sqrt{\kappa} \sin[\sqrt{\kappa}(s - s_i)] & \cos[\sqrt{\kappa}(s - s_i)] \end{bmatrix}$$

$$\mathbf{M}_y(s|s_i) = \begin{bmatrix} \cosh[\sqrt{\kappa}(s - s_i)] & \frac{1}{\sqrt{\kappa}} \sinh[\sqrt{\kappa}(s - s_i)] \\ \sqrt{\kappa} \sinh[\sqrt{\kappa}(s - s_i)] & \cosh[\sqrt{\kappa}(s - s_i)] \end{bmatrix}$$

$\kappa < 0$:

Exchange x and y in $\kappa > 0$ case.

Quadrupoles must be arranged in a lattice where the particles traverse a sequence of optics with **alternating gradient** to focus strongly in both transverse directions

- ◆ Alternating gradient necessary to provide focusing in both x- and y-planes
- ◆ **Alternating Gradient Focusing** often abbreviated “**AG**” and is sometimes called “**Strong Focusing**”
- ◆ FODO is acronym:
 - **F** (Focus) in plane placed where excursions (on average) are small
 - **D** (deFocus) placed where excursions (on average) are large
 - **O** (drift) allows axial separation between elements
- ◆ Focusing lattices often (but not necessarily) periodic
 - Periodic expected to give optimal efficiency in focusing with quadrupoles
- ◆ Drifts between F and D quadrupoles allow space for: acceleration cells, beam diagnostics, vacuum pumping,
- ◆ Focusing strength must be limited for stability (see **S5**)

Example **Quadrupole FODO periodic lattices** with piecewise constant κ

- ◆ FODO: [Focus drift(O) DeFocus Drift(O)] has equal length drifts and same length F and D quadrupoles
- ◆ FODO is simplest possible realization of “alternating gradient” focusing
 - Can also have thin lens limit of finite axial length magnets in FODO lattice

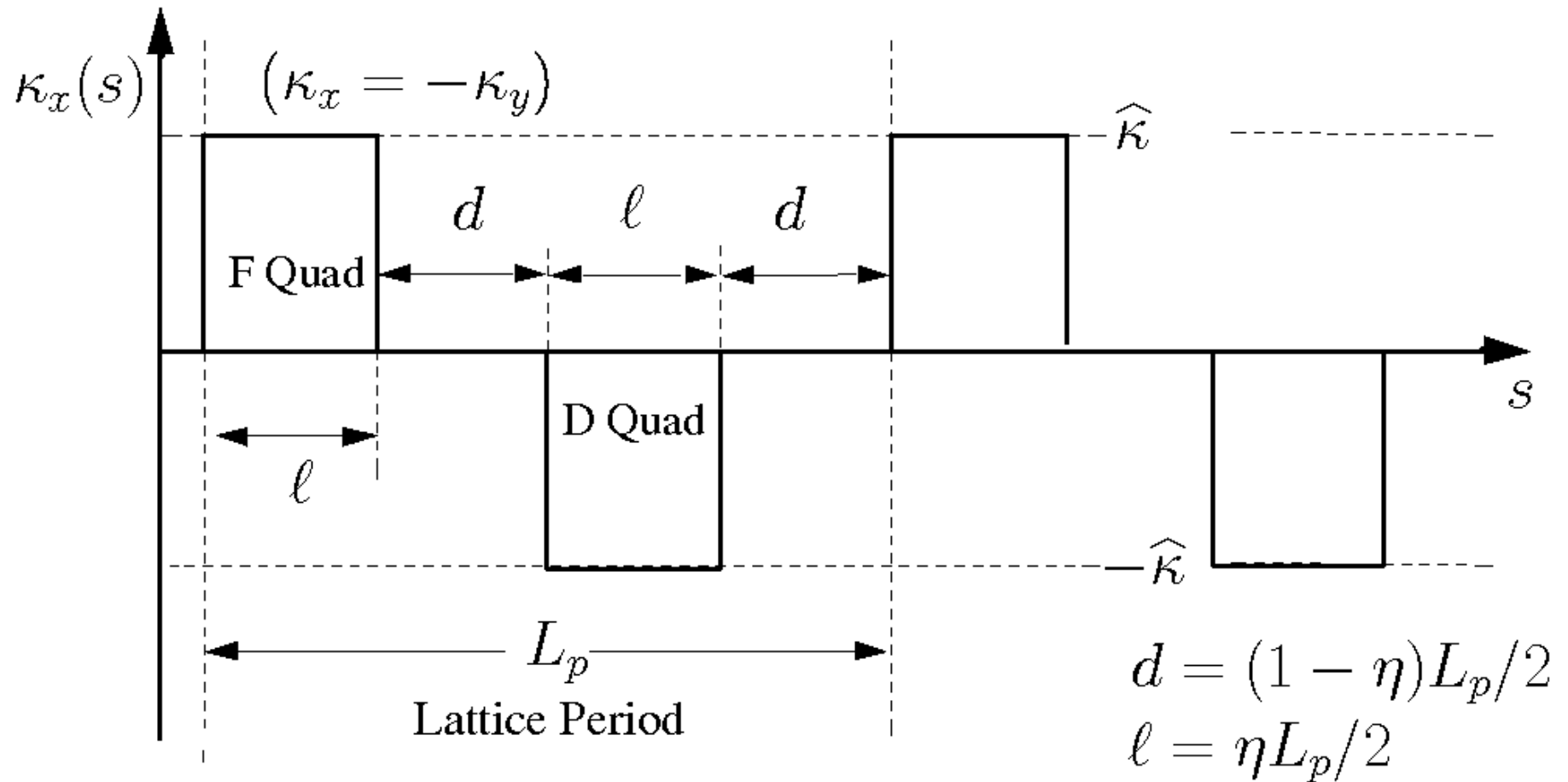

$$\eta = \text{Occupancy} \in (0, 1]$$

/// Example: Particle Orbits in a FODO Periodic Quadrupole Focusing Lattice:

Particle phase-space in x - x' with only hard-edge applied field

$$L_p = 0.5 \text{ m} \quad \kappa = \pm 50 \text{ rad/m}^2 \text{ in Quads} \quad x(0) = 1 \text{ mm} \quad y(0) = 0$$

$$\eta = 0.5 \quad \phi \simeq 0 \quad \gamma_b \beta_b = \text{const} \quad x'(0) = 0 \quad y'(0) = 0$$

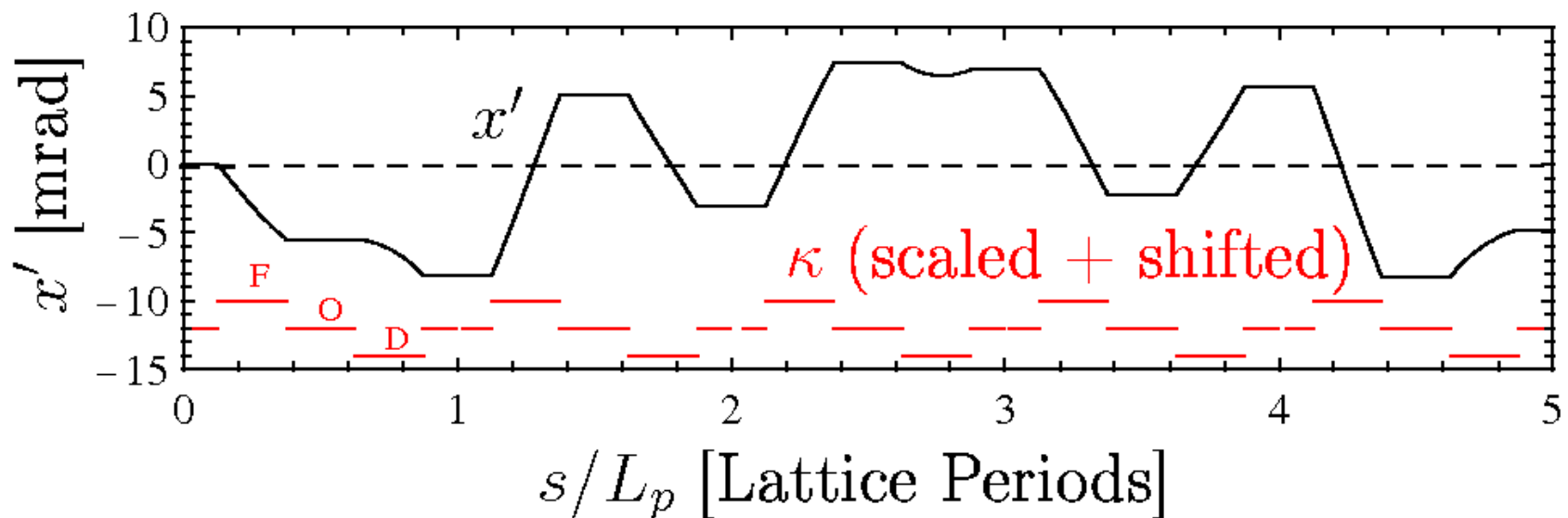
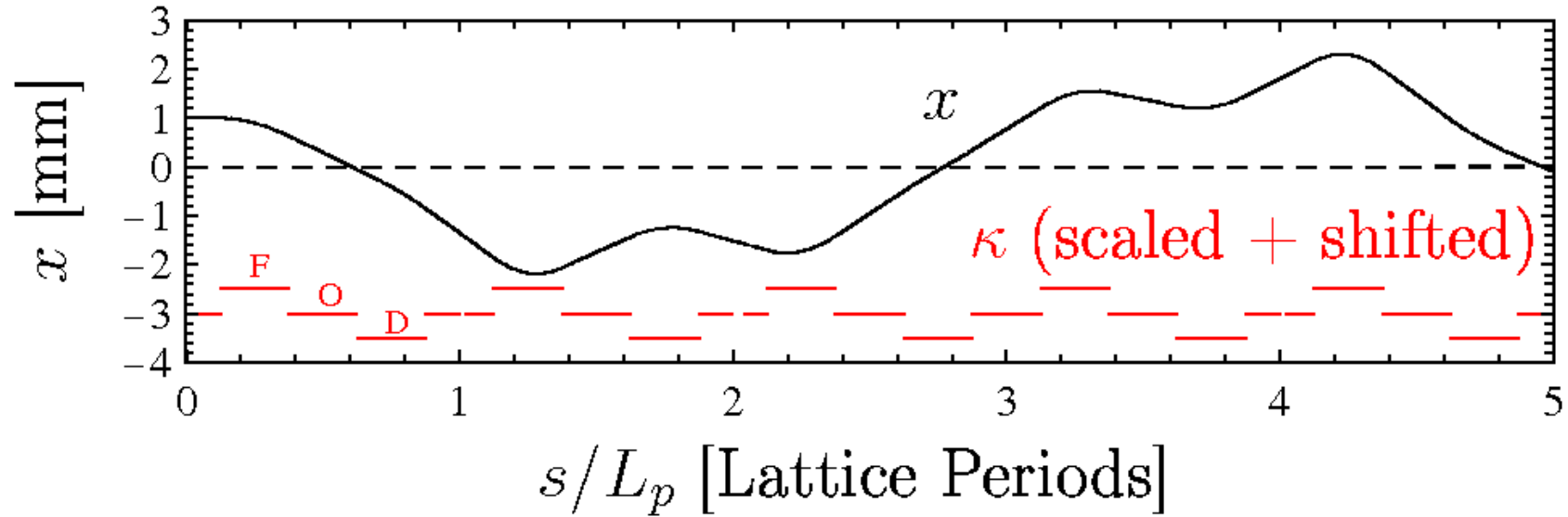

Comments on Orbits:

- ◆ Orbits strongly deviate from simple harmonic form due to AG focusing
 - Multiple harmonics present
- ◆ Orbit tends to be farther from axis in focusing quadrupoles and closer to axis in defocusing quadrupoles to provide net focusing
- ◆ Will find later that if the focusing is sufficiently strong, the orbit can become unstable (see: S5)
- ◆ y-orbit has the same properties as x-orbit due to the periodic structure and AG focusing
- ◆ If quadrupoles are rotated about their z-axis of symmetry, then the x- and y-equations become cross-coupled. This is called quadrupole skew coupling (see: Appendix A) and complicates the dynamics.

Some properties of particle orbits in quadrupoles with $\kappa = \text{const}$ will be analyzed in the problem sets

S2D: Alternating Gradient Quadrupole Focusing

Magnetic Quadrupoles

In the axial center of a long magnetic quadrupole, model fields as 2D transverse

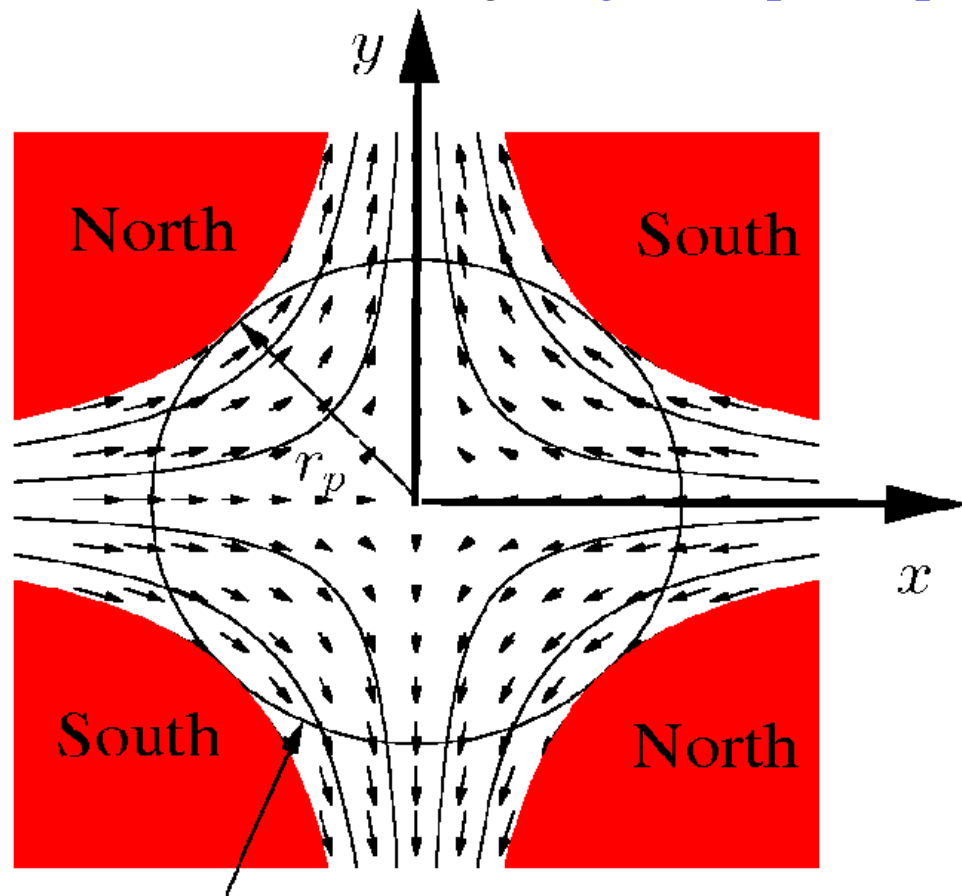

Conducting Beam Pipe: $r = r_p$
 Poles: $xy = \pm \frac{r_p^2}{2}$

- ◆ Magnetic (ideal iron) poles hyperbolic
- ◆ Structure infinitely extruded along z

2D Transverse Fields

$$\mathbf{E}_{\perp}^a = 0$$

$$B_x^a = Gy$$

$$B_y^a = Gx$$

$$B_z^a = 0$$

$$G \equiv \frac{B_q}{r_p} = \frac{\partial B_x^a}{\partial y} = \frac{\partial B_y^a}{\partial x}$$

= Magnetic Gradient

$$B_q = |\mathbf{B}^a|_{r=r_p} = \text{Pole Field}$$

$$r_p = \text{Pipe Radius}$$

//Aside: How can you calculate these fields?

Fields satisfy within vacuum aperture:

$$\begin{aligned}\nabla \cdot \mathbf{B}^a &= 0 \\ \nabla \times \mathbf{B}^a &= 0\end{aligned}\quad \Longrightarrow \quad \mathbf{B}^a = -\nabla \phi^a$$

Analogous to electric case, BUT magnetic force is different so rotate potential surfaces by 45 degrees:

Electric

$$\mathbf{F}_\perp = -q \frac{\partial \phi^a}{\partial \mathbf{x}_\perp}$$

$$\phi^a = \text{const}(x^2 - y^2)$$

Magnetic

$$\mathbf{F}_\perp = -q\beta_b c \hat{\mathbf{z}} \times \frac{\partial \phi^a}{\partial \mathbf{x}_\perp}$$

expect electric potential form rotated by 45 degrees ...

$$x \rightarrow \frac{1}{\sqrt{2}}x - \frac{1}{\sqrt{2}}y$$

$$y \rightarrow \frac{1}{\sqrt{2}}x + \frac{1}{\sqrt{2}}y$$

$$\phi^a \rightarrow \phi^a = -\text{const} \cdot xy$$

$$\begin{aligned} B_x^a &= -\frac{\partial \phi^a}{\partial x} = \text{const} \cdot y \\ \implies B_y^a &= -\frac{\partial \phi^a}{\partial y} = \text{const} \cdot x \end{aligned}$$

Require: $|\mathbf{B}^a| = B_p$ at $r = \sqrt{x^2 + y^2} = r_p \implies \text{const} = B_p/r_p$

$$\implies \phi^a = -\frac{B_p}{r_p}xy \qquad G = \frac{B_p}{r_p}$$

Realistic geometries can be considerably more complicated

- ◆ Truncated hyperbolic poles, truncated structure in z
- ◆ Both effects give nonlinear focusing terms

Analogously to the electric quadrupole case, take $G = G(s)$

- ◆ Same comments made on electric quadrupole fringe in **S2C** are directly applicable to magnetic quadrupoles

Magnetic quadrupole equations of motion:

- ◆ Insert field components into linear applied field equations and collect terms

$$x'' + \frac{(\gamma_b \beta_b)'}{(\gamma_b \beta_b)} x' + \kappa(s)x = -\frac{q}{m\gamma_b^3 \beta_b^2 c^2} \frac{\partial \phi}{\partial x}$$

$$y'' + \frac{(\gamma_b \beta_b)'}{(\gamma_b \beta_b)} y' - \kappa(s)y = -\frac{q}{m\gamma_b^3 \beta_b^2 c^2} \frac{\partial \phi}{\partial y}$$

$$\kappa(s) = \frac{qG}{m\gamma_b \beta_b c} = \frac{G}{[B\rho]}$$

$$G = \frac{\partial B_x^a}{\partial y} = \frac{\partial B_y^a}{\partial x} = \frac{B_q}{r_p} \quad [B\rho] \equiv \frac{\gamma_b \beta_b m c}{q} = \text{Rigidity}$$

- ◆ Equations identical to the electric quadrupole case in terms of $\kappa(s)$
- ◆ All comments made on electric quadrupole focusing lattice are immediately applicable to magnetic quadrupoles: just apply different κ definitions in design
- ◆ Scaling of κ with energy different than electric case impacts applicability

$$\kappa = \begin{cases} \frac{G}{\beta_b c [B\rho]} & \text{Electric Focusing; } G = \frac{\partial E_y^a}{\partial y} = \frac{2V_q}{r_p^2} \\ \frac{G}{[B\rho]} & \text{Magnetic Focusing; } G = \frac{\partial B_x^a}{\partial y} = \frac{B_q}{r_p} \end{cases}$$

- ◆ Electric focusing weaker for higher particle energy (larger β_b)
- ◆ Technical limit values of gradients
 - Voltage holding for electric
 - Material properties (iron saturation, superconductor limits, ...) for magnetic
- ◆ See **JJB Intro** lectures for discussion on focusing technology choices

Different energy dependence also gives different **dispersive properties** when beam has axial momentum spread:

$$\delta \equiv \frac{\delta p}{p_0} = \text{Fractional Momentum Error}$$

$$\kappa \rightarrow \begin{cases} \frac{\kappa}{(1+\delta)^2} & \text{Electric Focusing} \\ \frac{\kappa}{1+\delta} & \text{Magnetic Focusing} \end{cases}$$

- ◆ Electric case further complicated because δ couples to the transverse motion since particles crossing higher electrostatic potentials are accelerated/deaccelerated

S2E: Solenoidal Focusing

The field of an ideal **magnetic solenoid** is invariant under transverse rotations about its axis of symmetry (z) can be expanded in terms of the on-axis field as as:

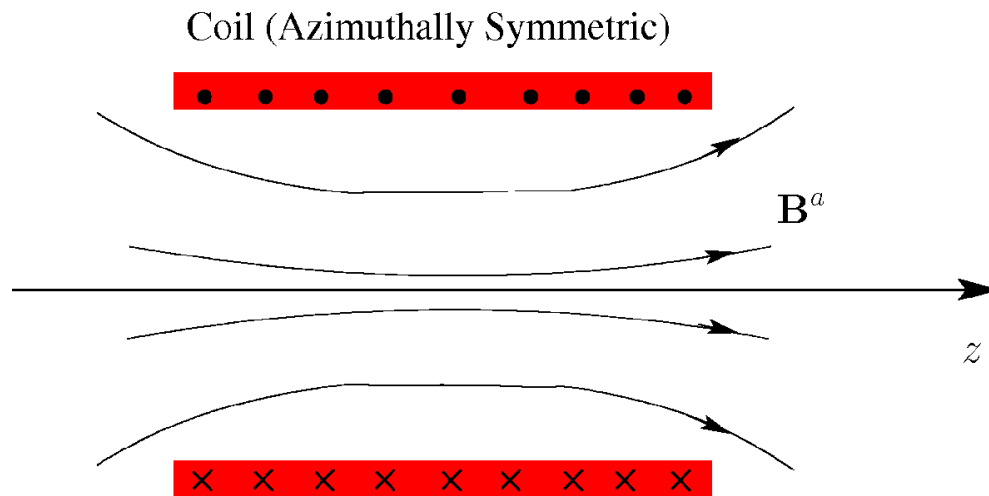

Vacuum Maxwell equations:

$$\nabla \cdot \mathbf{B}^a = 0$$

$$\nabla \times \mathbf{B}^a = 0$$

Imply \mathbf{B}^a can be expressed in terms of on-axis field $\mathbf{B}_z^a(r=0, z)$

$$\mathbf{E}^a = 0$$

$$\mathbf{B}_\perp^a = \frac{1}{2} \sum_{\nu=1}^{\infty} \frac{(-1)^\nu}{\nu!(\nu-1)!} \frac{\partial^{2\nu-1} B_{z0}(z)}{\partial z^{2\nu-1}} \left(\frac{|\mathbf{x}_\perp|}{2} \right)^{2\nu-2} \mathbf{x}_\perp$$

$$B_z^a = B_{z0}(z) + \sum_{\nu=1}^{\infty} \frac{(-1)^\nu}{(\nu!)^2} \frac{\partial^{2\nu} B_{z0}(z)}{\partial z^{2\nu}} \left(\frac{|\mathbf{x}_\perp|}{2} \right)^{2\nu}$$

$$B_{z0}(z) \equiv B_z^a(\mathbf{x}_\perp = 0, z) = \text{On-Axis Field}$$

See
Appendix D
 or
 Reiser,
*Theory and Design
 of Charged
 Particle Beams*,
 Sec. 3.3.1

Writing out explicitly the terms of this expansion:

$$\mathbf{B}^a(r, z) = \hat{\mathbf{r}}B_r^a(r, z) + \hat{\mathbf{z}}B_z^a(r, z) \quad r = \sqrt{x^2 + y^2}$$

$$= (-\hat{\mathbf{x}} \sin \theta + \hat{\mathbf{y}} \cos \theta)B_r^a(r, z) + \hat{\mathbf{z}}B_z^a(r, z)$$

where

$$B_r^a(r, z) = \sum_{\nu=1}^{\infty} \frac{(-1)^\nu}{\nu!(\nu-1)!} B_{z0}^{(2\nu-1)}(z) \left(\frac{r}{2}\right)^{2\nu-1}$$

$$= -\frac{B'_{z0}(z)}{2}r + \frac{B_{z0}^{(3)}(z)}{16}r^3 - \frac{B_{z0}^{(5)}(z)}{384}r^5 + \frac{B_{z0}^{(7)}(z)}{18432}r^7 - \frac{B_{z0}^{(9)}(z)}{1474560}r^9 + \dots$$

$$B_z^a(r, z) = \sum_{\nu=0}^{\infty} \frac{(-1)^\nu}{(\nu!)^2} B_{z0}^{(2\nu)}(z) \left(\frac{r}{2}\right)^{2\nu}$$

$$= B_{z0}(z) - \frac{B''_{z0}(z)}{4}r^2 + \frac{B_{z0}^{(4)}(z)}{64}r^4 - \frac{B_{z0}^{(6)}(z)}{2304}r^6 + \frac{B_{z0}^{(8)}(z)}{147456}r^8 + \dots$$

$B_{z0}(z) \equiv B_z^a(r=0, z) =$ On-axis Field

...

Linear Terms

$$B_{z0}^{(n)}(z) \equiv \frac{\partial^n B_{z0}(z)}{\partial z^n} \quad B'_{z0}(z) \equiv \frac{\partial B_{z0}(z)}{\partial z} \quad B''_{z0}(z) \equiv \frac{\partial^2 B_{z0}(z)}{\partial z^2}$$

For modeling, we truncate the expansion using only leading-order terms to obtain:

- Corresponds to **linear dynamics** in the equations of motion

$$\begin{aligned} B_x^a &= -\frac{1}{2} \frac{\partial B_{z0}(z)}{\partial z} x \\ B_y^a &= -\frac{1}{2} \frac{\partial B_{z0}(z)}{\partial z} y & B_{z0}(z) &\equiv B_z^a(\mathbf{x}_\perp = 0, z) \\ B_z^a &= B_{z0}(z) & &= \text{On-Axis Field} \end{aligned}$$

Note that this truncated expansion is **divergence free**:

$$\nabla \cdot \mathbf{B}^a = -\frac{1}{2} \frac{\partial B_{z0}}{\partial z} \frac{\partial}{\partial \mathbf{x}_\perp} \cdot \mathbf{x}_\perp + \frac{\partial}{\partial z} B_{z0} = 0$$

but not curl free within the vacuum aperture:

$$\begin{aligned} \nabla \times \mathbf{B}^a &= \frac{1}{2} \frac{\partial^2 B_{z0}(z)}{\partial z^2} (-\hat{\mathbf{x}}y + \hat{\mathbf{y}}x) \\ &= \frac{1}{2} \frac{\partial^2 B_{z0}(z)}{\partial z^2} r(-\hat{\mathbf{x}} \sin \theta + \hat{\mathbf{y}} \cos \theta) = \frac{1}{2} \frac{\partial^2 B_{z0}(z)}{\partial z^2} r \hat{\theta} \end{aligned}$$

- Nonlinear terms needed to satisfy 3D Maxwell equations

Solenoid equations of motion:

- ◆ Insert field components into equations of motion and collect terms

$$x'' + \frac{(\gamma_b \beta_b)'}{(\gamma_b \beta_b)} x' - \frac{B'_{z0}(s)}{2[B\rho]} y - \frac{B_{z0}(s)}{[B\rho]} y' = -\frac{q}{m\gamma_b^3 \beta_b^2 c^2} \frac{\partial \phi}{\partial x}$$

$$y'' + \frac{(\gamma_b \beta_b)'}{(\gamma_b \beta_b)} y' + \frac{B'_{z0}(s)}{2[B\rho]} x + \frac{B_{z0}(s)}{[B\rho]} x' = -\frac{q}{m\gamma_b^3 \beta_b^2 c^2} \frac{\partial \phi}{\partial y}$$

$$[B\rho] \equiv \frac{\gamma_b \beta_b m c}{q} = \text{Rigidity} \qquad \frac{B_{z0}(s)}{[B\rho]} = \frac{\omega_c(s)}{\gamma_b \beta_b c}$$

$$\omega_c(s) = \frac{q B_{z0}(s)}{m} = \text{Cyclotron Frequency} \\ \text{(in applied axial magnetic field)}$$

- ◆ Equations are linearly **cross-coupled** in the applied field terms
 - x equation depends on y, y'
 - y equation depends on x, x'

It can be shown (see: **Appendix B**) that the linear cross-coupling in the applied field can be removed by an s-varying transformation to a rotating “Larmor” frame:

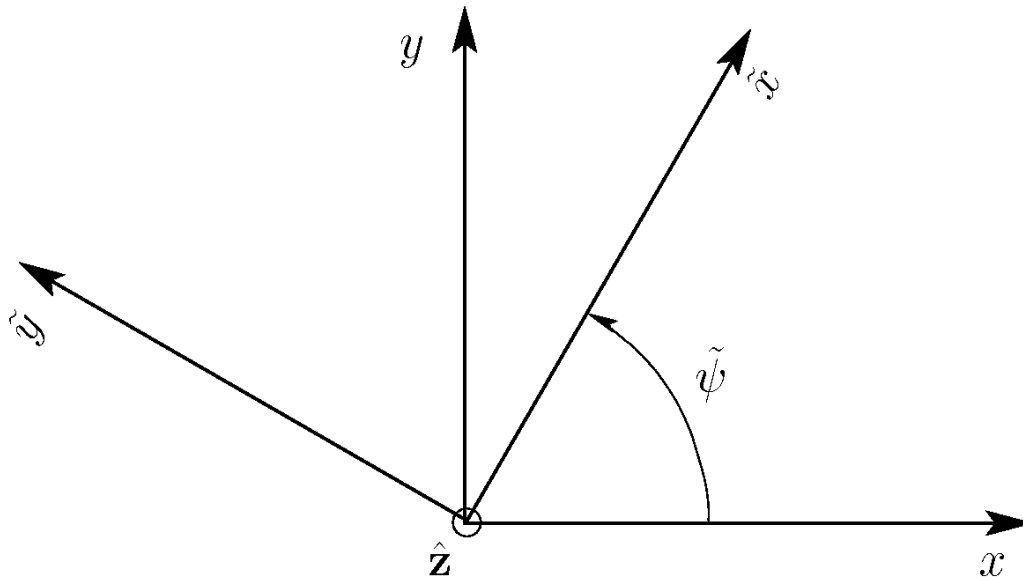

$$\tilde{x} = x \cos \tilde{\psi}(s) + y \sin \tilde{\psi}(s)$$

$$\tilde{y} = -x \sin \tilde{\psi}(s) + y \cos \tilde{\psi}(s)$$

$$\tilde{\psi}(s) = - \int_{s_i}^s d\bar{s} k_L(\bar{s})$$

$$k_L(s) \equiv \frac{B_{z0}(s)}{2[B\rho]} = \frac{\omega_c(s)}{2\gamma_b\beta_b c}$$

= Larmor
wave number

$s = s_i$ defines
initial condition

... used to denote
rotating frame variables

If the beam space-charge is *axisymmetric*:

$$\frac{\partial \phi}{\partial \mathbf{x}_\perp} = \frac{\partial \phi}{\partial r} \frac{\partial r}{\partial \mathbf{x}_\perp} = \frac{\partial \phi}{\partial r} \frac{\mathbf{x}_\perp}{r}$$

then the space-charge term also decouples under the **Larmor transformation** and the equations of motion can be expressed in fully **uncoupled form**:

$$\tilde{x}'' + \frac{(\gamma_b \beta_b)'}{(\gamma_b \beta_b)} \tilde{x}' + \kappa(s) \tilde{x} = - \frac{q}{m \gamma_b^3 \beta_b^2 c^2} \frac{\partial \phi}{\partial r} \frac{\tilde{x}}{r}$$

$$\tilde{y}'' + \frac{(\gamma_b \beta_b)'}{(\gamma_b \beta_b)} \tilde{y}' + \kappa(s) \tilde{y} = - \frac{q}{m \gamma_b^3 \beta_b^2 c^2} \frac{\partial \phi}{\partial r} \frac{\tilde{y}}{r}$$

$$\kappa(s) = k_L^2(s) \equiv \left[\frac{B_{z0}(s)}{2[B\rho]} \right]^2 = \left[\frac{\omega_c(s)}{2\gamma_b \beta_b c} \right]^2$$

Will demonstrate this in problems for the simple case of:

$$B_{z0}(s) = \text{const}$$

- Because Larmor frame equations are in the same form as continuous and quadrupole focusing with a different κ , for solenoidal focusing we implicitly work in the Larmor frame and simplify notation by dropping the tildes:

$$\tilde{\mathbf{x}}_\perp \rightarrow \mathbf{x}_\perp$$

/// Aside: Notation:

A common theme of this class will be to introduce new effects and generalizations while keeping formulations looking **as similar as possible** to the the most simple representations given. When doing so, we will often use “tildes” to denote transformed variables to stress that the new coordinates have, in fact, a more complicated form that must be interpreted in the context of the analysis being carried out. Some examples:

- ◆ Larmor frame transformations for Solenoidal focusing
See: **Appendix B**
- ◆ Normalized variables for analysis of accelerating systems
See: **S10**

///

Solenoid periodic lattices can be formed similarly to the quadrupole case

- ◆ Drifts placed between solenoids of finite axial length
 - Allows space for diagnostics, pumping, acceleration cells, etc.
- ◆ Analogous equivalence cases to quadrupole
 - Piecewise constant κ often used
- ◆ Fringe can be more important for solenoids

Simple hard-edge solenoid lattice with piecewise constant κ

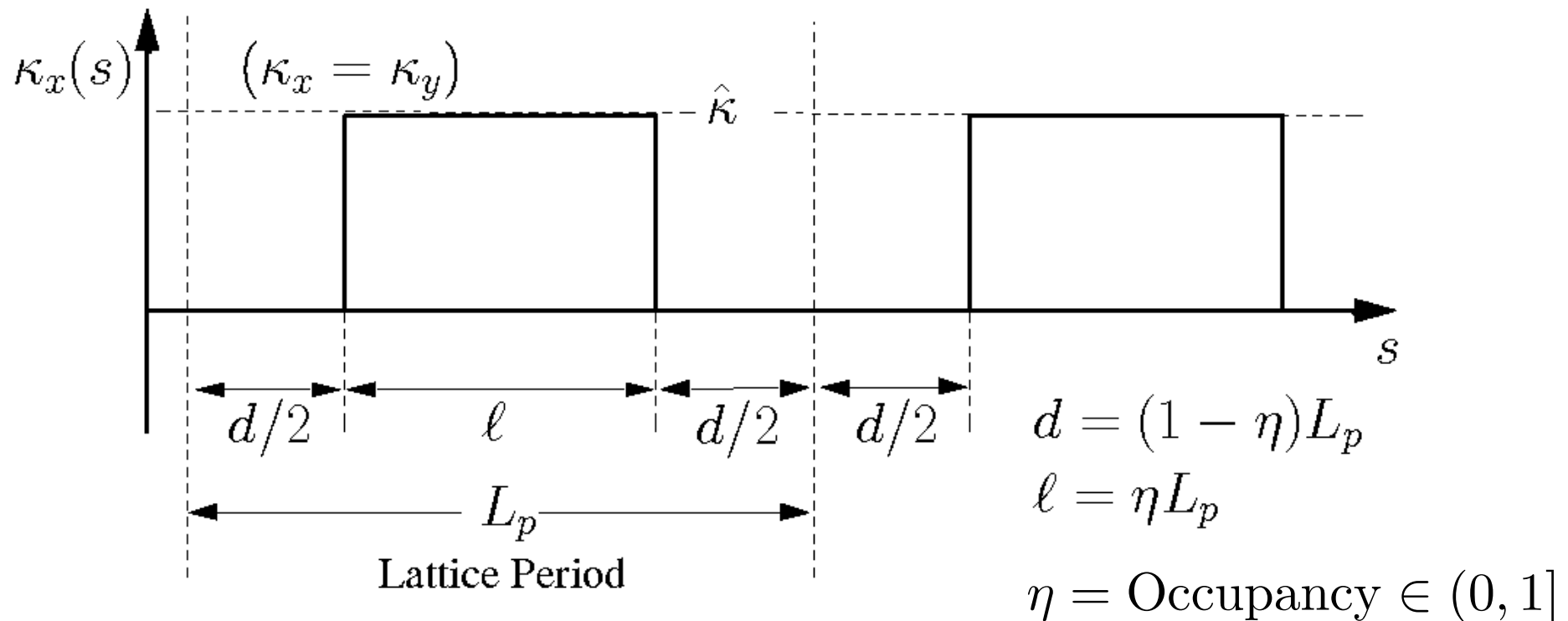

/// Example: Larmor Frame Particle Orbits in a Periodic Solenoidal Focusing

Lattice: $\tilde{x} - \tilde{x}'$ phase-space for hard edge elements and applied fields

$$L_p = 0.5 \text{ m} \quad \kappa = 20 \text{ rad/m}^2 \text{ in Solenoids} \quad \tilde{x}(0) = 1 \text{ mm} \quad \tilde{y}(0) = 0$$

$$\eta = 0.5 \quad \phi \simeq 0 \quad \gamma_b \beta_b = \text{const} \quad \tilde{x}'(0) = 0 \quad \tilde{y}'(0) = 0$$

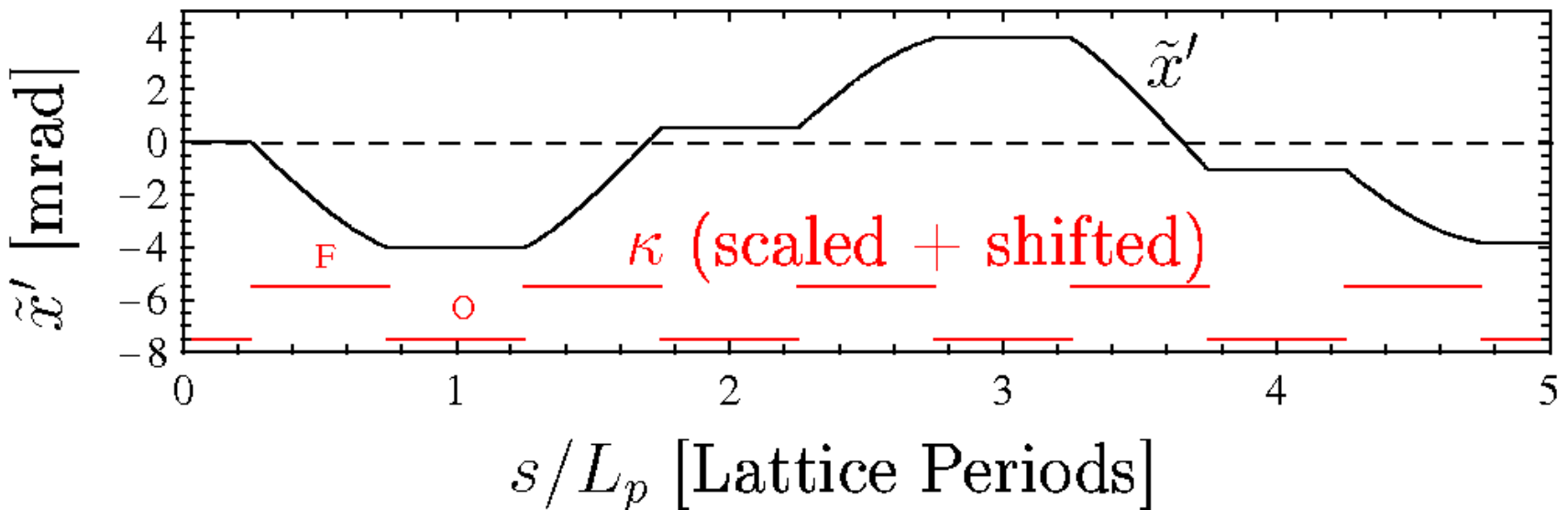
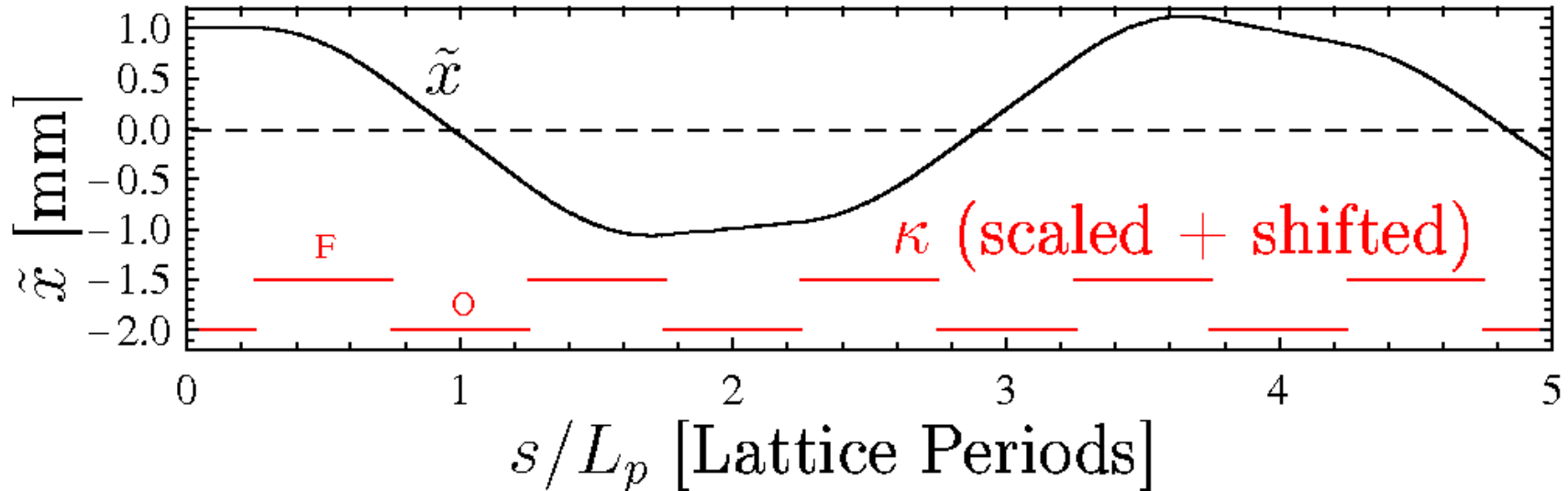

Contrast of Larmor-Frame and Lab-Frame Orbits

- ◆ Same initial condition

Larmor-Frame Coordinate Orbit in transformed x-plane only

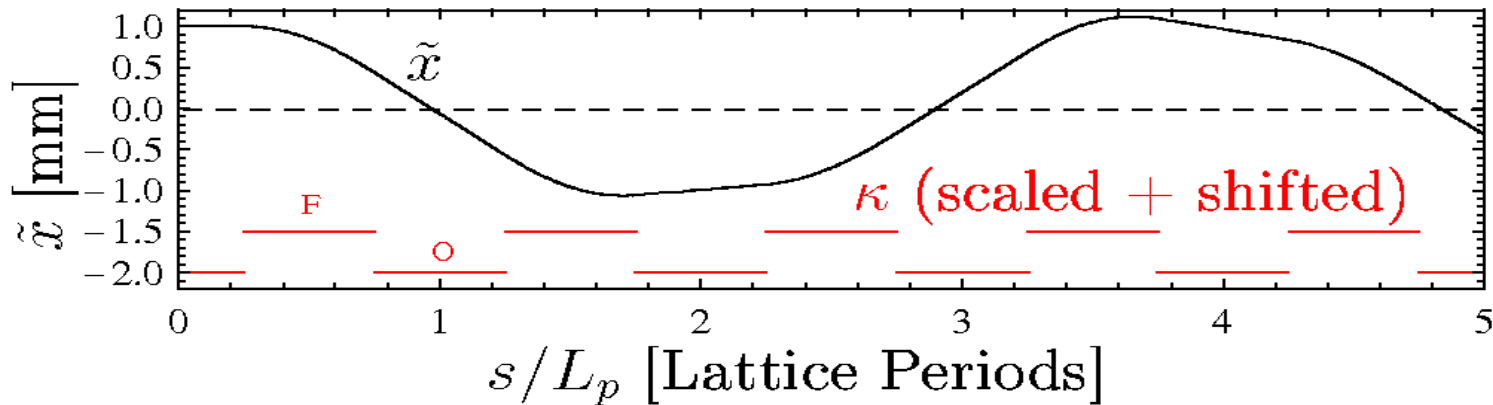

Lab-Frame Coordinate Orbit in both x- and y-planes

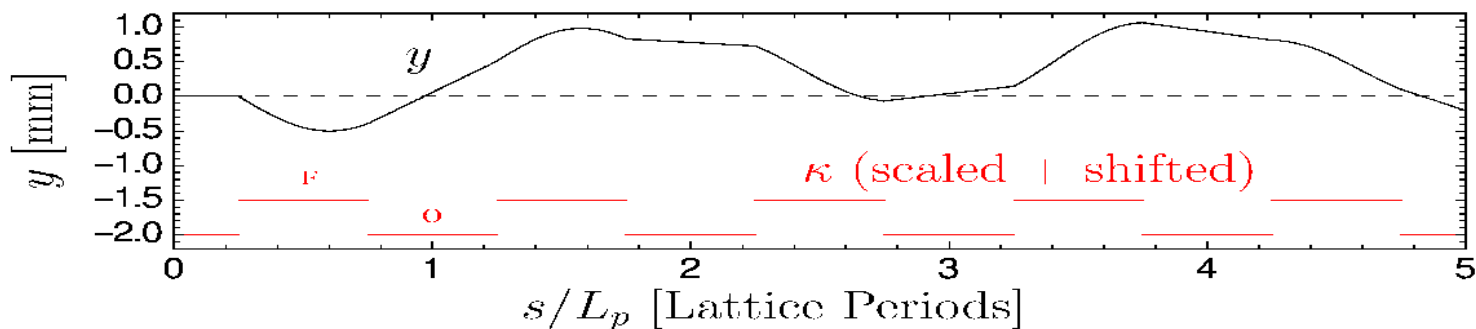
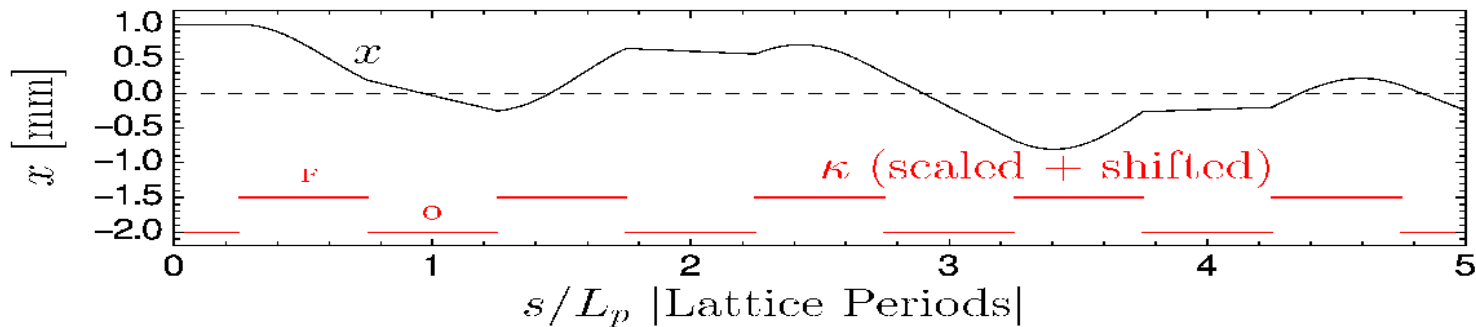

Calculate using transfer matrices in **Appendix C**

Contrast of Larmor-Frame and Lab-Frame Orbits

- ◆ Same initial condition

Larmor-Frame Angle

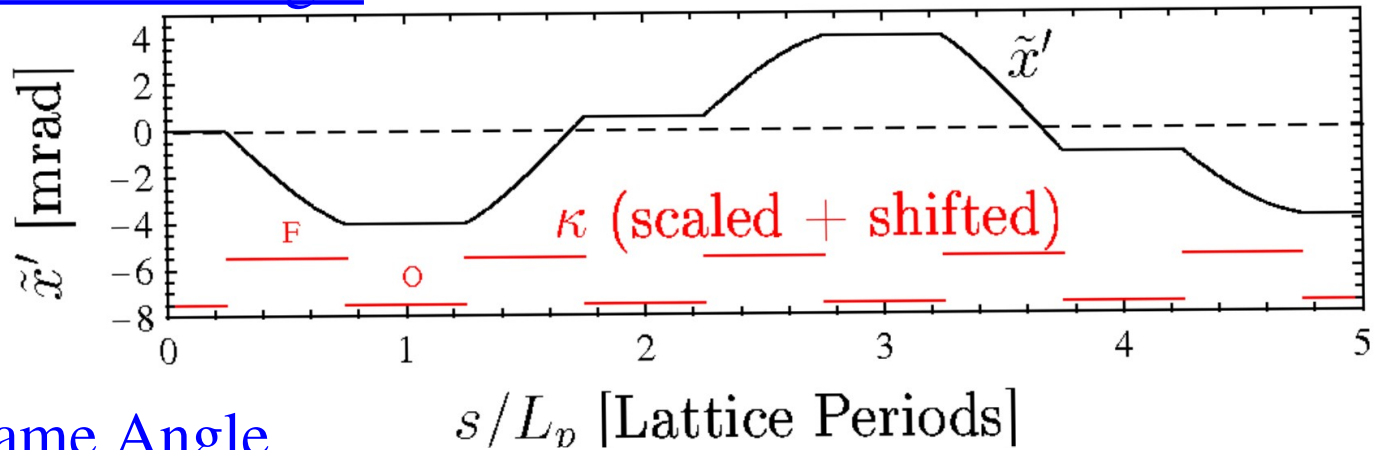

Lab-Frame Angle

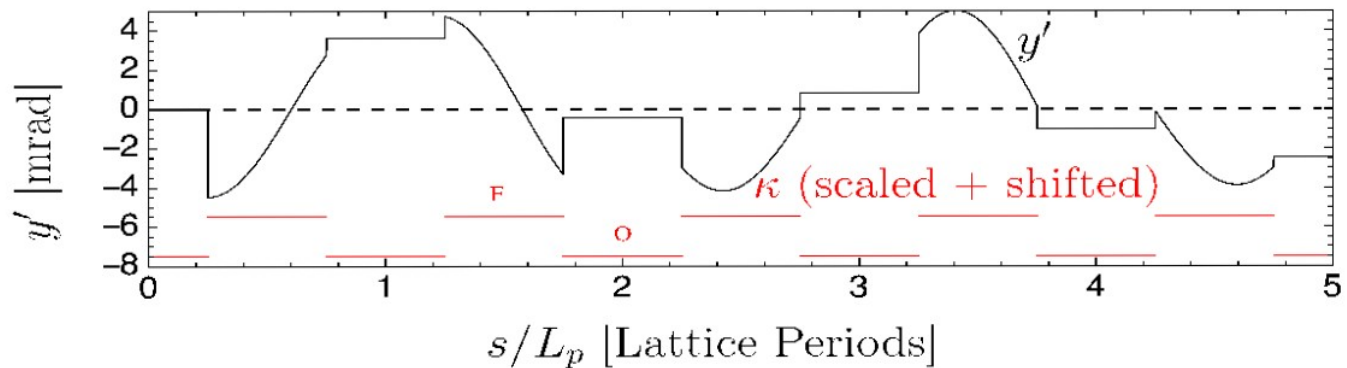
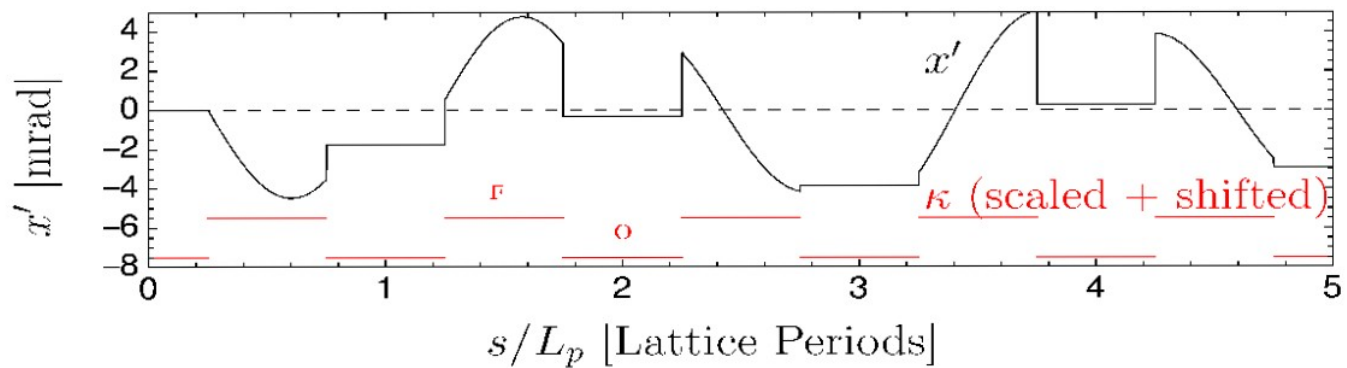

Calculate
using
transfer
matrices in
Appendix C

Additional perspectives of particle orbit in solenoid transport channel

- ◆ Same initial condition

Radius evolution (Lab or Larmor Frame: radius same)

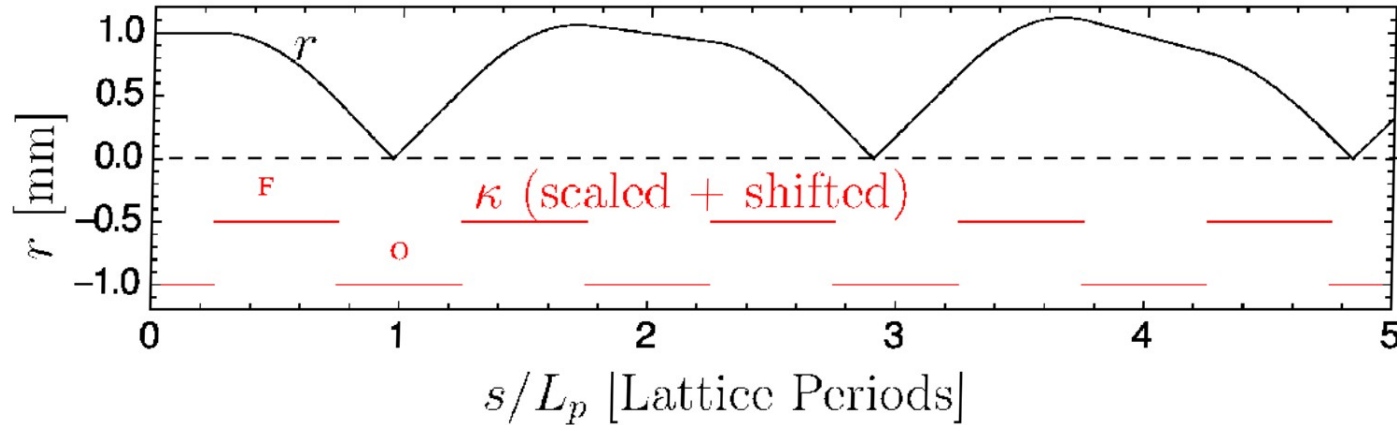

Side- (2 view points) and End-View Projections of 3D Lab-Frame Orbit

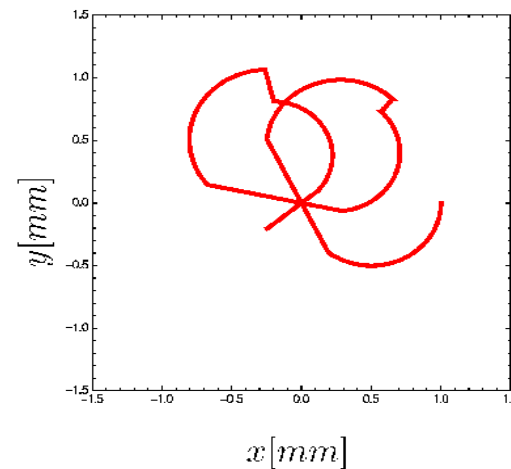
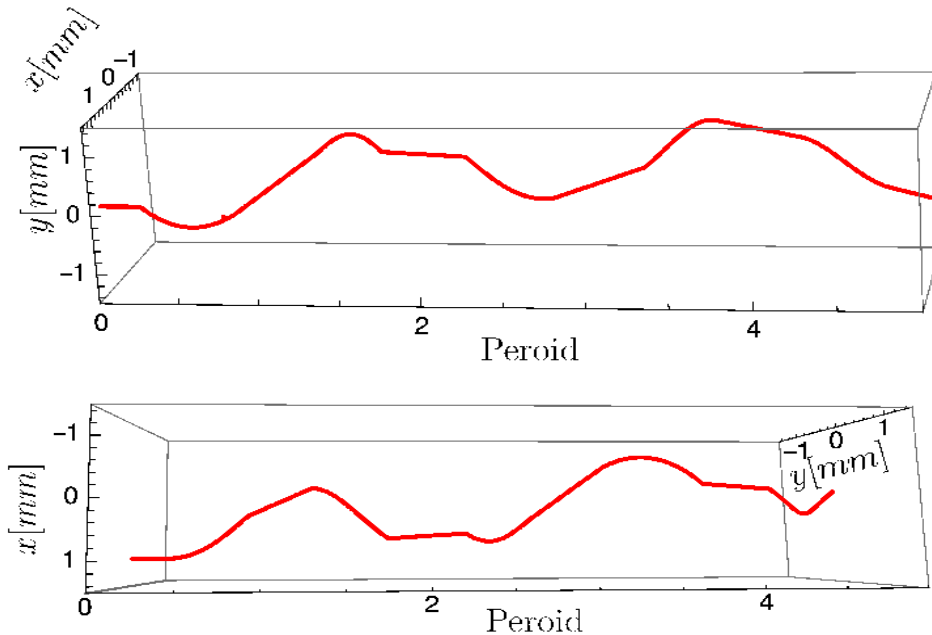

Calculate using transfer matrices in **Appendix C**

Larmor angle and angular momentum of particle orbit in solenoid transport channel

◆ Same initial condition

Larmor Angle

$$\tilde{\psi}(s) = - \int_{s_i}^s d\bar{s} k_L(\bar{s}) \quad k_L(s) \equiv \frac{B_{z0}(s)}{2[B\rho]}$$

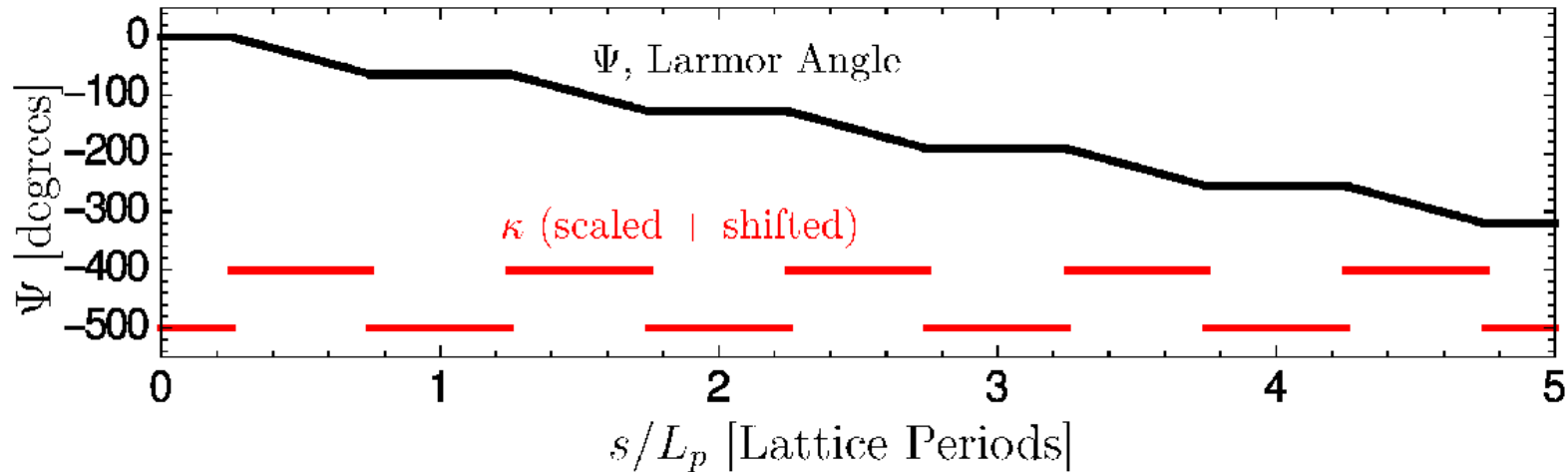

Angular Momentum and Canonical Angular Momentum (see Sec. S2G)

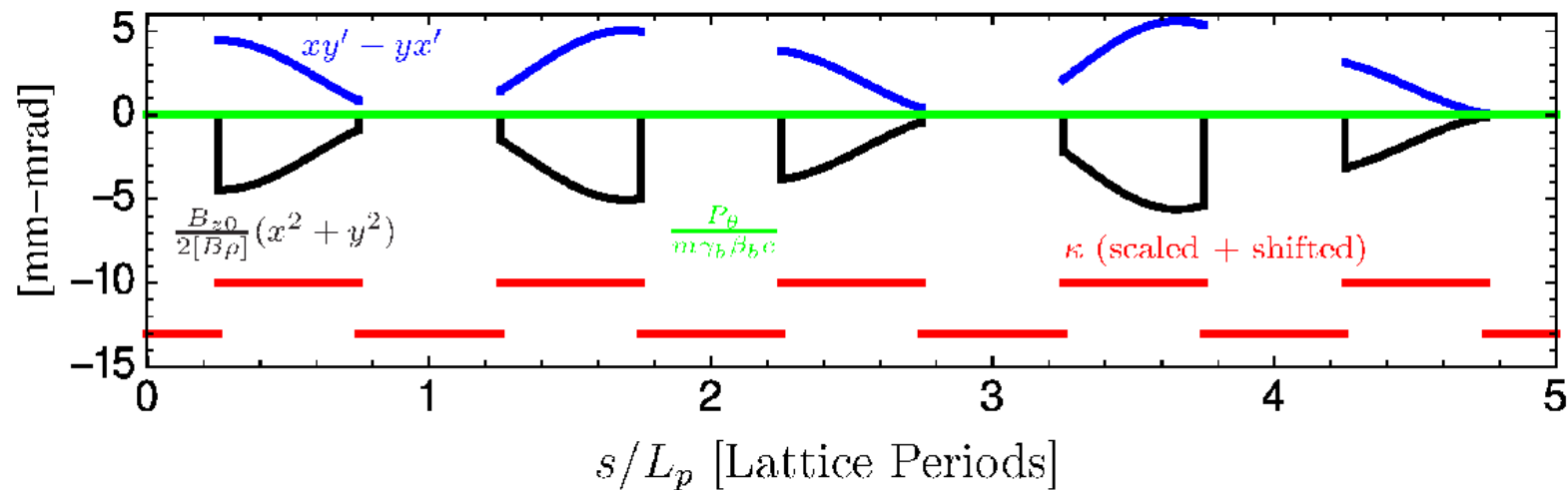

///

Comments on Orbits:

- ◆ See [Appendix C](#) for details on calculation
 - Discontinuous fringe of hard-edge model must be treated carefully if integrating in the laboratory-frame.
- ◆ Larmor-frame orbits strongly deviate from simple harmonic form due to periodic focusing
 - Multiple harmonics present
 - Less complicated than quadrupole AG focusing case when interpreted in the Larmor frame due to the optic being focusing in both planes
- ◆ Orbits transformed back into the Laboratory frame using Larmor transform (see: [Appendix B](#) and [Appendix C](#))
 - Laboratory frame orbit exhibits more complicated x - y plane coupled oscillatory structure
- ◆ Will find later that if the focusing is sufficiently strong, the orbit can become unstable (see: [S5](#))
- ◆ Larmor frame y -orbits have same properties as the x -orbits due to the equations being decoupled and identical in form in each plane
 - In example, Larmor y -orbit is zero due to simple initial condition in x -plane
 - Lab y -orbit is nonzero due to x - y coupling

Comments on Orbits (continued):

- ◆ Larmor angle advances continuously even for hard-edge focusing
- ◆ Mechanical angular momentum jumps discontinuously going into and out of the solenoid
 - Particle spins up and down going into and out of the solenoid
 - No mechanical angular momentum outside of solenoid due to the choice of initial condition in this example (initial x -plane motion)
- ◆ Canonical angular momentum P_θ is conserved in the 3D orbit evolution
 - As expected from analysis in [S2G](#)
 - Invariance provides a good check on dynamics
 - P_θ in example has zero value due to the specific (x -plane) choice of initial condition. Other choices can give nonzero values and finite mechanical angular momentum in drifts.

Some properties of particle orbits in solenoids with piecewise $\kappa = \text{const}$ will be analyzed in the problem sets



S2F: Summary of Transverse Particle Equations of Motion

In linear applied focusing channels, without momentum spread or radiation, the particle equations of motion in both the x- and y-planes expressed as:

$$x'' + \frac{(\gamma_b \beta_b)'}{(\gamma_b \beta_b)} x' + \kappa_x(s)x = -\frac{q}{m\gamma_b^3 \beta_b^2 c^2} \frac{\partial}{\partial x} \phi$$
$$y'' + \frac{(\gamma_b \beta_b)'}{(\gamma_b \beta_b)} y' + \kappa_y(s)y = -\frac{q}{m\gamma_b^3 \beta_b^2 c^2} \frac{\partial}{\partial y} \phi$$

$\kappa_x(s)$ = x-focusing function of lattice

$\kappa_y(s)$ = y-focusing function of lattice

Common focusing functions:

Continuous: $\kappa_x(s) = \kappa_y(s) = k_{\beta 0}^2 = \text{const}$

Quadrupole (Electric or Magnetic):
 $\kappa_x(s) = -\kappa_y(s) = \kappa(s)$

Solenoidal (equations must be interpreted in Larmor Frame: see Appendix **B**):
 $\kappa_x(s) = \kappa_y(s) = \kappa(s)$

Although the equations have the same form, the couplings to the fields are different which leads to different regimes of applicability for the various focusing technologies with their associated technology limits:

Focusing:

Continuous:

$$\kappa_x(s) = \kappa_y(s) = k_{\beta 0}^2 = \text{const}$$

Good qualitative guide (see later material/lecture)

BUT not physically realizable (see **S2B**)

Quadrupole:

$$\kappa_x(s) = -\kappa_y(s) = \begin{cases} \frac{G(s)}{\beta_b c [B\rho]}, & \text{Electric} \\ \frac{G(s)}{c [B\rho]}, & \text{Magnetic} \end{cases} \quad [B\rho] = \frac{m\gamma_b\beta_b c}{q}$$

G is the field gradient which for linear applied fields is:

$$G(s) = \begin{cases} -\frac{\partial E_x^a}{\partial x} = \frac{\partial E_y^a}{\partial y} = \frac{2V_q}{r_p^2}, & \text{Electric} \\ \frac{\partial B_x^a}{\partial y} = \frac{\partial B_y^a}{\partial x} = \frac{B_p}{r_p}, & \text{Magnetic} \end{cases}$$

Solenoid:

$$\kappa_x(s) = \kappa_y(s) = k_L^2(s) = \left[\frac{B_{z0}(s)}{2[B\rho]} \right]^2 = \left[\frac{\omega_c(s)}{2\gamma_b\beta_b c} \right]^2 \quad \omega_c(s) = \frac{qB_{z0}(s)}{m}$$

It is instructive to review the structure of solutions of the transverse particle equations of motion **in the absence of**:

$$\text{Space-charge: } \frac{\partial \phi}{\partial x} \sim \frac{\partial \phi}{\partial y} \sim 0$$

$$\text{Acceleration: } \gamma_b \beta_b \simeq \text{const} \quad \Longrightarrow \quad \frac{(\gamma_b \beta_b)'}{(\gamma_b \beta_b)} \simeq 0$$

In this simple limit, the x and y -equations are of the same **Hill's Equation** form:

$$x'' + \kappa_x(s)x = 0$$

$$y'' + \kappa_y(s)y = 0$$

- ◆ These equations are central to transverse dynamics in conventional accelerator physics (weak space-charge and acceleration)
 - Will study how solutions change with space-charge in later lectures

In many cases beam transport lattices are designed where the applied focusing functions are **periodic**:

$$\kappa_x(s + L_p) = \kappa_x(s)$$

$$\kappa_y(s + L_p) = \kappa_y(s)$$

$$L_p = \text{Lattice Period}$$

Common, simple examples of **periodic lattices**:

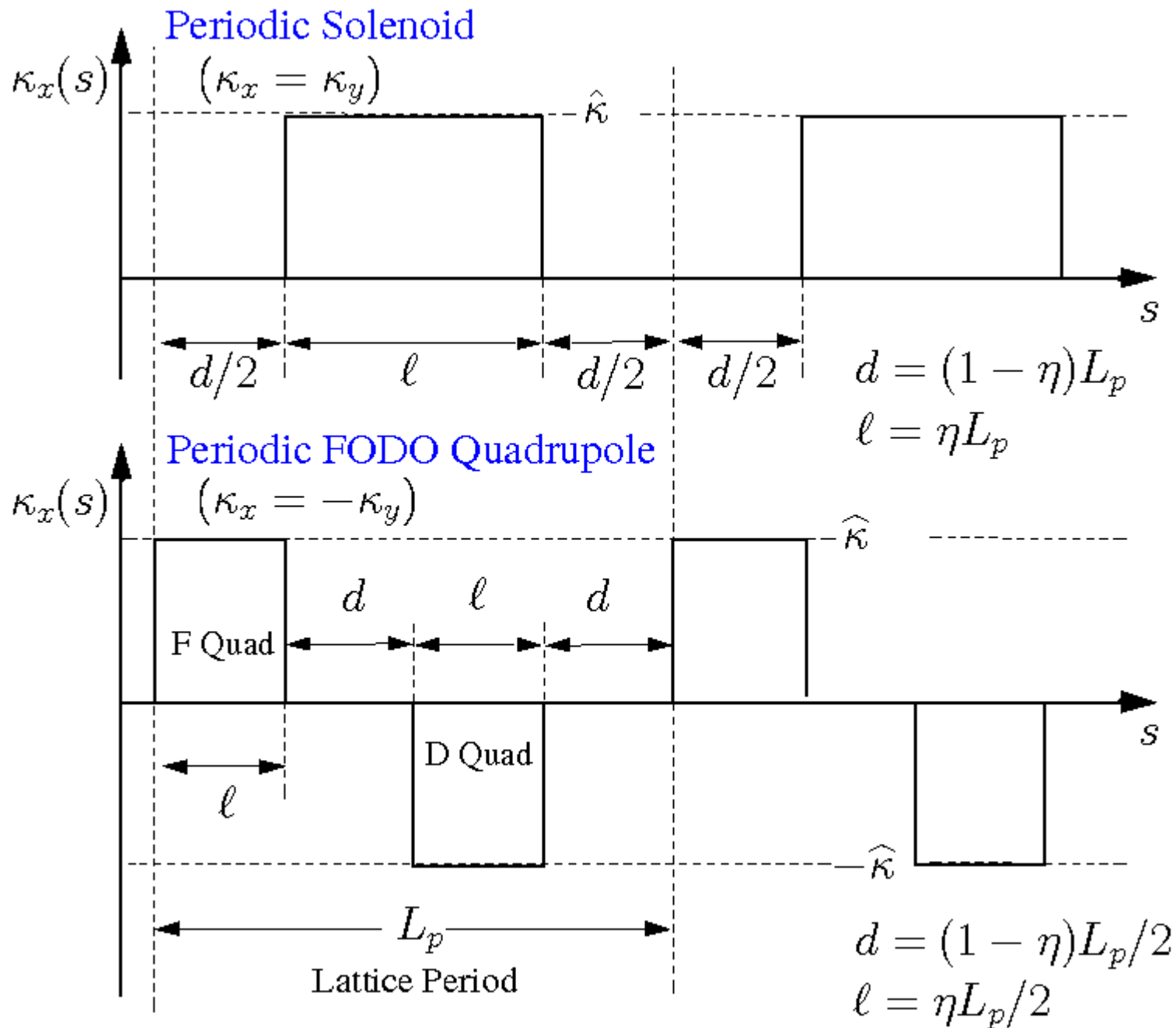

However, the focusing functions need not be periodic:

- ◆ Often take periodic or continuous in this class for simplicity of interpretation

Focusing functions can vary strongly in many common situations:

- ◆ Matching and transition sections
- ◆ Strong acceleration
- ◆ Significantly different elements can occur within periods of lattices in rings
 - “Panofsky” type (wide aperture along one plane) quadrupoles for beam insertion and extraction in a ring

Example of Non-Periodic Focusing Functions: Beam Matching Section

Maintains alternating-gradient structure but not quasi-periodic

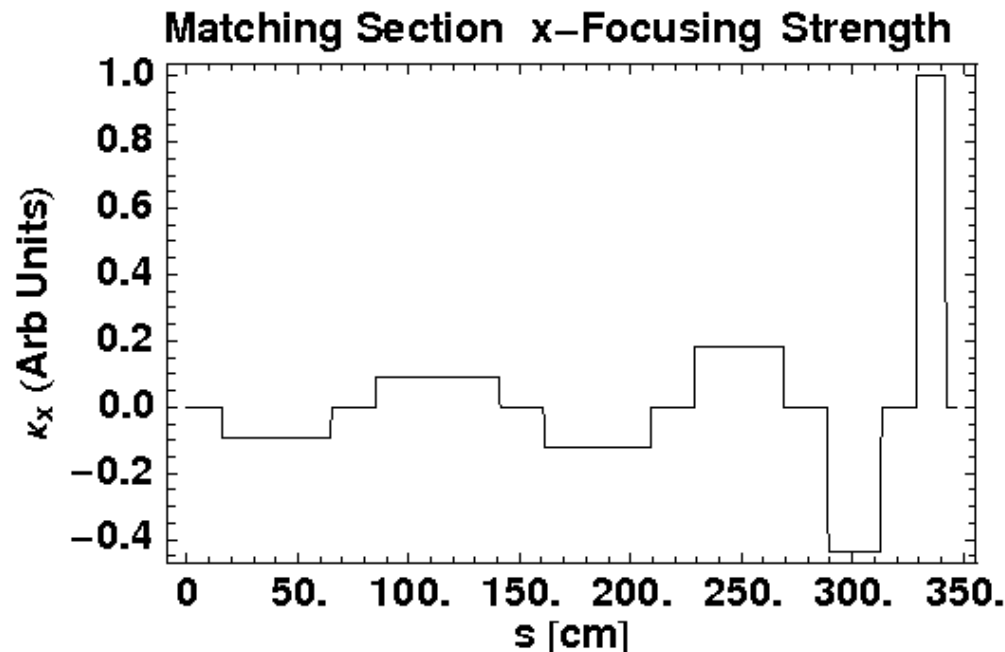

Example corresponds to
High Current Experiment
Matching Section
(hard edge equivalent)
at LBNL (2002)

Equations presented in this section apply to a single particle moving in a beam under the action of linear applied focusing forces. In the remaining sections, we will (mostly) neglect space-charge ($\phi \rightarrow 0$) as is conventional in the standard theory of low-intensity accelerators.

- ◆ What we learn from treatment will later aid analysis of space-charge effects
 - Appropriate variable substitutions will be made to apply results
- ◆ Important to understand basic applied field dynamics since space-charge complicates
 - Results in plasma-like collective response

/// **Example:** We will see in **Transverse Centroid and Envelope Descriptions of Beam Evolution** that the linear particle equations of motion can be applied to analyze the evolution of a beam when image charges are neglected

$$x \rightarrow x_c \equiv \langle x \rangle_{\perp} \quad x - \text{centroid}$$

$$y \rightarrow y_c \equiv \langle y \rangle_{\perp} \quad y - \text{centroid}$$

///

Appendix A: Quadrupole Skew Coupling

Consider a quadrupole **actively rotated** through an angle ψ about the z-axis:

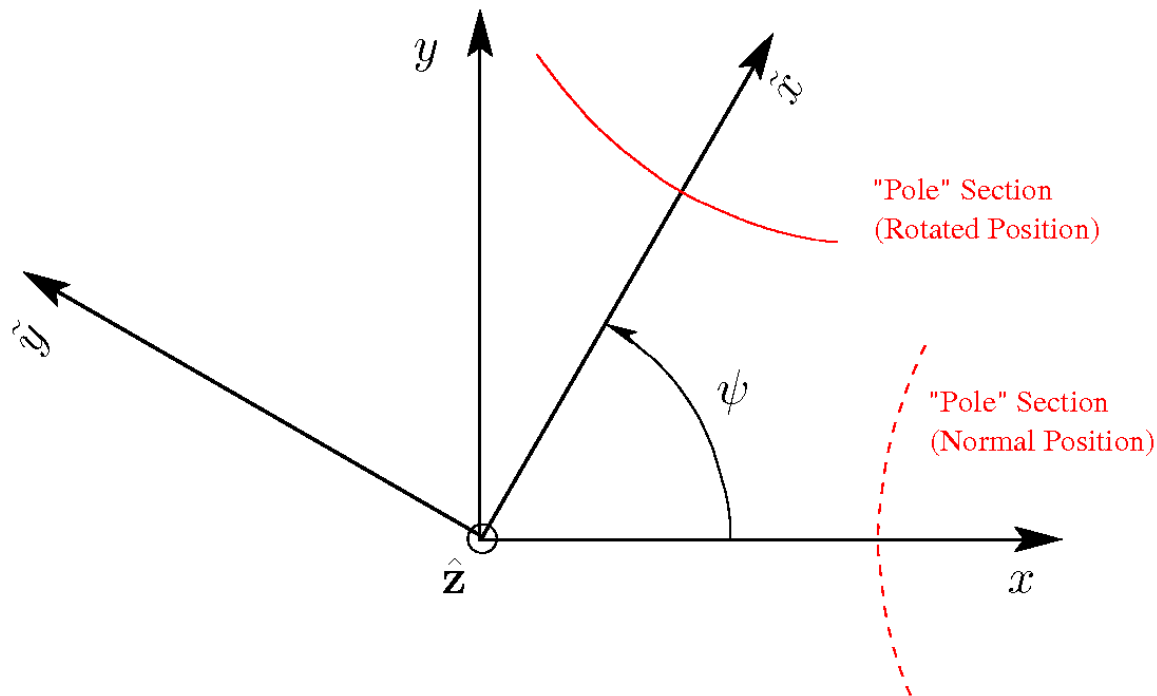

Transforms

$$\tilde{x} = x \cos \psi + y \sin \psi$$

$$\tilde{y} = -x \sin \psi + y \cos \psi$$

$$x = \tilde{x} \cos \psi - \tilde{y} \sin \psi$$

$$y = \tilde{x} \sin \psi + \tilde{y} \cos \psi$$

Normal Orientation Fields

Electric

$$E_x^a = -Gx$$

$$E_y^a = Gy$$

$$G = G(s)$$

= Field Gradient (Electric or Magnetic)

Magnetic

$$B_x^a = Gy$$

$$B_y^a = Gx$$

Note: units of G different in electric and magnetic cases

Rotated Fields

Electric

$$\begin{aligned} E_x^a &= E_{\tilde{x}}^a \cos \psi - E_{\tilde{y}}^a \sin \psi & E_{\tilde{x}}^a &= -G\tilde{x} = -G(x \cos \psi + y \sin \psi) \\ E_y^a &= E_{\tilde{x}}^a \sin \psi + E_{\tilde{y}}^a \cos \psi & E_{\tilde{y}}^a &= G\tilde{y} = G(-x \sin \psi + y \cos \psi) \end{aligned}$$

Combine equations, collect terms, and apply trigonometric identities to obtain:

$$\begin{aligned} E_x^a &= -G \cos(2\psi)x - G \sin(2\psi)y & 2 \sin \psi \cos \psi &= \sin(2\psi) \\ E_y^a &= -G \sin(2\psi)x + G \cos(2\psi)y & \cos^2 \psi - \sin^2 \psi &= \cos(2\psi) \end{aligned}$$

Magnetic

$$\begin{aligned} B_x^a &= B_{\tilde{x}}^a \cos \psi - B_{\tilde{y}}^a \sin \psi & B_{\tilde{x}}^a &= G\tilde{y} = G(-x \sin \psi + y \cos \psi) \\ B_y^a &= B_{\tilde{x}}^a \sin \psi + B_{\tilde{y}}^a \cos \psi & B_{\tilde{y}}^a &= G\tilde{x} = G(x \cos \psi + y \sin \psi) \end{aligned}$$

Combine equations, collect terms, and apply trigonometric identities to obtain:

$$\begin{aligned} B_x^a &= -G \sin(2\psi)x + G \cos(2\psi)y \\ B_y^a &= G \cos(2\psi)x + G \sin(2\psi)y \end{aligned}$$

For *both* **electric** and **magnetic** focusing quadrupoles, these field component projections can be inserted in the linear field Eqns of motion to obtain:

Skew Coupled Quadrupole Equations of Motion

$$x'' + \frac{(\gamma_b \beta_b)'}{(\gamma_b \beta_b)} x' + \kappa \cos(2\psi)x + \kappa \sin(2\psi)y = -\frac{q}{m\gamma_b^3 \beta_b^2 c^2} \frac{\partial \phi}{\partial x}$$

$$y'' + \frac{(\gamma_b \beta_b)'}{(\gamma_b \beta_b)} y' - \kappa \cos(2\psi)y + \kappa \sin(2\psi)x = -\frac{q}{m\gamma_b^3 \beta_b^2 c^2} \frac{\partial \phi}{\partial y}$$

$$\kappa = \begin{cases} \frac{G}{\beta_b c [B\rho]}, & \text{Electric Focusing} \\ \frac{G}{[B\rho]}, & \text{Magnetic Focusing} \end{cases}$$

System is **skew coupled**:

- ◆ x-equation depends on y, y' and y-equation on x, x' for $\psi \neq n\pi/2$ (n integer)

Skew-coupling considerably complicates dynamics

- ◆ Unless otherwise specified, we consider only quadrupoles with “normal” orientation with $\psi = n\pi/2$
- ◆ Skew coupling errors or intentional skew couplings can be important
 - Leads to transfer of oscillations energy between x and y -planes
 - Invariants much more complicated to construct/interpret

The skew coupled equations of motion can be alternatively derived by actively rotating the quadrupole equation of motion in the form:

$$x'' + \frac{(\gamma_b \beta_b)'}{(\gamma_b \beta_b)} x' + \kappa(s)x = -\frac{q}{m\gamma_b^3 \beta_b^2 c^2} \frac{\partial \phi}{\partial x}$$
$$y'' + \frac{(\gamma_b \beta_b)'}{(\gamma_b \beta_b)} y' - \kappa(s)y = -\frac{q}{m\gamma_b^3 \beta_b^2 c^2} \frac{\partial \phi}{\partial y}$$

- ◆ Steps are then identical whether quadrupoles are electric *or* magnetic

Appendix D: Axisymmetric Applied Magnetic or Electric Field Expansion

Static, rationally symmetric static applied fields \mathbf{E}^a , \mathbf{B}^a satisfy the vacuum Maxwell equations in the beam aperture:

$$\nabla \cdot \mathbf{E}^a = 0 \quad \nabla \times \mathbf{E}^a = 0 \quad \nabla \cdot \mathbf{B}^a = 0 \quad \nabla \times \mathbf{B}^a = 0$$

This implies we can take for some electric potential ϕ^e and magnetic potential ϕ^m :

$$\mathbf{E}^a = -\nabla\phi^e \quad \mathbf{B}^a = -\nabla\phi^m$$

which in the vacuum aperture satisfies the Laplace equations:

$$\nabla^2\phi^e = 0 \quad \nabla^2\phi^m = 0$$

We will analyze the magnetic case and the electric case is analogous. In axisymmetric ($\partial/\partial\theta = 0$) geometry we express Laplace's equation as:

$$\nabla^2\phi^m(r, z) = \frac{1}{r} \frac{\partial}{\partial r} \left(r \frac{\partial\phi^m}{\partial r} \right) + \frac{\partial^2\phi^m}{\partial z^2} = 0$$

$\phi^m(r, z)$ can be expanded as (odd terms in r would imply nonzero $B_r = -\frac{\partial\phi^m}{\partial r}$ at $r = 0$):

$$\phi^m(r, z) = \sum_{\nu=0}^{\infty} f_{2\nu}(z)r^{2\nu} = f_0 + f_2r^2 + f_4r^4 + \dots$$

where $f_0 = \phi^m(r = 0, z)$ is the on-axis potential

Plugging ϕ^m into Laplace's equation yields the recursion relation for $f_{2\nu}$

$$(2\nu + 2)^2 f_{2\nu+2} + f_{2\nu}'' = 0$$

Iteration then shows that

$$\phi^m(r, z) = \sum_{\nu=0}^{\infty} \frac{(-1)^\nu}{(\nu!)^2} \frac{\partial^{2\nu} f(0, z)}{\partial z^{2\nu}} \left(\frac{r}{2}\right)^{2\nu}$$

Using $B_z^a(r=0, z) \equiv B_{z0}(z) = -\frac{\partial\phi_m(0, z)}{\partial z}$ and differentiating yields:

$$B_r^a(r, z) = -\frac{\partial\phi_m}{\partial r} = \sum_{\nu=1}^{\infty} \frac{(-1)^\nu}{(\nu!)(\nu-1)!} \frac{\partial^{2\nu-1} B_{z0}(z)}{\partial z^{2\nu-1}} \left(\frac{r}{2}\right)^{2\nu-1}$$

$$B_z^a(r, z) = -\frac{\partial\phi_m}{\partial z} = \sum_{\nu=0}^{\infty} \frac{(-1)^\nu}{(\nu!)^2} \frac{\partial^{2\nu} B_{z0}(z)}{\partial z^{2\nu}} \left(\frac{r}{2}\right)^{2\nu}$$

- ◆ Electric case immediately analogous and can arise in electrostatic Einzel lens focusing systems often employed near injectors
- ◆ Electric case can also be applied to RF and induction gap structures in the quasistatic (long RF wavelength relative to gap) limit.

D2

Appendix E: Thin Lens Equivalence for Thick Lenses

In the thin lens model for an orbit described by Hill's equation:

$$x''(s) + \kappa_x(s)x(s) = 0$$

the applied focusing function $\kappa_x(s)$ is replaced by a “thin-lens” kick described by:

$$\kappa_x(s) = \frac{1}{f} \delta(s - s_0) \quad \begin{array}{l} s_0 = \text{Optic Location} = \text{const} \\ f = \text{focal length} = \text{const} \end{array}$$

The transfer matrix to describe the action of the thin lens is found by integrating the Hill's equation to be:

$$\begin{bmatrix} x \\ x' \end{bmatrix}_{s=s_0^+} = \begin{bmatrix} 1 & 0 \\ -1/f & 1 \end{bmatrix} \cdot \begin{bmatrix} x \\ x' \end{bmatrix}_{s=s_0^-} \equiv \mathbf{M}_{\text{kick}} \begin{bmatrix} x \\ x' \end{bmatrix}_{s=s_0^-}$$

Graphical Interpretation:

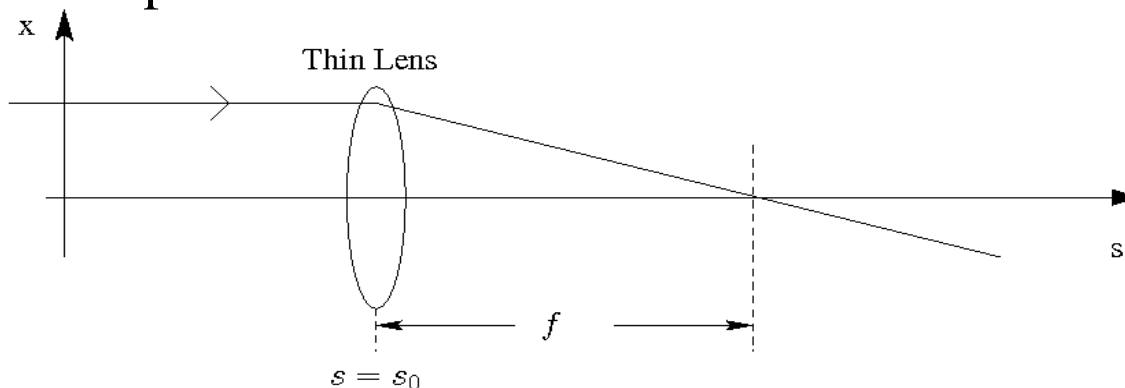

For a free drift, Hill's equation is:

$$x''(s) = 0$$

with a corresponding transfer matrix solution:

$$\begin{bmatrix} x \\ x' \end{bmatrix}_s = \begin{bmatrix} 1 & (s - s_i) \\ 0 & 1 \end{bmatrix} \cdot \begin{bmatrix} x \\ x' \end{bmatrix}_{s_i} \equiv \mathbf{M}_{\text{drift}} \begin{bmatrix} x \\ x' \end{bmatrix}_{s_i}$$

We will show that the thin lens and two drifts can *exactly* replace

Case 1) Piecewise constant focusing lens: $\kappa_x(s) = \kappa = \text{const} > 0$

Case 2) Piecewise constant defocusing lens: $\kappa_x(s) = -\kappa = \text{const} < 0$

Case 3) Arbitrary linear lens represented by: $\kappa_x(s)$

This can be helpful since the thin lens + drift model is simple both to carry out algebra and conceptually understand.

Case 1) The piecewise constant focusing transfer matrix \mathbf{M}_x for $\kappa_x = \kappa > 0$ can be resolved as:

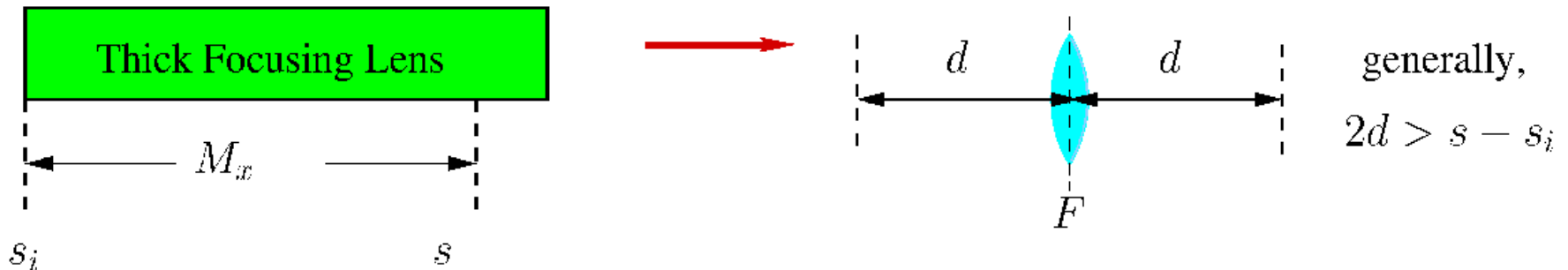

$$\begin{aligned} \mathbf{M}_{\mathbf{x}}(s|s_i) &= \begin{bmatrix} C(s) & S(s)/\sqrt{\kappa} \\ -\sqrt{\kappa}S(s) & C(s) \end{bmatrix} \\ &= \begin{bmatrix} 1 & d(s) \\ 0 & 1 \end{bmatrix} \cdot \begin{bmatrix} 1 & 0 \\ -1/f(s) & 1 \end{bmatrix} \cdot \begin{bmatrix} 1 & d(s) \\ 0 & 1 \end{bmatrix} \\ &\equiv \mathbf{M}_{\text{drift}} \cdot \mathbf{M}_{\text{kick}} \cdot \mathbf{M}_{\text{drift}} \end{aligned}$$

where

$$\begin{aligned} C(s) &= \cos[\sqrt{\kappa}(s - s_i)] & d(s) &= \tan[\sqrt{\kappa}(s - s_i)/2]/\sqrt{\kappa} \\ S(s) &= \sin[\sqrt{\kappa}(s - s_i)] & 1/f(s) &= \sqrt{\kappa}S(s) \end{aligned}$$

This resolves the thick focusing lens into a thin-lens kick \mathbf{M}_{kick} between two equal length drifts $\mathbf{M}_{\text{drift}}$ upstream and downstream of the kick

- ◆ Result specifies *exact* thin-lens equivalent focusing element
- ◆ Can also be applied to continuous focusing (in interval) and solenoid focusing (in Larmor frame, see [S2E](#) and [Appendix C](#)) by substituting appropriately for κ
- ◆ Must adjust element length consistently with composite replacement

E3

Case 2) The piecewise constant de-focusing transfer matrix \mathbf{M}_x for $\kappa_x = -\kappa < 0$ can be resolved as:

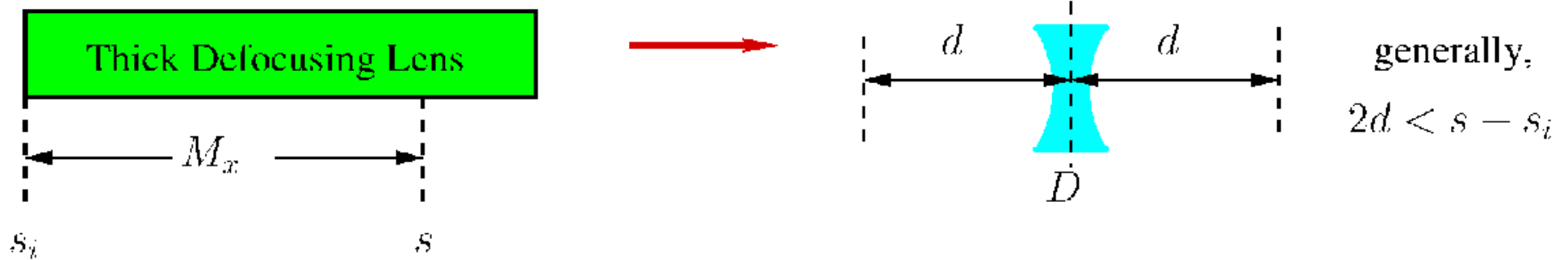

$$\begin{aligned}
 \mathbf{M}_x(s|s_i) &= \begin{bmatrix} \text{Ch}(s) & \text{Sh}(s)/\sqrt{\kappa} \\ \sqrt{\kappa}\text{Sh}(s) & \text{Ch}(s) \end{bmatrix} \\
 &= \begin{bmatrix} 1 & d(s) \\ 0 & 1 \end{bmatrix} \cdot \begin{bmatrix} 1 & 0 \\ 1/f(s) & 1 \end{bmatrix} \cdot \begin{bmatrix} 1 & d(s) \\ 0 & 1 \end{bmatrix} \\
 &\equiv \mathbf{M}_{\text{drift}} \cdot \mathbf{M}_{\text{kick}} \cdot \mathbf{M}_{\text{drift}}
 \end{aligned}$$

where

$$\text{Ch}(s) = \cosh[\sqrt{\kappa}(s - s_i)] \quad d(s) = \tanh[\sqrt{\kappa}(s - s_i)/2]/\sqrt{\kappa}$$

$$\text{Sh}(s) = \sinh[\sqrt{\kappa}(s - s_i)] \quad 1/f(s) = \sqrt{\kappa}\text{Sh}(s)$$

- ◆ Result is *exact* thin-lens equivalent defocusing element
- ◆ Can be applied together with thin lens focus replacement to more simply derive phase-advance formulas etc for AG focusing lattices
- ◆ Must adjust element length consistently with composite replacement

Case 3) General element replacement with an equivalent thin lens

Consider a general transport matrix:

$$\mathbf{M} = \begin{bmatrix} M_{11} & M_{12} \\ M_{21} & M_{22} \end{bmatrix} \quad \det \mathbf{M} = M_{11}M_{22} - M_{12}M_{21} = 1$$

◆ Always true for linear optics, see Sec **S5**

A transfer matrix of a drift of length d_1 followed by a thin lens of strength f , followed by a drift of length d_2 gives:

$$\mathbf{M}_{\text{drift2+thin+drift1}} = \begin{bmatrix} 1 & d_2 \\ 0 & 1 \end{bmatrix} \cdot \begin{bmatrix} 1 & 0 \\ -1/f & 1 \end{bmatrix} \cdot \begin{bmatrix} 1 & d_1 \\ 0 & 1 \end{bmatrix}$$

$$\text{Setting } \mathbf{M} = \mathbf{M}_{\text{drift2+thin+drift1}} = \begin{bmatrix} 1 - d_2/f & d_1 + d_2 - d_1d_2/f \\ -1/f & 1 - d_1/f \end{bmatrix}$$

$$d_1 = (M_{22} - 1)/M_{21}$$

$$d_2 = (M_{11} - 1)/M_{21}$$

$$-1/f = M_{21}$$

◆ M_{12} implicitly involved due to unit determinant constraint

Discussions of this, and similar results can be found in older optics books such as: Banford, *The Transport of Charged Particle Beams*, 1965. **E5**

Comments:

- ◆ Shows that *any* linear optic (thick or thin) can be resolved into an equivalent thin lens kick + drifts
 - Use requires element effective length in drift + thin-lens-kick + drift to be adjusted consistently
 - - Care must be taken to interpret lattice period with potentially different axial extent focusing elements correctly
- ◆ Orbits in thin-lens replacements may differ a little in max excursions etc, but this shows simple and rapid design estimates can be made using thin lens models if proper equivalences are employed
 - Analysis of thin lens + drifts can simplify interpretation and algebraic steps
- ◆ Construct applies to solenoidal focusing also if the orbit is analyzed in the Larmor frame where the decoupled orbit can be analyzed with Hill's equation, but it does *not* apply in the laboratory frame
 - Piecewise constant (hard-edge) solenoid in lab frame can be resolved into a rotation + thin-lens kick structure though (see [Appendix C](#))

S4: Transverse Particle Equations of Motion with Nonlinear Applied Fields

S4A: Overview

In **S1** we showed that the particle equations of motion can be expressed as:

$$\mathbf{x}_{\perp}'' + \frac{(\gamma_b \beta_b)'}{(\gamma_b \beta_b)} \mathbf{x}_{\perp}' = \frac{q}{m \gamma_b \beta_b^2 c^2} \mathbf{E}_{\perp}^a + \frac{q}{m \gamma_b \beta_b c} \hat{\mathbf{z}} \times \mathbf{B}_{\perp}^a + \frac{q B_z^a}{m \gamma_b \beta_b c} \mathbf{x}_{\perp}' \times \hat{\mathbf{z}} - \frac{q}{\gamma_b^3 \beta_b^2 c^2} \frac{\partial}{\partial \mathbf{x}_{\perp}} \phi$$

When momentum spread is neglected and results are interpreted in a Cartesian coordinate system (no bends). In **S2**, we showed that these equations can be further reduced when the applied focusing fields are **linear** to:

$$x'' + \frac{(\gamma_b \beta_b)'}{(\gamma_b \beta_b)} x' + \kappa_x(s)x = -\frac{q}{m \gamma_b^3 \beta_b^2 c^2} \frac{\partial}{\partial x} \phi$$

$$y'' + \frac{(\gamma_b \beta_b)'}{(\gamma_b \beta_b)} y' + \kappa_y(s)y = -\frac{q}{m \gamma_b^3 \beta_b^2 c^2} \frac{\partial}{\partial y} \phi$$

where

$\kappa_x(s)$ = x -focusing function of lattice

$\kappa_y(s)$ = y -focusing function of lattice

describe the linear applied focusing forces and the equations are implicitly analyzed in the rotating Larmor frame when $B_z^a \neq 0$.

Lattice designs attempt to **minimize nonlinear applied fields**. However, the 3D Maxwell equations show that there will *always* be some finite nonlinear applied fields for an applied focusing element with finite extent. Applied field nonlinearities also result from:

- ◆ Design idealizations
- ◆ Fabrication and material errors

The largest source of nonlinear terms will depend on the case analyzed.

Nonlinear applied fields must be added back in the idealized model when it is appropriate to analyze their effects

- ◆ Common problem to address when carrying out large-scale numerical simulations to design/analyze systems

There are two basic approaches to carry this out:

Approach 1: Explicit 3D Formulation

Approach 2: Perturbations About Linear Applied Field Model

We will now discuss each of these in turn

S4B: Approach 1: Explicit 3D Formulation

This is the simplest. Just employ the full 3D equations of motion expressed in terms of the applied field components \mathbf{E}^a , \mathbf{B}^a and avoid using the focusing functions κ_x , κ_y

Comments:

- ♦ Most easy to apply in computer simulations where many effects are simultaneously included
 - Simplifies comparison to experiments when many details matter for high level agreement
- ♦ Simplifies simultaneous inclusion of transverse and longitudinal effects
 - Accelerating field E_z^a can be included to calculate changes in β_b , γ_b
 - Transverse and longitudinal dynamics cannot be fully decoupled in high level modeling – especially try when acceleration is strong in systems like injectors
- ♦ Can be applied with time based equations of motion (see: S1)
 - Helps avoid unit confusion and continuously adjusting complicated equations of motion to identify the axial coordinate s appropriately

S4C: Approach 2: Perturbations About Linear Applied Field Model

Exploit the linearity of the Maxwell equations to take:

$$\begin{aligned}\mathbf{E}_\perp^a &= \mathbf{E}_\perp^a|_L + \delta\mathbf{E}_\perp^a \\ \mathbf{B}^a &= \mathbf{B}^a|_L + \delta\mathbf{B}^a\end{aligned}$$

where

$\mathbf{E}_\perp^a|_L, \mathbf{B}^a|_L$ are the linear field components incorporated in κ_x, κ_y

to express the equations of motion as:

$$\begin{aligned}x'' + \frac{(\gamma_b\beta_b)'}{(\gamma_b\beta_b)}x' + \kappa_x x &= \frac{q}{m\gamma_b\beta_b^2c^2}\delta E_x^a - \frac{q}{m\gamma_b\beta_b c}\delta B_y^a + \frac{q}{m\gamma_b\beta_b c}\delta B_z^a y' \\ &\quad - \frac{q}{m\gamma_b^3\beta_b^2c^2}\frac{\partial\phi}{\partial x} \\ y'' + \frac{(\gamma_b\beta_b)'}{(\gamma_b\beta_b)}y' + \kappa_y y &= \frac{q}{m\gamma_b\beta_b^2c^2}\delta E_y^a + \frac{q}{m\gamma_b\beta_b c}\delta B_x^a - \frac{q}{m\gamma_b\beta_b c}\delta B_z^a x' \\ &\quad - \frac{q}{m\gamma_b^3\beta_b^2c^2}\frac{\partial\phi}{\partial y}\end{aligned}$$

This formulation can be most useful to understand the effect of deviations from the usual linear model where intuition is developed

Comments:

- ◆ Best suited to non-solenoidal focusing
 - Simplified Larmor frame analysis for solenoidal focusing is only valid for axisymmetric potentials $\phi = \phi(r)$ which may not hold in the presence of non-ideal perturbations.
 - Applied field perturbations $\delta\mathbf{E}_\perp^a$, $\delta\mathbf{B}^a$ would also need to be projected into the Larmor frame
- ◆ Applied field perturbations $\delta\mathbf{E}_\perp^a$, $\delta\mathbf{B}^a$ will not necessarily satisfy the 3D Maxwell Equations by themselves
 - Follows because the linear field components $\mathbf{E}_\perp^a|_L$, $\mathbf{B}^a|_L$ will not, in general, satisfy the 3D Maxwell equations by themselves

Corrections and suggestions for improvements welcome!

These notes will be corrected and expanded for reference and for use in future editions of US Particle Accelerator School (USPAS) and Michigan State University (MSU) courses. Contact:

Prof. Steven M. Lund
Facility for Rare Isotope Beams
Michigan State University
640 South Shaw Lane
East Lansing, MI 48824

lund@frib.msu.edu

(517) 908 – 7291 office

(510) 459 - 4045 mobile

Please provide corrections with respect to the present archived version at:

https://people.nsl.msu.edu/~lund/uspas/ap_2018/

Redistributions of class material welcome. Please do not remove author credits.