

The LHC's Next Frontier: Searching for Pairs of Higgs Bosons to Understand the Standard Model and Beyond

Fermilab Wine and Cheese

Maximilian Swiatlowski

TRIUMF



The LHC Context

What Do We
Look For?

The Next Frontier:
Higgs Pairs

Outlook

The Standard Model

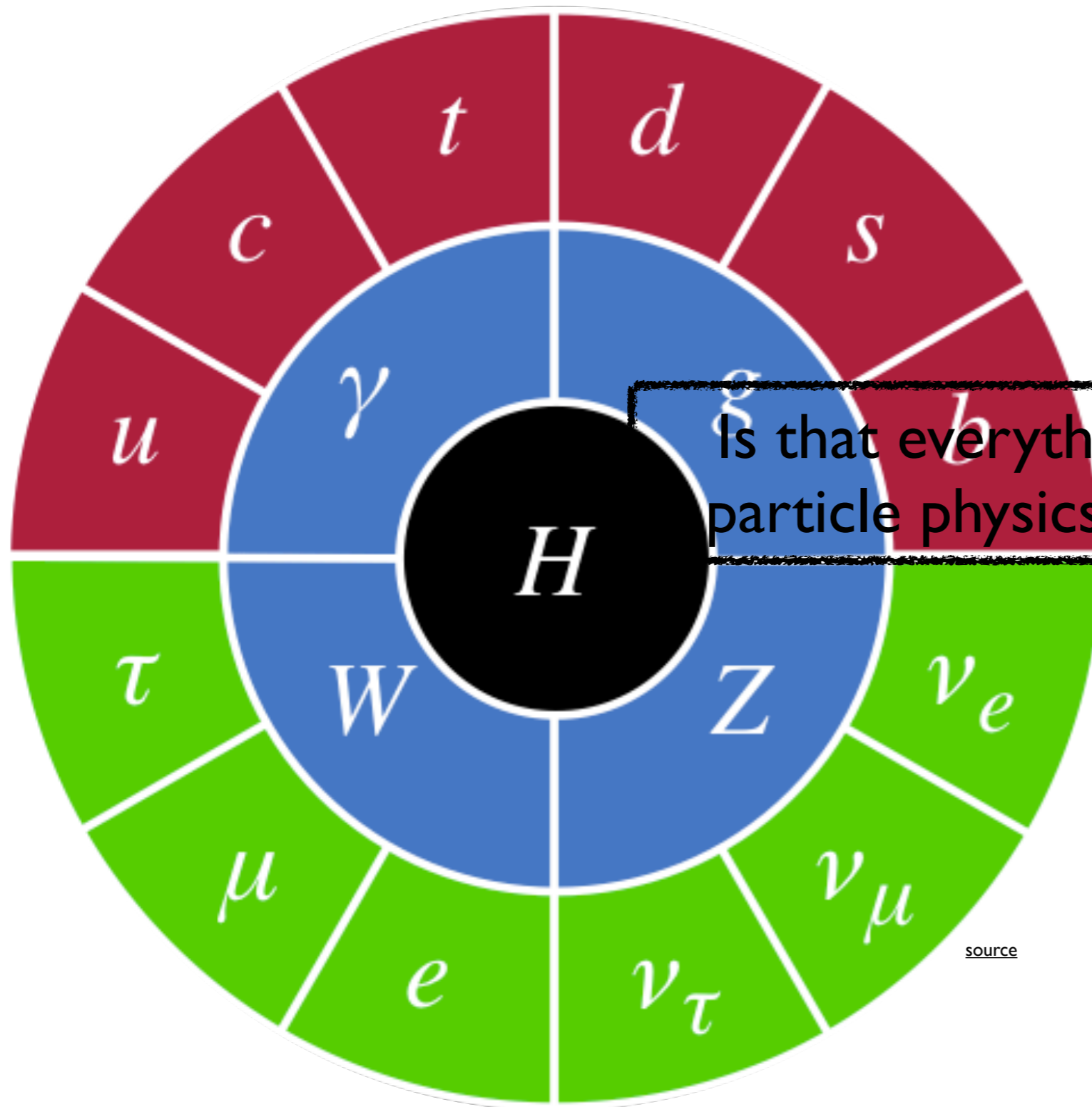

Is that everything?
particle physics over?

Quarks

- Matter particles
- Electroweak and strong interactions

Leptons

- Matter particles
- Electroweak interactions

Gauge Bosons

- Force carriers
- Mediate electroweak and strong interactions

Higgs Boson

- Provides electroweak symmetry breaking

We can observe an incredible amount of the universe, from the smallest scales, to the largest scales, and one thing is missing...

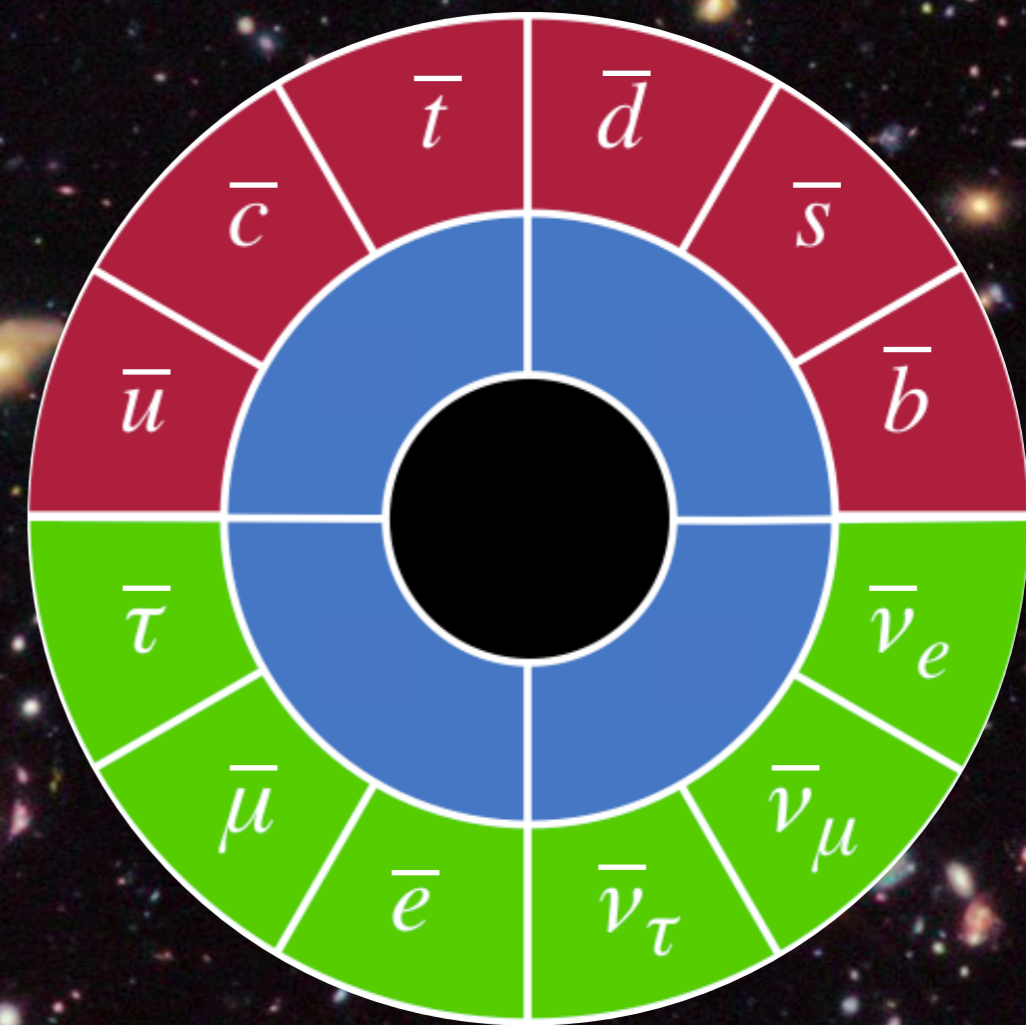
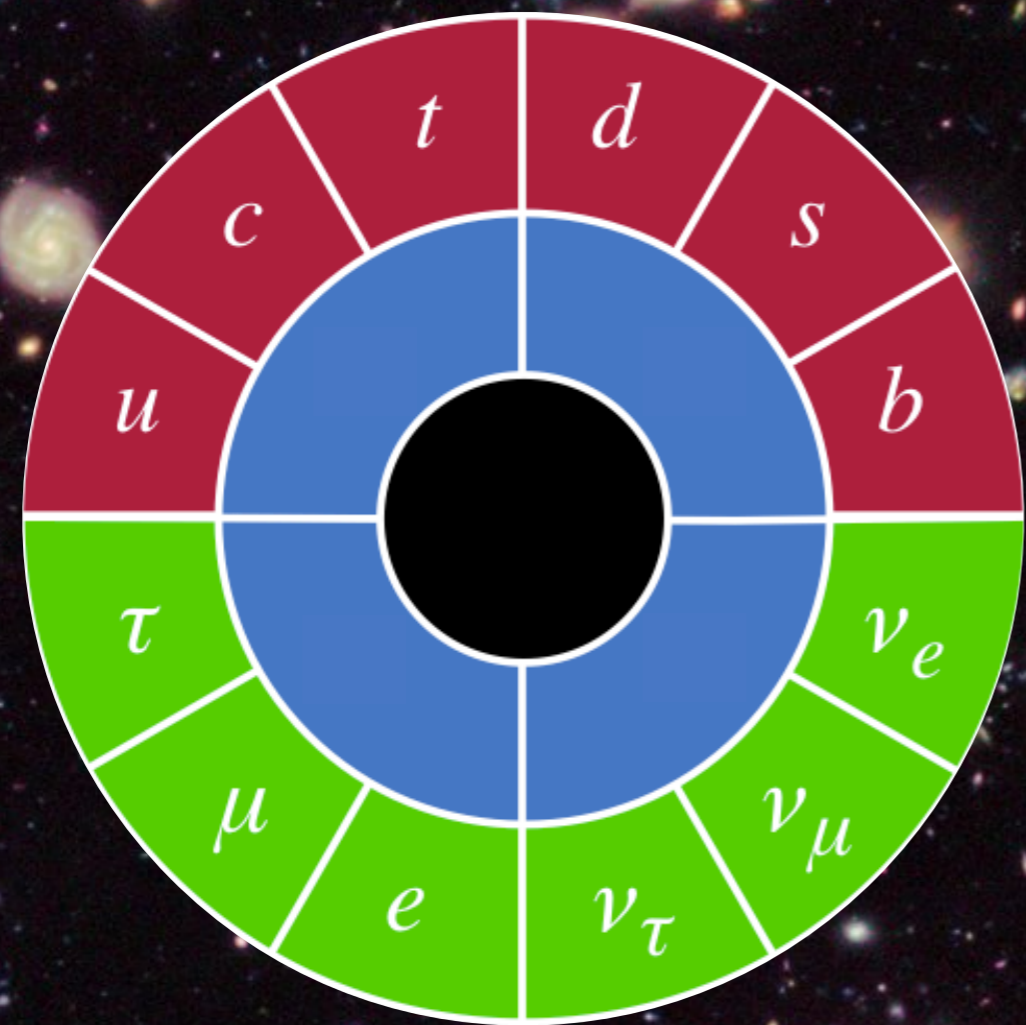

Everything we see is **matter**

Where is the **anti-matter**?

The Big Bang should have produced them equally!

The SM cannot explain anti-matter's disappearance

Afterglow Light Pattern
375,000 yrs.

Dark Ages

Development of
Galaxies, Planets, etc.

Inflation

We all know the story of the Big Bang...

But what about the future of the universe?

Is our universe stable? What can we test?
New physics can affect these conclusions!

Quantum
Fluctuations

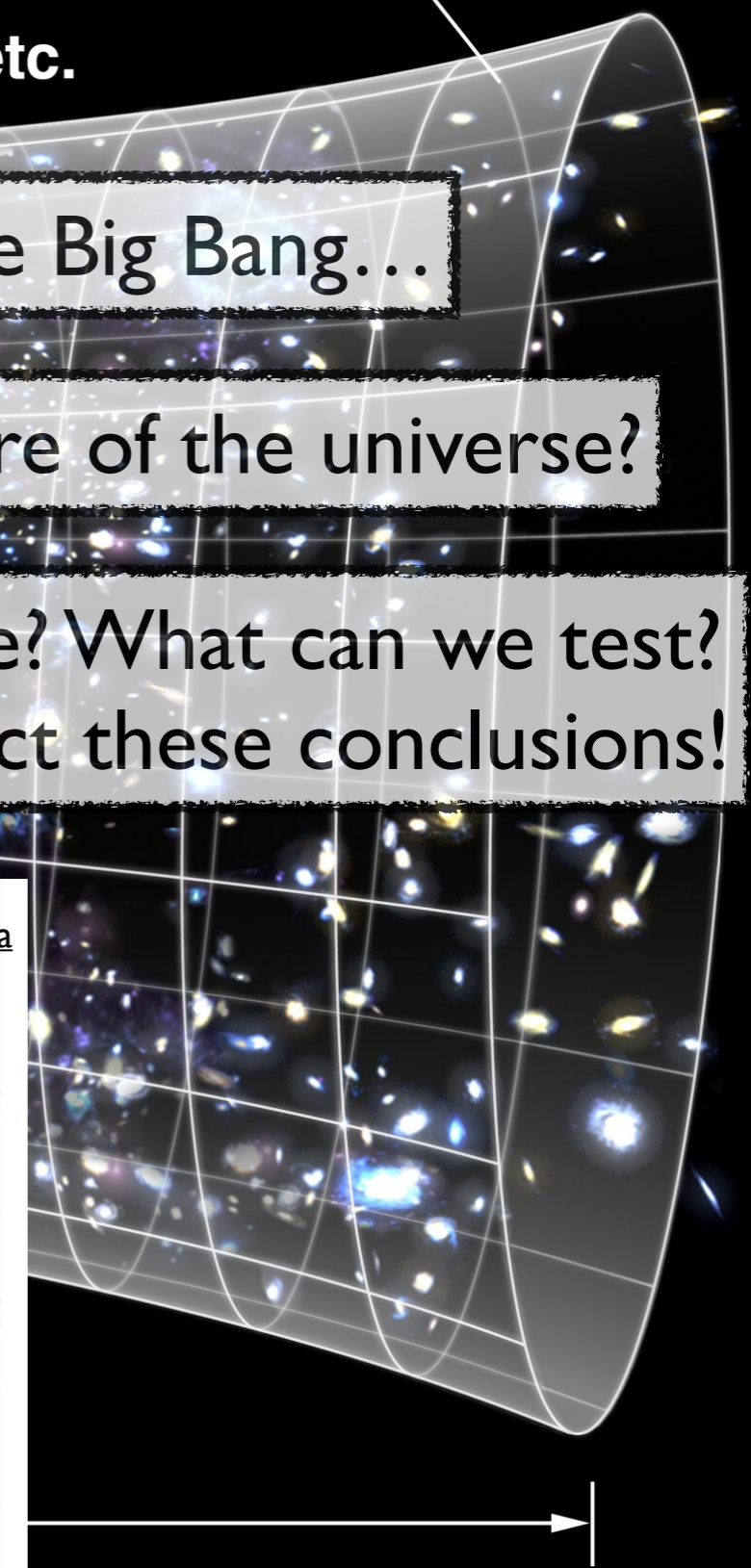
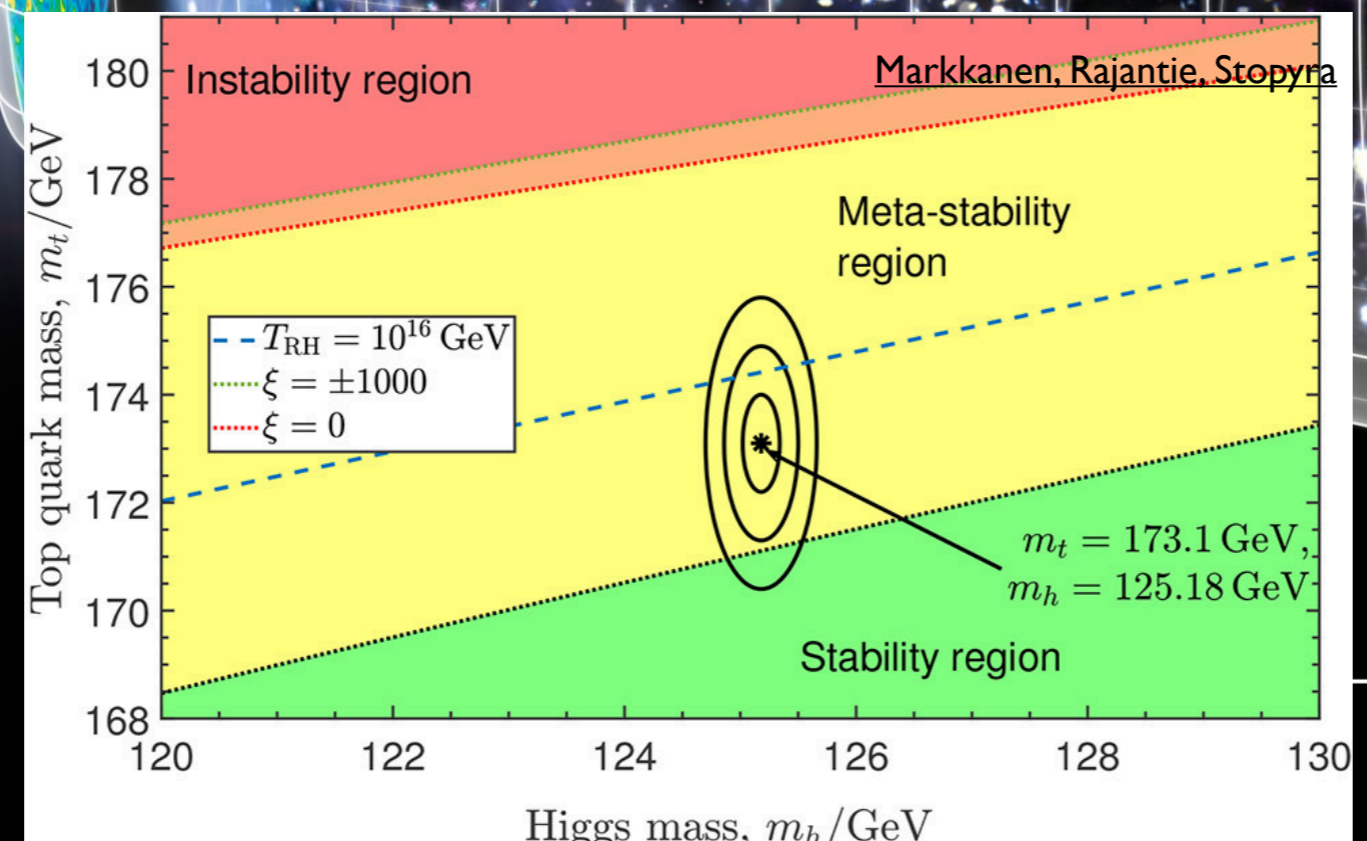

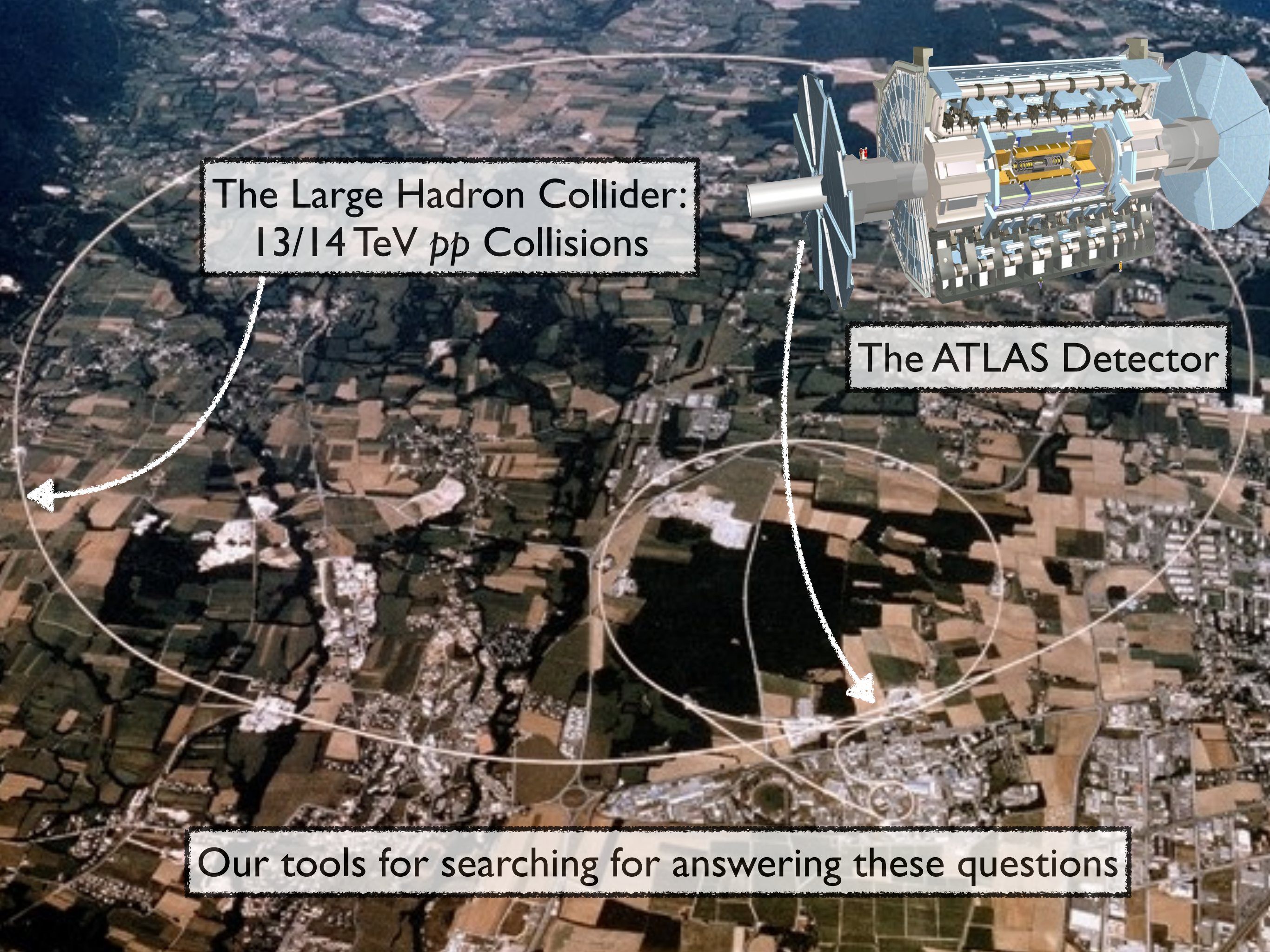

The Large Hadron Collider:
13/14 TeV pp Collisions

The ATLAS Detector

Our tools for searching for answering these questions

What Has the LHC Taught Us?

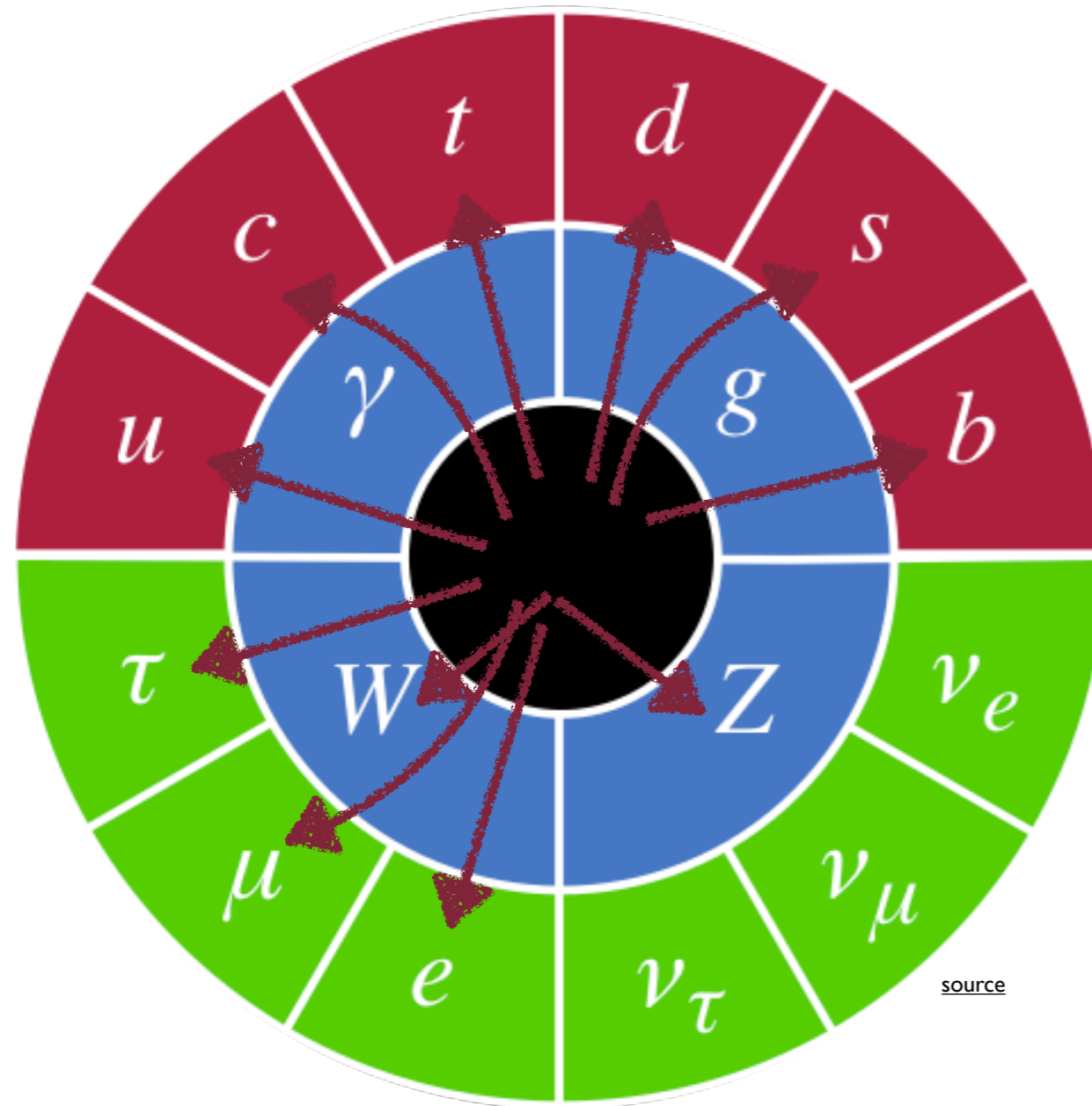

The Higgs is the center of the Standard Model

The process of Electroweak Symmetry Breaking creates massive gauge bosons

The Higgs field gives masses to all the fermions

The SM doesn't make sense without the Higgs

Can the Higgs also contain hints towards BSM?

The LHC Context

What Do We
Look For?

The Next Frontier:
Higgs Pairs

Outlook

What We Know

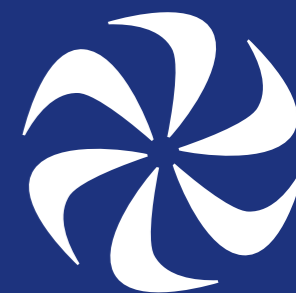

Interaction strength

Ratio to SM

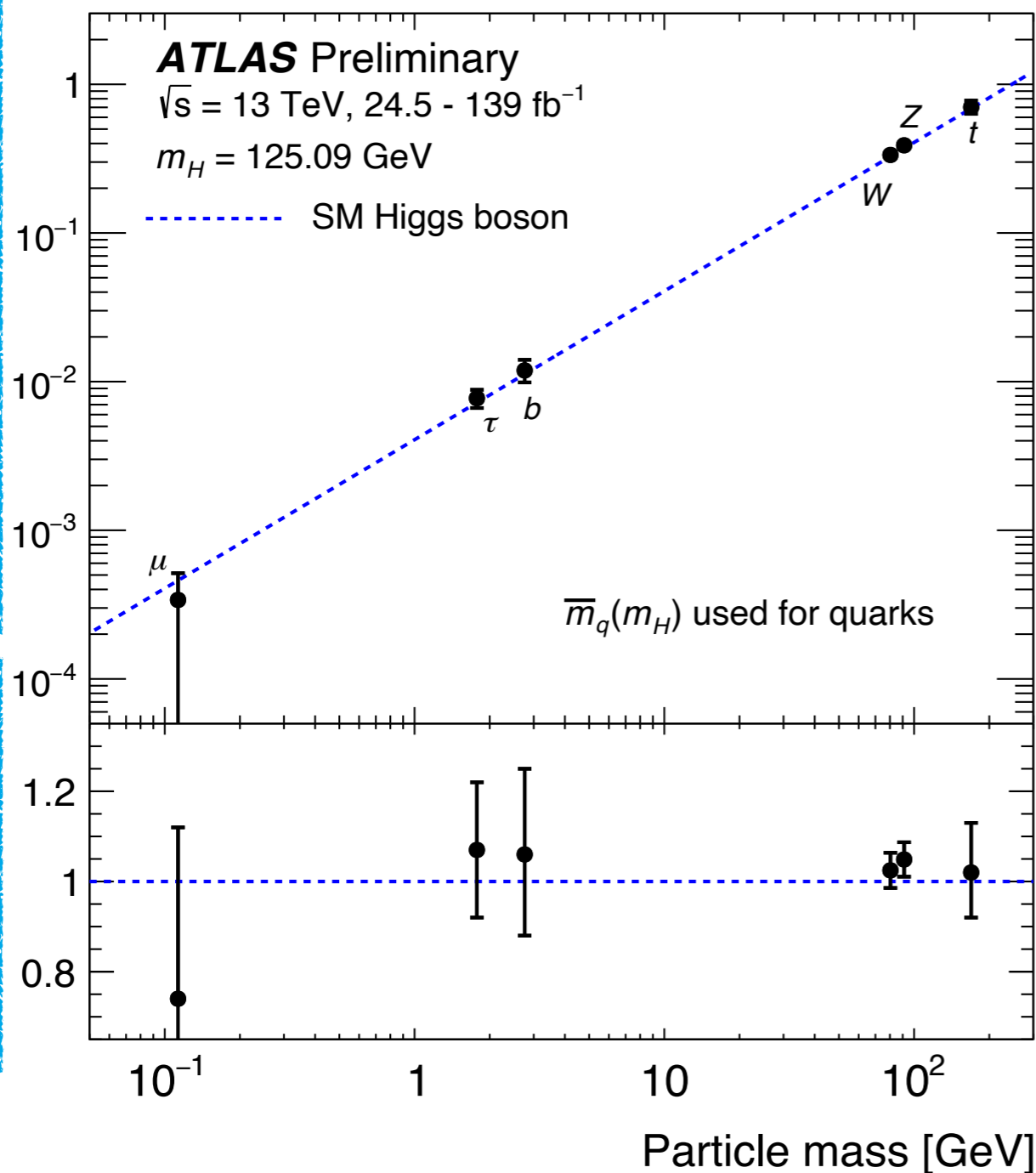

How does our new particle interact with other particles?

So far: following our expectations from the SM almost completely

We are moving into the precision era, reducing errors

But is there anything we don't know yet about the Higgs boson?

The Lagrangian of the SM



$$\mathcal{L} = T - V, \text{ same as always}$$

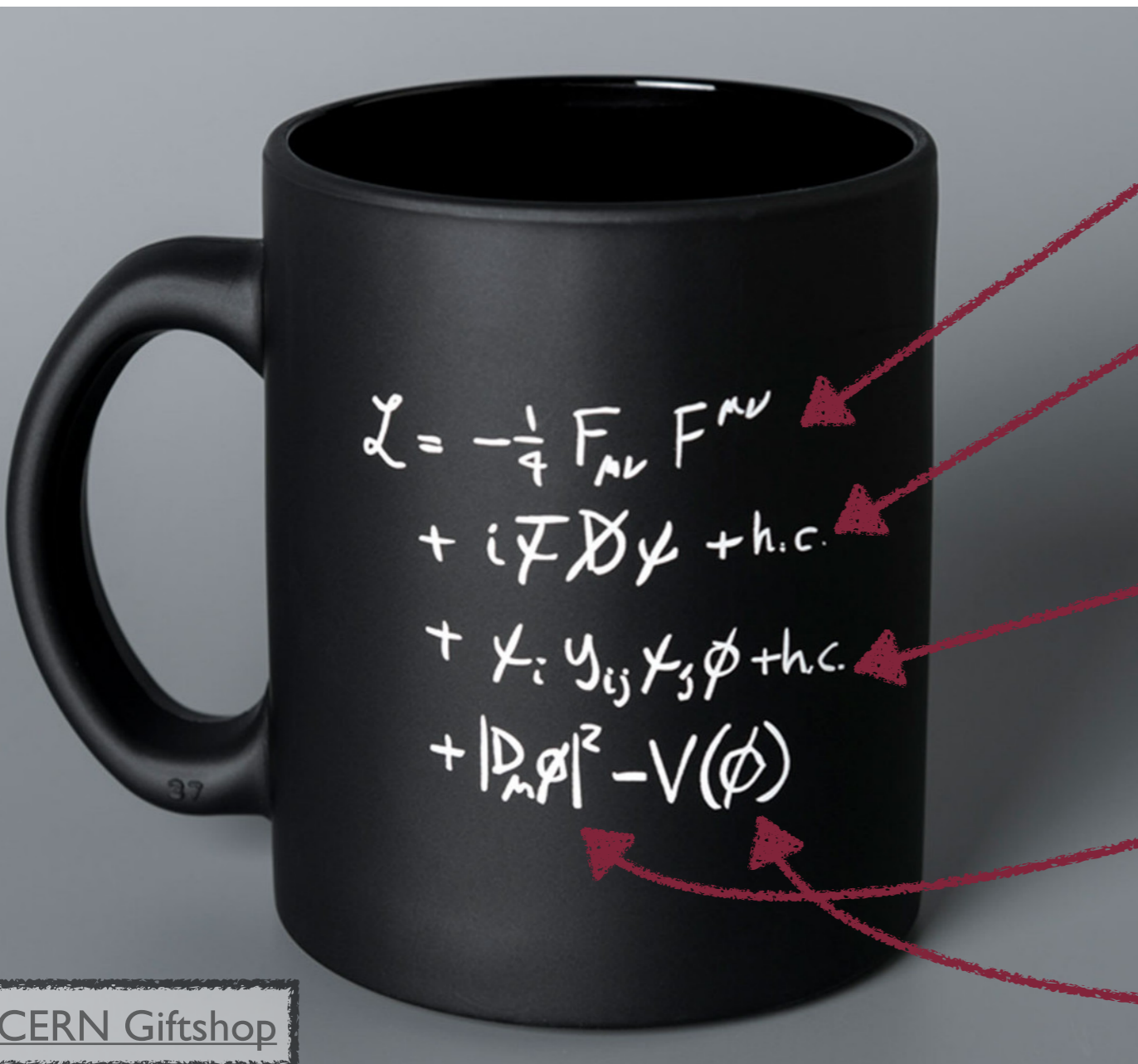

Kinetic term for forces

Kinetic term for matter,
and interaction with forces

Mass term for matter,
via interaction with Higgs (ϕ)

Kinetic term for Higgs (ϕ)

The Higgs Potential

The Higgs Potential



The SM Higgs potential is:

$$V(\phi) = -\mu^2 \phi^2 + \lambda \phi^4$$

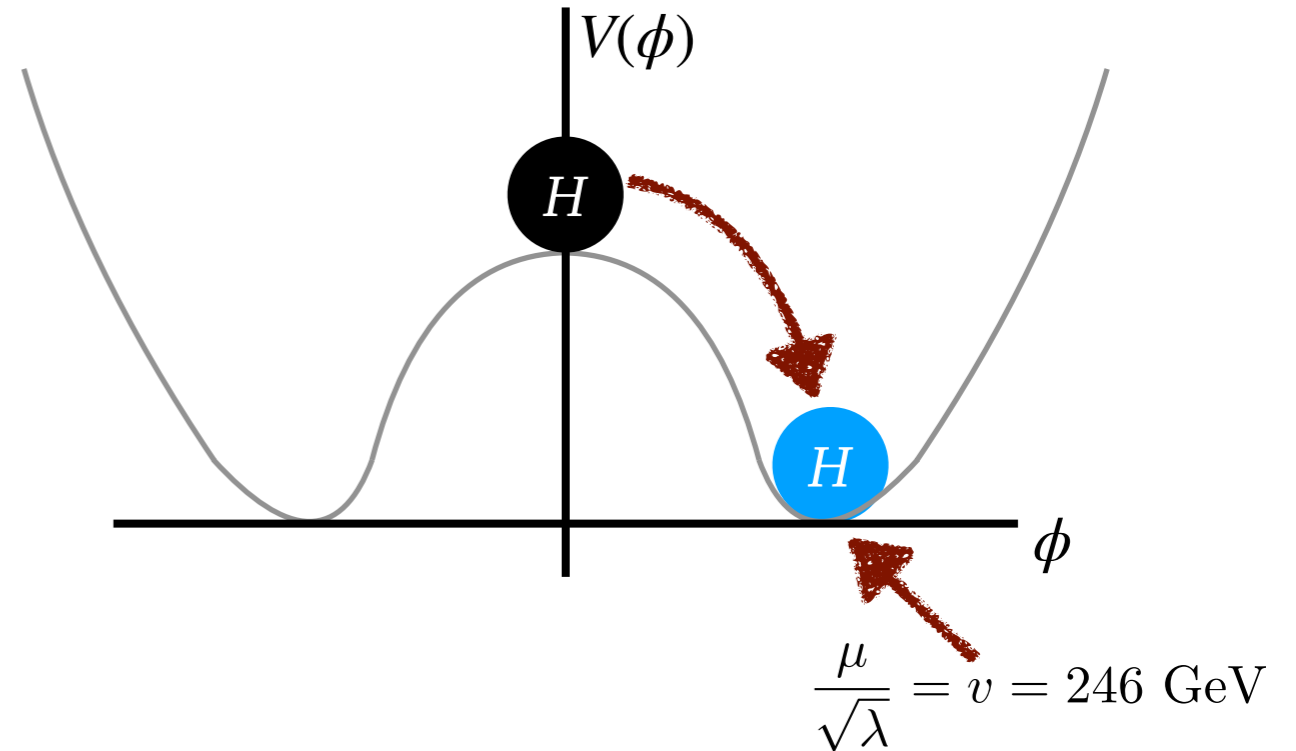

The universe is in an initial ‘symmetric’ state

But it has to go into the lower-energy state, breaking the symmetry

This process creates new interactions, and creates the SM we know:
“Electroweak symmetry breaking”

But is this the *actual* potential realized in nature?

What have we measured?

Measuring the Potential



The SM Higgs potential is:

$$V(\phi) = -\mu^2\phi^2 + \lambda\phi^4$$

We live in the minimum:

$$V = V_0 + \lambda v^2 h^2 + \lambda v h^3 + \dots$$

$$= V_0 + \frac{1}{2} m_H^2 h^2 + \frac{m_h^2}{2v^2} v h^3 + \dots$$

This is a mass term!

So what we've measured is the first term in this series

What's next?

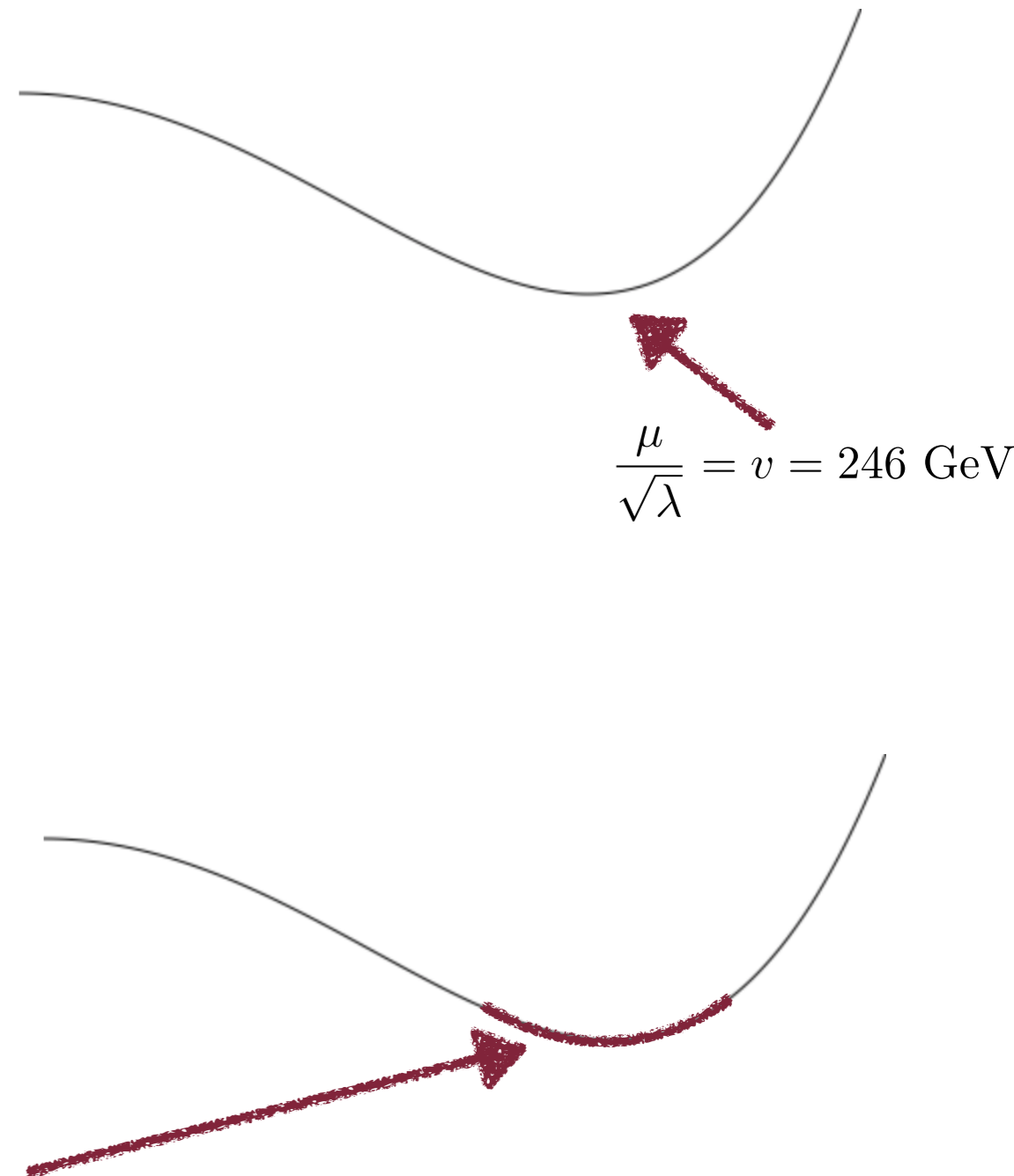

The Next Frontier



$$V = V_0 + \lambda v^2 h^2 + \lambda v h^3 + \dots$$

$$= V_0 + \frac{1}{2} m_H^2 h^2 + \frac{m_h^2}{2v^2} v h^3 + \dots$$

Quadratic terms are masses
Cubic terms are **interactions**

Our expansion describes
a Higgs **self-interaction**

This lets us draw this diagram

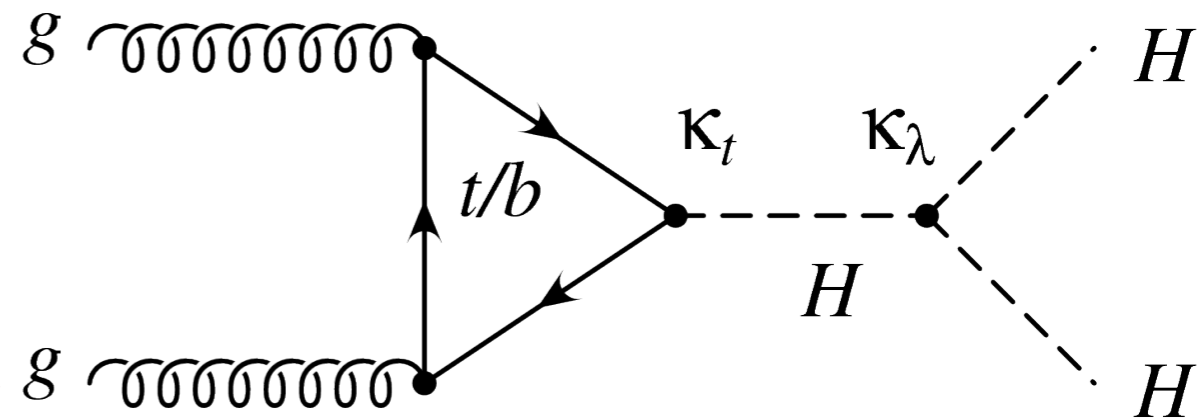

The SM predicts di-Higgs production!

**We can measure the potential
by measuring this coupling**

$$\lambda_{HHH}^{SM} = \frac{m_h^2}{2v^2}$$

$$\kappa_\lambda = \frac{\lambda_{HHH}}{\lambda_{HHH}^{SM}}$$

Not Quite So Easy...

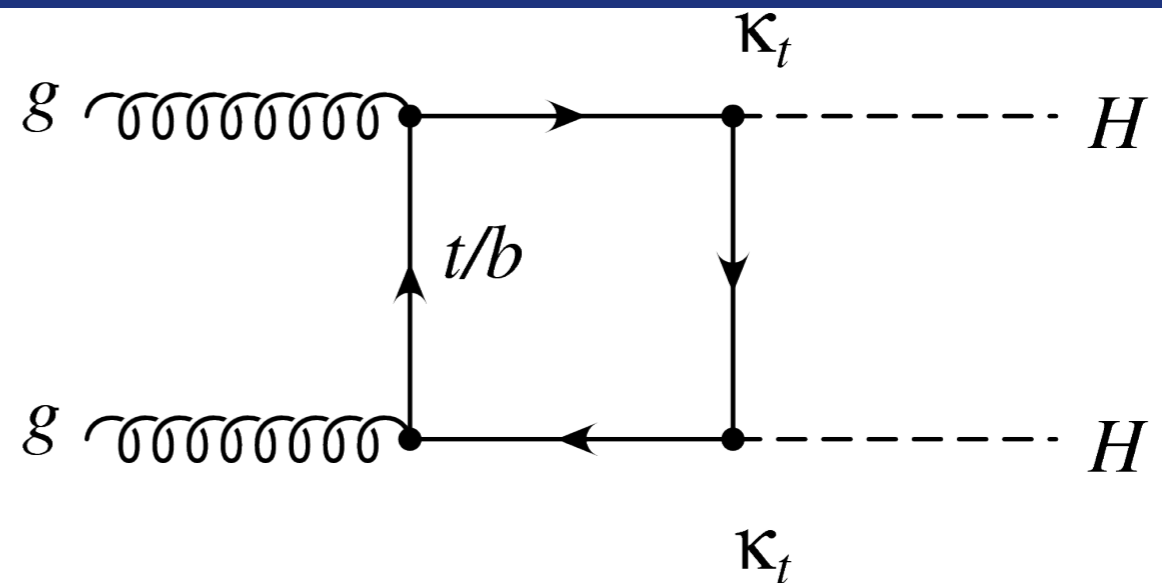
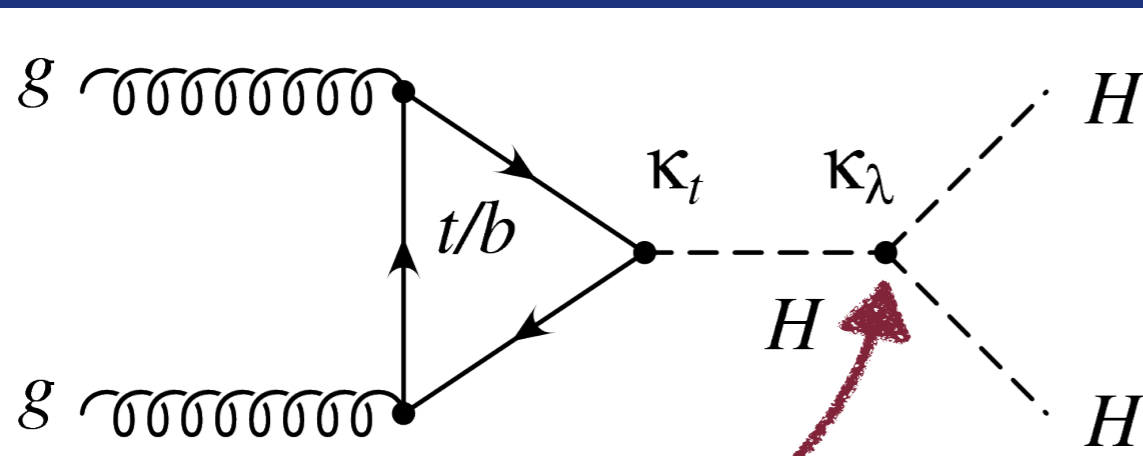

This coupling is what we want to measure

This tells us about the shape of the Higgs potential

This process has the same final state, but κ_λ doesn't appear: no information about the Higgs potential

These two processes destructively interfere in the SM, leading to **very low cross section**: 500x rarer than single Higgs

Di-Higgs production is a **rare process**: perfect for our large datasets!

What Are We Learning?



$$\begin{aligned} V &= V_0 + \lambda v^2 h^2 + \lambda v h^3 + \dots \\ &= V_0 + \frac{1}{2} m_H^2 h^2 + \frac{m_h^2}{2v^2} v h^3 + \dots \end{aligned}$$

Measuring these terms helps us map out the SM's prediction for the Higgs potential

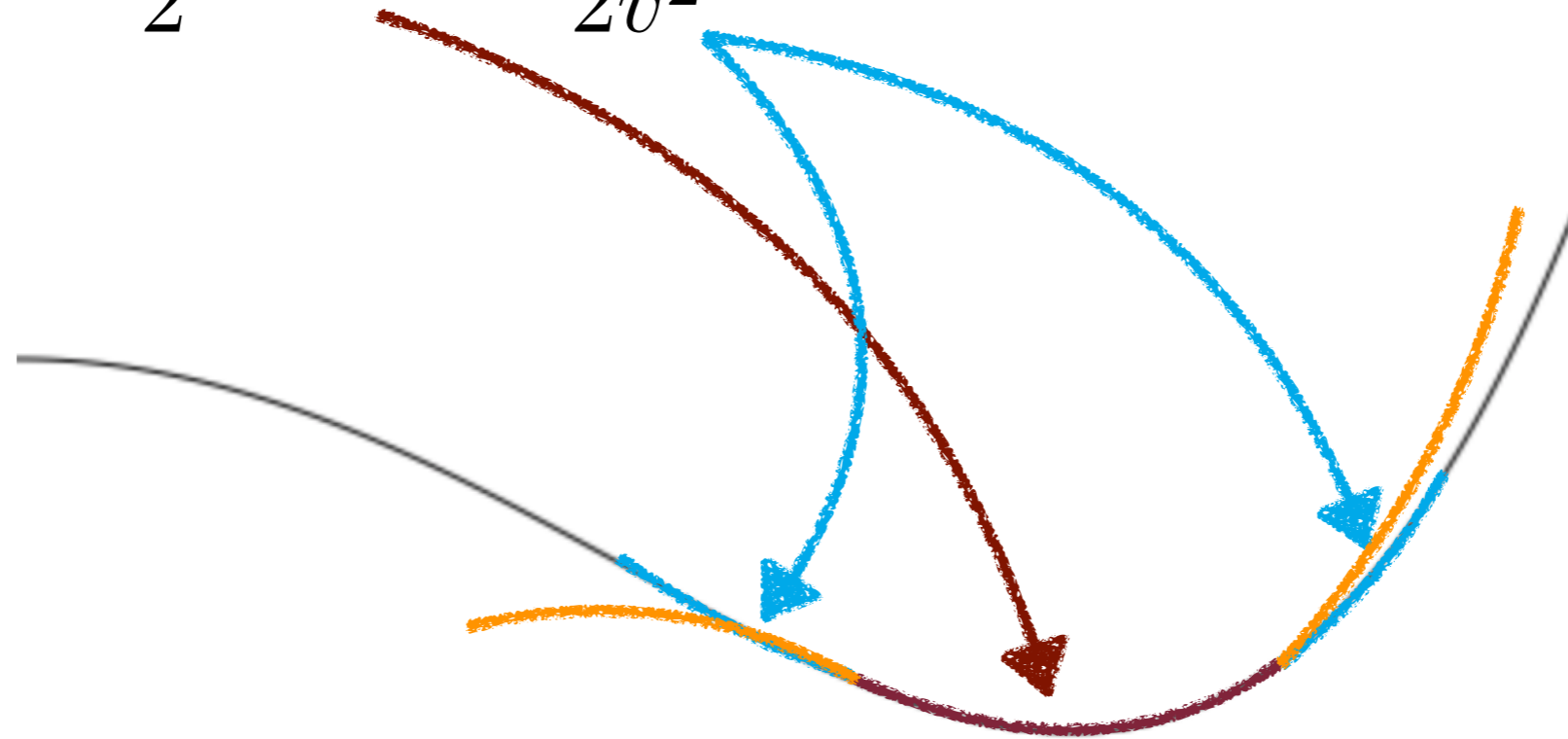

But what if we see something **completely different**?
What if $\kappa_\lambda = 3$?

Other Shapes?

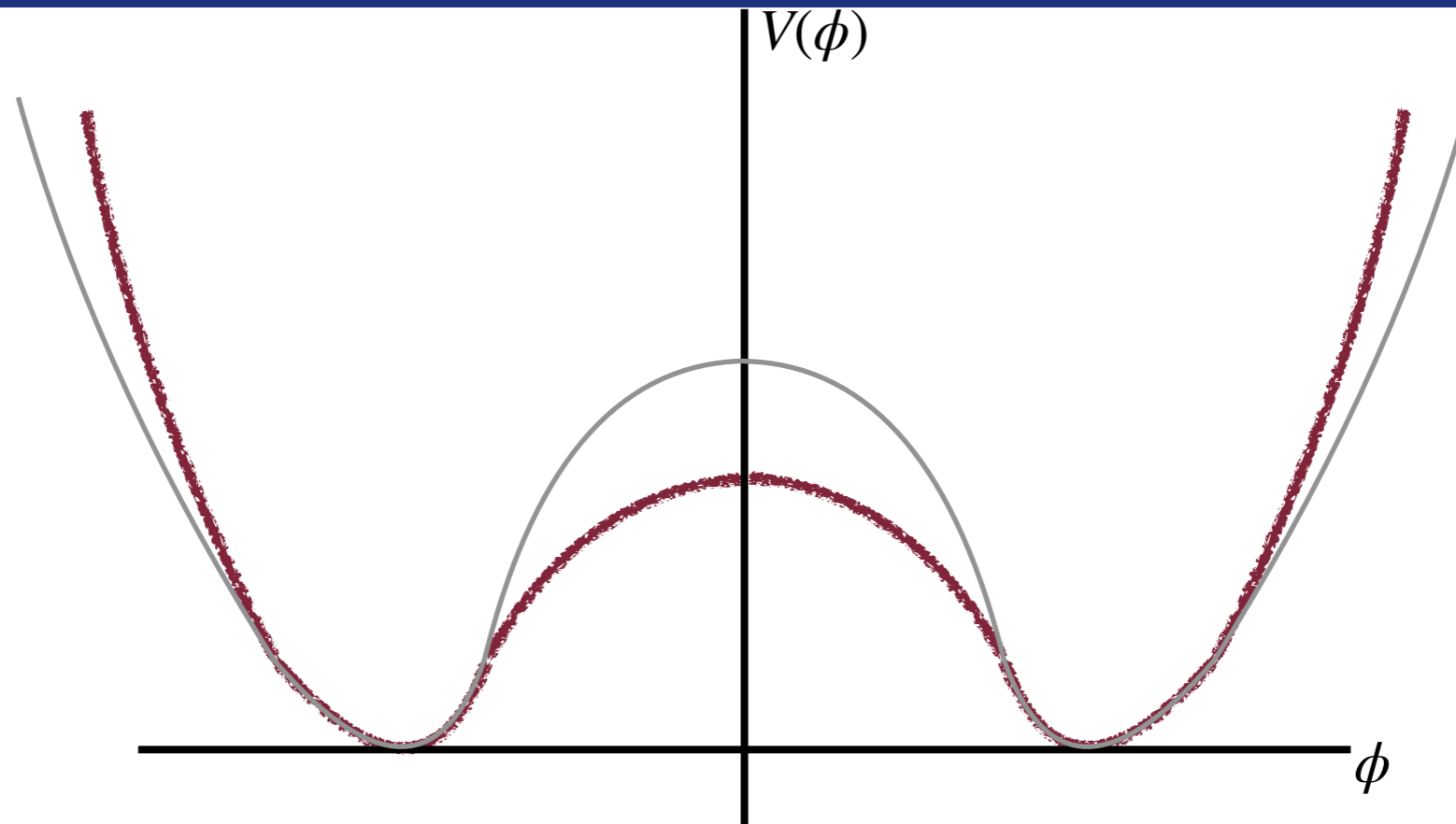

We have a prediction for the shape from the SM...

But **other shapes** of the potential still allow for
Electroweak Symmetry Breaking

They still lead to the same Higgs mass

What physics could this lead to?

The Electroweak Phase Transition

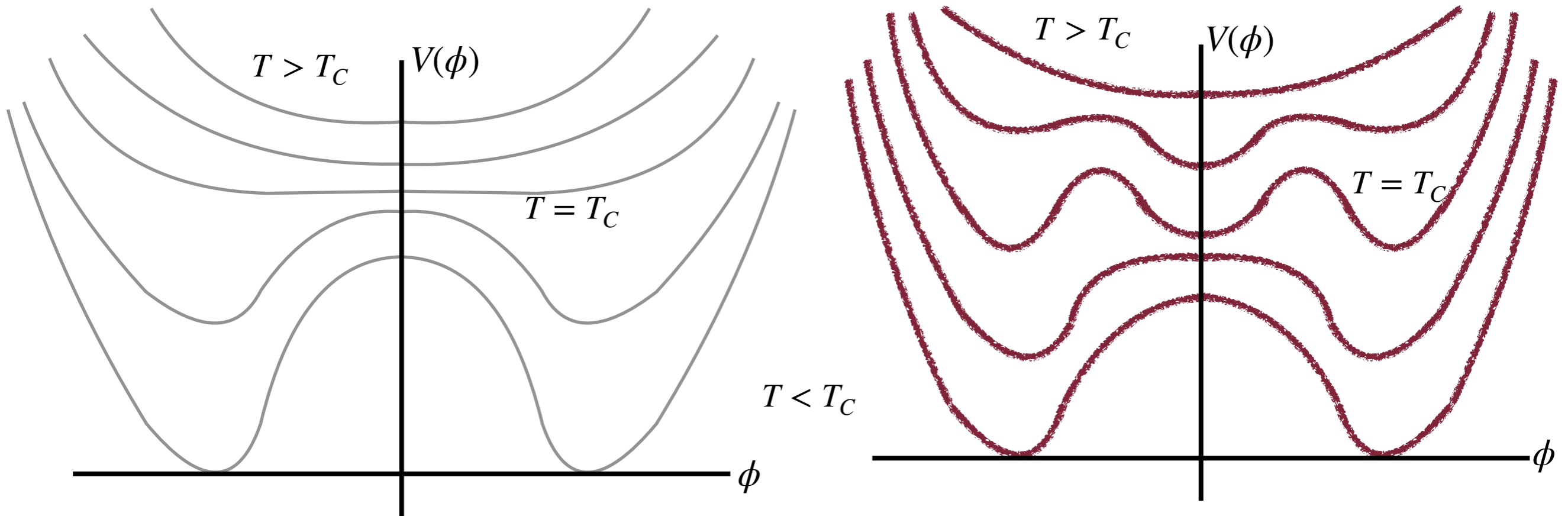

What happens as we increase the temperature:
Go back in time towards the Big Bang

Both the SM, and modified models, undergo a **phase transition**

The SM has a smooth transition, while modified models have a '**barrier**'

Modified models lead to **out of equilibrium dynamics**
in the early universe

Adapted from T.Tait and G.White

Broken Symmetries



The matter/anti-matter problem is a **broken symmetry**

We've already measured one broken symmetry:
this is **electroweak symmetry breaking**

What if these two broken symmetries are related?

Can the electroweak phase transition remove
anti-matter from the universe?

BSM models that enable this are referred
to as **Electroweak Baryogenesis**

Electroweak Baryogenesis

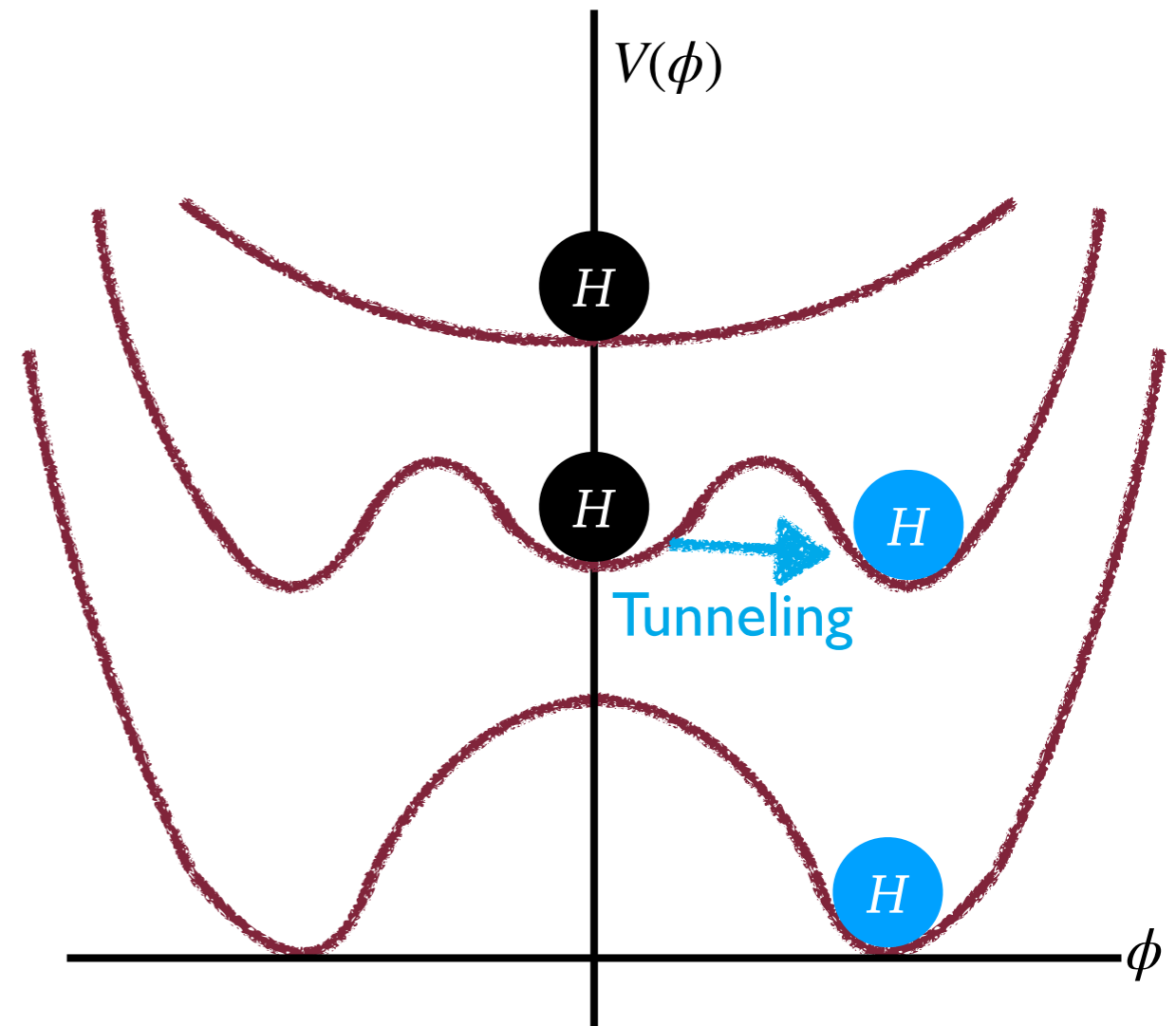
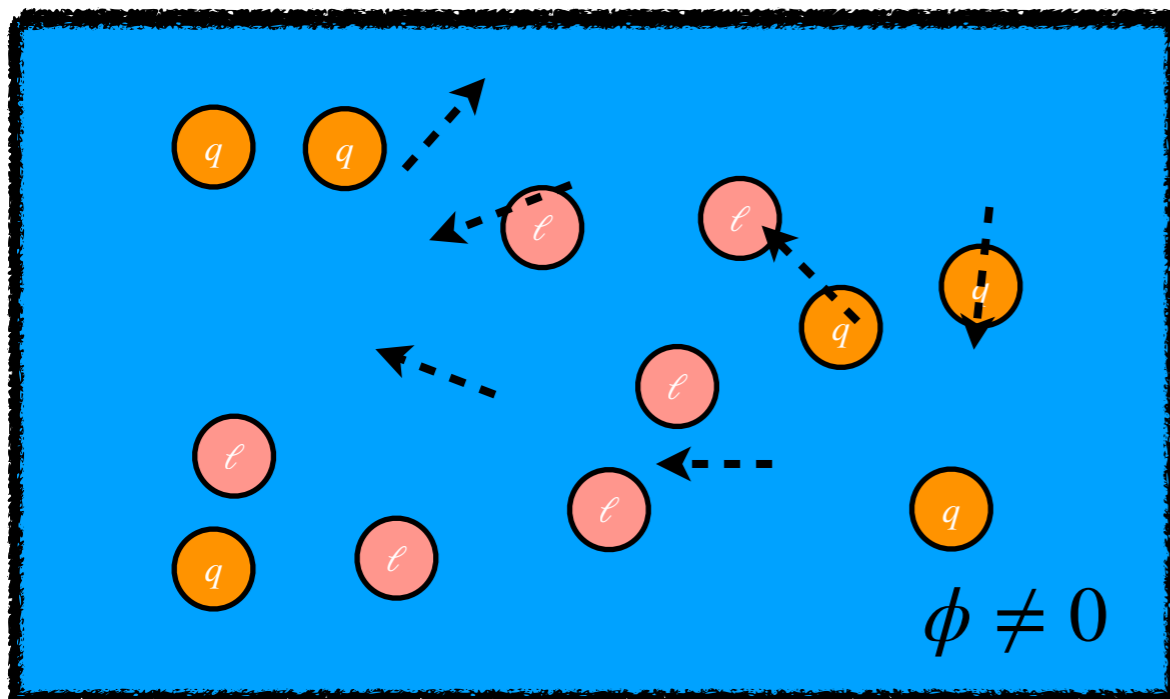
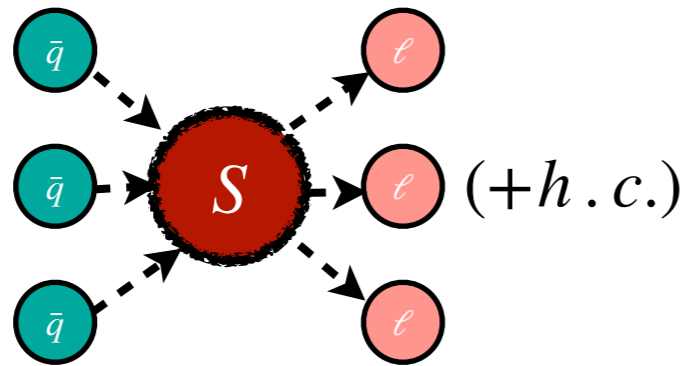

Step 1: High-temperature (MB) requires BSM (e.g. GUTs, SUSY, or other) to break CP (e.g. via CP-violating phases) and generate CP violation
 Step 2: Bubble nucleation (MB) requires BSM (e.g. GUTs, SUSY, or other) to break CP (e.g. via CP-violating phases) and generate CP violation
 Step 3: Sphaleron transitions (MB) require BSM (e.g. GUTs, SUSY, or other) to break CP (e.g. via CP-violating phases) and generate CP violation
 Step 4: Washout (MB) requires BSM (e.g. GUTs, SUSY, or other) to break CP (e.g. via CP-violating phases) and generate CP violation

These processes don't occur in the $\phi = 0$ state. **Electroweak symmetry breaking leads to matter asymmetry.**

The Higgs Potential and EWBG

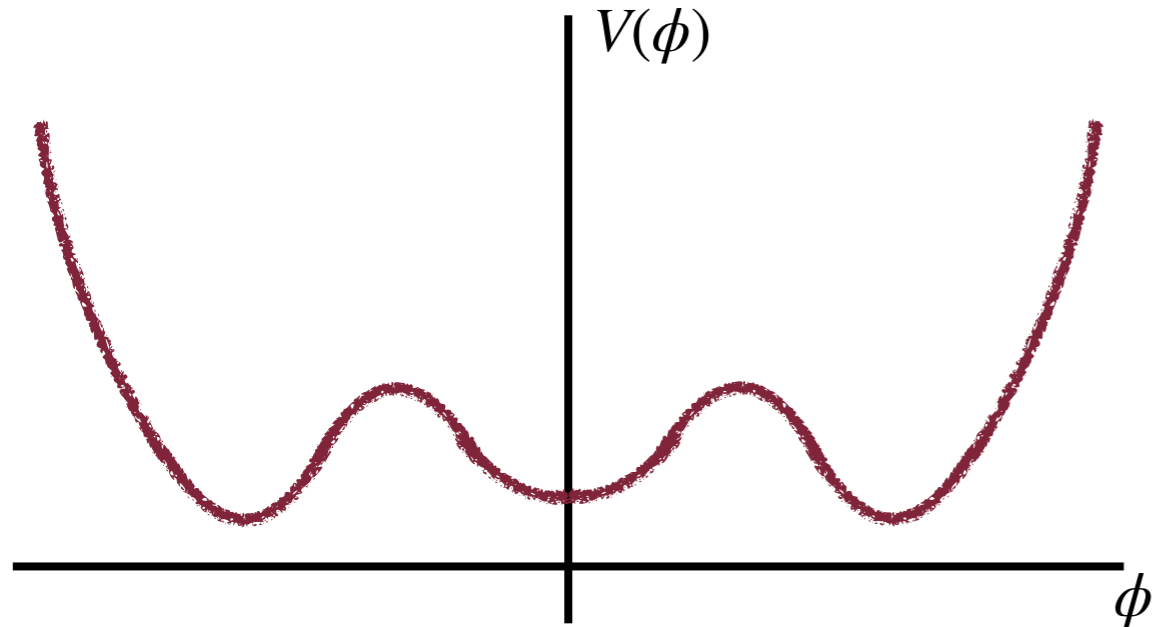

The shape of the Higgs potential at T_C is critical: needs to be a first-order phase transition

Can't smoothly crossover the whole universe at once: need 'bubbles' of broken symmetry

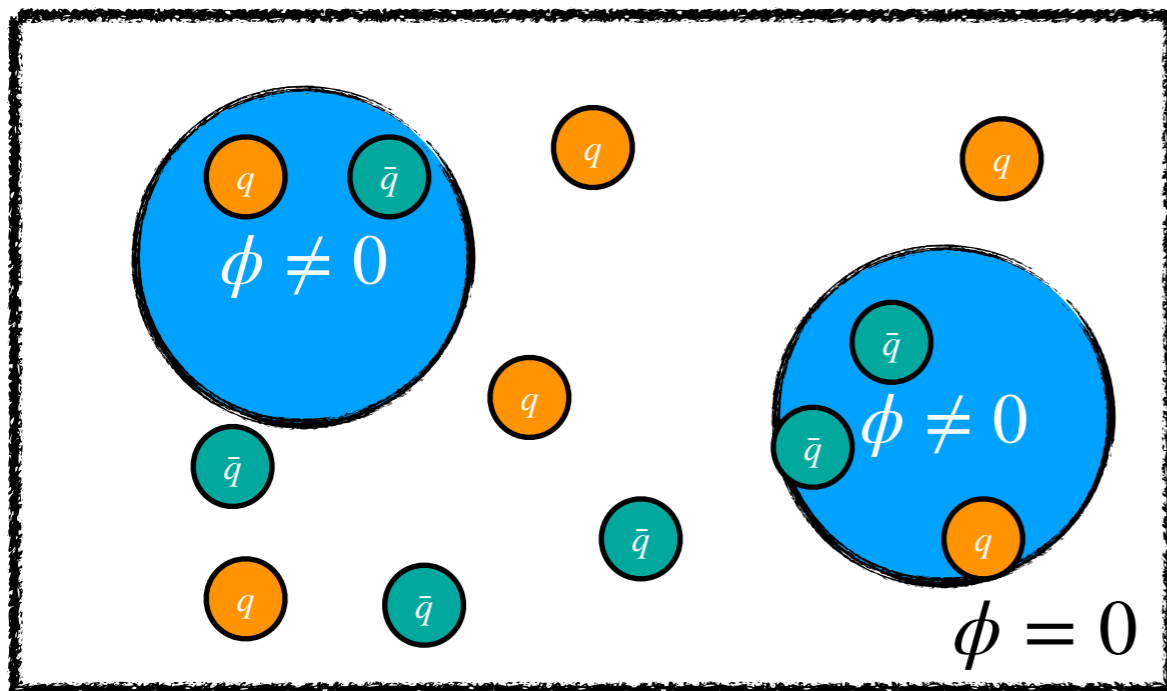

We need a modified Higgs potential to enable this first order transition:
 κ_λ could be between 1.2 and 6
(very roughly!)

And we could see this at the LHC with di-Higgs!

Is the Universe Stable?

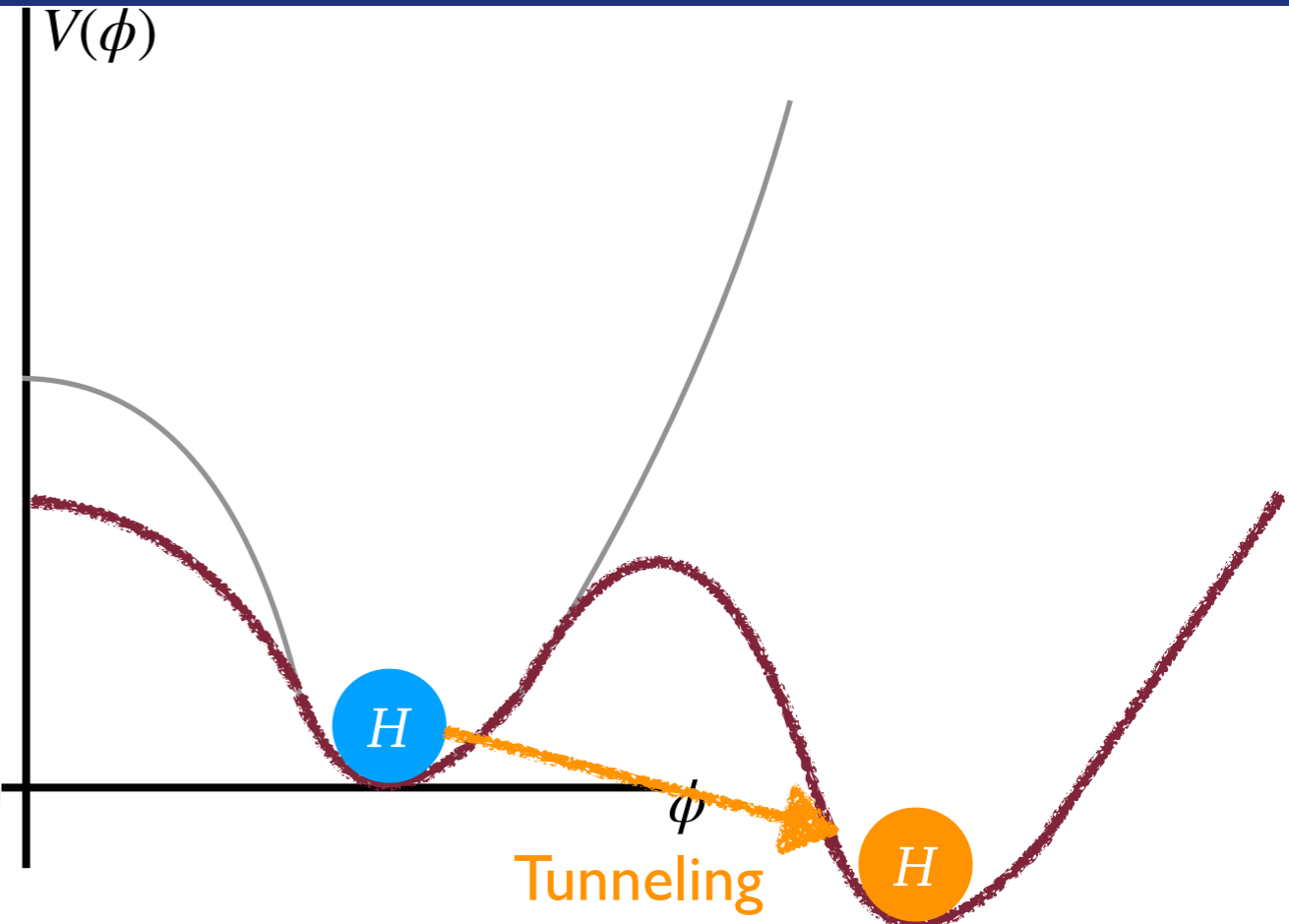
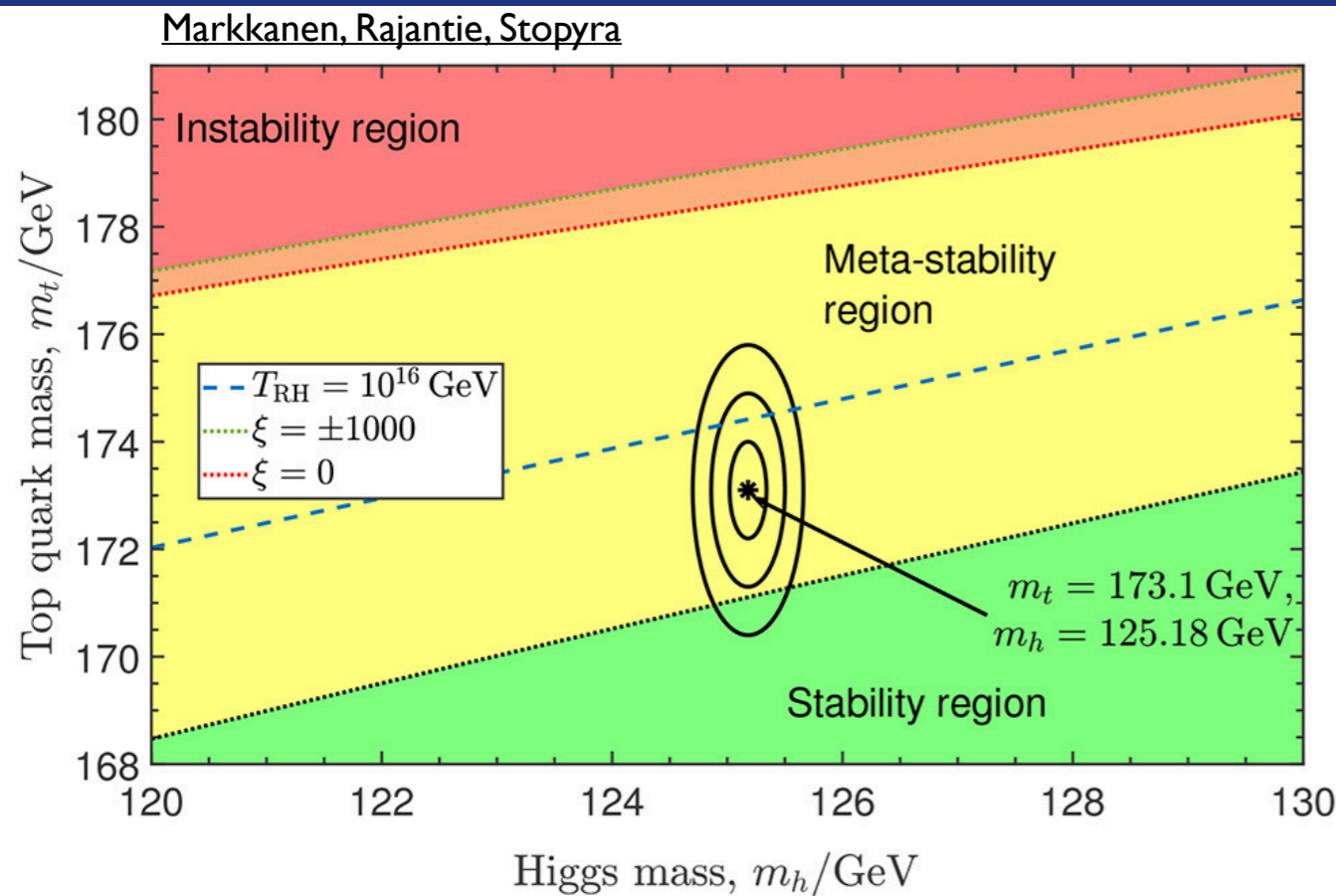

If the only field in the universe was the Higgs, an SM-like potential would be *stable*: our minimum is the global minimum

Quantum corrections (i.e. interactions with other particles) mean that the effective shape can be quite different

Even in the SM, our universe might only be *meta-stable*: able to tunnel to a lower energy state!

Measuring the potential as best as we can is critical: BSM physics can move our universe between stability and instability

The Higgs is still new and not fully explored
What can we learn from this new particle?
We can measure the Higgs potential

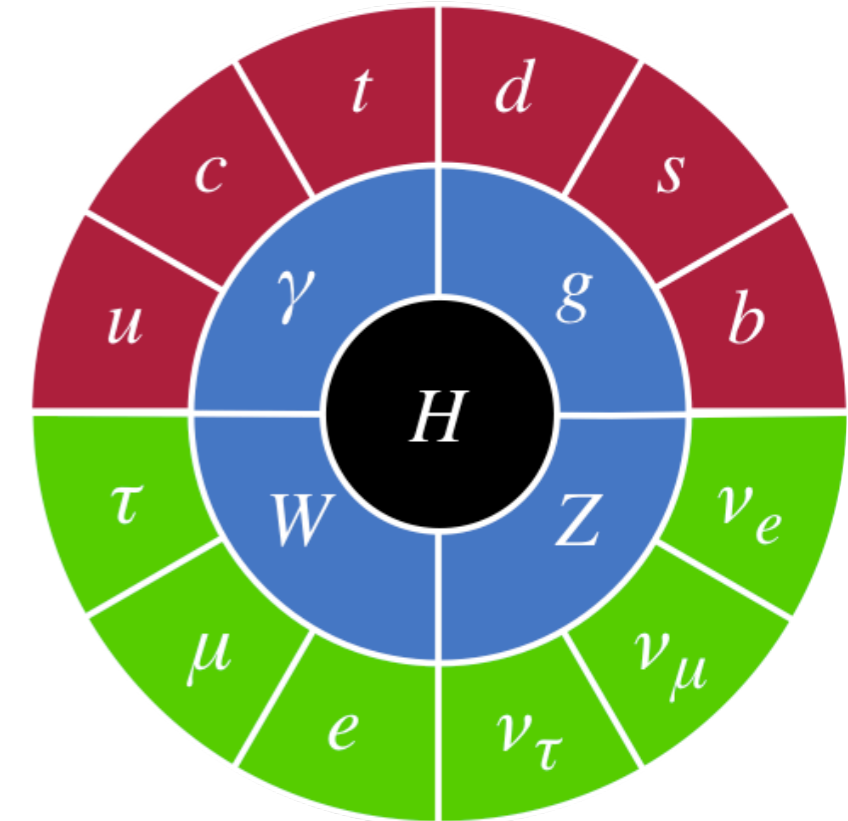

We know the SM is incomplete:
Where's the missing anti-matter?
Is the universe stable?
**The shape of the Higgs potential
may be key to the birth and fate
of the universe**



**Higgs pairs are the next frontier to understanding
the Standard Model and Beyond**

The LHC Context

What Do We
Look For?

The Next Frontier:
Higgs Pairs

Outlook

What Does This Look Like?



The Higgs decays instantly, to a range of particle types

Higgs pairs are rare, and have a hugely rich structure of final states

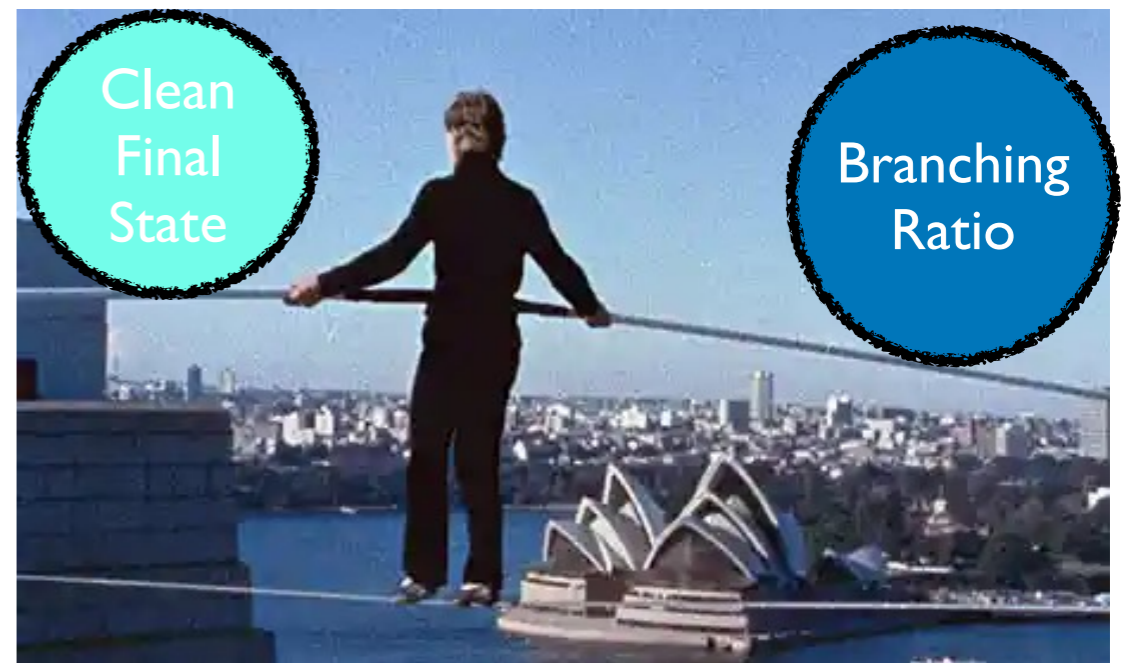
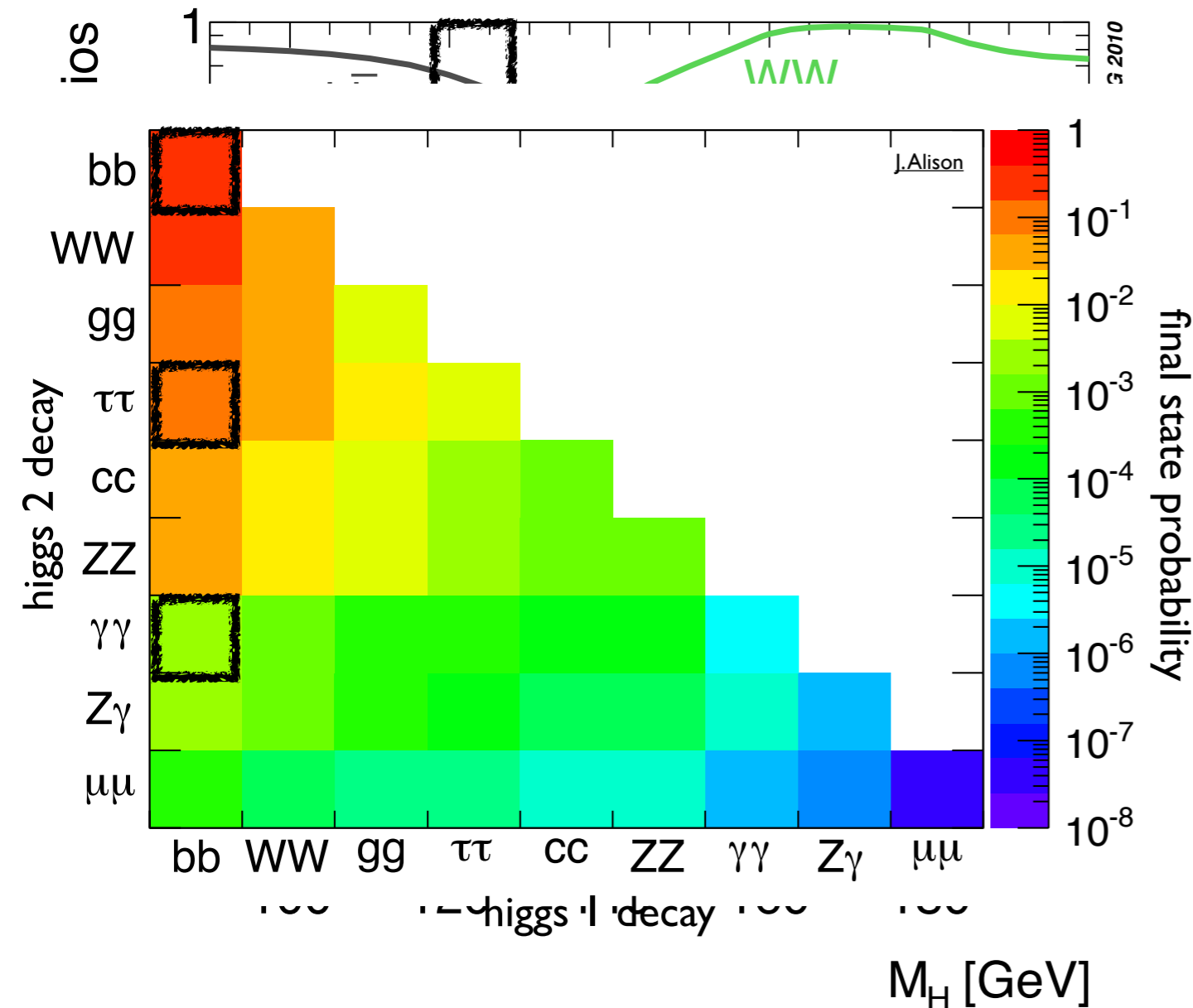

Man on Wire, Guardian

$4b$, $b\bar{b}\tau\bar{\tau}$, and $b\bar{b}\gamma\gamma$ are the most powerful

The ATLAS Detector

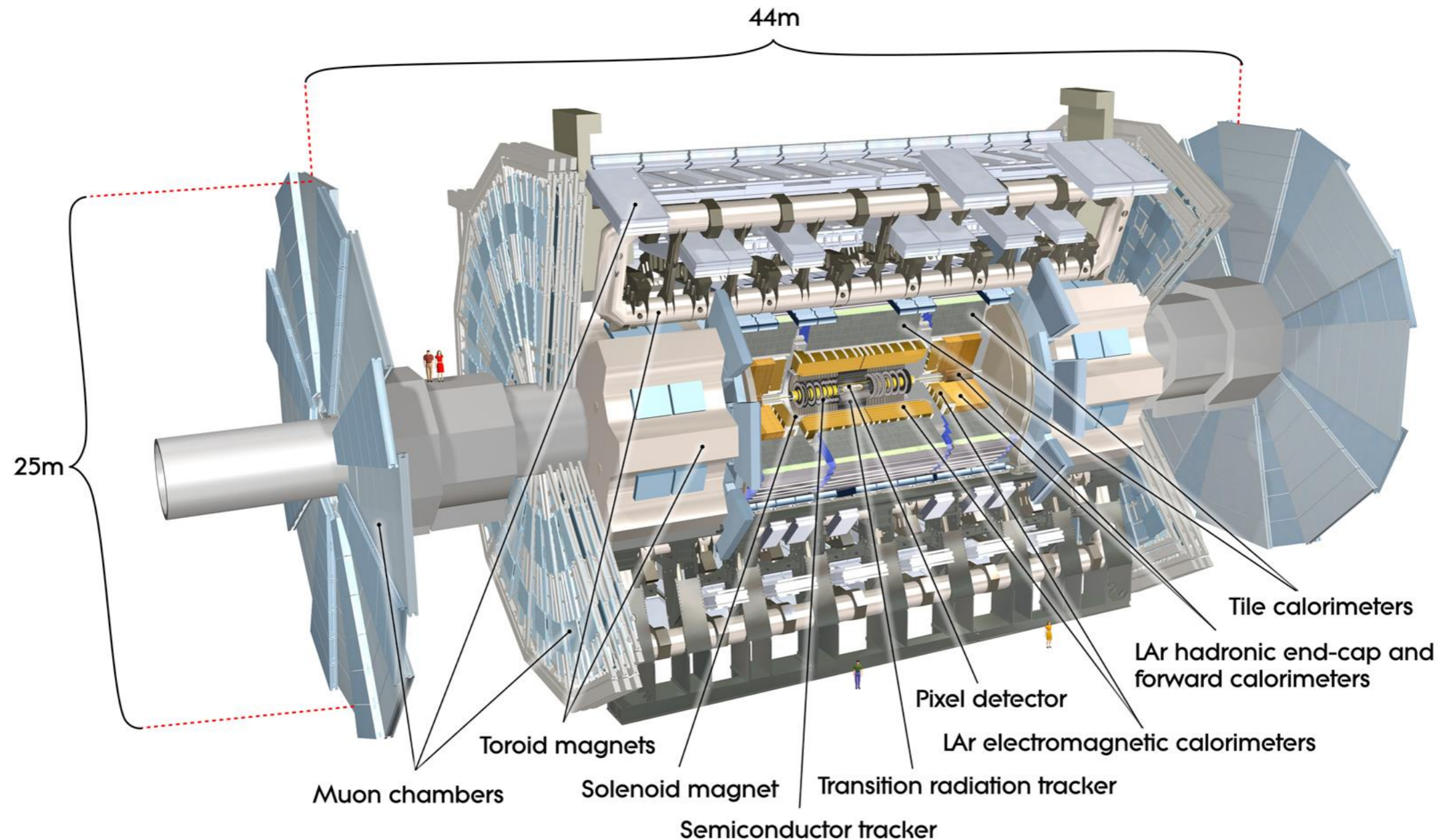

Collisions, to Physics

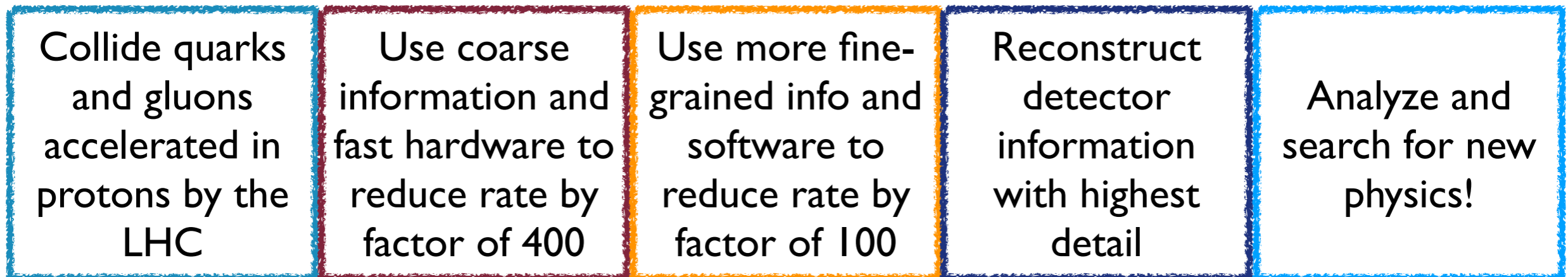

Searching with ATLAS



**Hadronic
Calorimeter**

**Muon
Spectrometer**

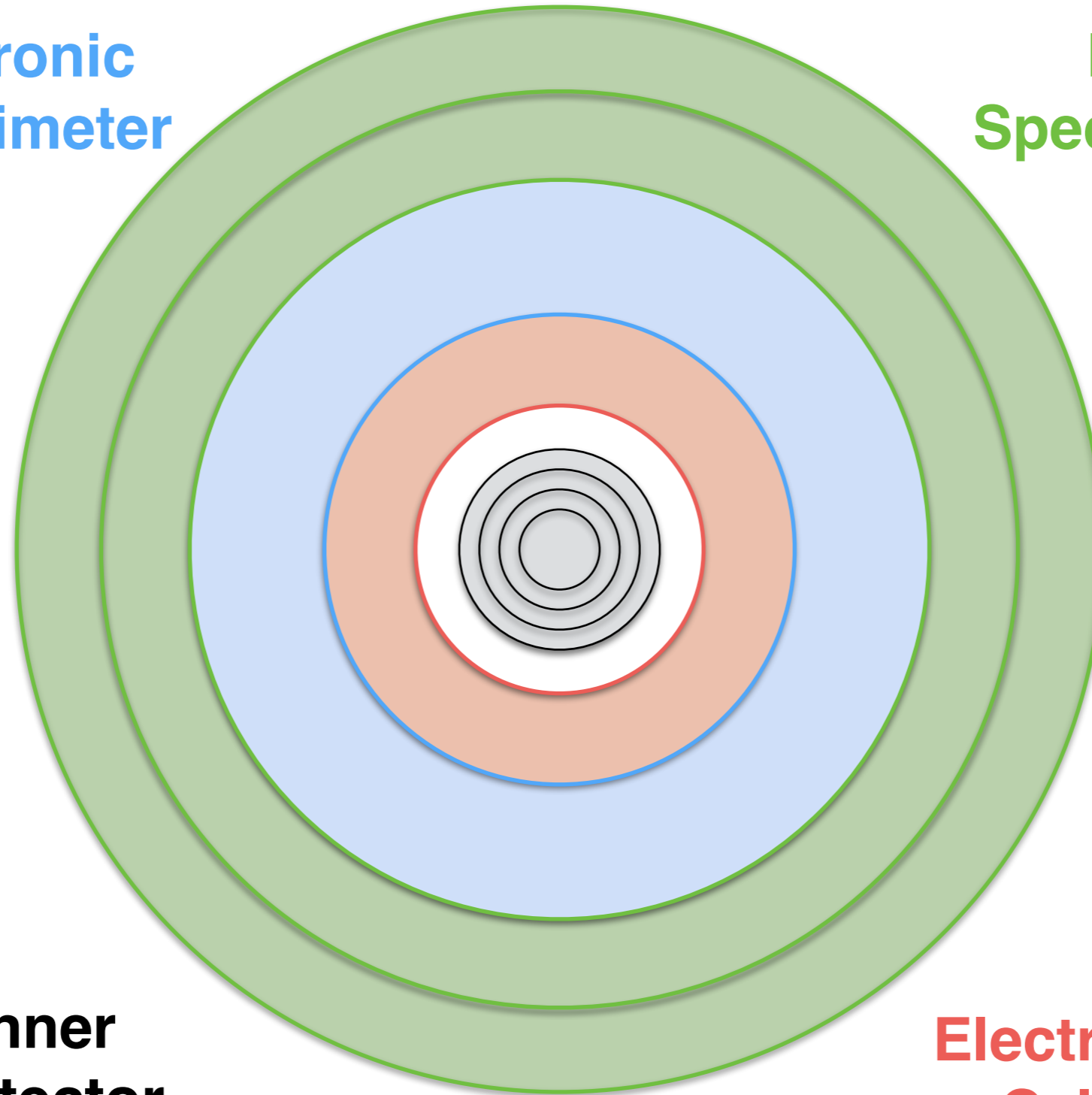

**Inner
Detector**

**Electromagnetic
Calorimeter**

Searching with ATLAS



Tau

Single or triple prong
decay to pions: tracks
and calorimeter deposits

Muon

Inner detector track
matched to muon
spectrometer track

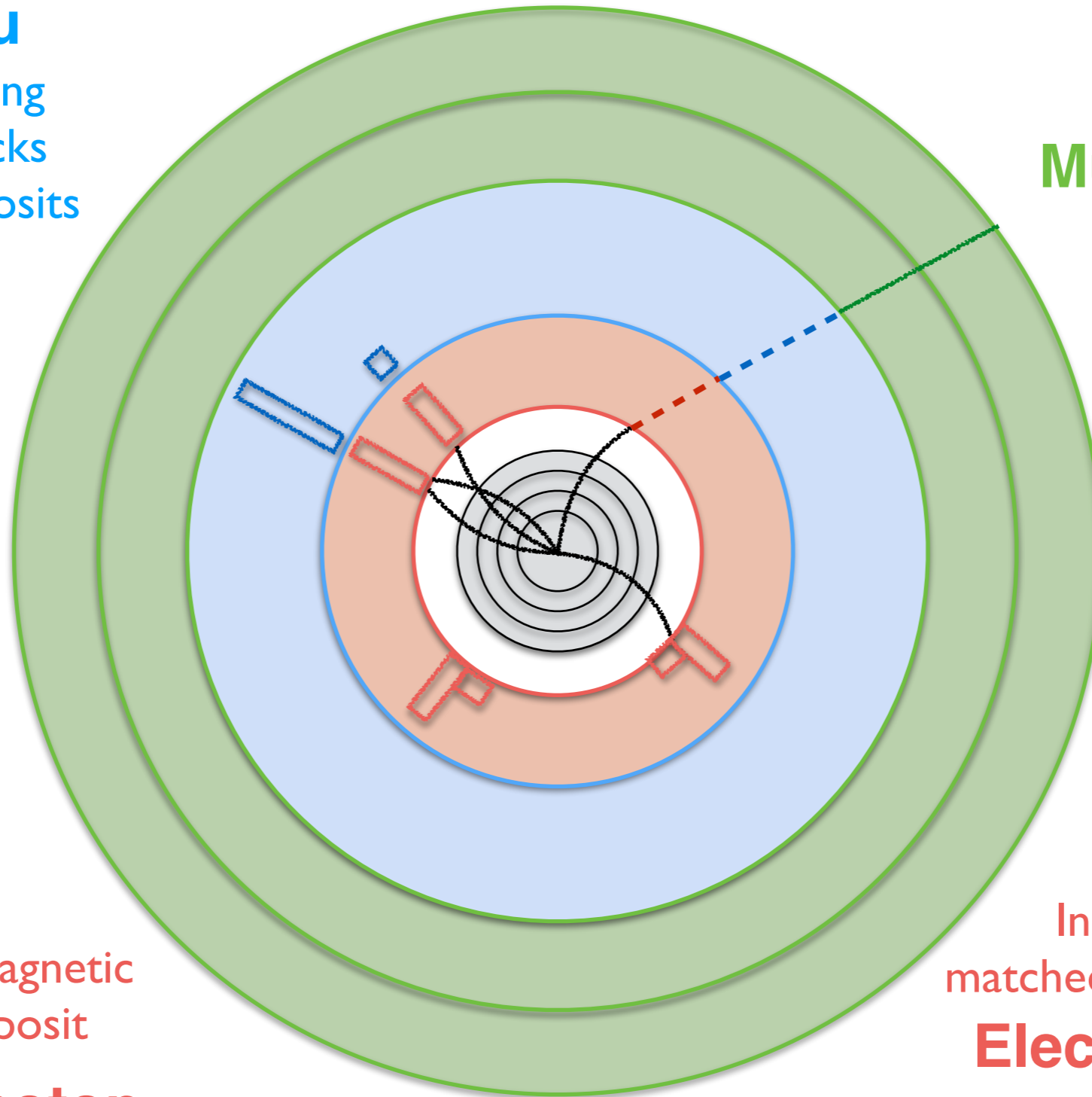

Isolated electromagnetic
calorimeter deposit

Photon

Inner detector track
matched to calorimeter deposit

Electron

An Aside: Jets



Image credit: B. Nachman

When quarks or gluons are produced during a collision...



They “shower”
into more gluons and quarks...

We refer to these
showers as “jets”

Which “hadronize” into
stable (or unstable particles)

Searching with ATLAS



Jet

Spray of particles
initiated by quark or gluon,
measured in calorimeter

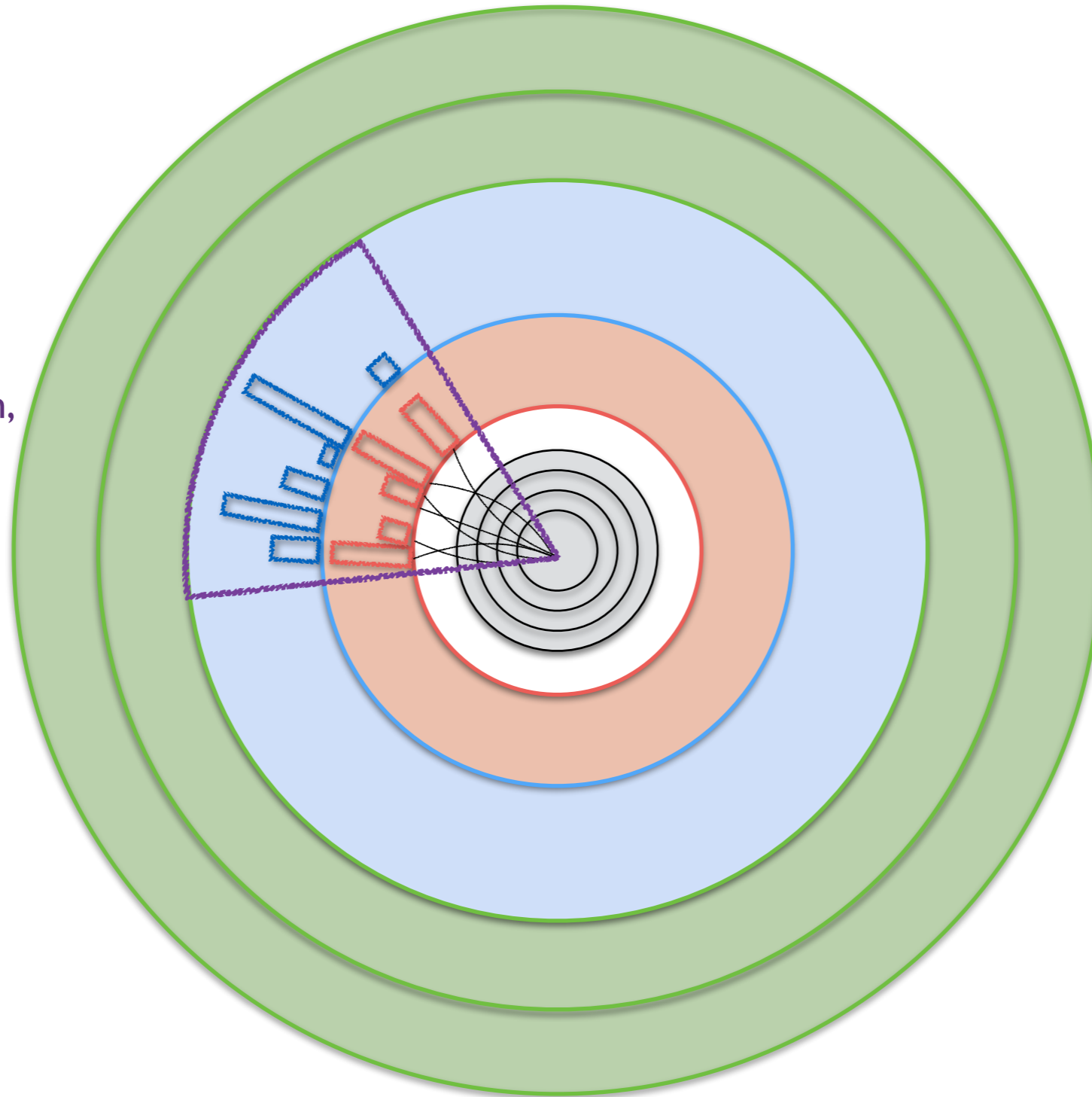

ATLAS Jet Performance

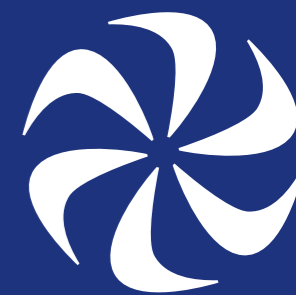

Eur. Phys. J. C 81 (2021) 689

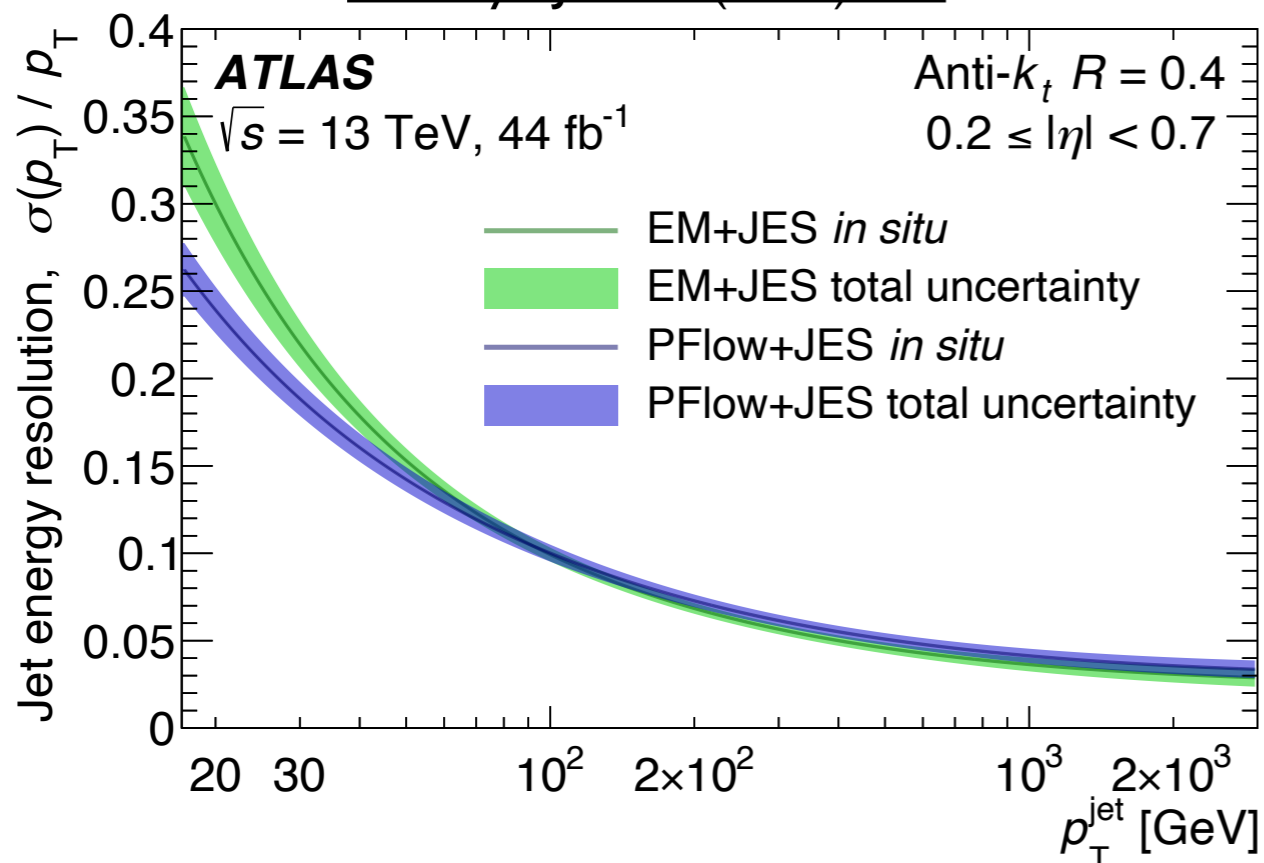

JETM-2022-005

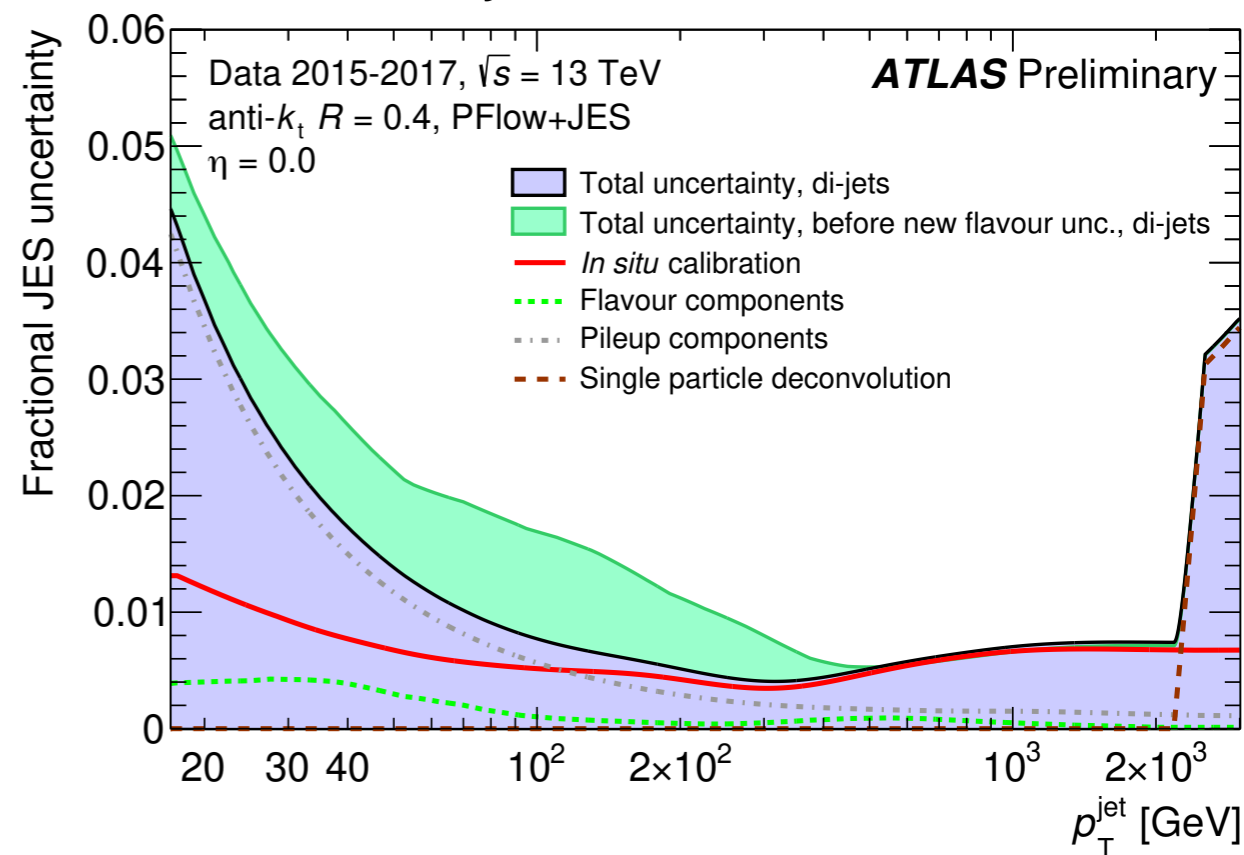

ATLAS now utilizing
 PFlow reconstruction: significant
 resolution improvements at low p_T

New flavour uncertainty
 treatment and MC/MC
 calibrations lead to sub-%
 uncertainties above 80 GeV

Searching with ATLAS

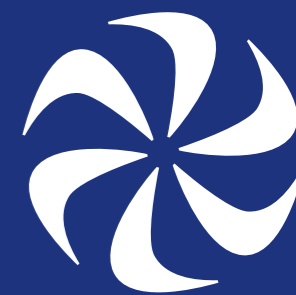

b-jet

Jet initiated by a b-quark,
which form B-hadrons
with long lifetimes
and displaced vertices

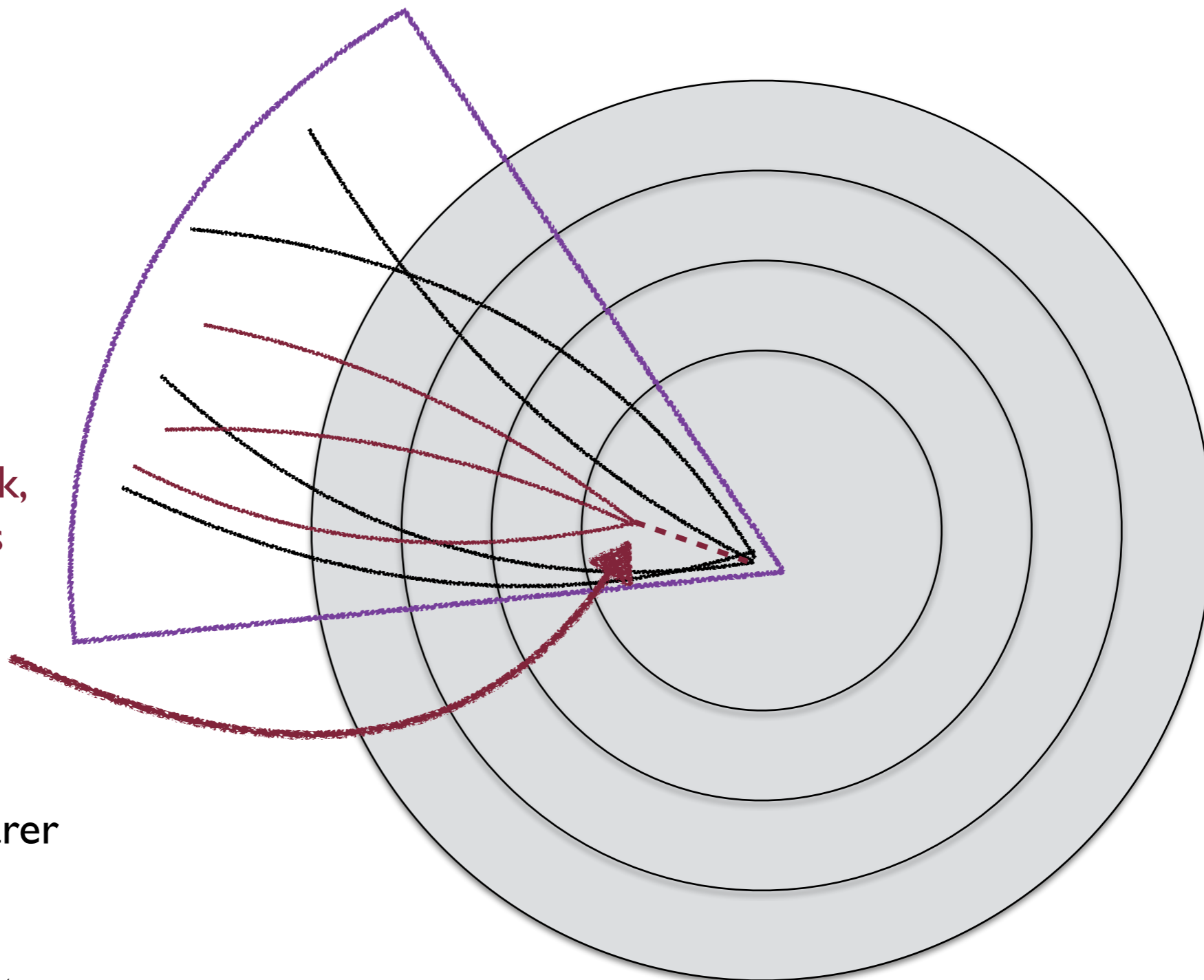

Jets are common,
but b-jets are much rarer

The most common
Higgs decay is to b-jets:
Can use this to find our signal!

b -Tagging Performance



arXiv:2211.16345

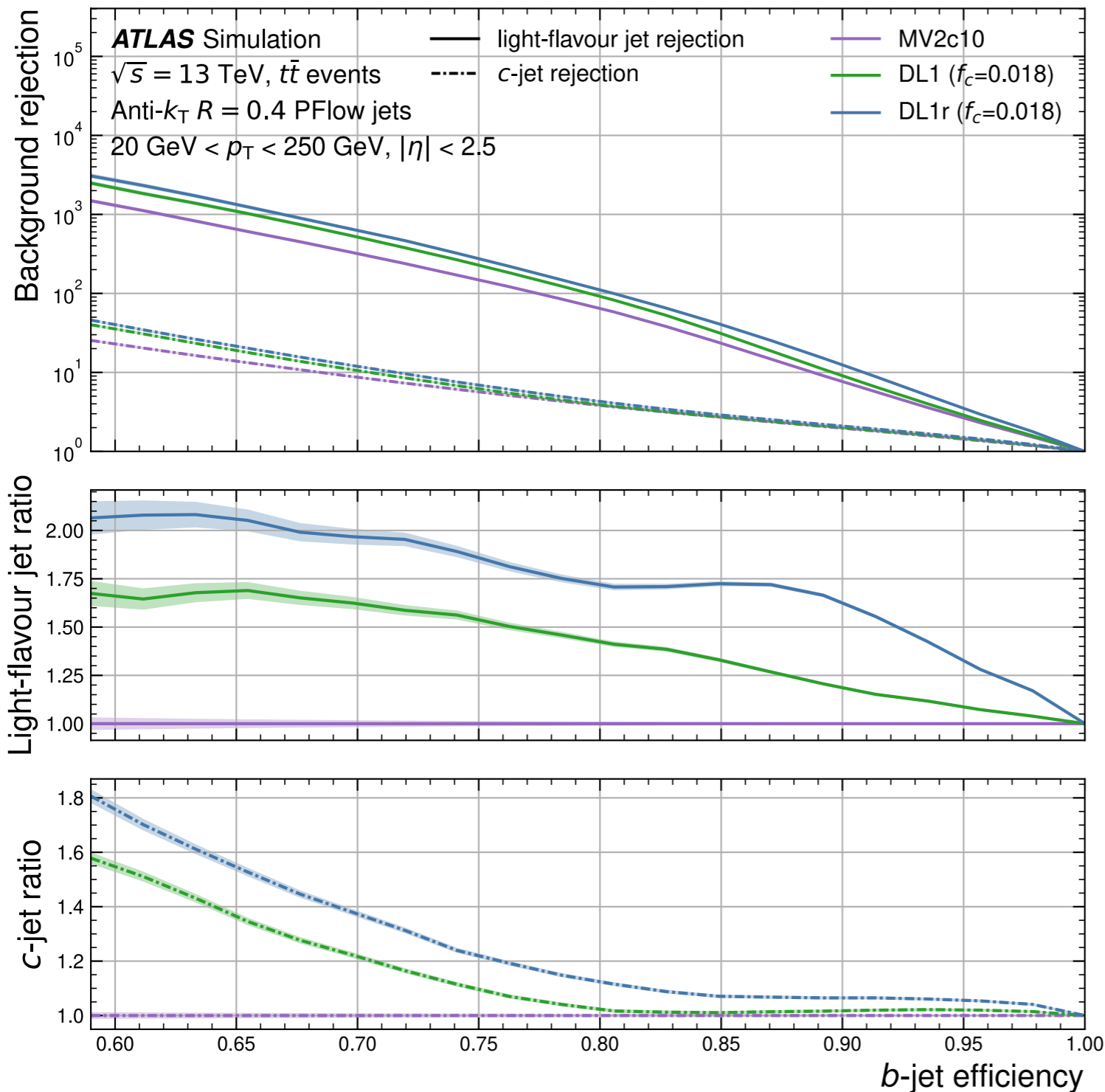

To quantify performance, show *background rejection* as a function of *b-jet efficiency*

DL1r is the Run2 ATLAS b -tagging algorithm: Combines several low-level vertexing inputs

Outperforms older BDT **MV2** by nearly a factor of 2!

Searching for Higgs Pairs

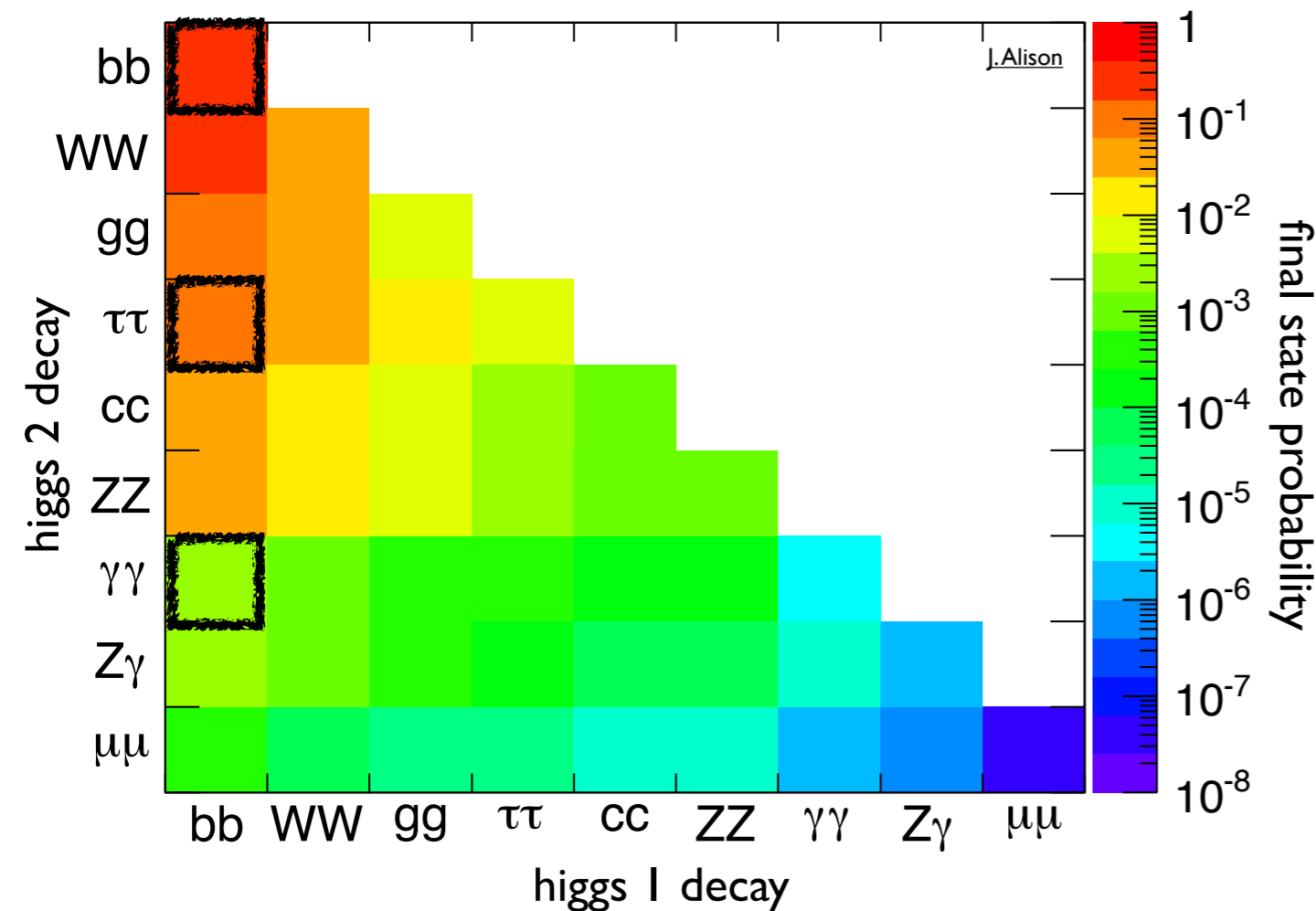

Many channels are competitive in measuring di-Higgs production:
No golden channel

Today, showing results from several recent analyses:

$$HH \rightarrow b\bar{b}\gamma\gamma$$

$$HH \rightarrow b\bar{b}\tau\bar{\tau}$$

$$HH \rightarrow b\bar{b}b\bar{b}$$

And their combination!

What Does κ_λ Look Like?

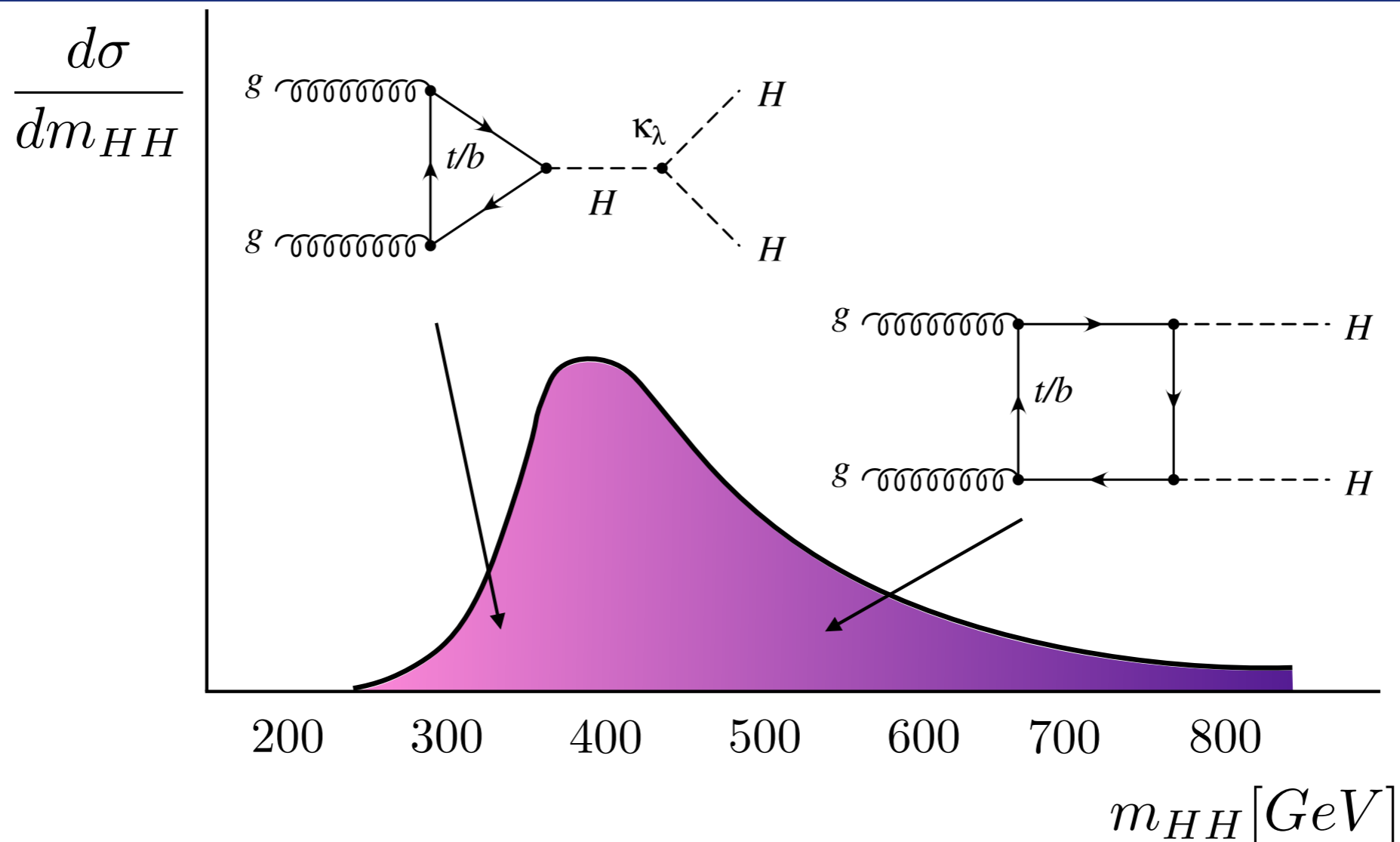

Signal distribution strongly depends on κ_λ

Increasing κ_λ leads the 'triangle diagram' to dominate:
 signal peak shifts to lower m_{HH}

What Does κ_λ Look Like?

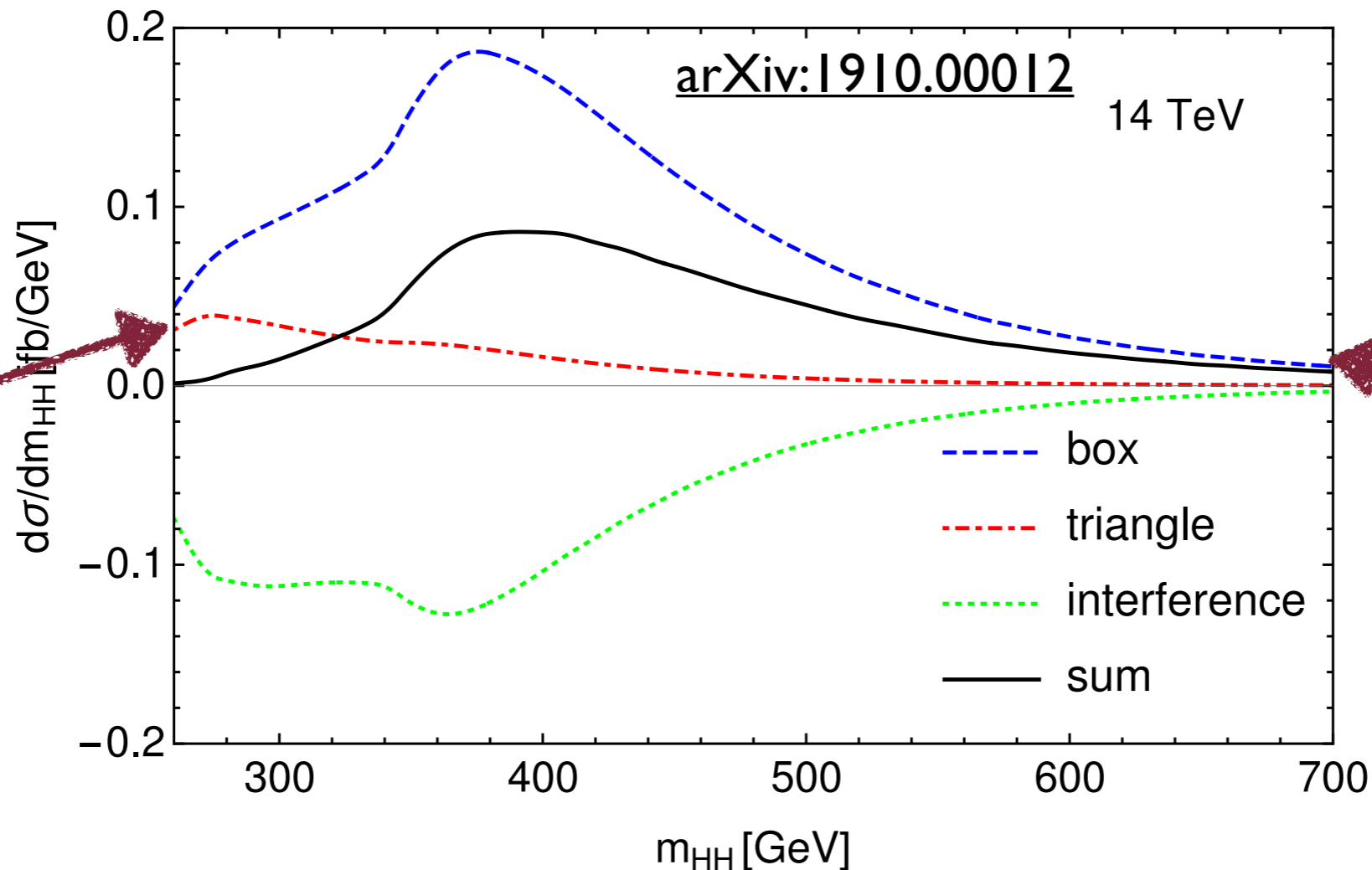

Measuring at high m_{hh} gives you sensitivity only to the **box**

Measuring at low m_{hh} gives access to the **triangle**, and κ_λ

Shapes your analysis strategy:
need low p_T triggers and shape information

$$HH \rightarrow b\bar{b}\gamma\gamma$$

Trigger on diphotons
($E_T > 35,25$ GeV)

Cleanest signature possible:
low signal rate, but low bkgds too!

Require two photons
(Leading (subleading) $p_T/m_{\gamma\gamma} > 0.35$ (0.25))

Select < 6 jets
($p_T > 25$ GeV, $|\eta| < 2.5$)

Require 2 b-tagged jets
($\epsilon = 77\%$)

$b\bar{b}\gamma\gamma$ Analysis Strategy

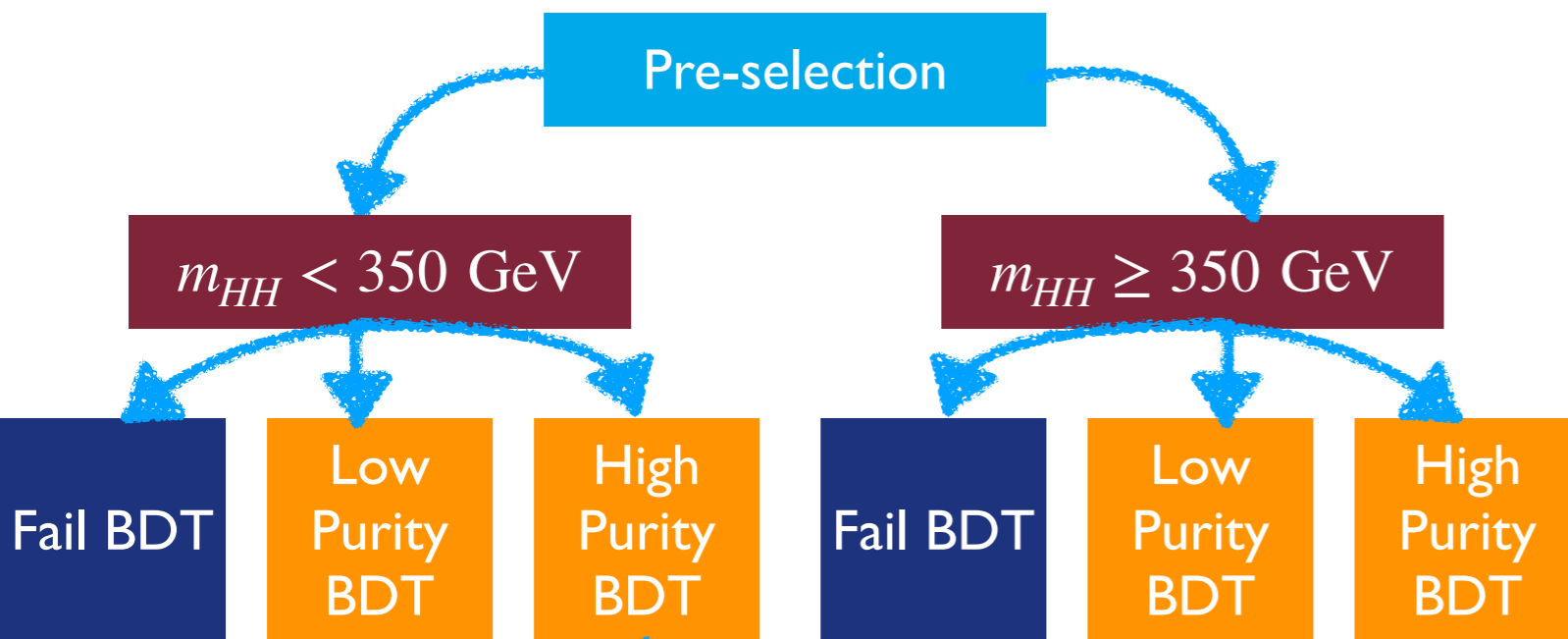
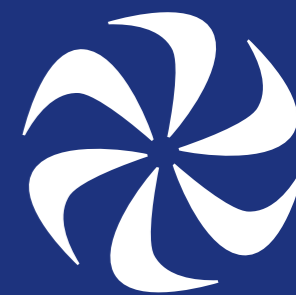

After **pre-selection**, split into **high-mass** and **low-mass** selections

BDT trained in each region: select low- and high-purity **signal regions** with BDT

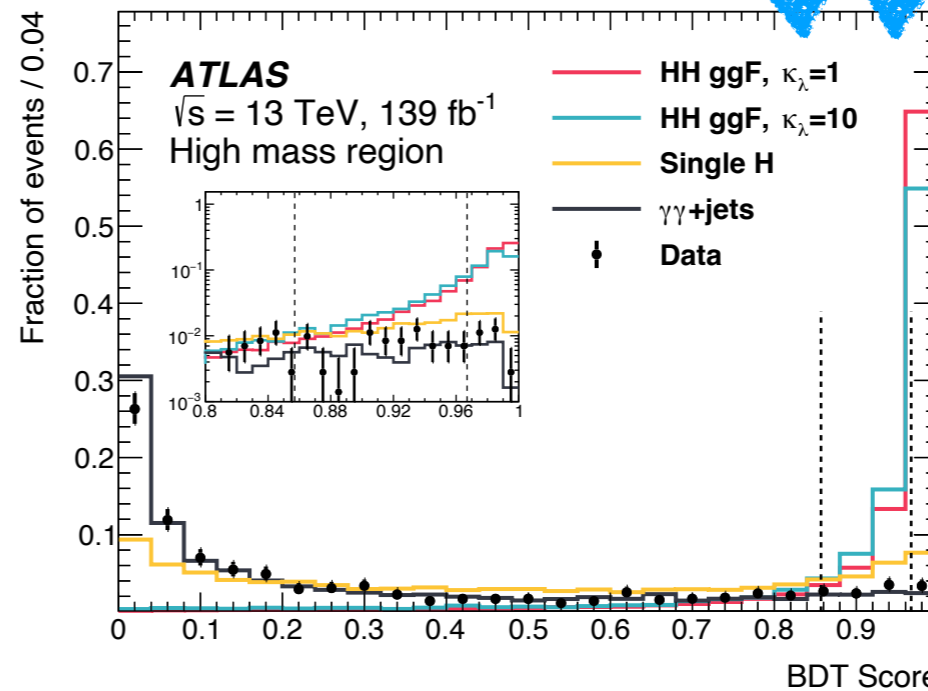
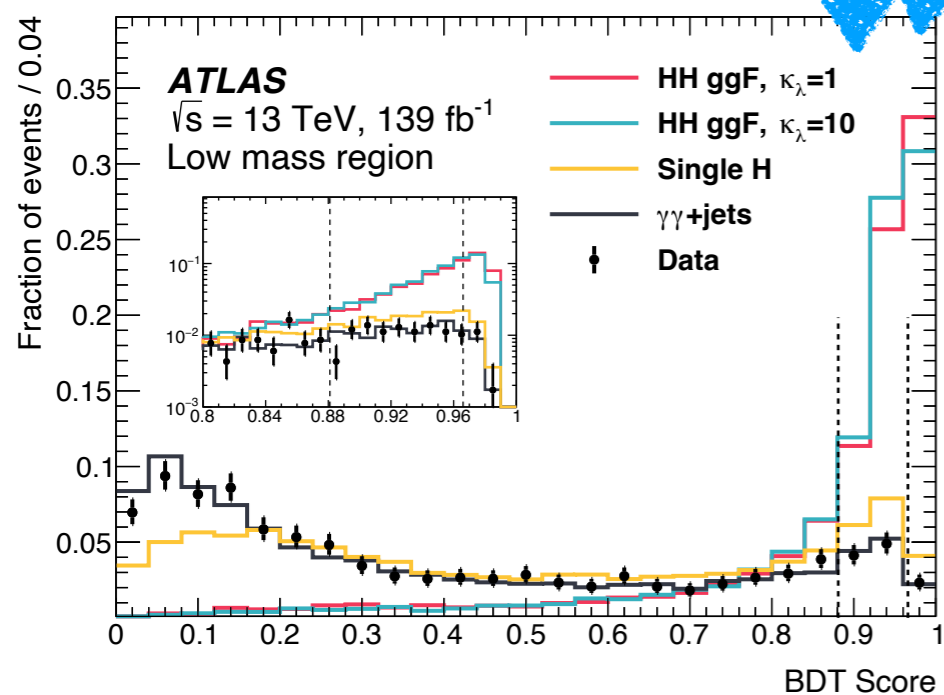

Fit $m_{\gamma\gamma}$ in 4 SR's simultaneously to extract signal

$b\bar{b}\gamma\gamma$ Background Estimate

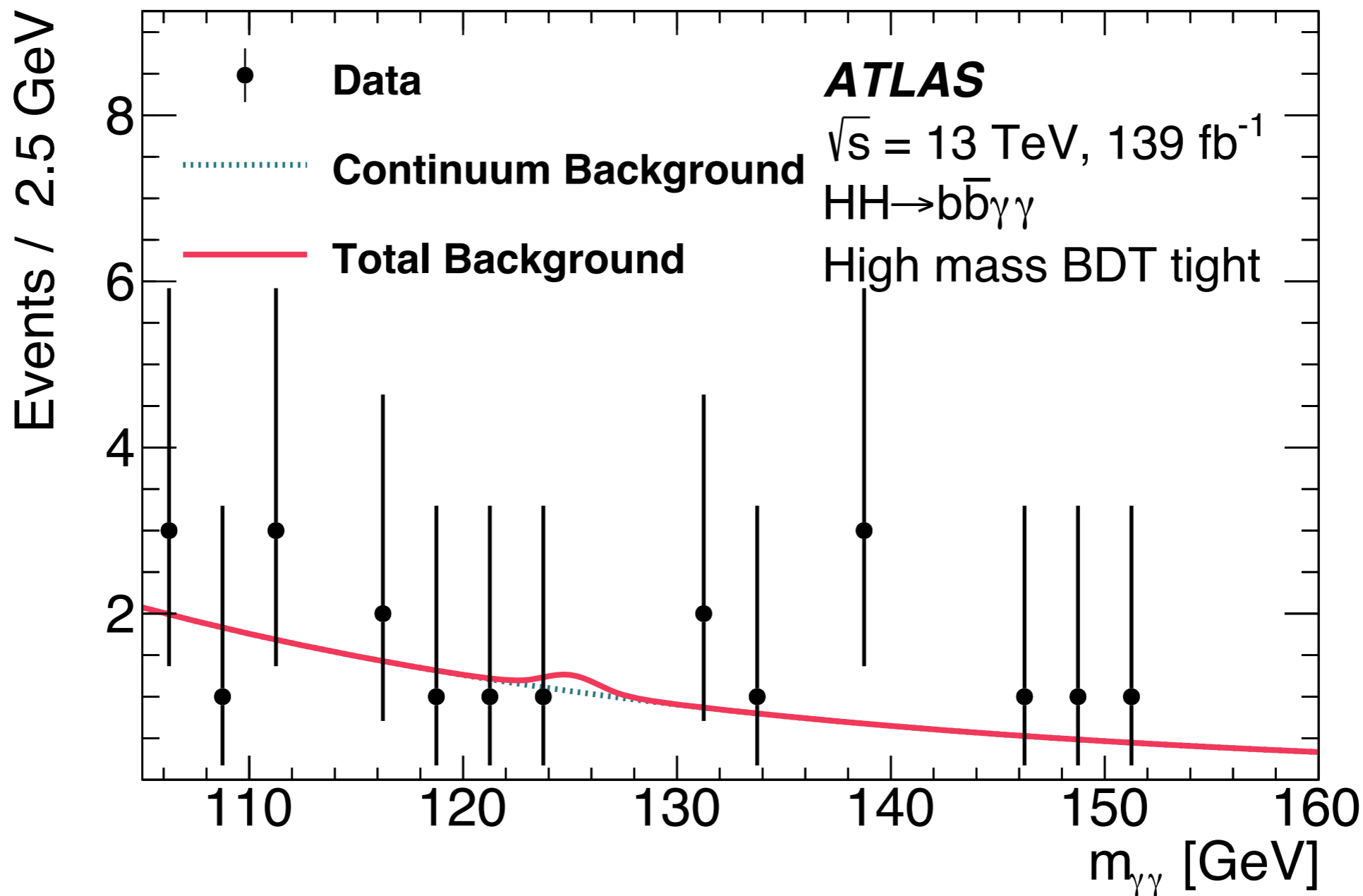
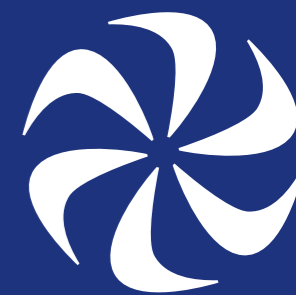

Background estimate formed on fit to $m_{\gamma\gamma}$ in different signal regions

Shape of background from MC, normalization determined from data

$b\bar{b}\gamma\gamma$ Results

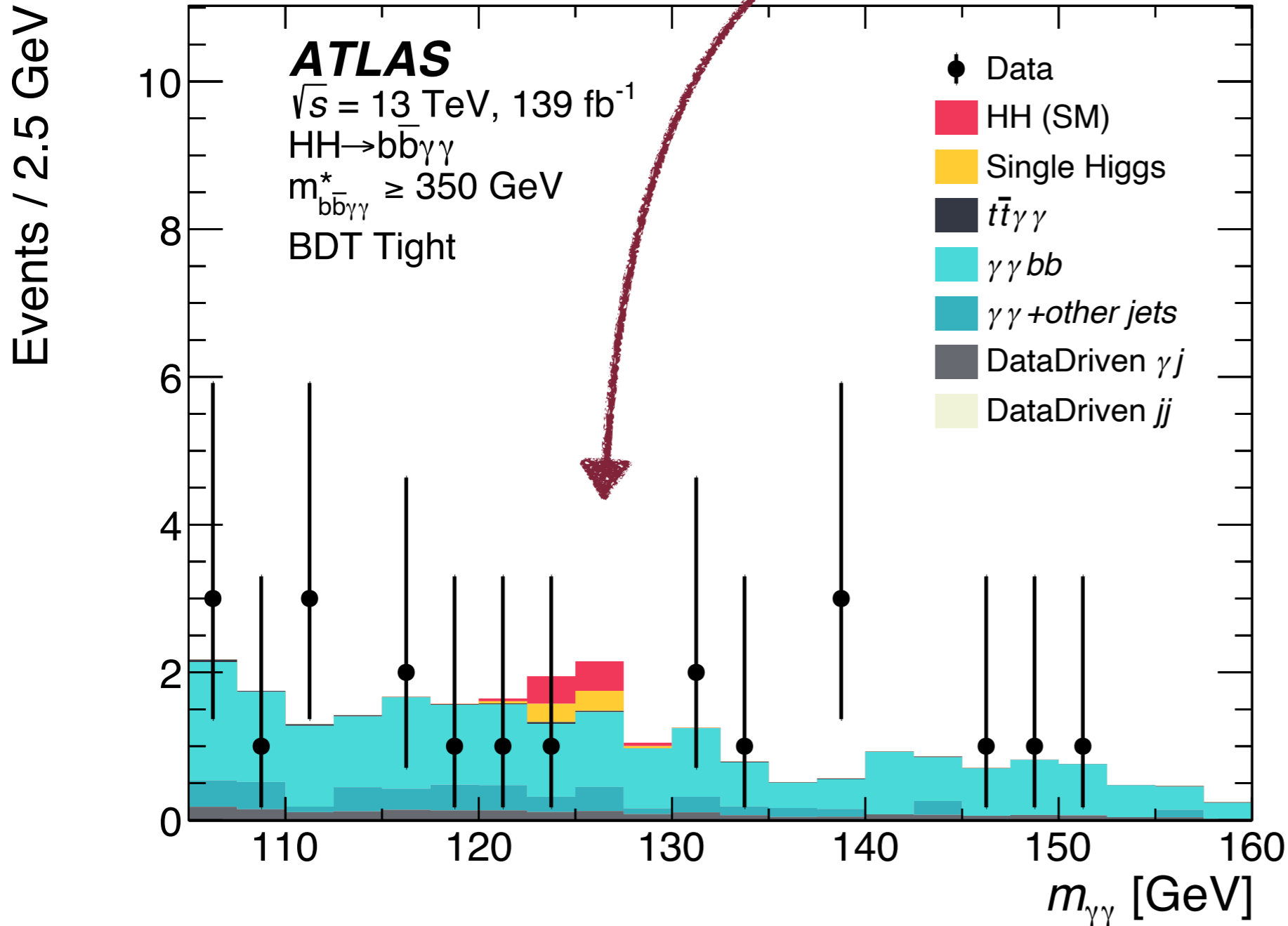

Look for a peak
in the $m_{\gamma\gamma}$ spectrum
near the Higgs

No obvious signs
of new physics

Similar results for
other signal
categories

$$HH \rightarrow b\bar{b}\tau\bar{\tau}$$

Separate into $\tau_h\tau_h$ and $\tau_\ell\tau_h$ channels

Trigger on di- τ , $\ell + \tau$,
or single ℓ

Require 1 or 2 'loose' τ :
 $m_{\tau\tau} > 60$ GeV

Balanced signature: τ_h allows for
good bkgd suppression

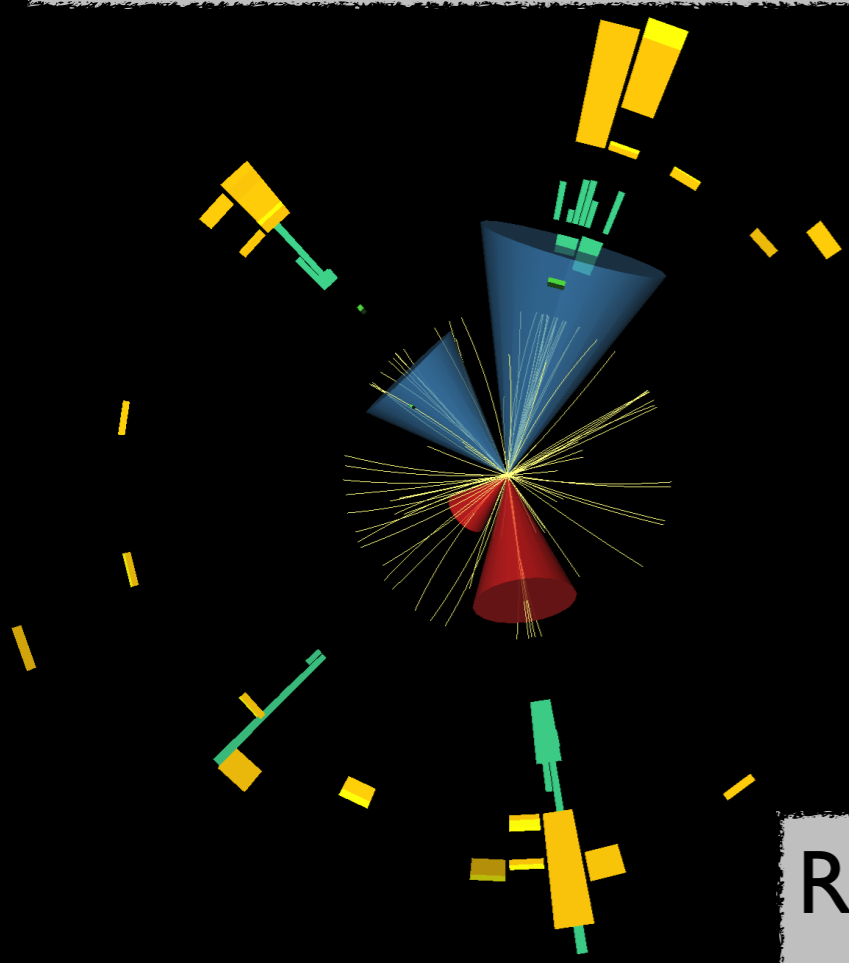

Require 2 b-tagged jets
($\epsilon = 77\%$)

arXiv:2209.10910

$b\bar{b}\tau\tau$ Background Estimate

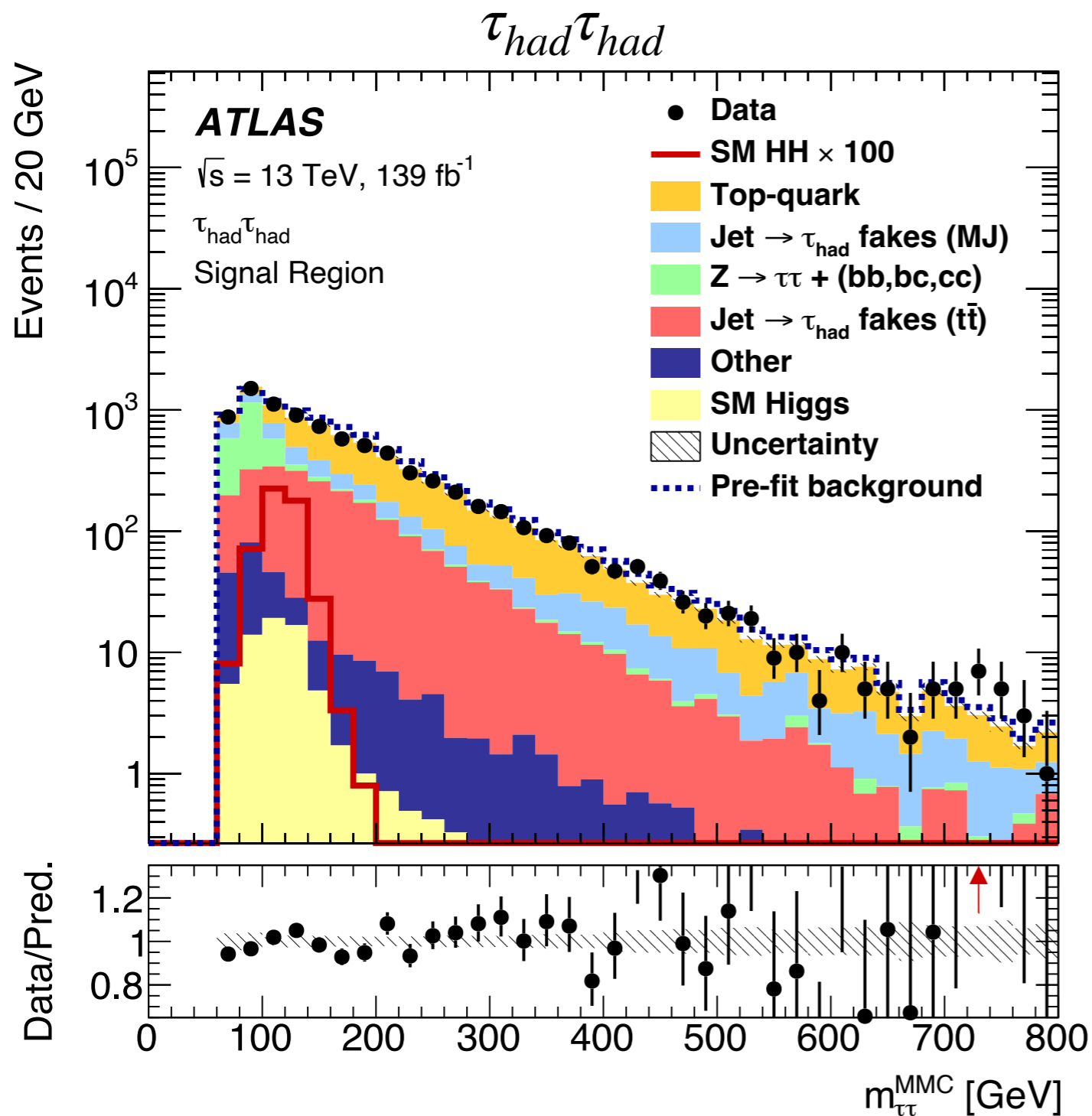
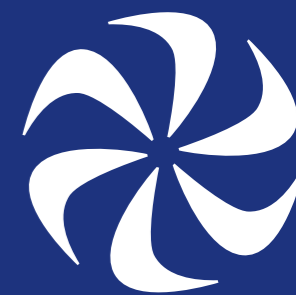

Top-quark background from MC, normalization floating in final fit

Z+jets background from MC, normalization from leptonic CR

Fake τ estimated from data using “fake factor” method

$b\bar{b}\tau\tau$ Strategy and Results

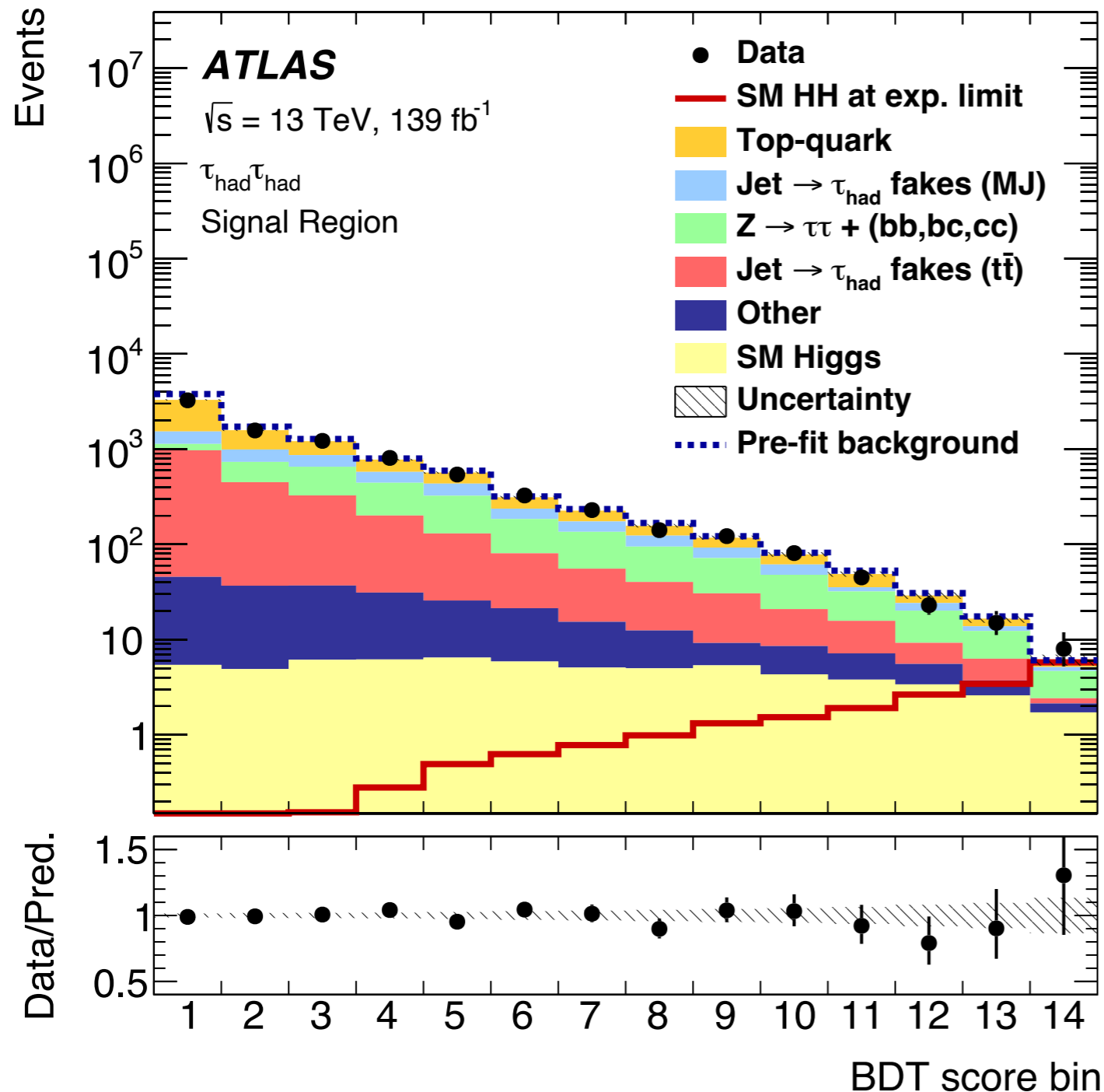

Fits to BDT/NN distribution used for final analysis

Data agrees well with background prediction

$\tau_{had}\tau_{had}$ has strongest sensitivity, but τ_{lep} channels also contribute

$$HH \rightarrow b\bar{b}b\bar{b}$$

Extremely challenging signature:
Large signal, but large backgrounds,
And difficult to simulate!

[arXiv:2301.03212](https://arxiv.org/abs/2301.03212)

Combination of 6 b-jet triggers

4 b-tagged jets
($\epsilon = 77\%$, $p_T > 40$ GeV)

Pair “closest jets” to form
Higgs candidates

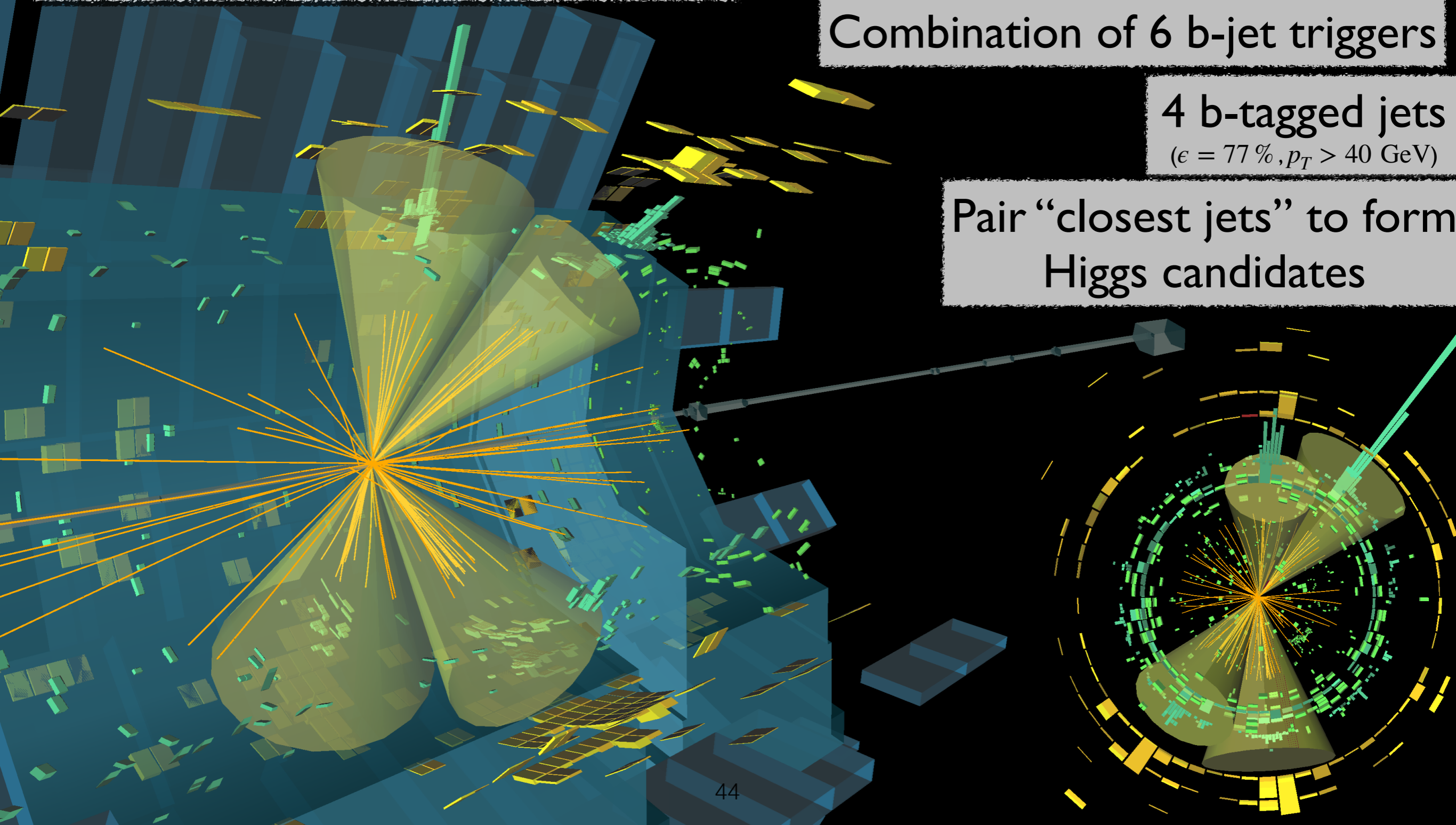

Triggering on b -jets

Eur. Phys. J. C 81 (2021) 1087



Multi-jet background rates are **huge**:

Utilize b -tagging in the trigger to manage the rates!

Fast b -tagging is enormously complicated: huge optimization game for speed and performance

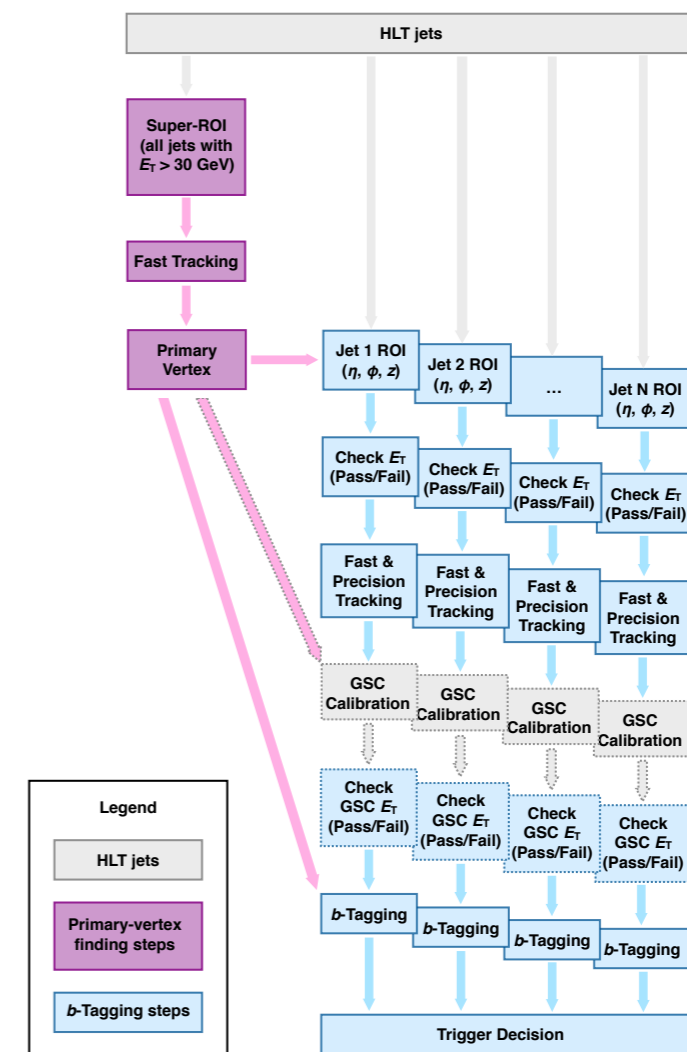
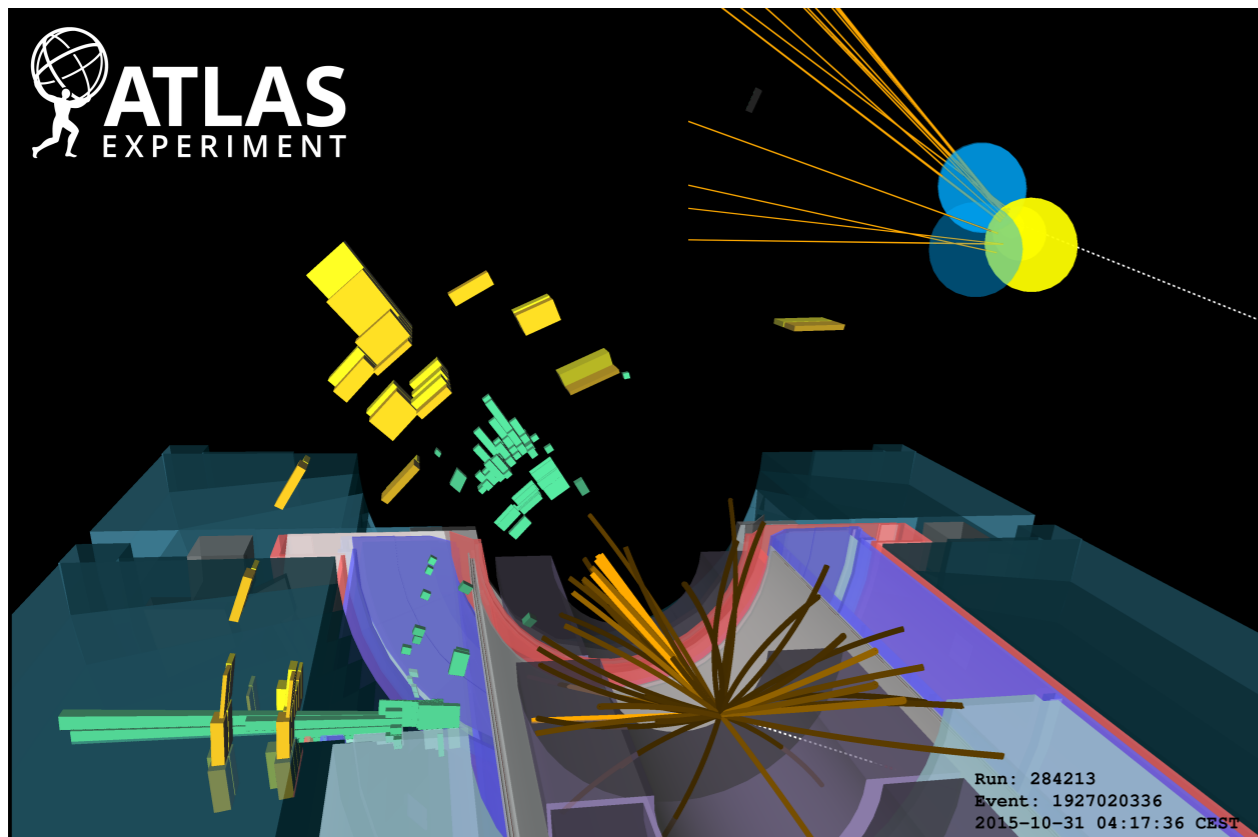

Enables efficient recording of 4 jets with $p_T > 45$ GeV,
and only 2 b -tags online

$b\bar{b}b\bar{b}$ Analysis Strategy

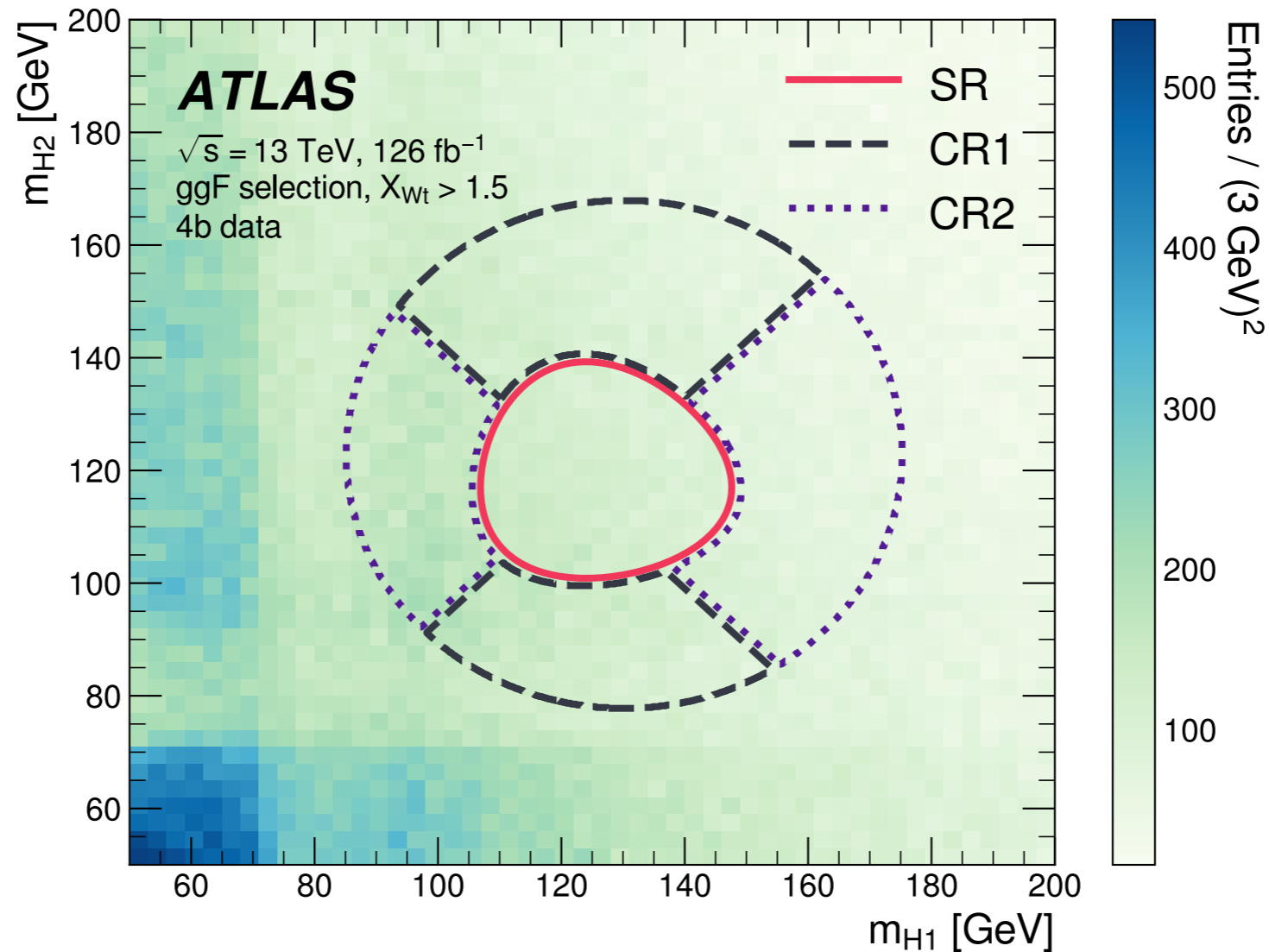

Reconstruct Higgs candidates, form “mass plane”

Center is signal-like; outer regions used for background and background validation

$b\bar{b}b\bar{b}$ Background

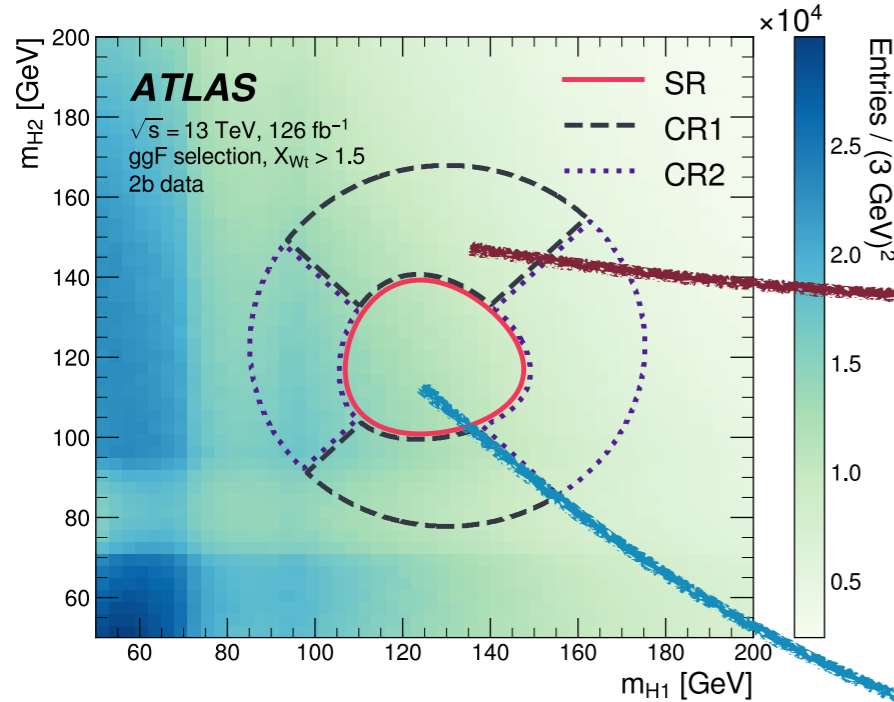

Step 0: form “mass planes” with leading/subleading Higgs, for 2b and 4b events

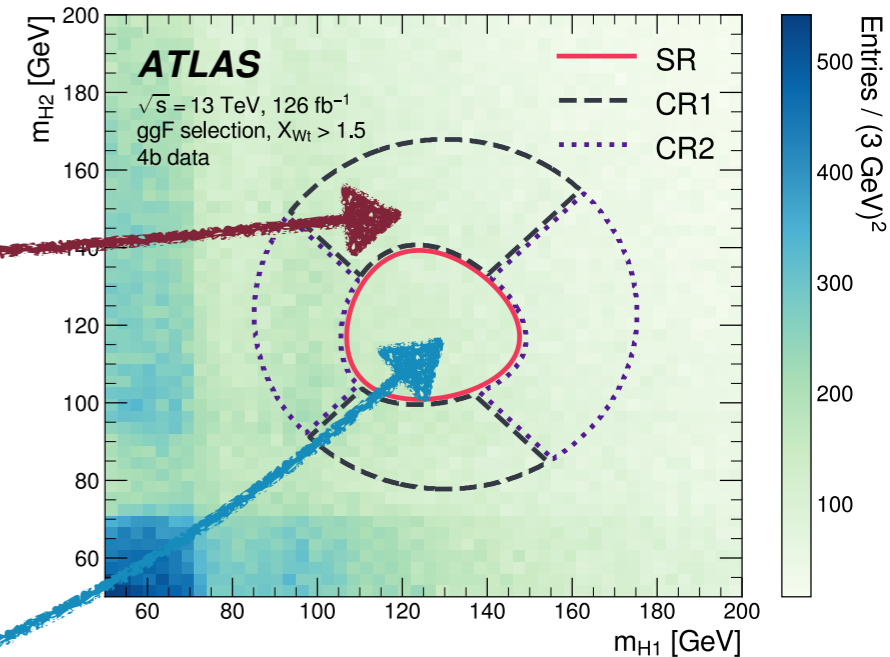

Step 1: use CR to train neural network to reweight data from 2b to 4b

Step 2: Apply this NN to 2b center: prediction for 4b SR

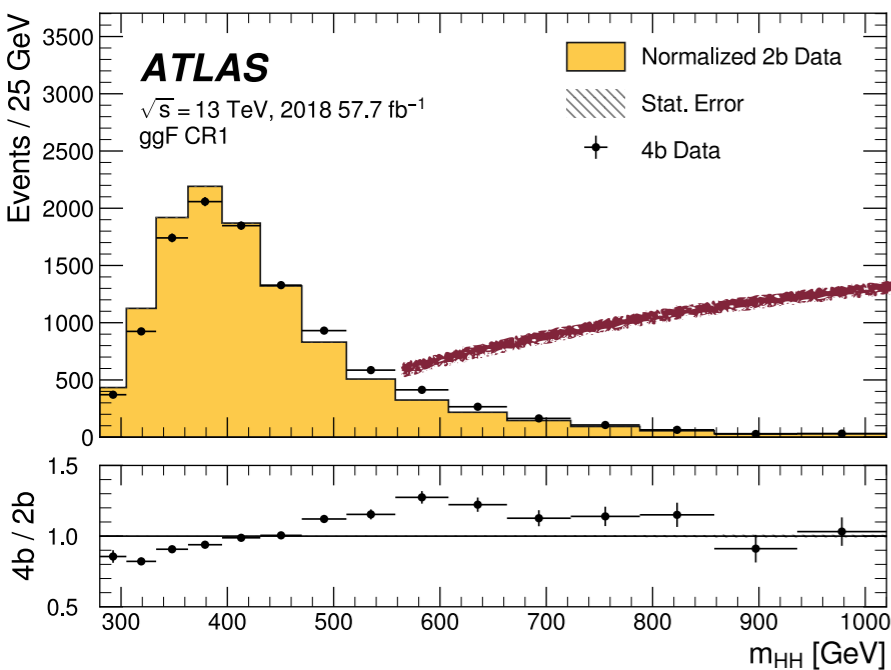

Orange histogram comes from 2b, black points from 4b

Neural network training

Systematics from alternate regions

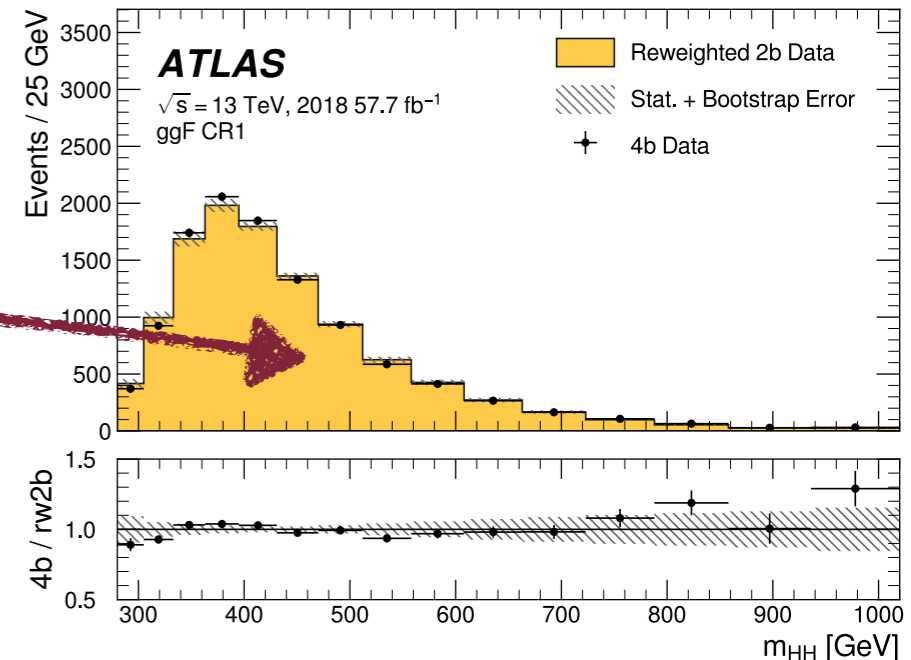

Systematic Uncertainties



Many usual types of uncertainties (alternate regions, etc.)

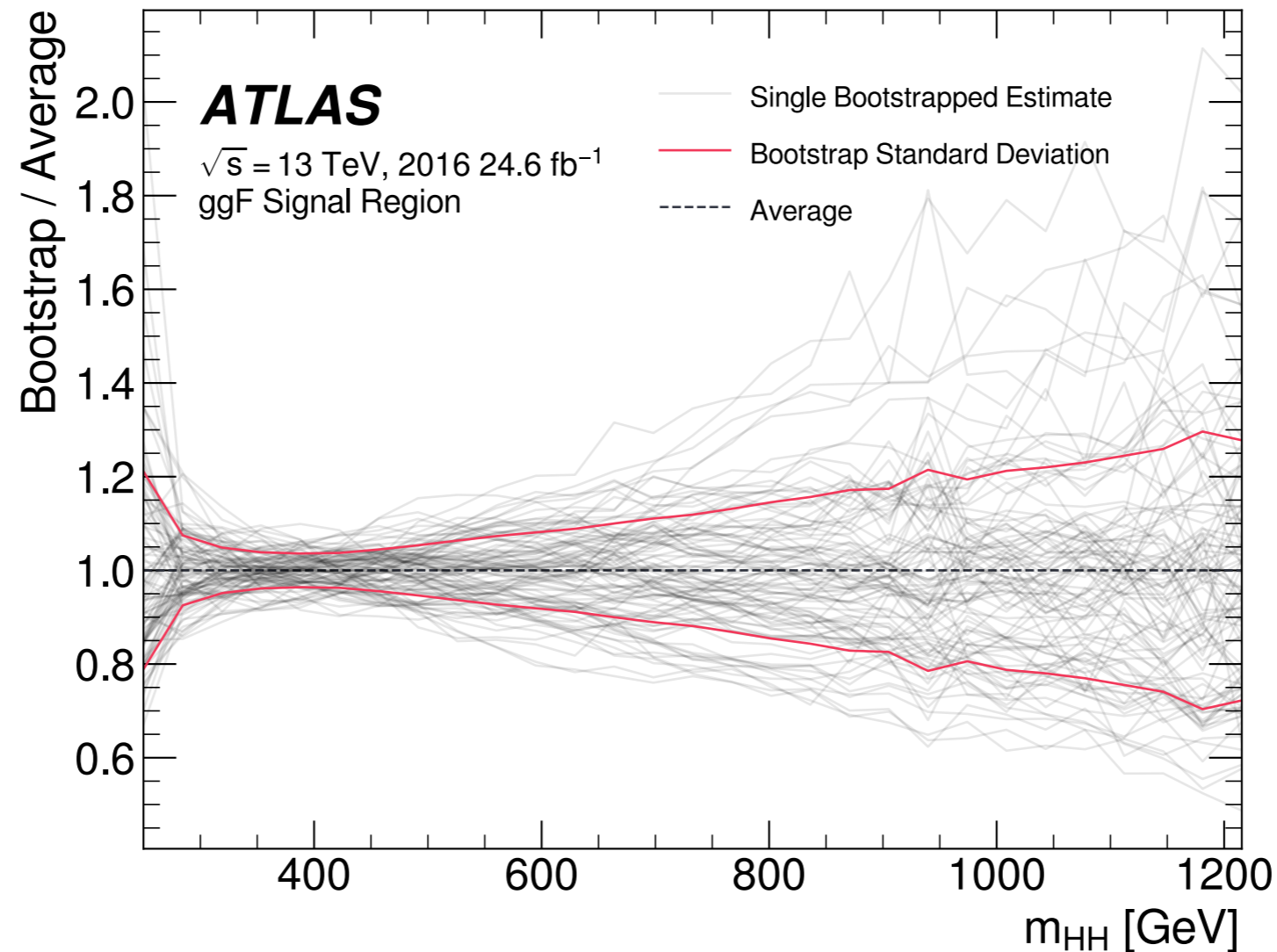

But *statistical* uncertainties play an important role as well:
bkgd estimate NN very sensitive to fluctuations in training

$b\bar{b}b\bar{b}$ Results

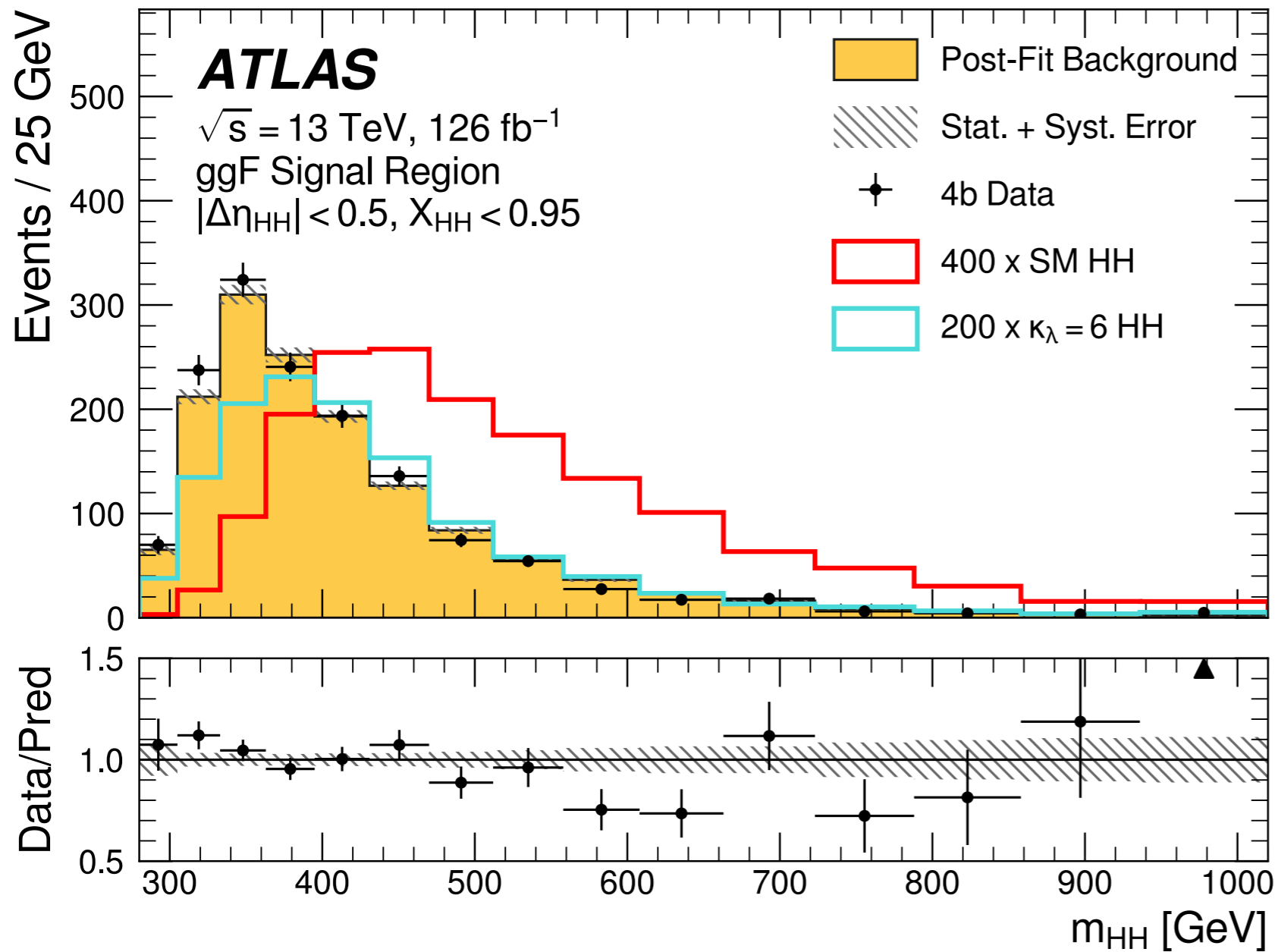

Large range of
signal regions defined

Cover various kinematic,
production regions

No excess observed

Combination

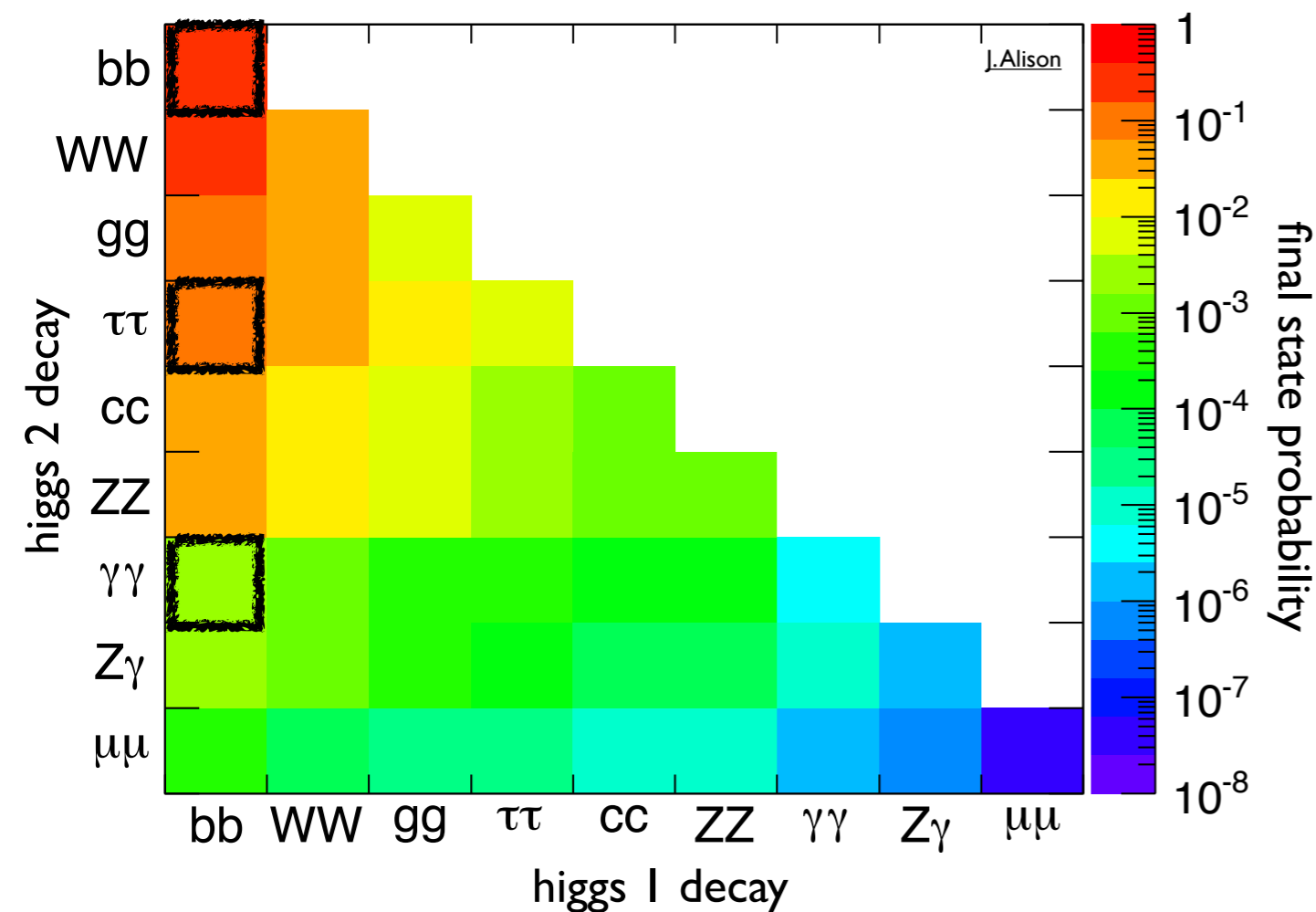

For optimal sensitivity:
combine all three analyses
into a single statistical
interpretation

No single analysis powerful
enough to measure these
processes on its own!

Limits on the SM

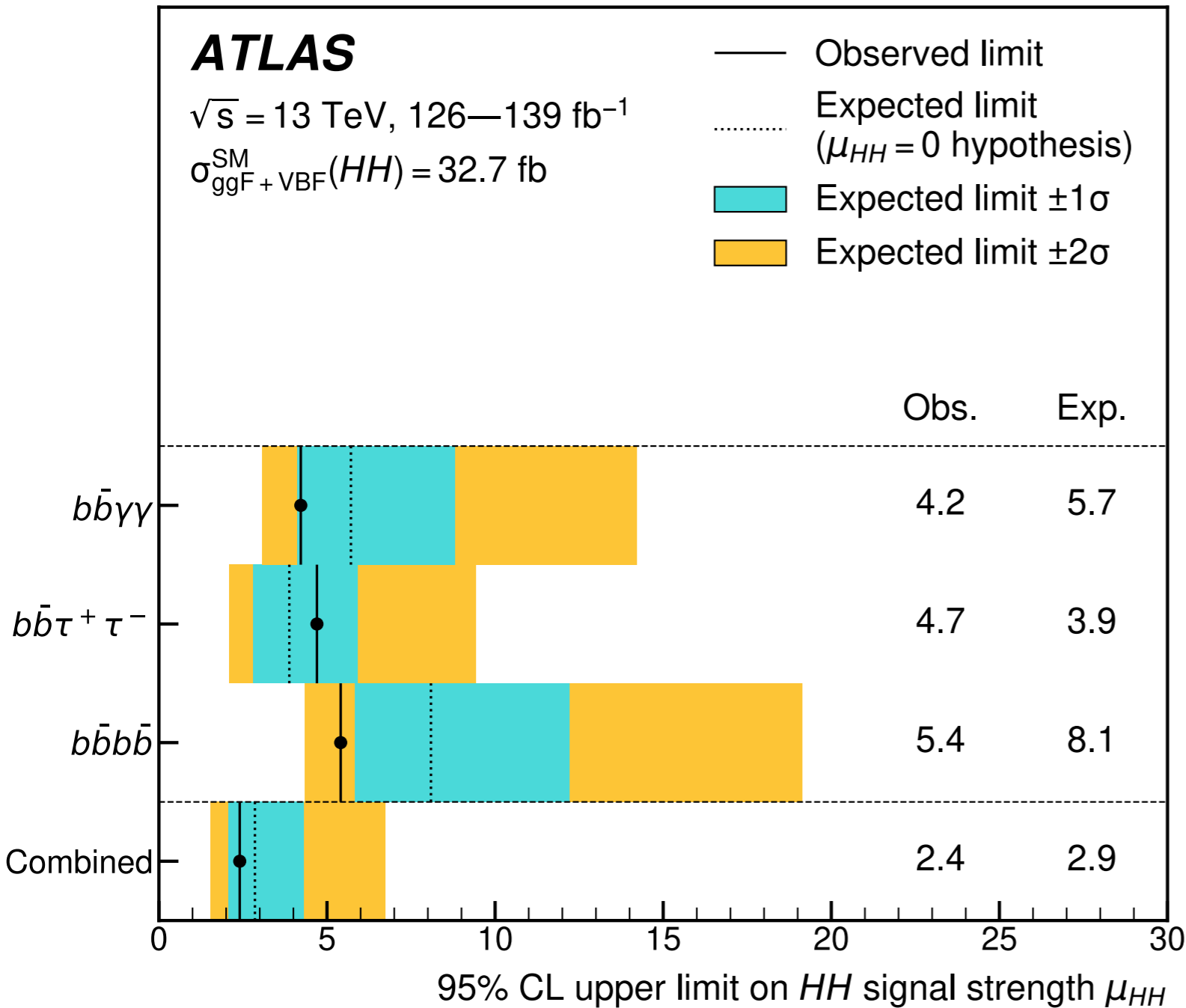

Let's put it all together:
 can we see HH?

Here, show “how many times
 larger the SM would have to
 be for us to be
 sure we didn't see it”

Individual analyses set
 limits at $\sim 4.5x$ SM

Together, set
limit at 2.4x SM

arXiv:2211.01216

Measuring the Potential

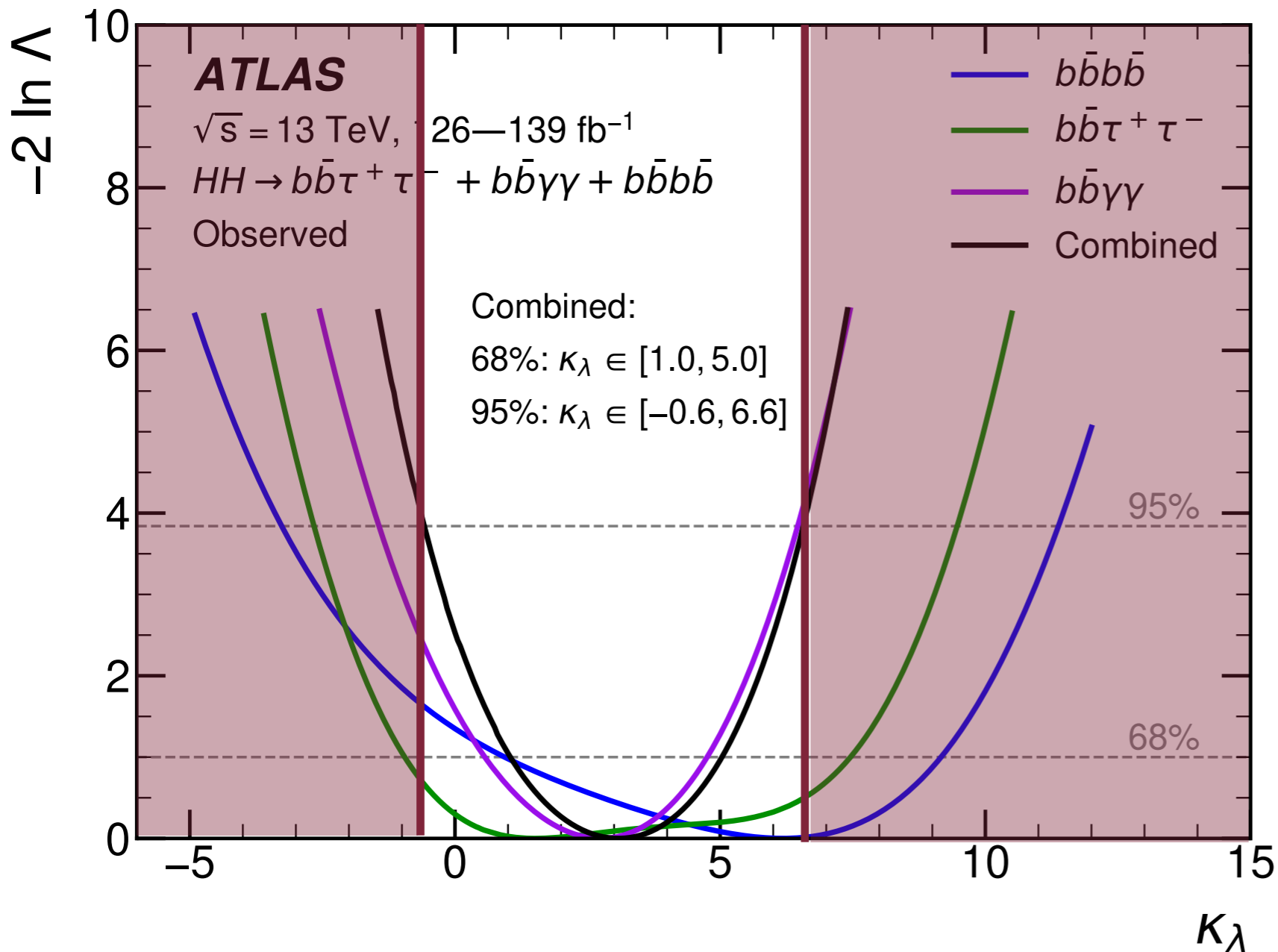

Here, show *likelihood* vs κ_λ

Minimum here is the
“best fit”

95% C.L. range
is the “limit”

Each of the three
analyses contributes
to the combination

$-0.6 \leq \kappa_\lambda < 6.6$ is
the allowed range:
starting to probe EWBG!

Beyond κ_λ



Focused discussion on κ_λ , but a whole host of additional BSM physics is accessible

Critical to understand degeneracies with κ_λ : are we actually measuring the Higgs potential, or other BSM?

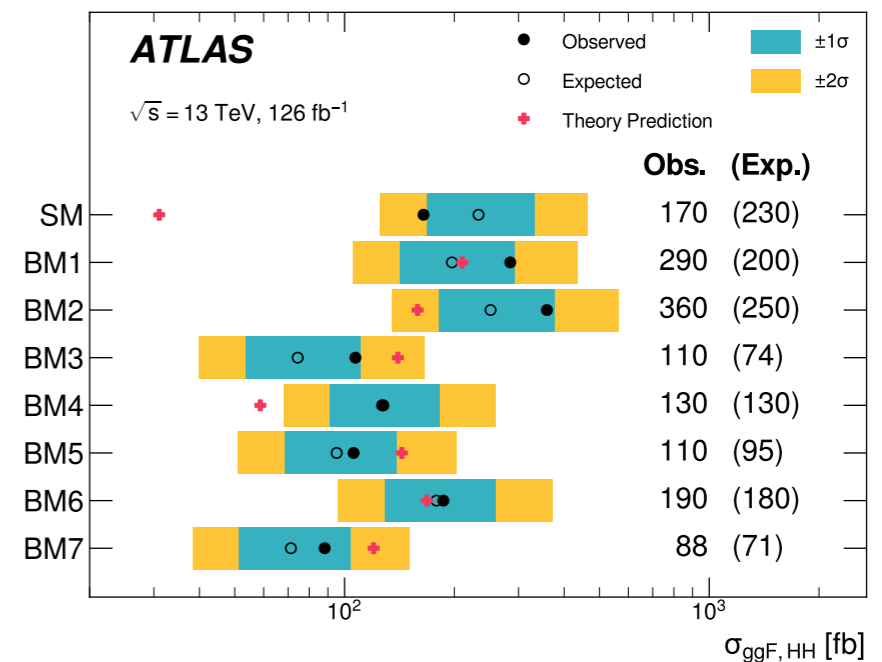
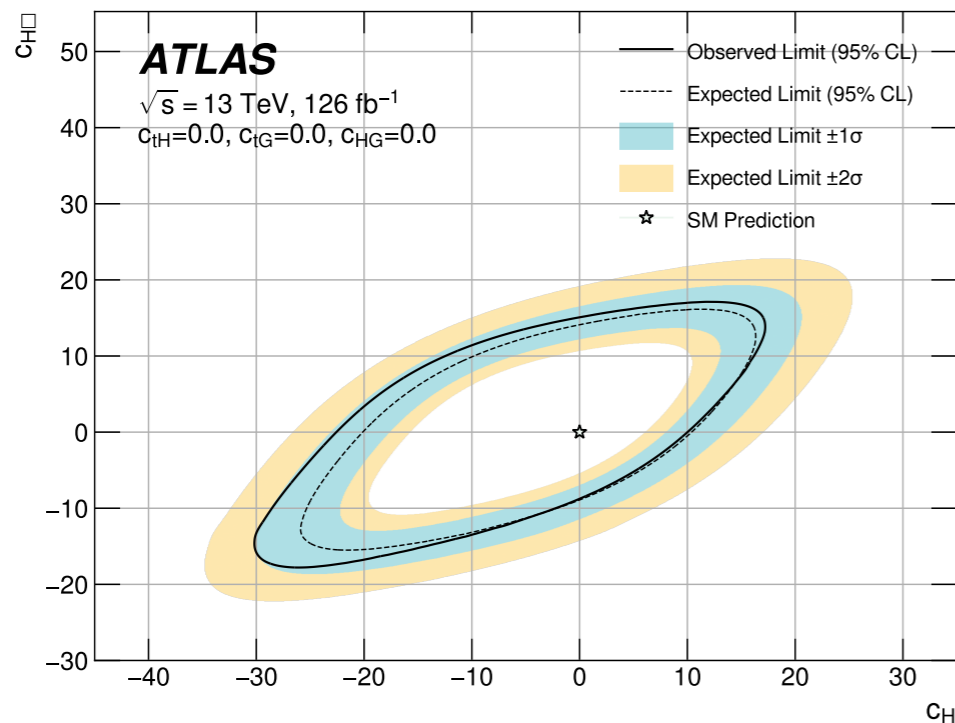
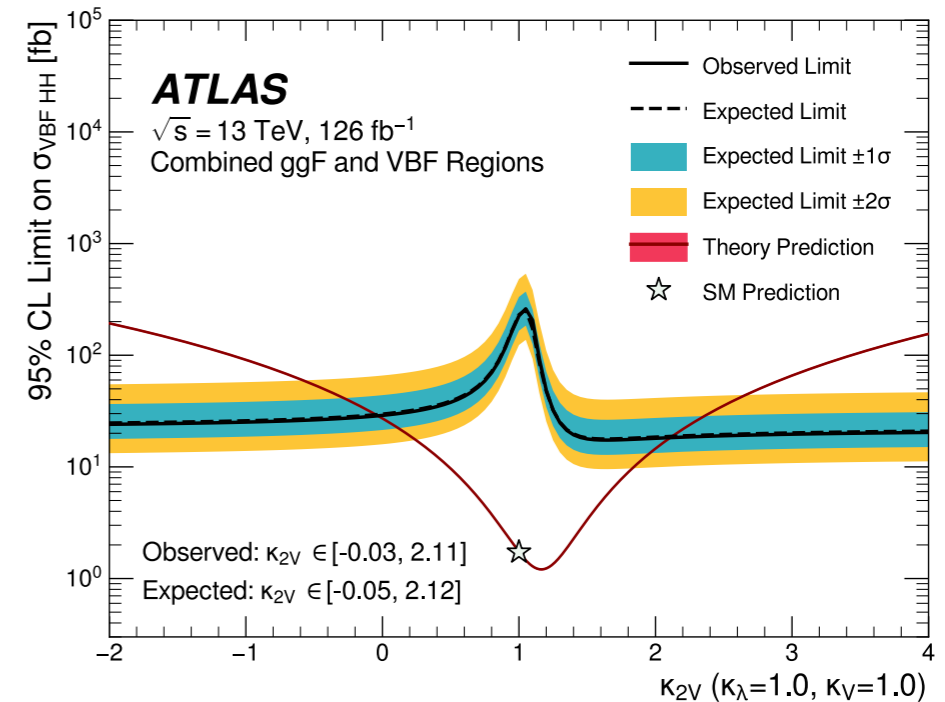

The LHC Context

What Do We
Look For?

The Next Frontier:
Higgs Pairs

Outlook

What Now?



Analysis of run2 data isn't even complete!

With additional channels, can push limit to $\sim 2x$ SM

No golden channel: need as much signal as possible

And combination with CMS data will get us even better!

More data from Run3 will bring us tantalizingly close to evidence of HH

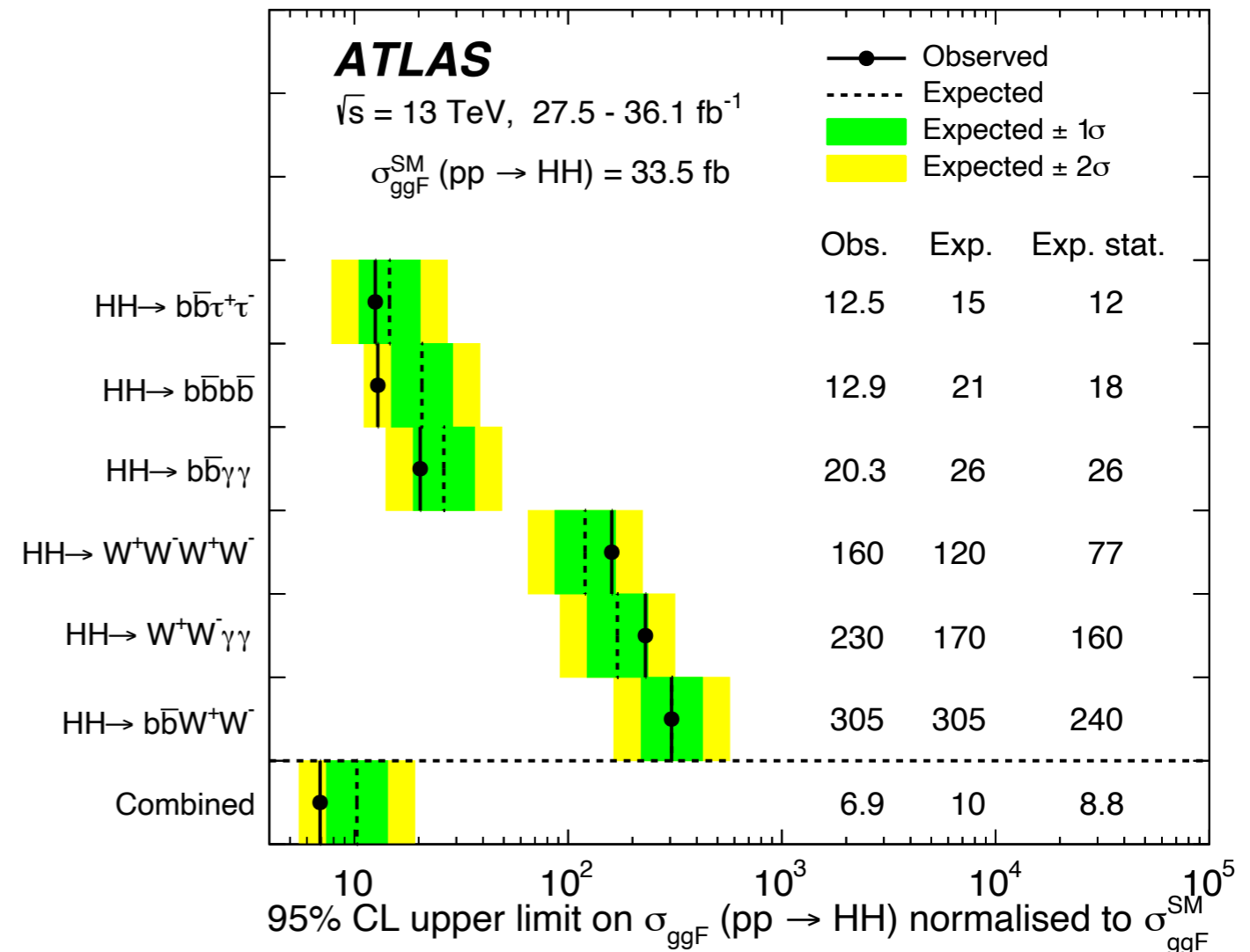

What's Coming in Run3



FTAG-2023-01

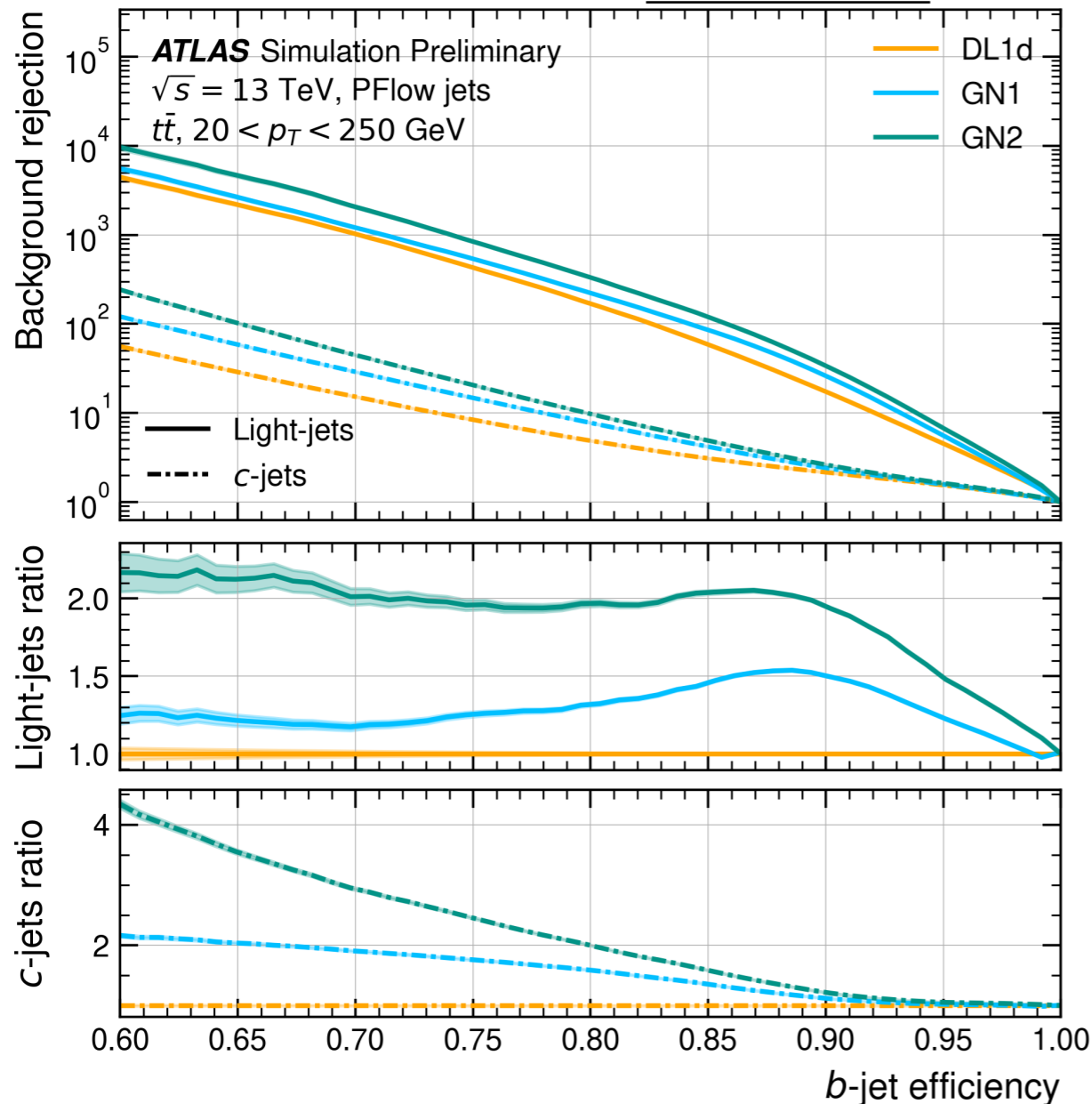

DL1r was ATLAS's run2 tagger: outperformed BDT's by a factor of 2

Now, GNN-based algorithms outperform DL1r(d) by **another factor of 2!**

4x less background per b-jet, with just algorithmic improvements!

And we can run it in the trigger, too!

What's Coming in Run3

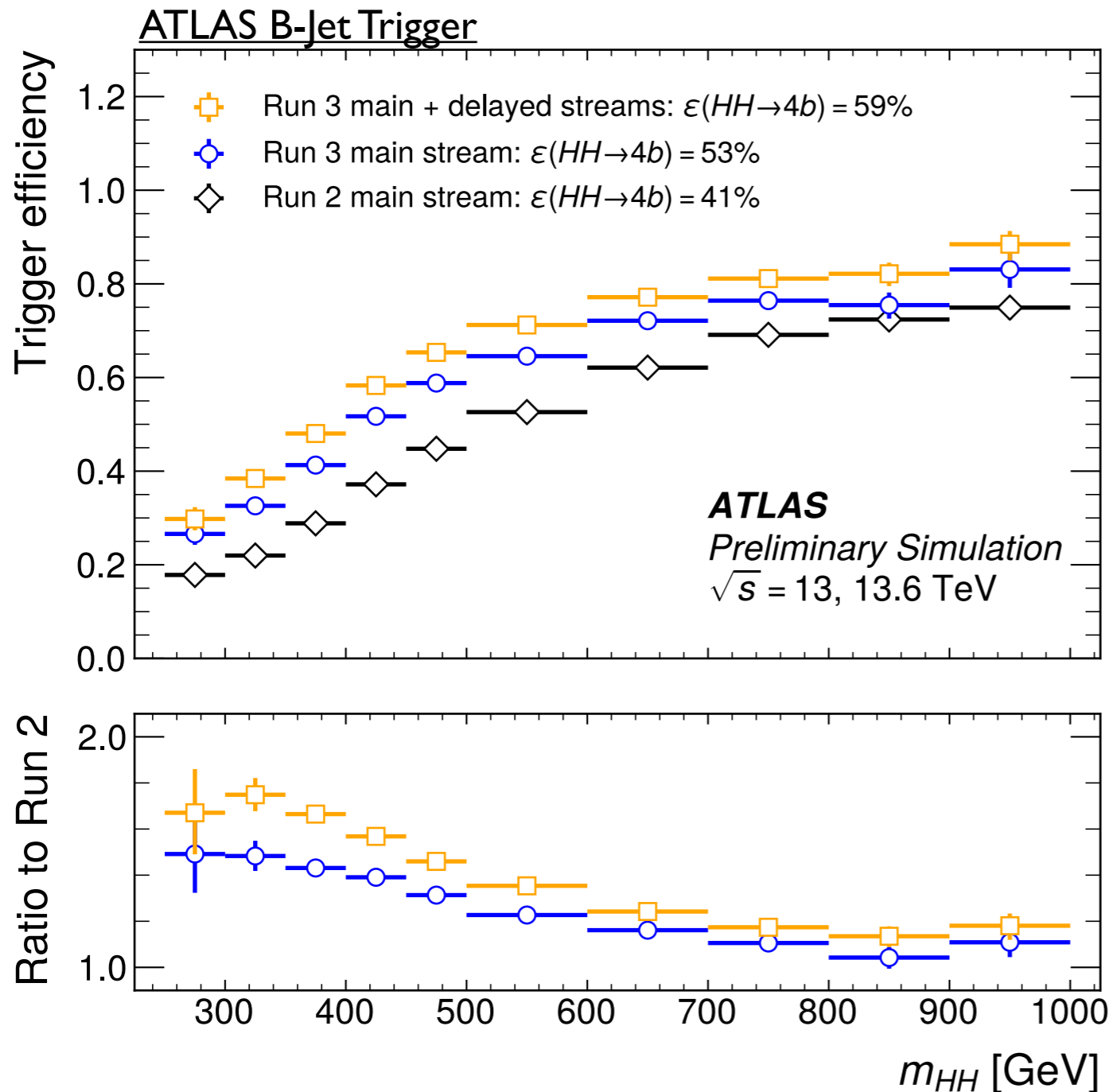

Triggers have also been re-optimized, especially for $b\bar{b}b\bar{b}$ and $bb\tau\tau$

Improved b -tagging, jet reconstruction, calibration, p_T selections, bandwidth

Nearly 100% more signal at low m_{hh} for $b\bar{b}b\bar{b}$ final state!

The HL-LHC



Huge upgrades on the way to collider and detectors to take data even faster

Measurements are statistically limited: more data is critical!

Projections to the full dataset show κ_λ sensitivity to 50%

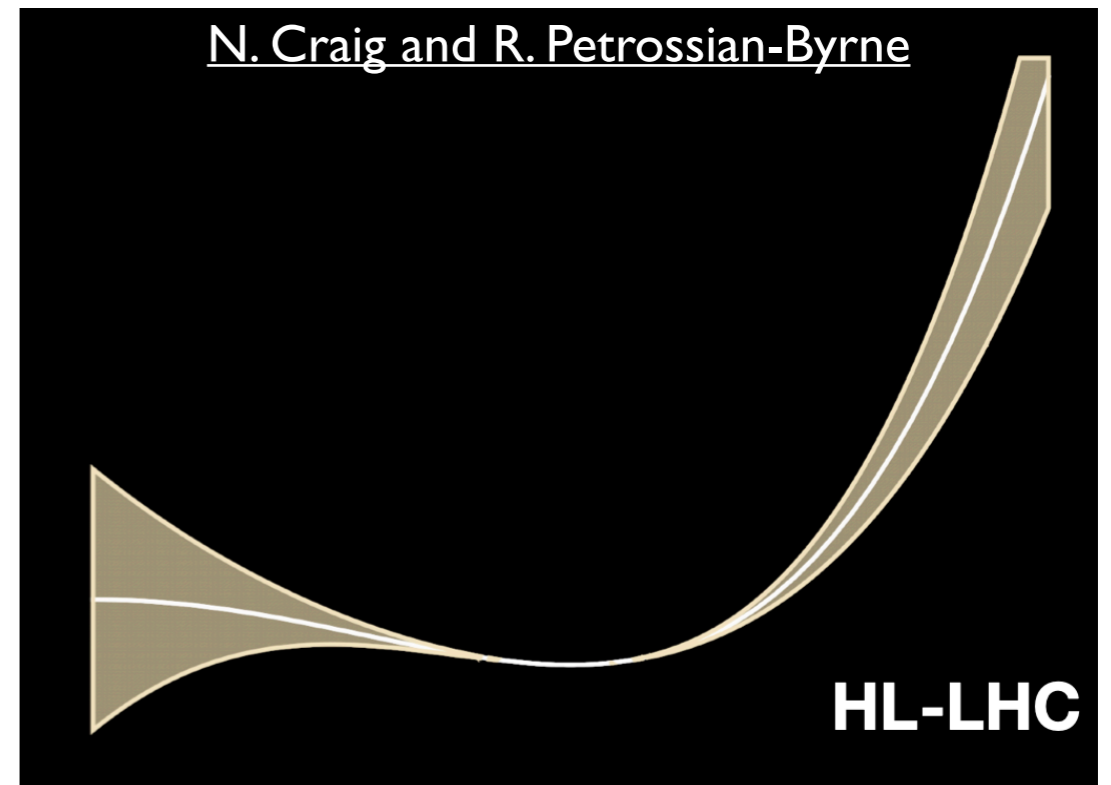
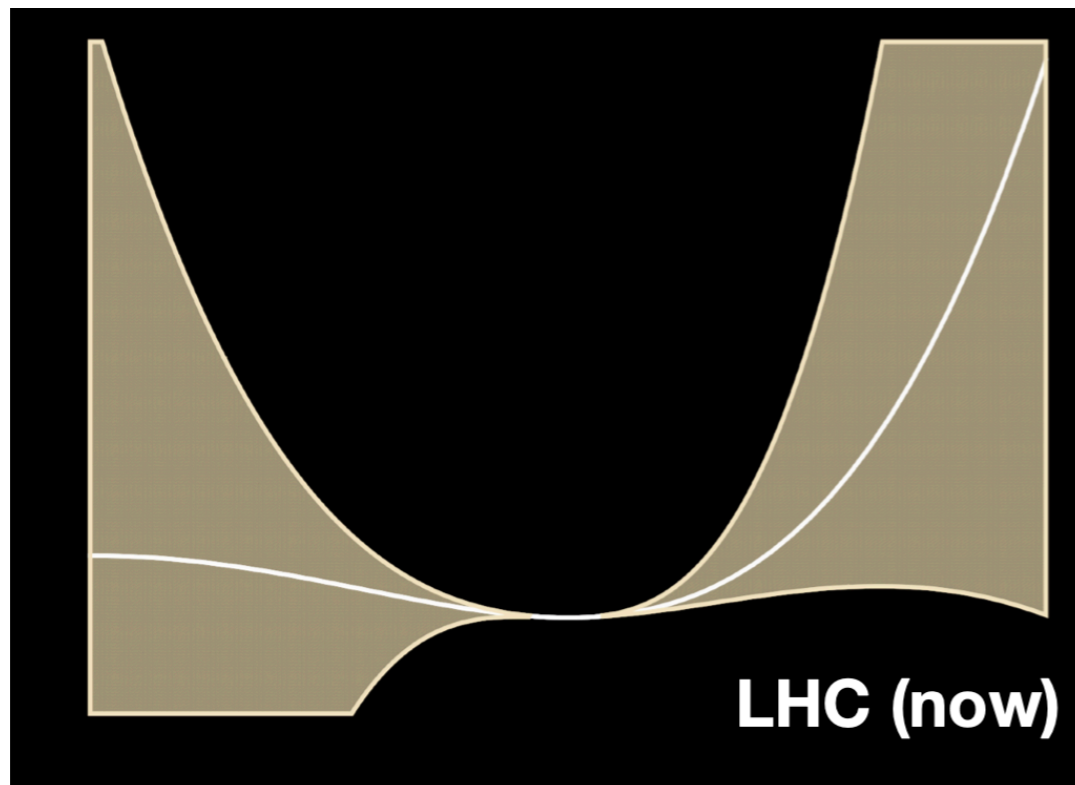
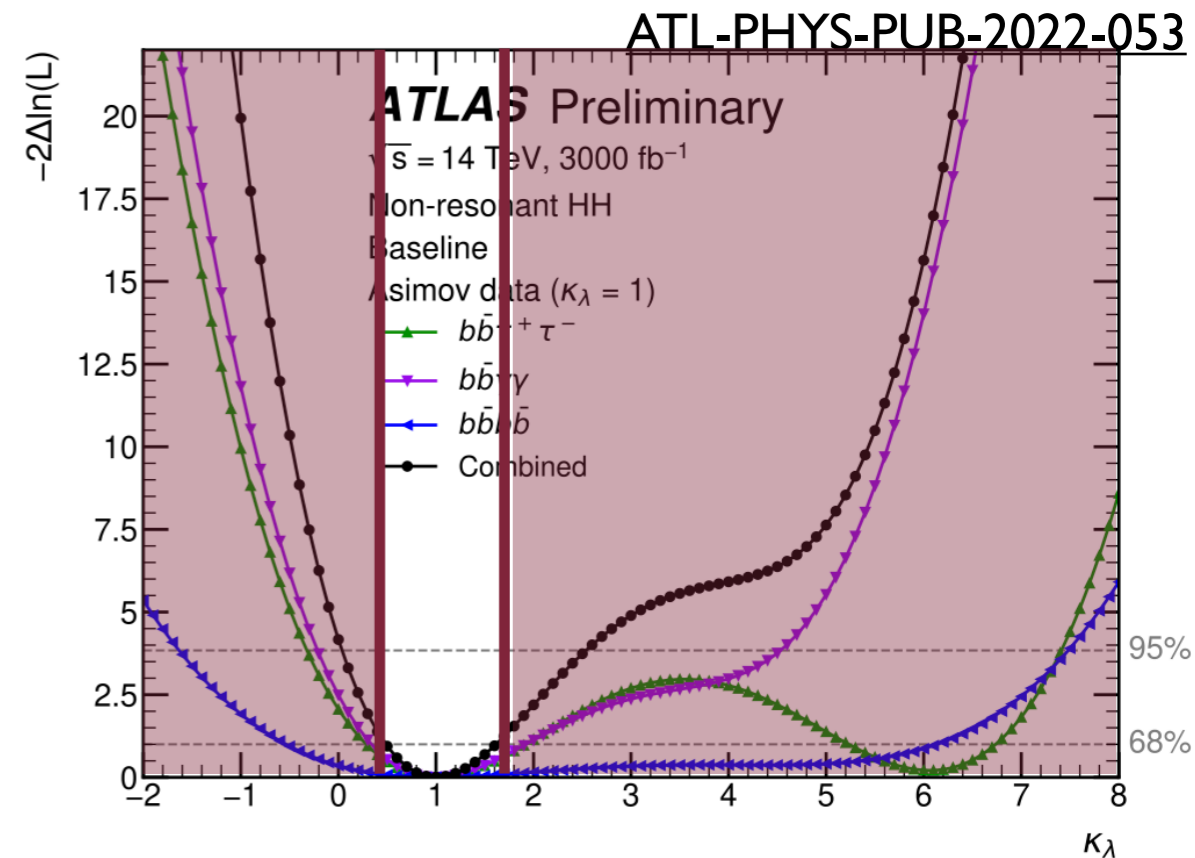

Beyond the HL-LHC?



<10 % precision is the holy grail:
Essentially discover or rule out EWSB

Need higher energy machines!

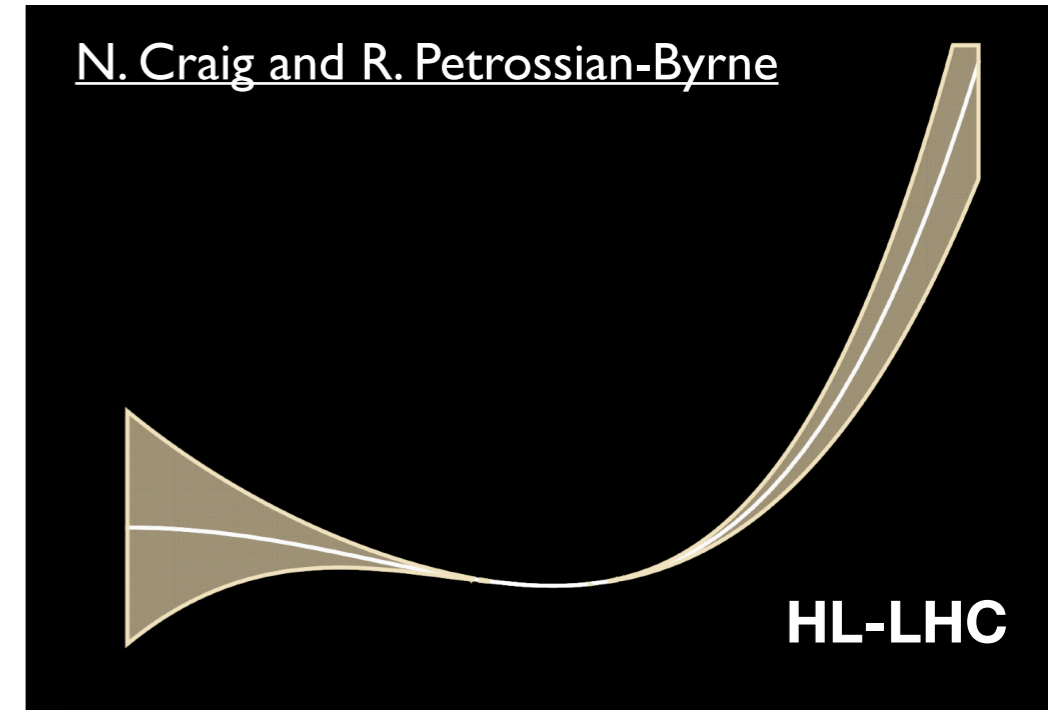
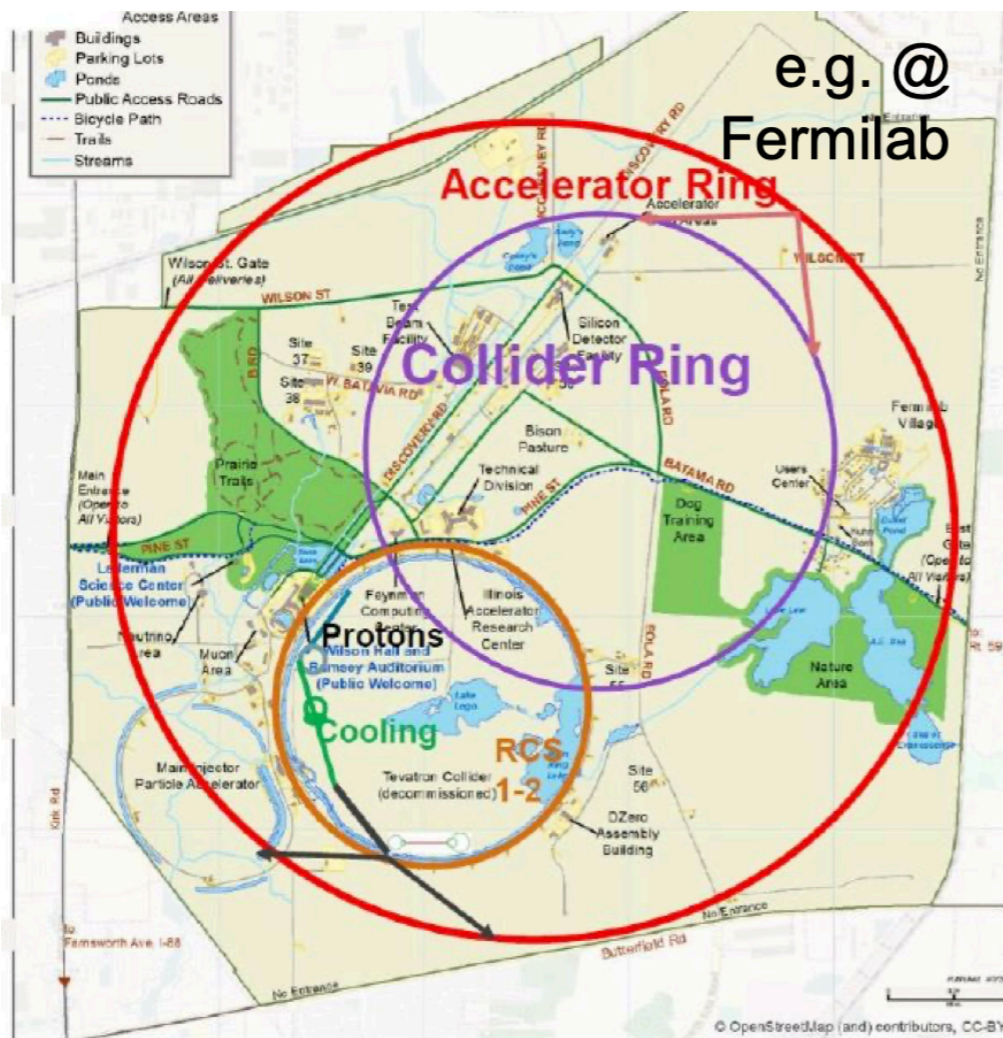

A μ Collider at FNAL could do **~5%**

The Higgs is the center of the SM:
Measuring its potential is the
next frontier at the LHC

The rare signature takes advantage of
the **huge LHC datasets**

Measuring the Higgs potential
can help answer where the universe's
anti-matter has disappeared
via **electroweak baryogenesis**,
and can give clues to vacuum stability

Our experimental program at ATLAS
is working to overcome the challenges
of the signature, to discover Higgs pair
production, and to **measure the
Higgs potential**

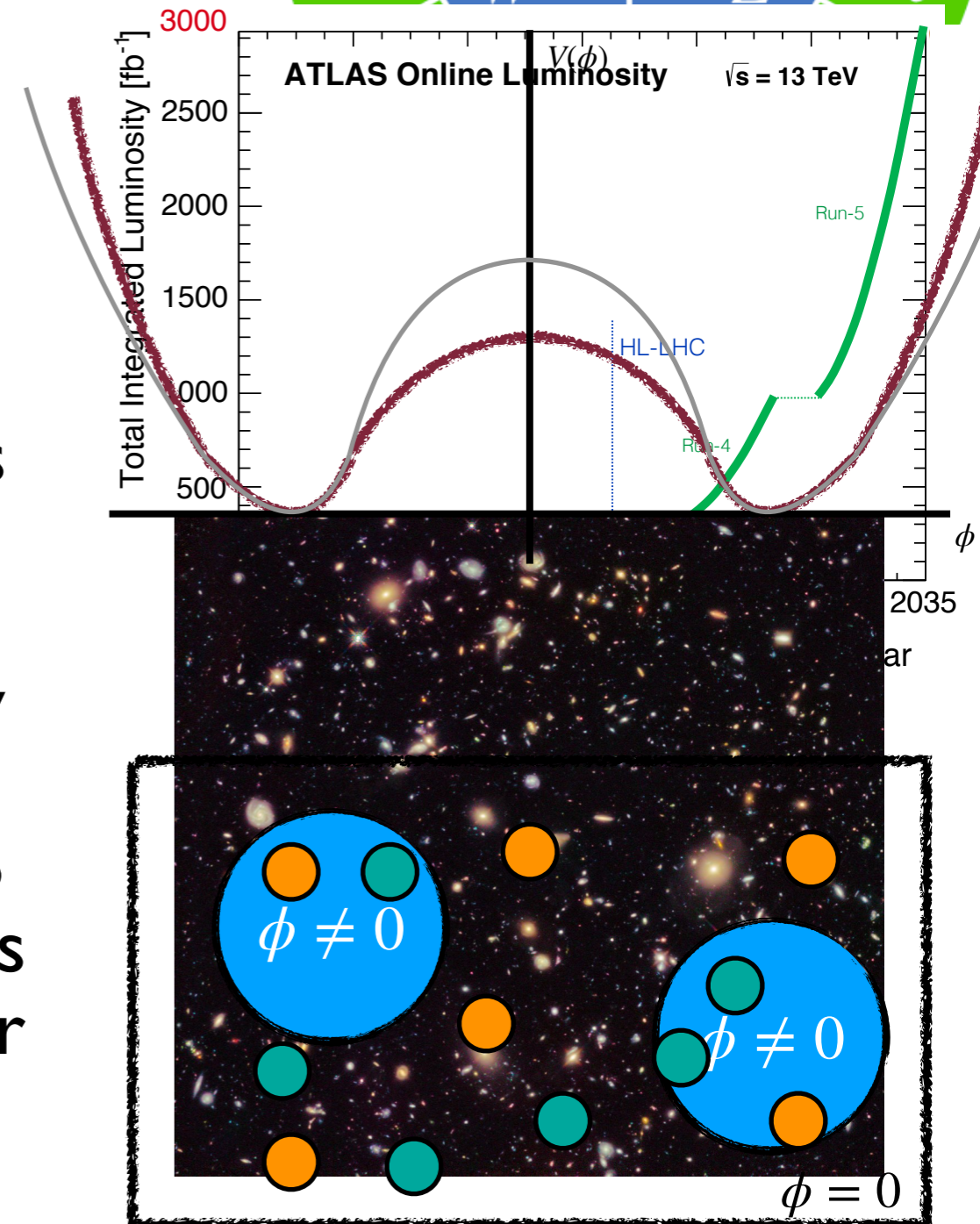
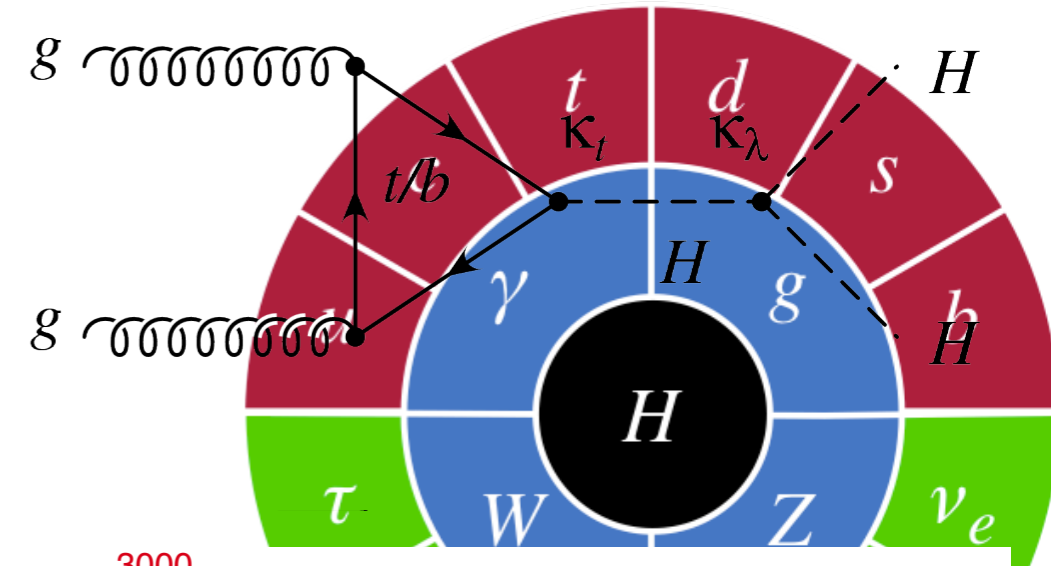

Thank you!

More in:

[Phys. Rev. D 106 \(2022\) 052001](#)

[arXiv:2209.10910](#)

[arXiv:2301.03212](#)

[arXiv:2211.01216](#)

Backup

b -Tagging

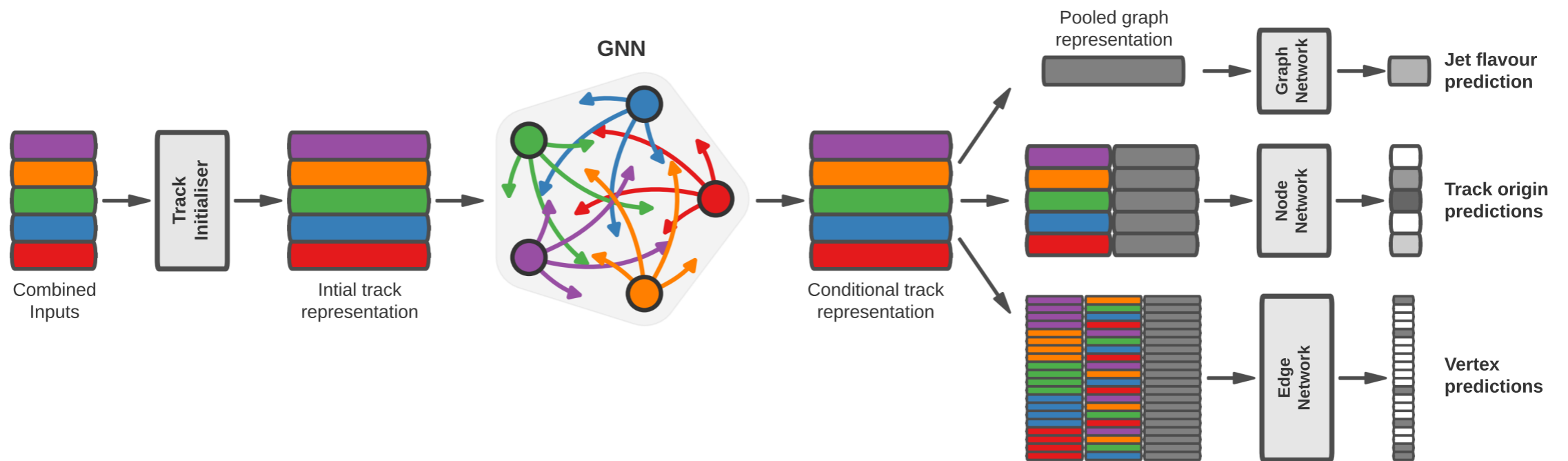
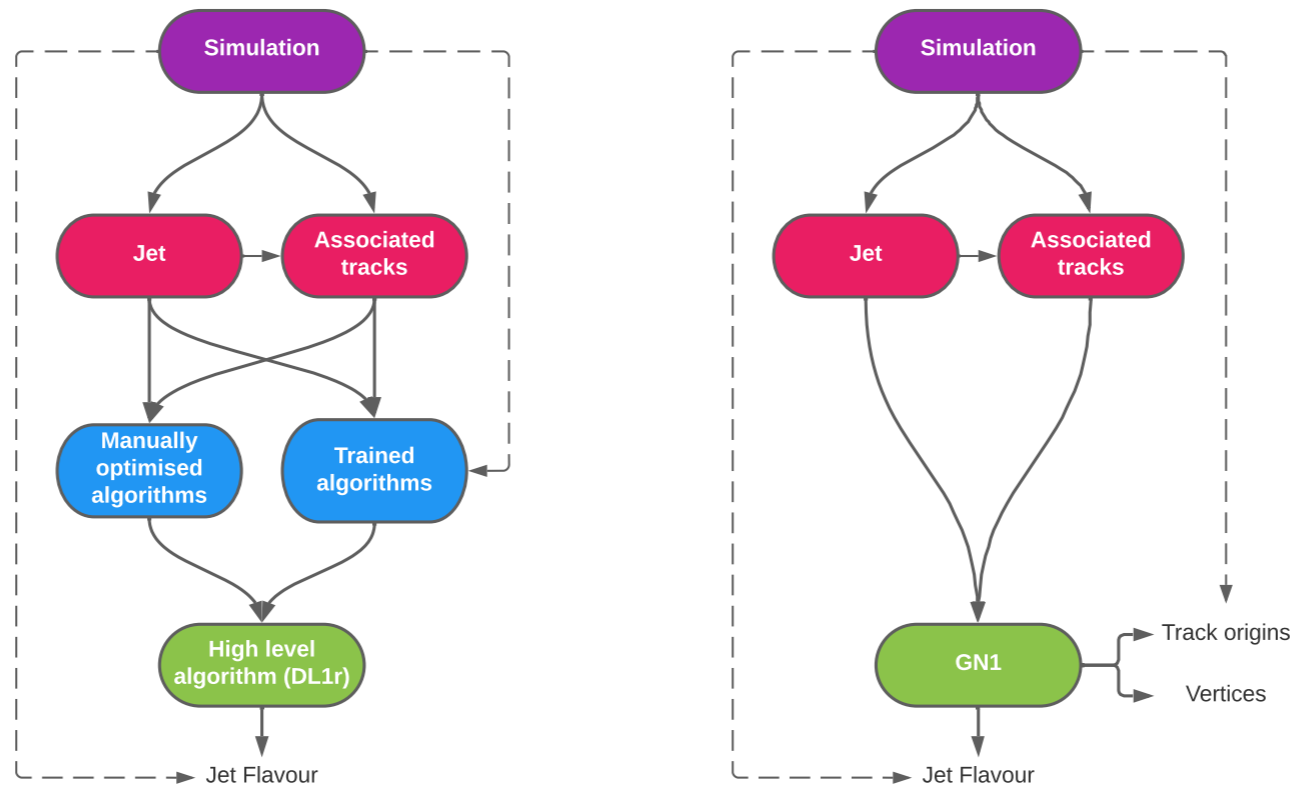

4b Analysis Flow

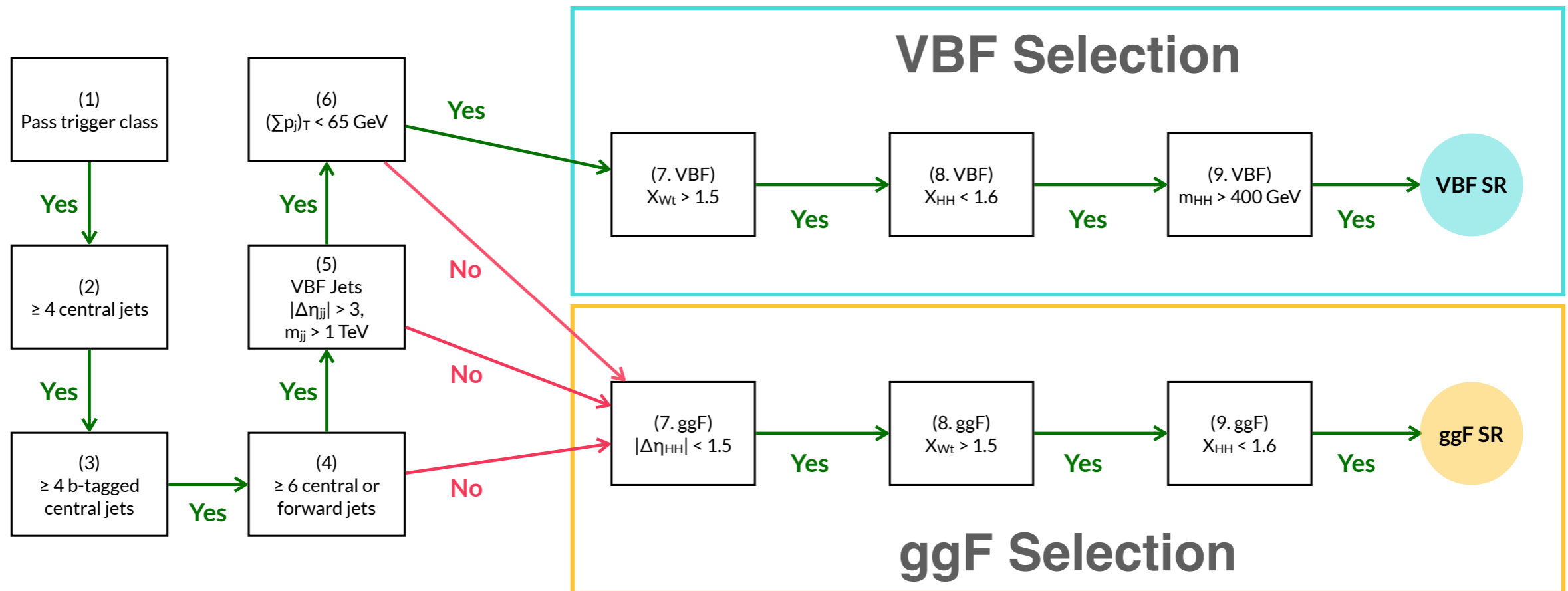

Resonant Searches



If we want to see BSM effects in the potential,
can also look for BSM directly

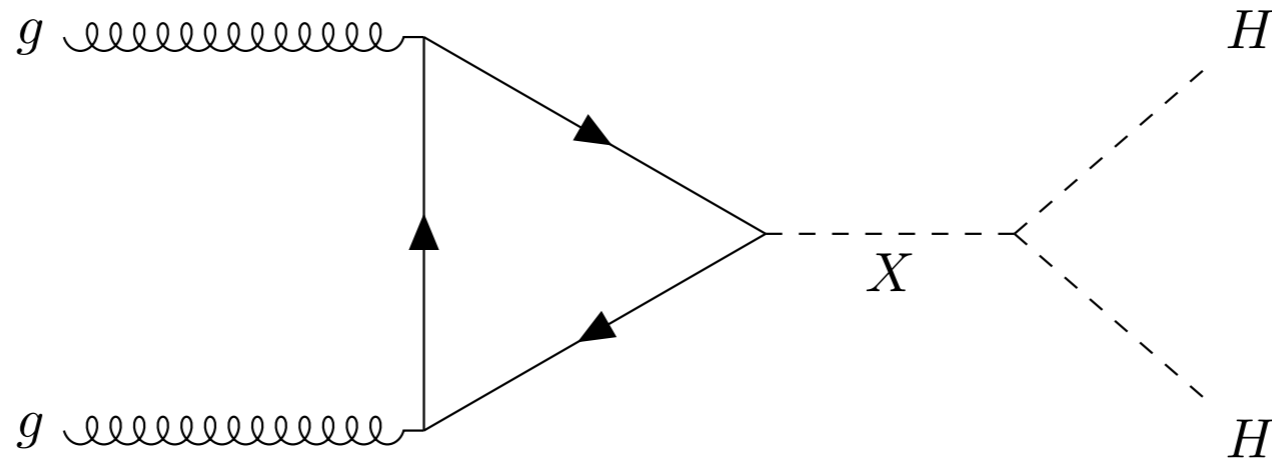

Depending on mass of X , H can have low or high momentum

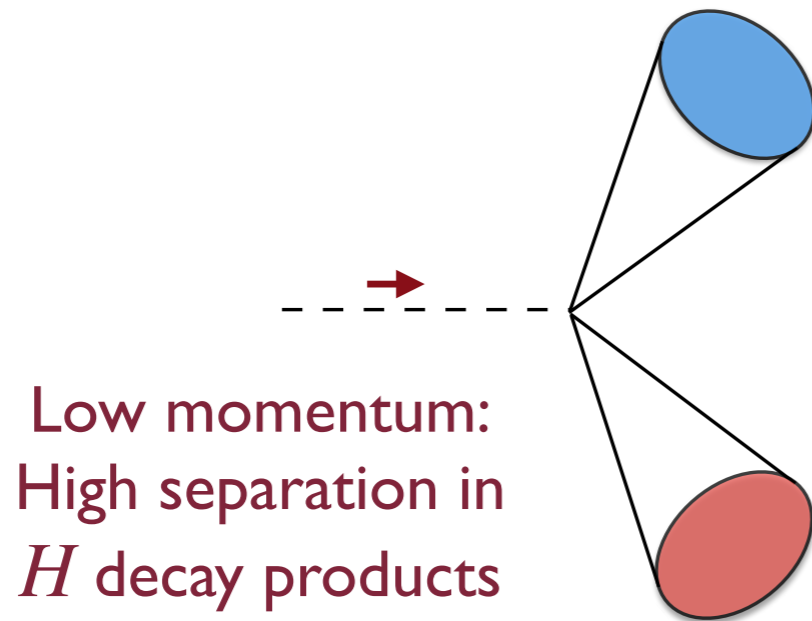

Reconstruct **resolved** decay products

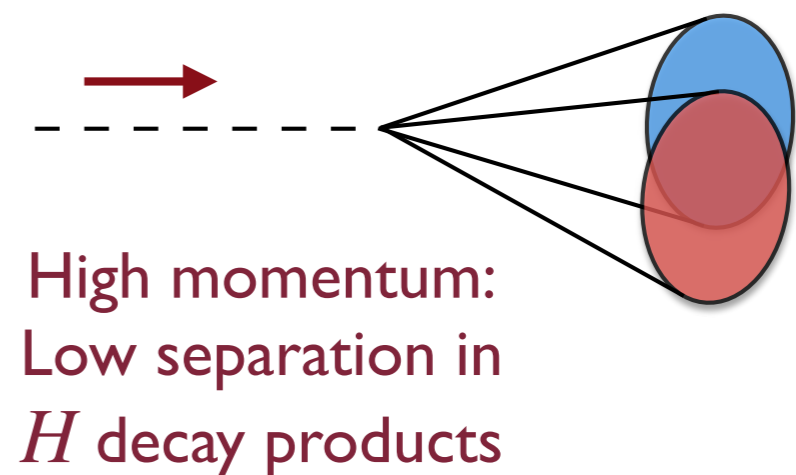

Use **boost** to reconstruct single H object

$HH \rightarrow b\bar{b}b\bar{b}$ Resolved

$HH \rightarrow b\bar{b}b\bar{b}$ Boosted

[arXiv:2301.03212](https://arxiv.org/abs/2301.03212)

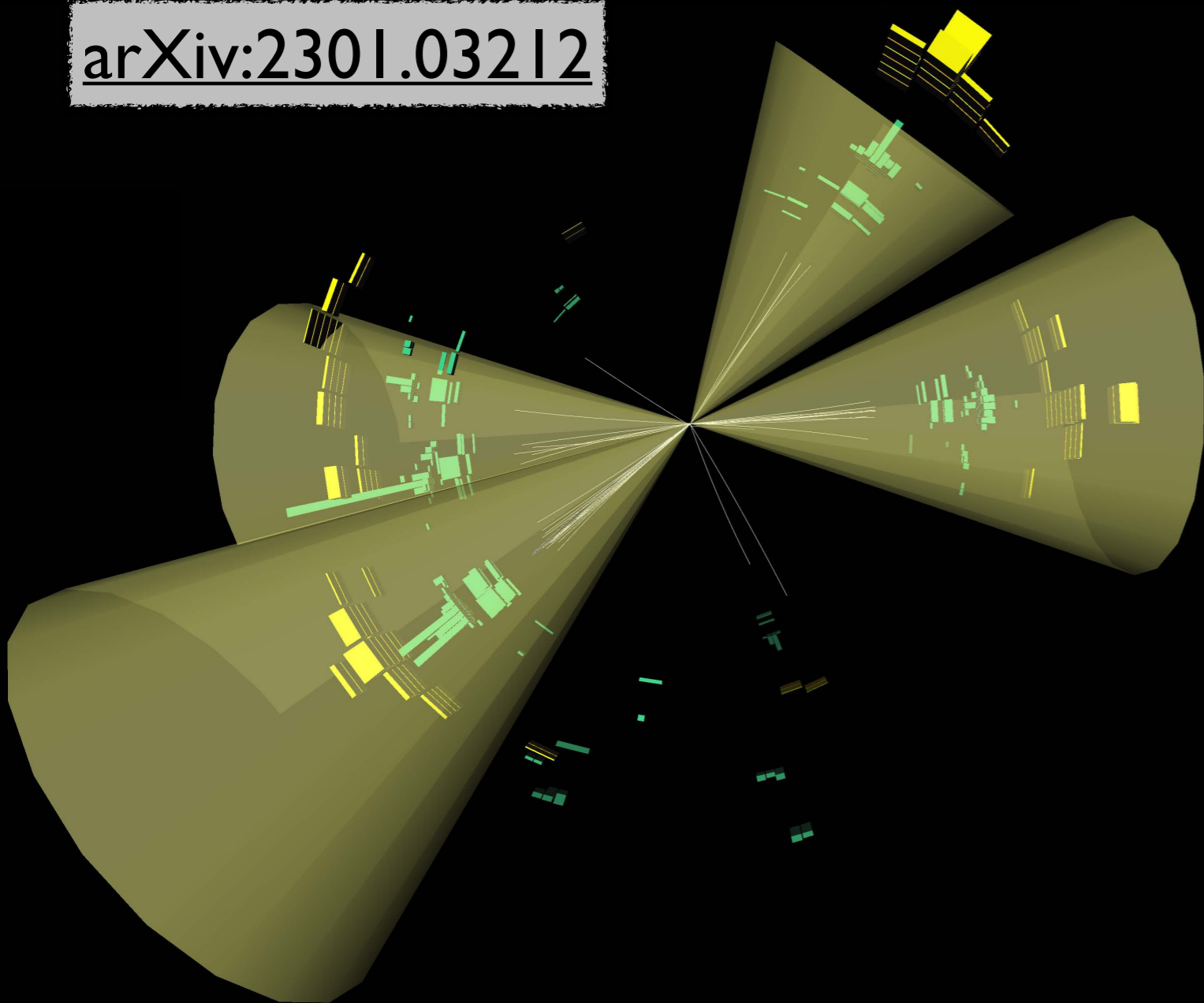

Combination of 12 b-jet triggers

4 b-tagged jets
($\epsilon = 77\%$, $p_T > 40$ GeV)

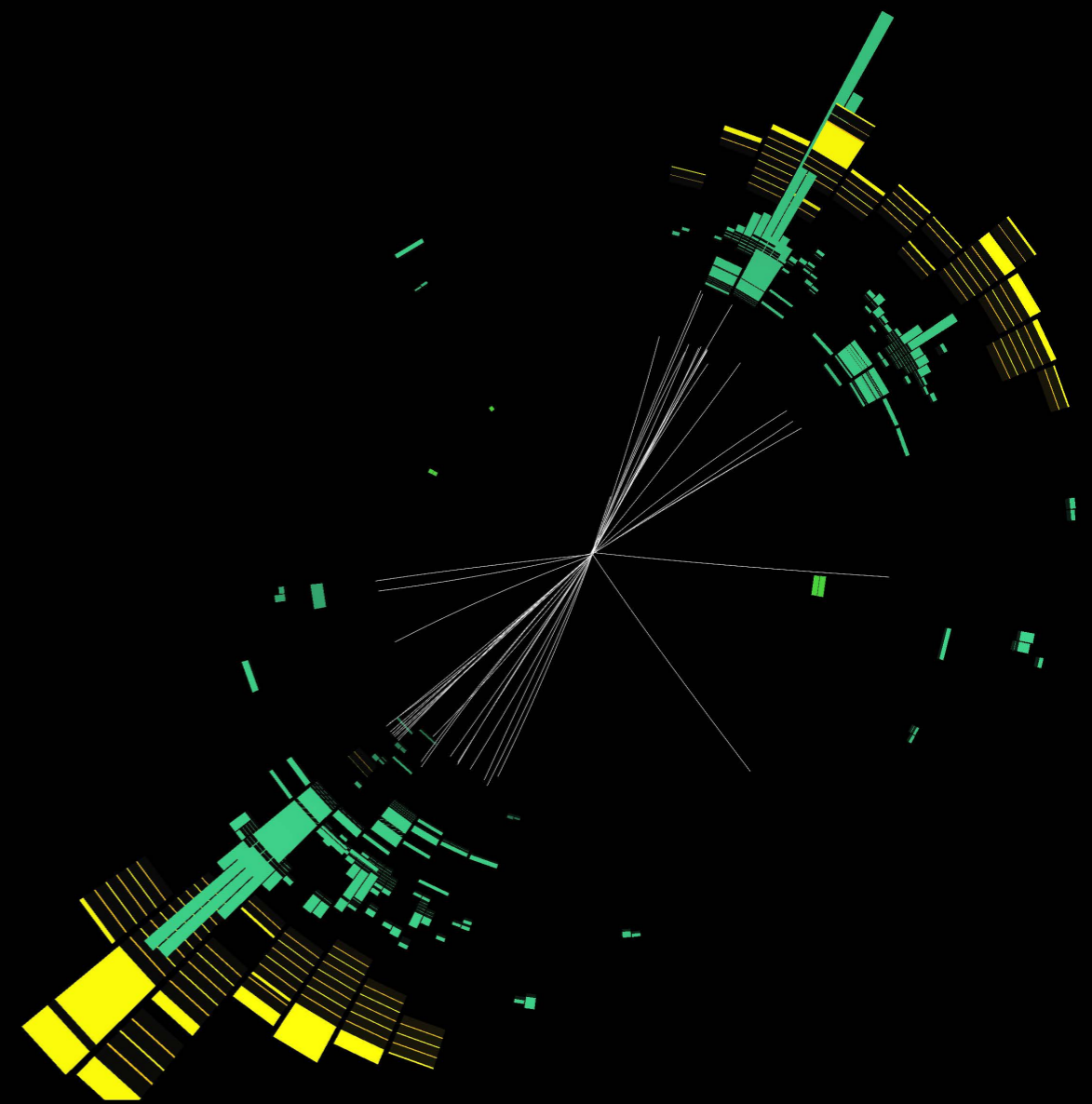

Large-R jet trigger ($E_T > 450$ GeV)

Two large-R jets
($R=1.0$, $p_T > 450$ (250) GeV)

Boosted Decision Tree used to pair jets

2, 3, or 4 b-tags (via track-jets, $\epsilon = 77\%$)

$b\bar{b}b\bar{b}$ Analysis Strategy

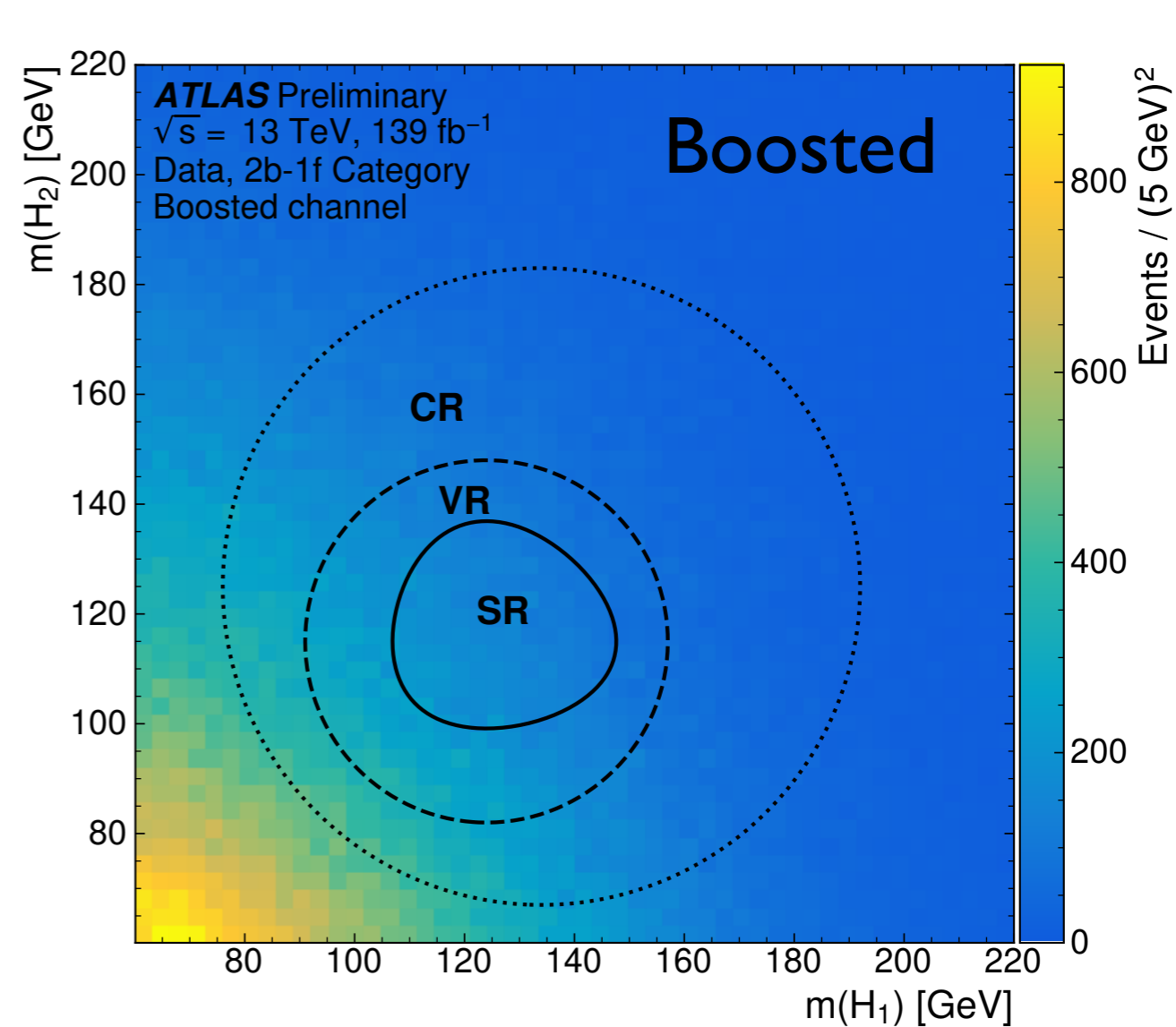
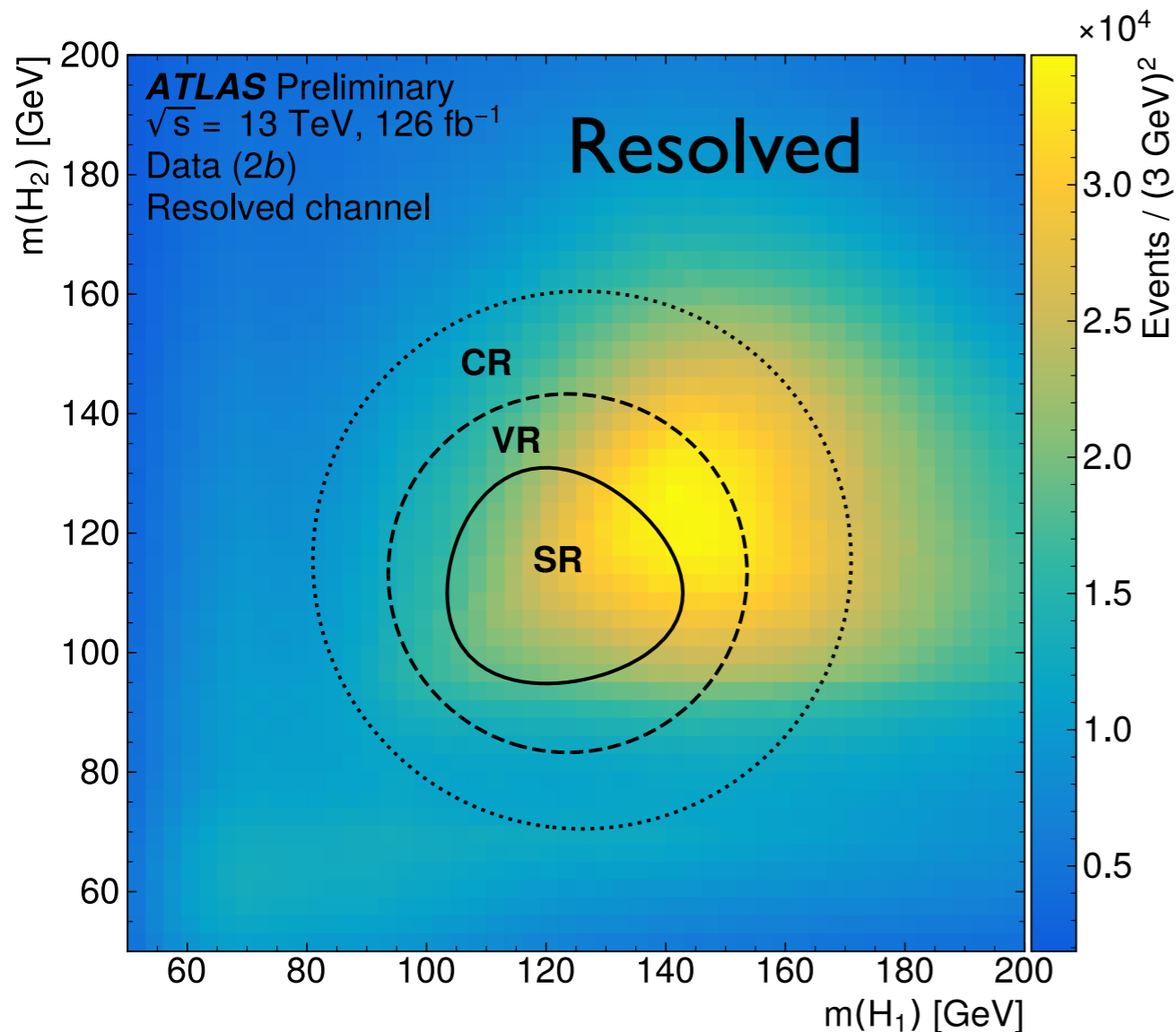

Reconstruct Higgs candidates, form “mass plane”

Center is signal-like; outer regions used for background and background validation

Fit m_{HH} in signal region for final analysis

$b\bar{b}b\bar{b}$ Resolved Background

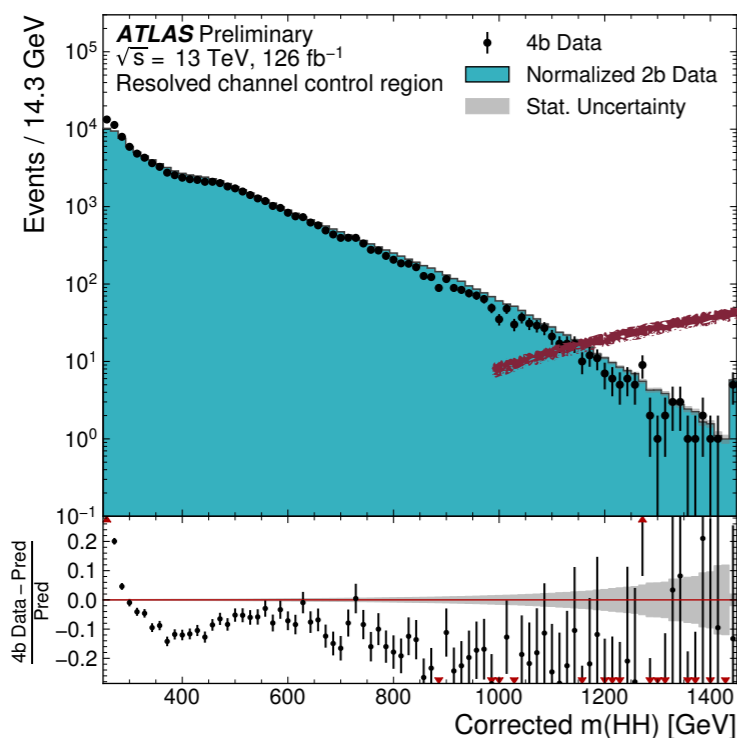
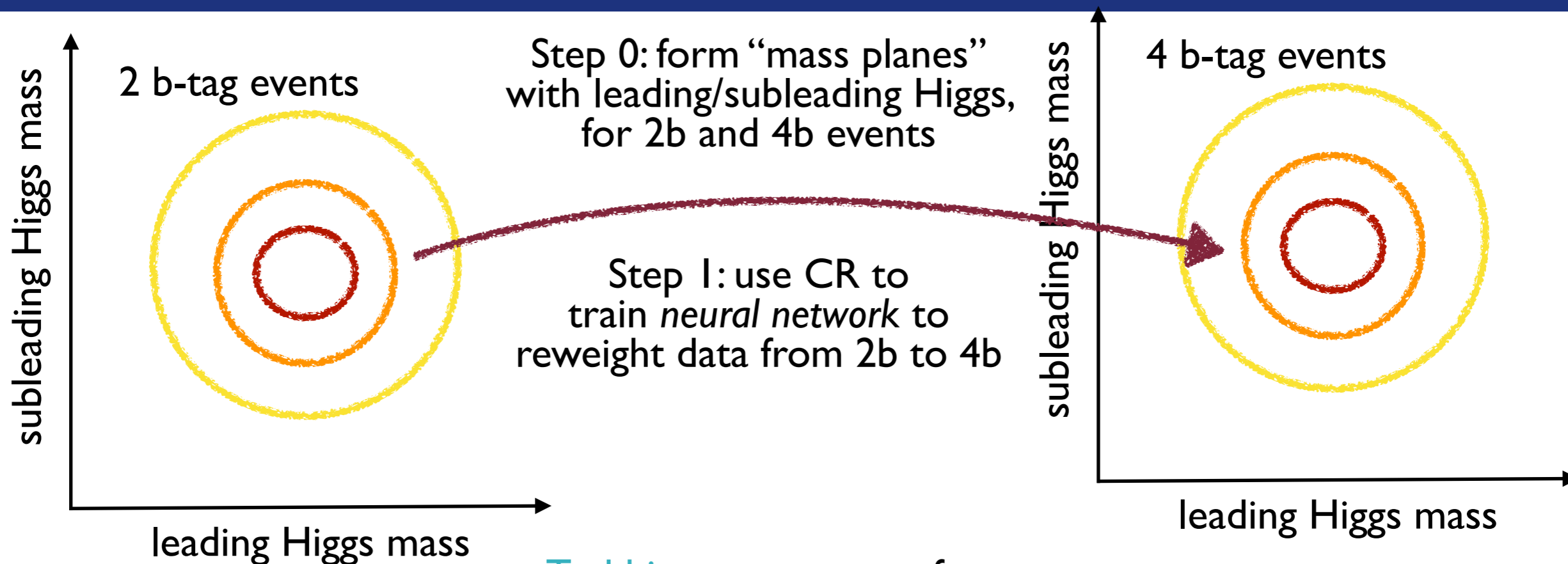
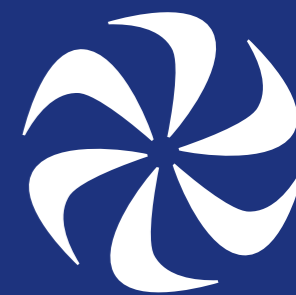

Teal histogram comes from 2b, black points from 4b

Neural network

Step 2: Apply this NN to 2b SR: prediction for 4b SR

Systematics from alternate regions

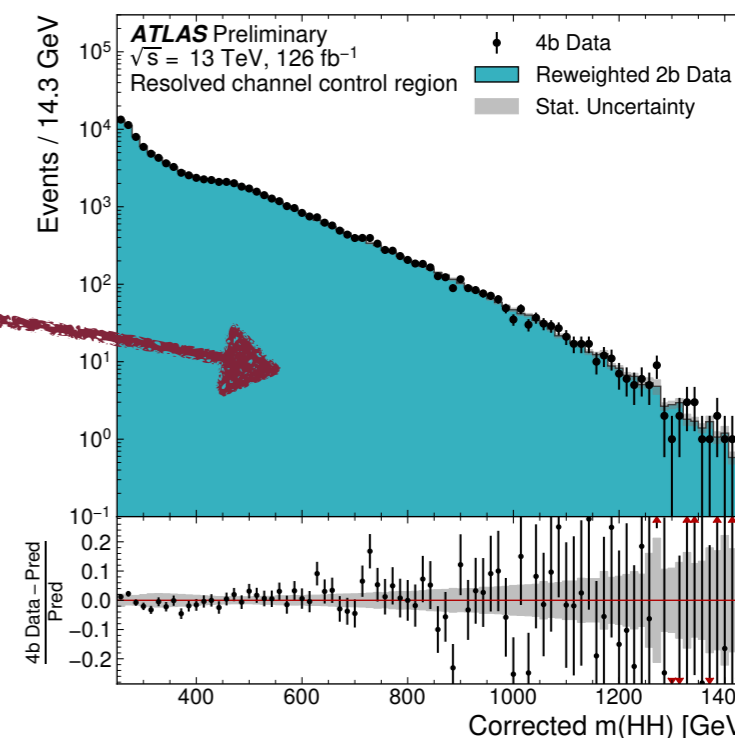

Why Neural Networks?

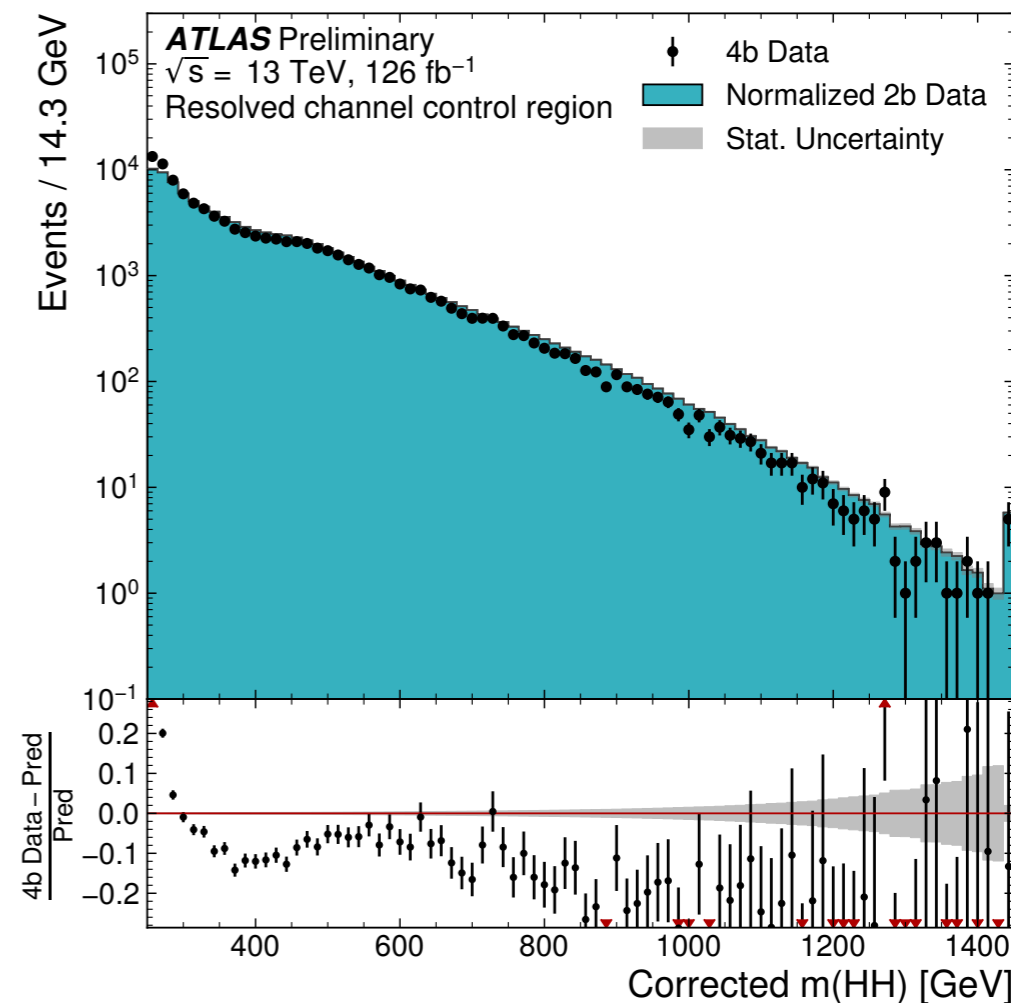
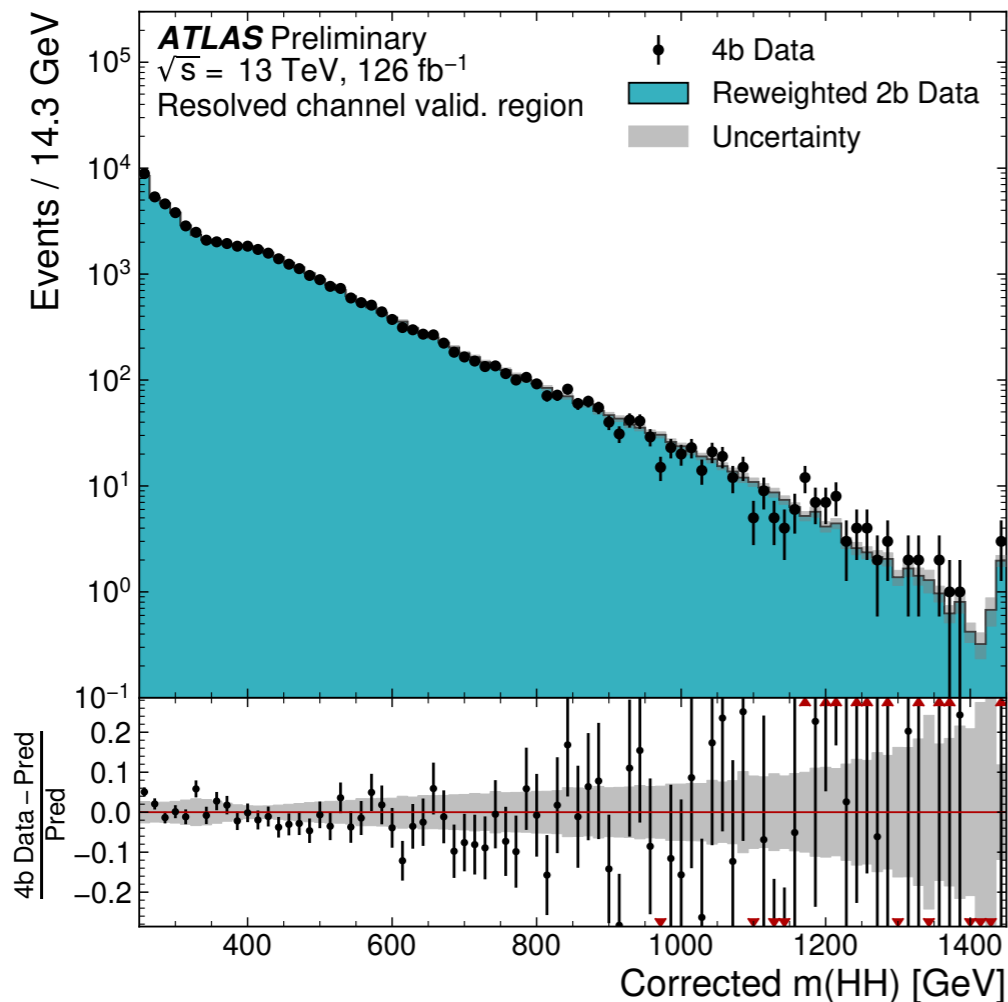
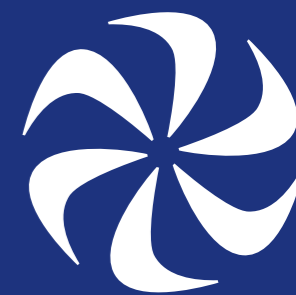

Here, apply NN to 2b data in VR

Works well, even on data that wasn't used in training!

Why does this work?

NN's learn a density ratio of two classes: normally this ratio is used to isolate a single class, but can be used to reweight classes

$b\bar{b}b\bar{b}$ Results

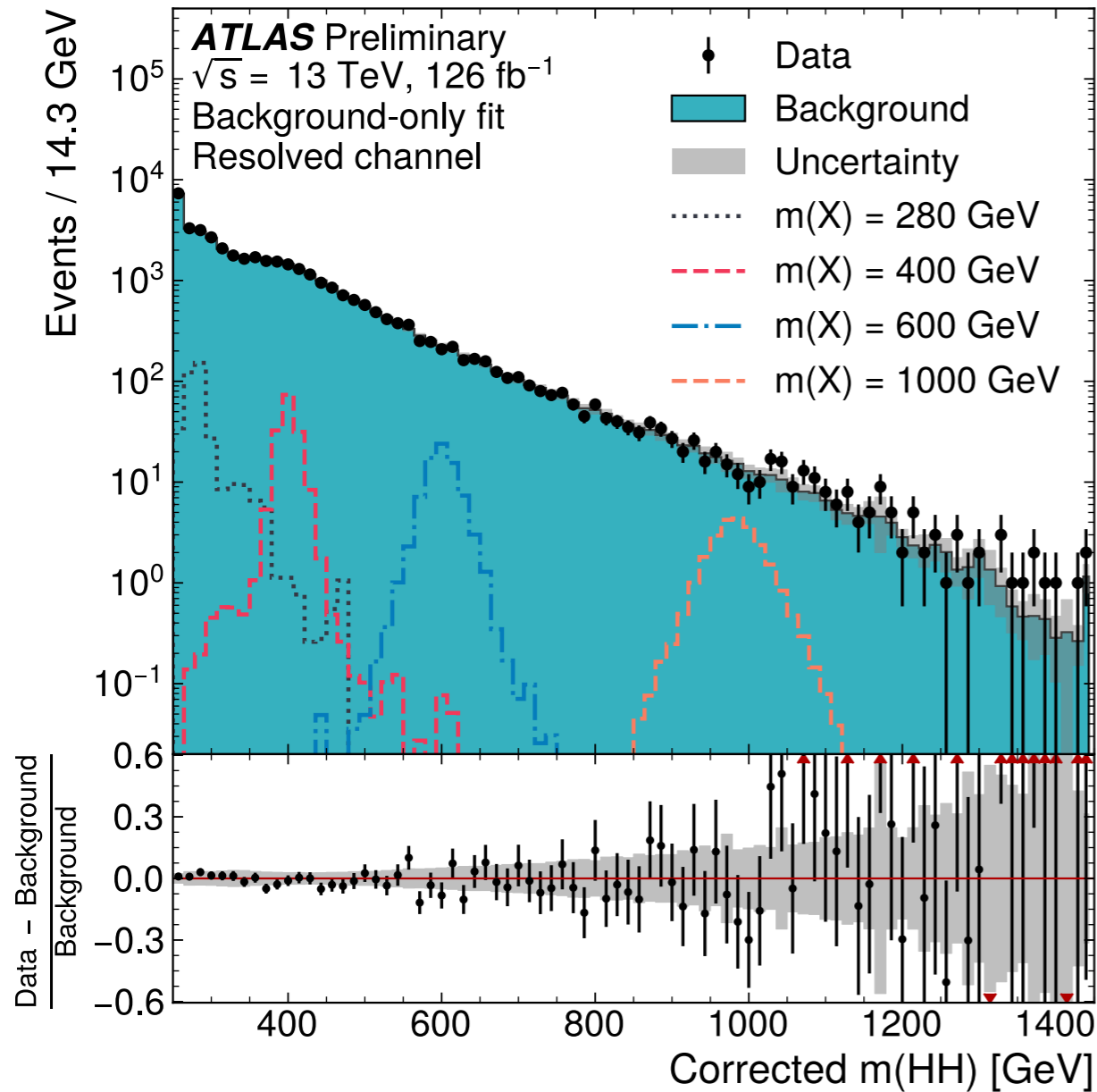

Data agrees well with background prediction

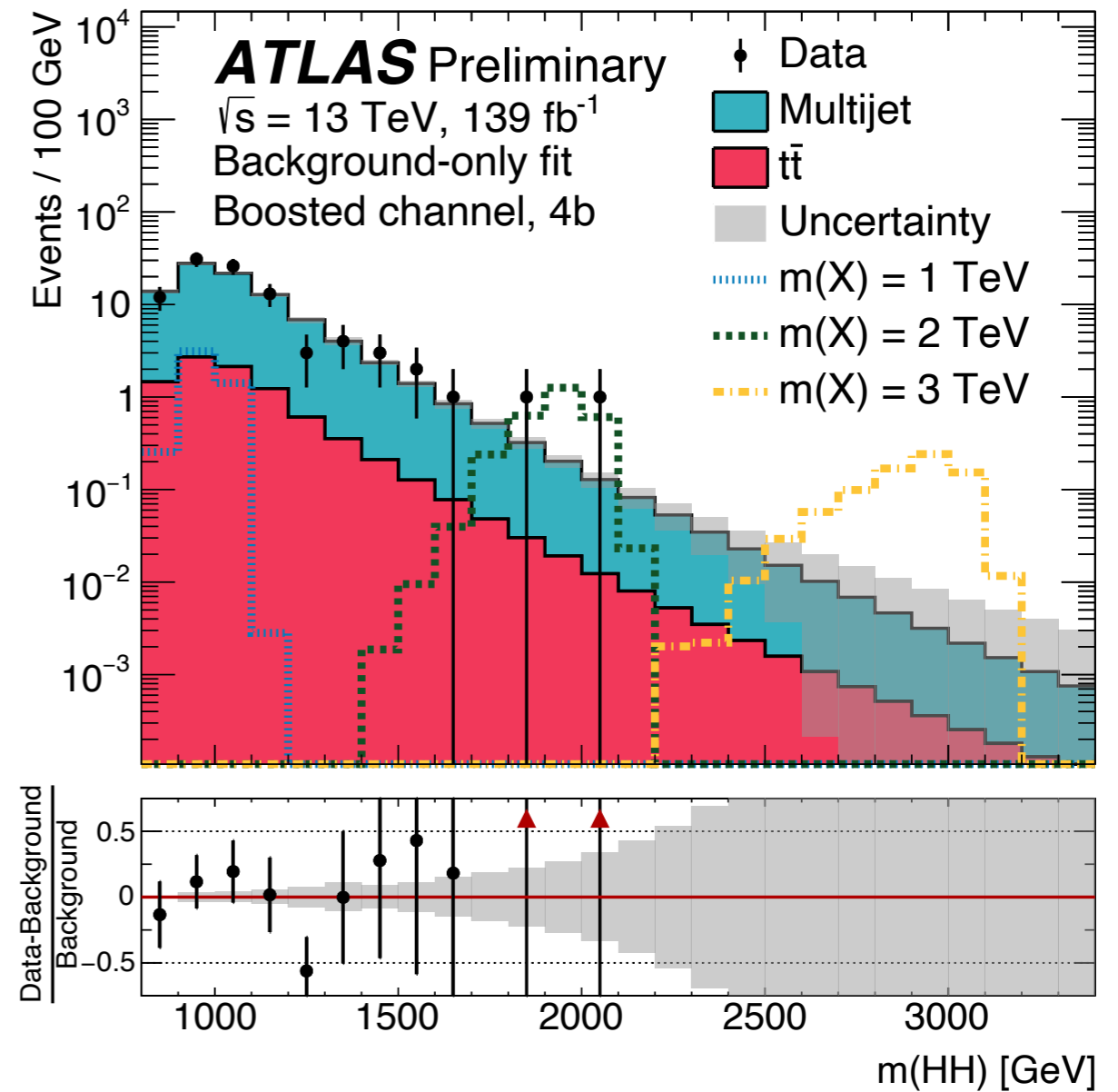

Boosted analysis is similar:
 simpler spline based reweighting

No excess either (also in 3b and 2b SR)

Resonant Combination

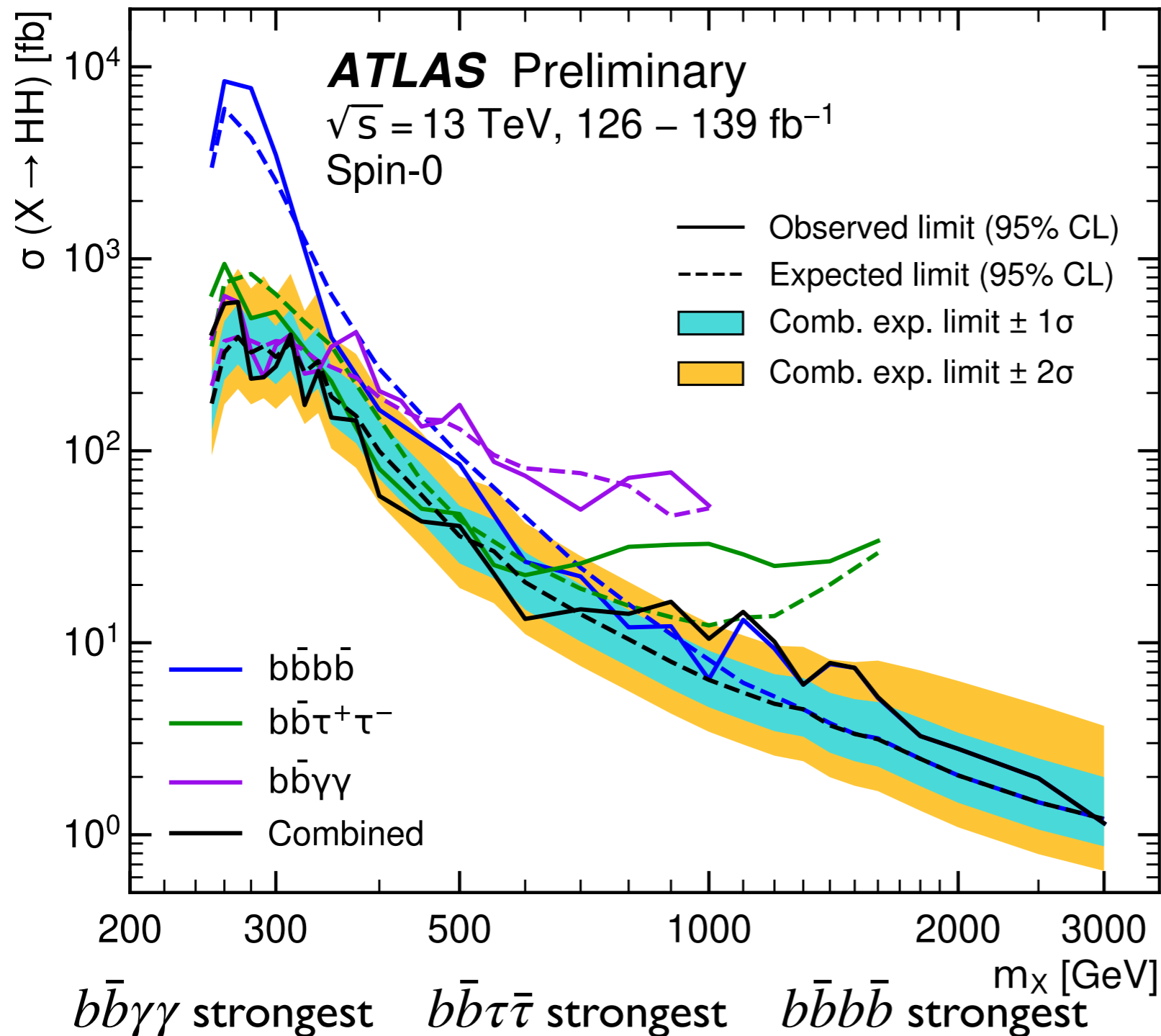

Here, show results from all three analyses

$b\bar{b}\gamma\gamma$ and $b\bar{b}\tau\tau$ have similar resonant-optimized searches

($b\bar{b}\tau\tau$ has parameterized NN for different signal mass points)

All three analyses complementary: set best limits at different ranges

Resonant p-value

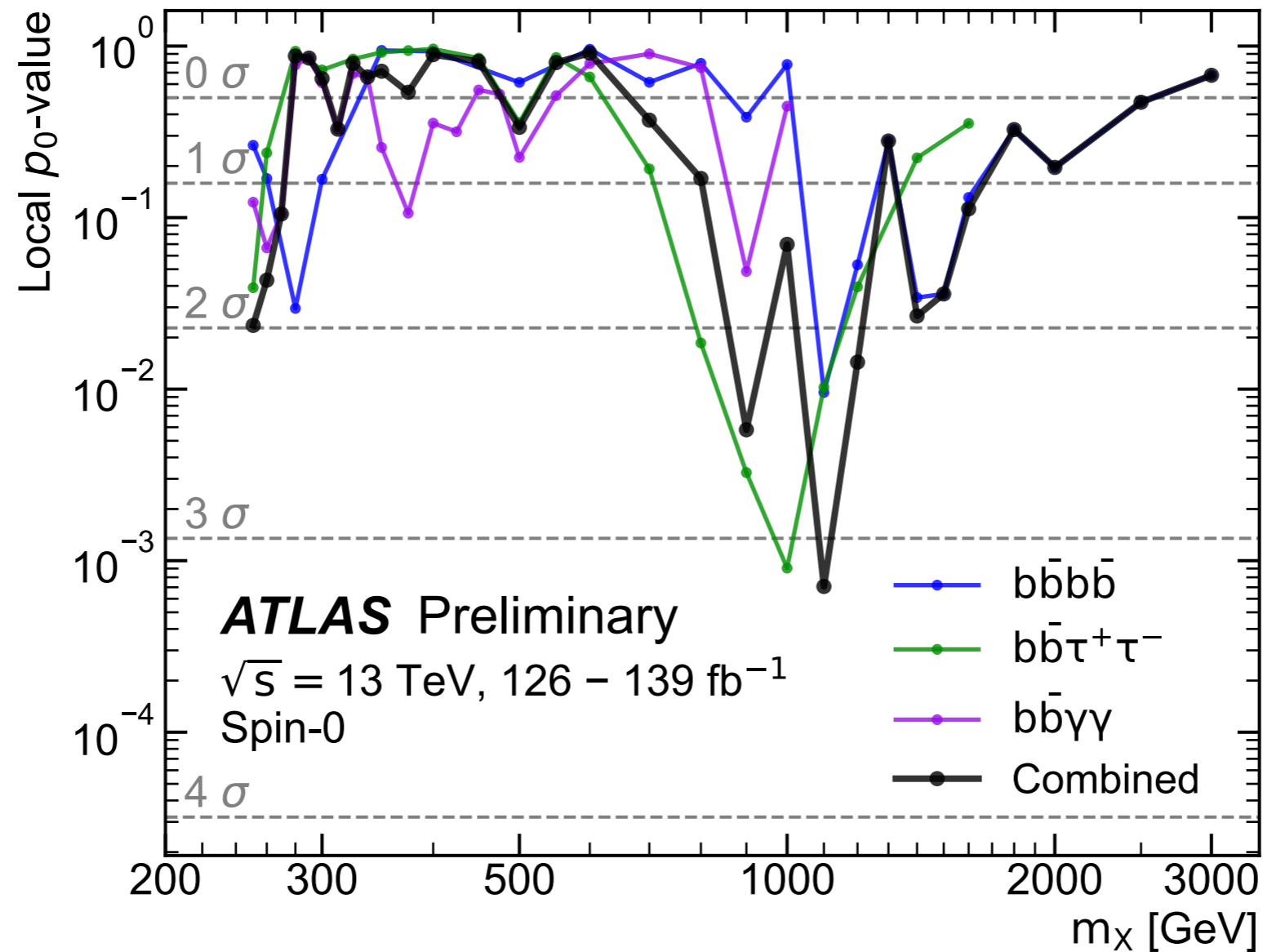

$b\bar{b}\tau\bar{\tau}$ Resonant Limits

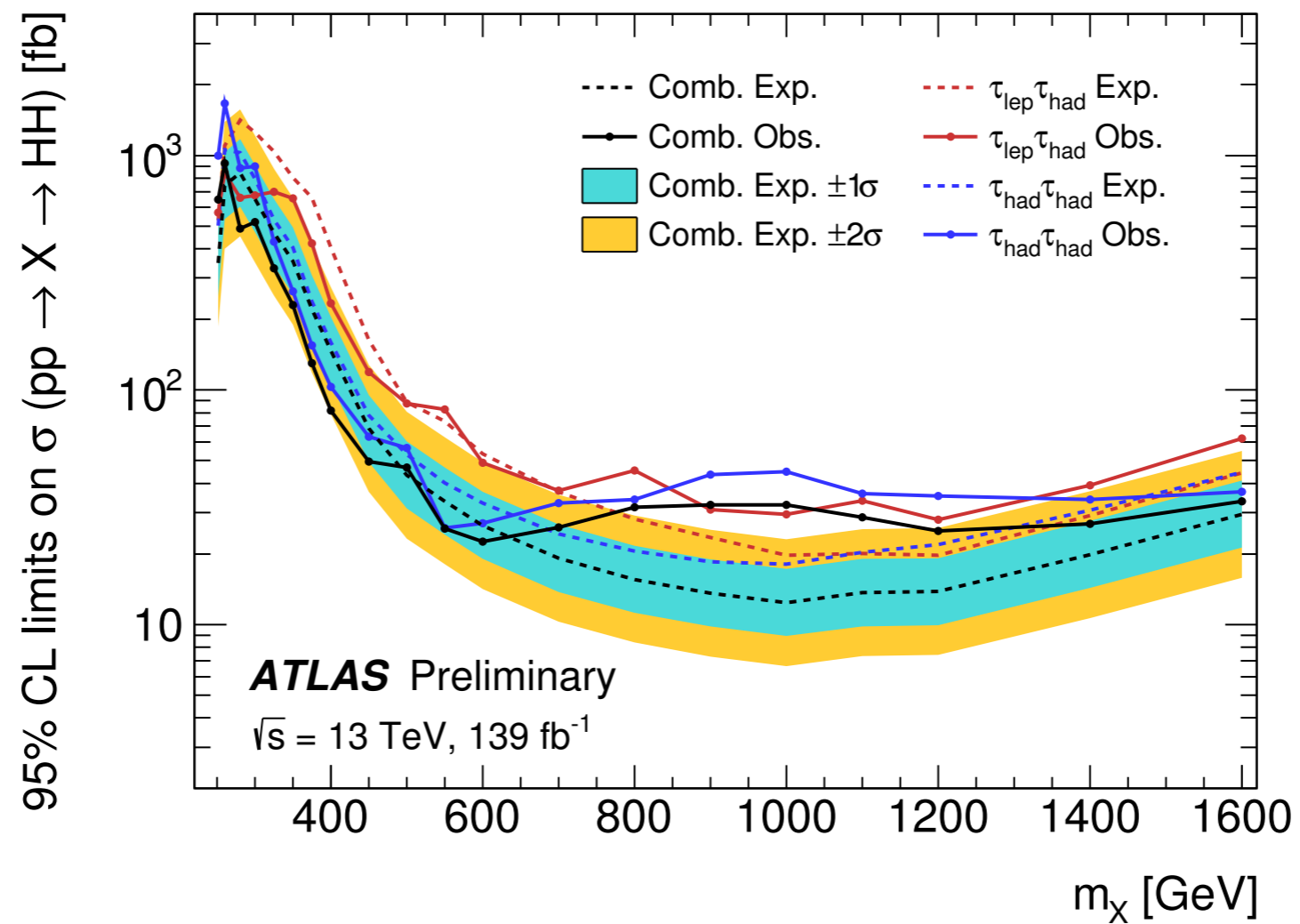

Non-resonant Acc x Eff

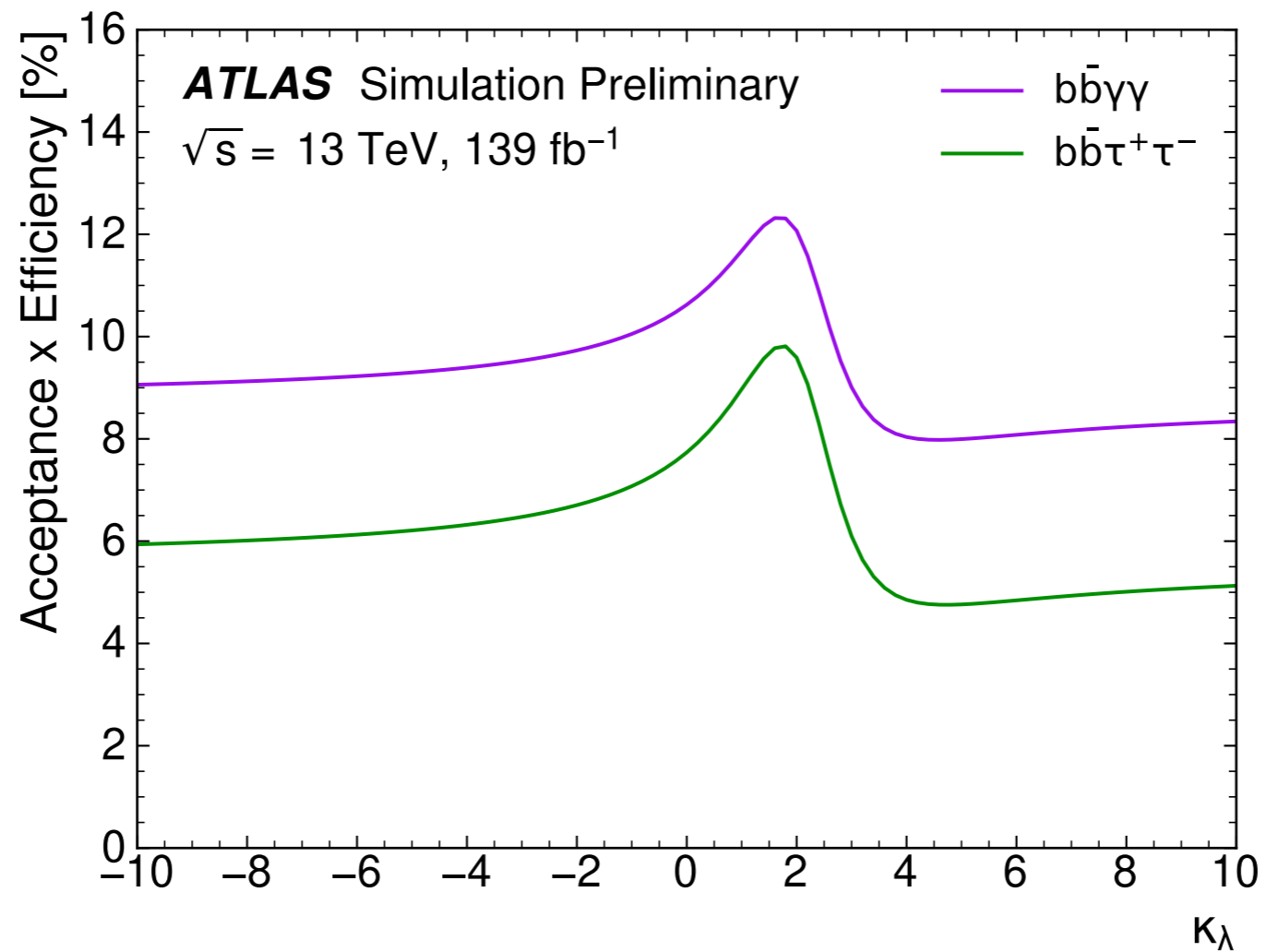

Variables for MVAs



- For $b\bar{b}\gamma\gamma$: photon kinematics, b-jet kinematics, bb-system kinematics, missing energy, total energy, “top-ness”
- For $b\bar{b}\tau\bar{\tau}$: m_{HH} , m_{bb} , $m_{\tau\tau}$, $DR(b,b)$, $DR(\tau,\tau)$, $DPt(l\text{ep},\tau)$, MET, $DPhi(l\text{ep}\tau, bb)$...
- For $b\bar{b}b\bar{b}$:
 1. $\log(p_T)$ of the selected jet with the 2nd-highest p_T ,
 2. $\log(p_T)$ of the selected jet with the 4th-highest p_T ,
 3. $\log(\Delta R)$ between the two selected jets with the smallest ΔR ,
 4. $\log(\Delta R)$ between the other two selected jets,
 5. the average $|\eta|$ of selected jets,
 6. $\log(p_T)$ of the HH system,
 7. ΔR between the two H candidates,
 8. $\Delta\phi$ between the jets making up H_1 ,
 9. $\Delta\phi$ between the jets making up H_2 ,
 10. $\log(\min(X_{Wt}))$, and
 11. the number of jets in the event with $p_T > 40$ GeV and $|\eta| < 2.5$, including jets that are not selected.

$b\bar{b}\gamma\gamma$ Background Estimate

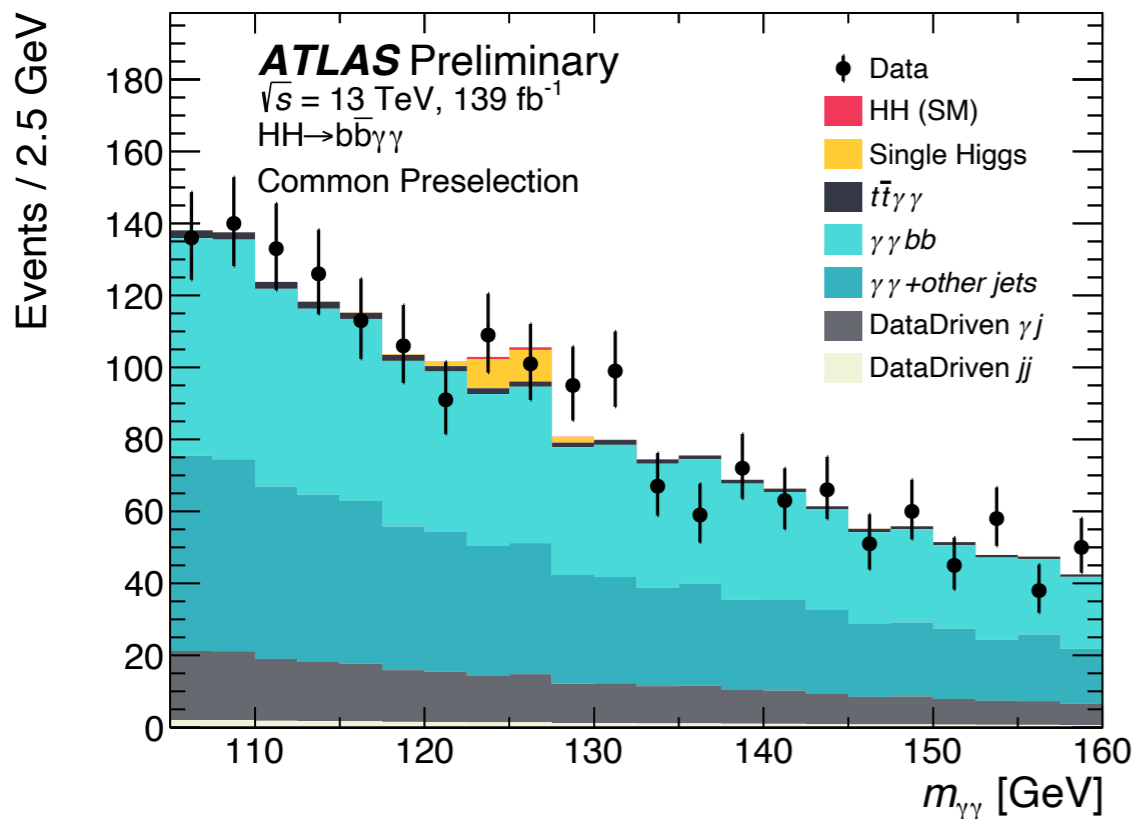
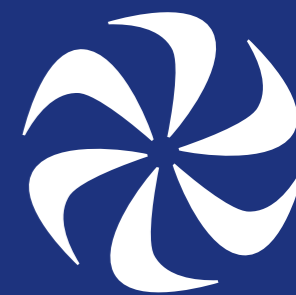

Background estimate formed on fit to $m_{\gamma\gamma}$ in different signal regions

Shape of background function determined from MC, normalization determined from data ‘sidebands’

Contributions from fake γ estimated from data using ABCD method

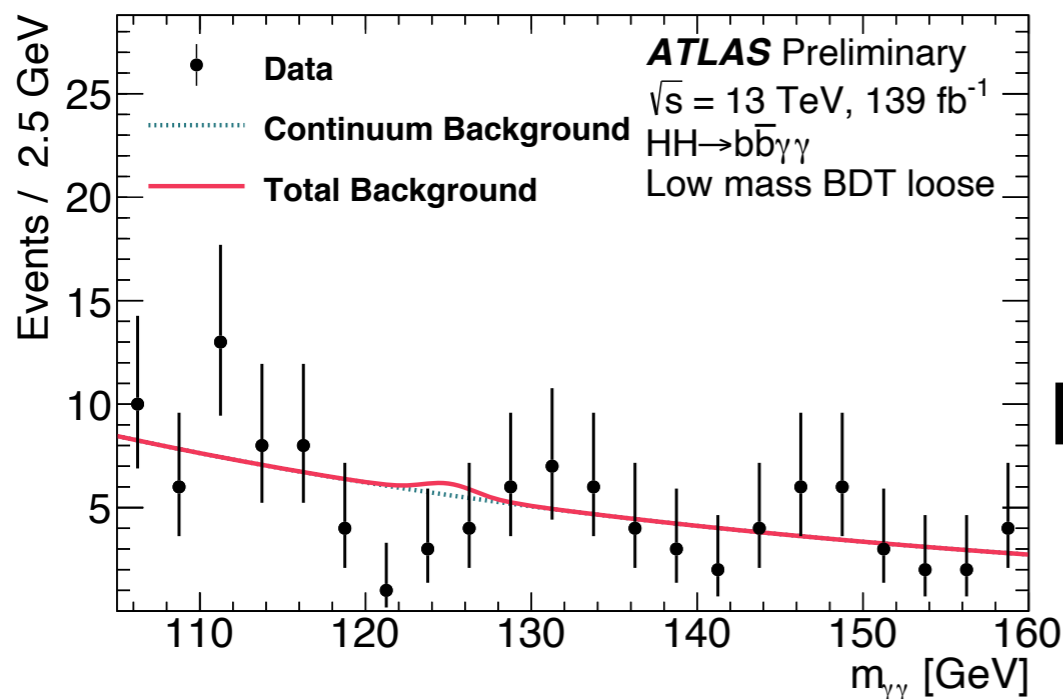

Single Higgs background determined from MC

Largest systematic from “spurious signal”: fit signal + background on background-only MC template

$b\bar{b}\tau\tau$ Background Estimate

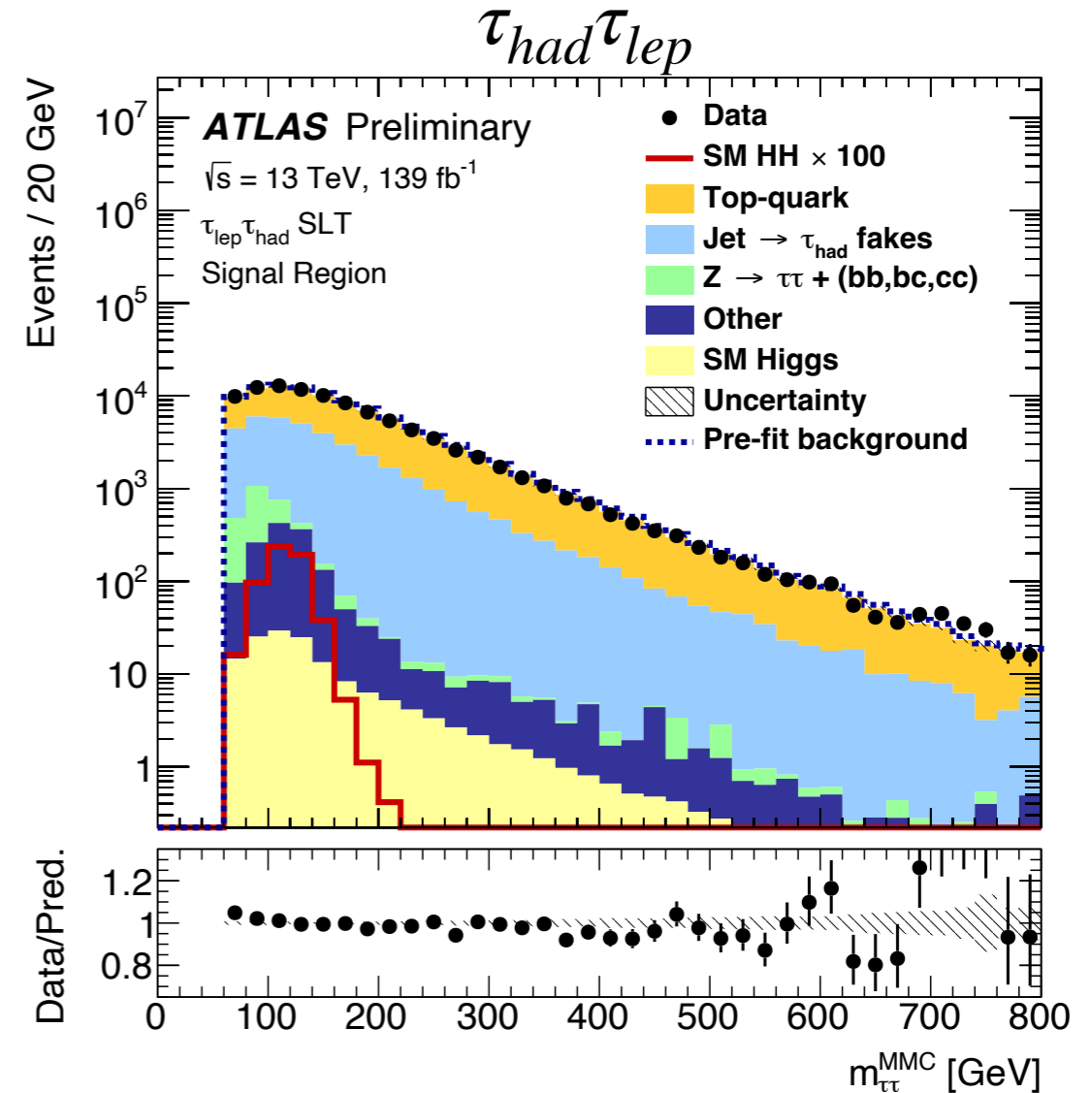
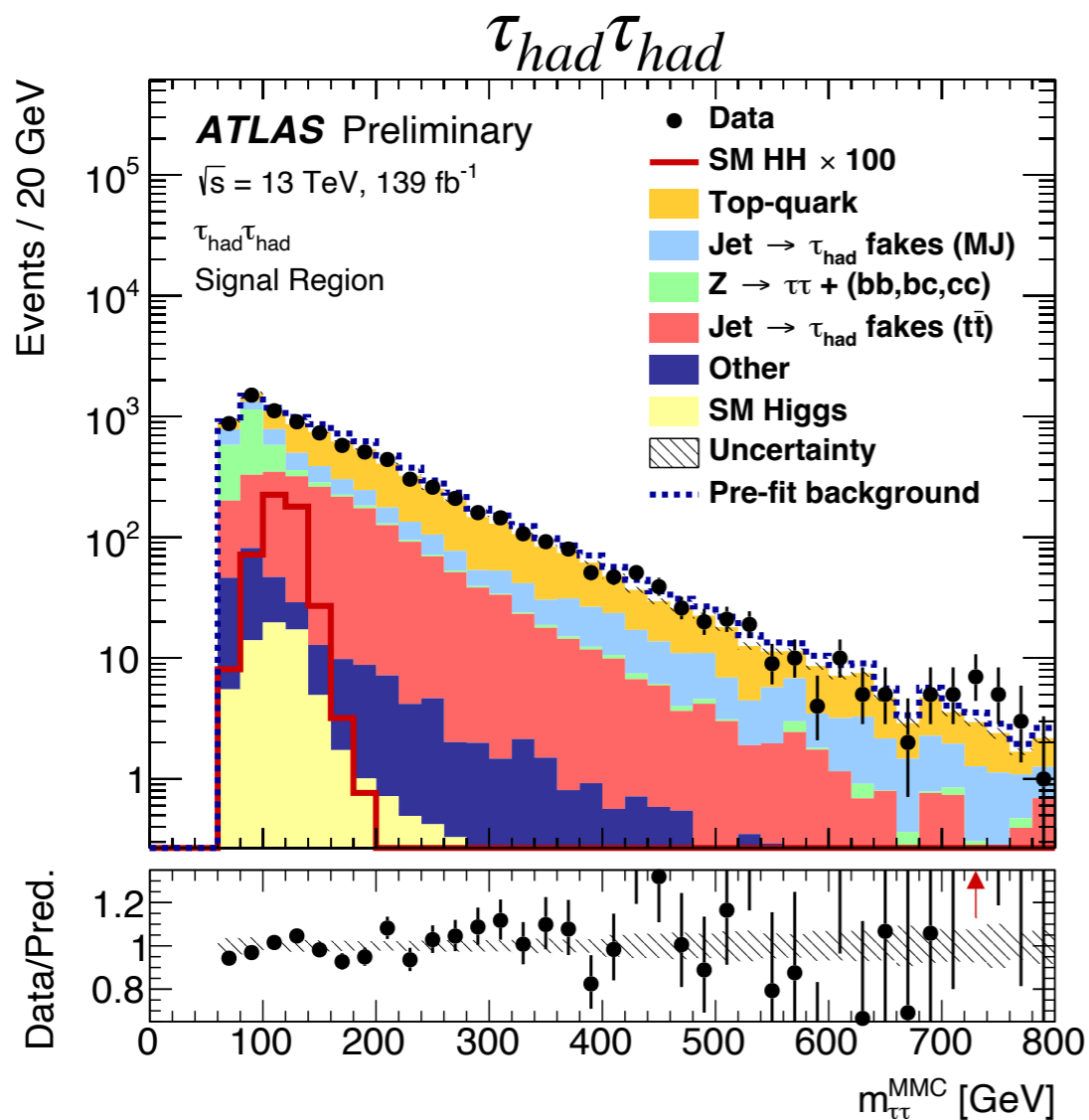

Top-quark background from MC, normalization floating in final fit

Z+jets background from MC, normalization from leptonic CR

Fake τ estimated from data using “fake factor” method

$b\bar{b}\tau\tau$ Strategy and Results

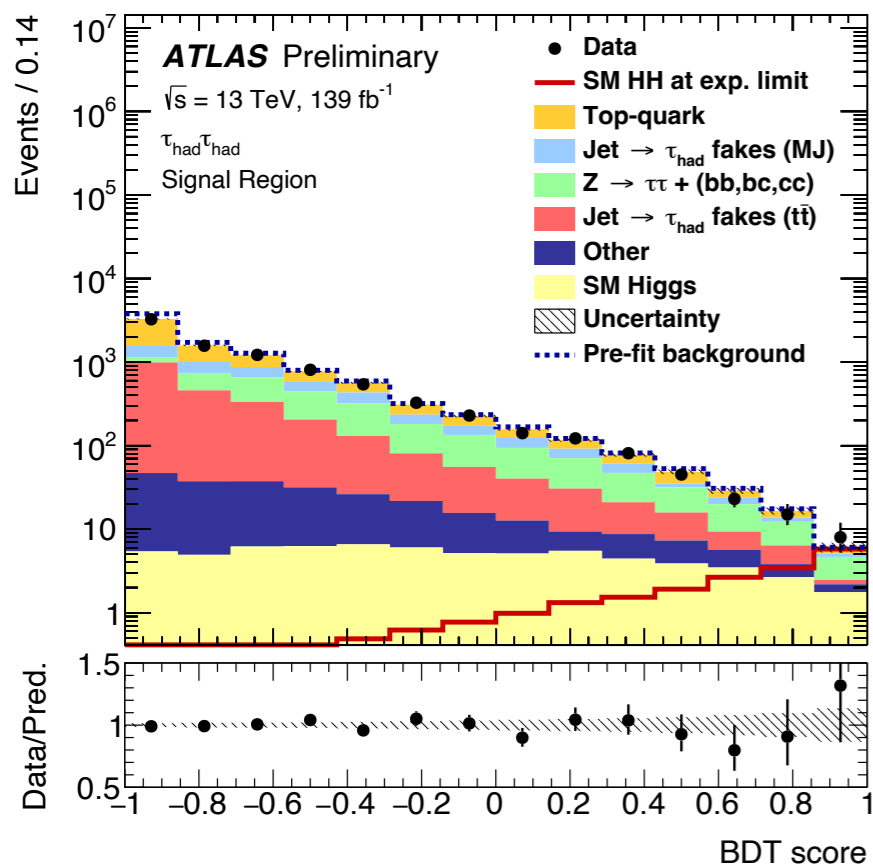
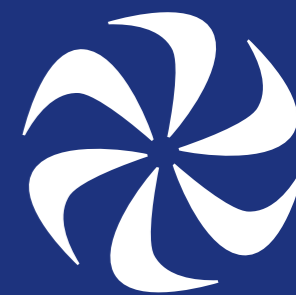

$\tau_{had}\tau_{had}$ BDT

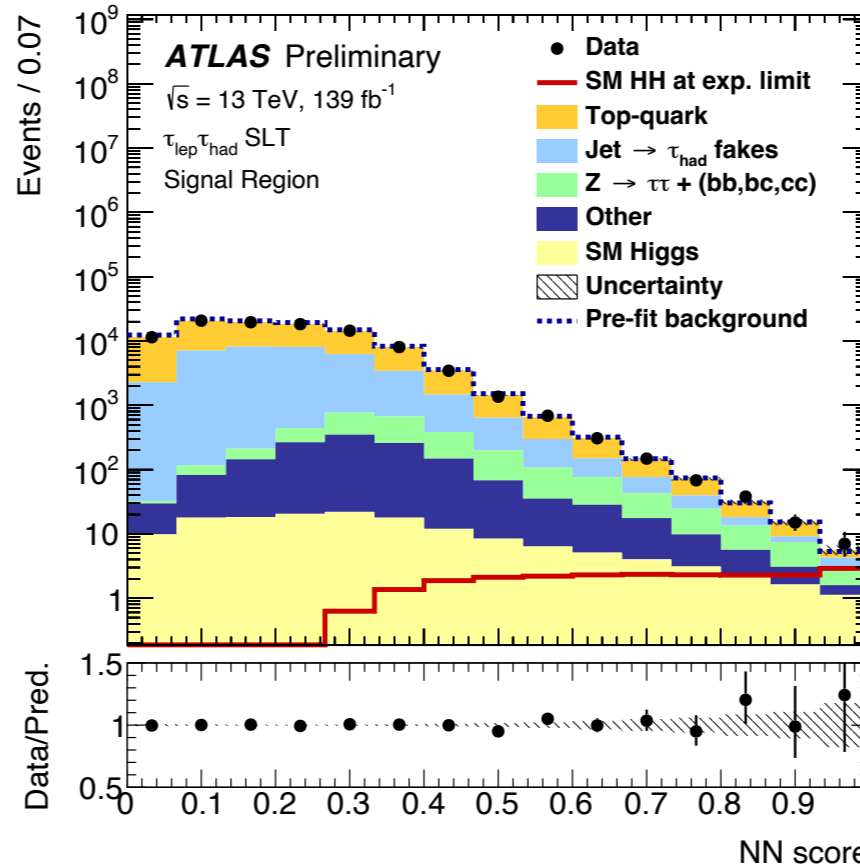

$\tau_{had}\tau_{lep}$ I-Lepton Trigger
Neural Network

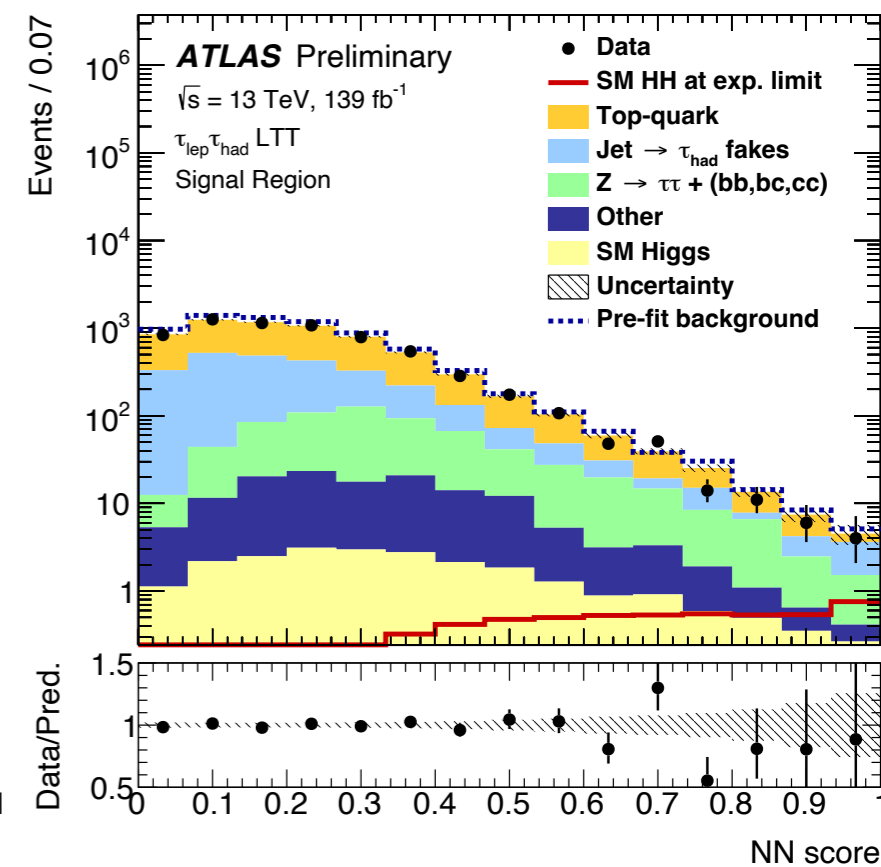

$\tau_{had}\tau_{lep}$ Lepton+Tau
Neural Network

Fits to BDT/NN shape used for final analysis
Data agrees well with background prediction

$\tau_{had}\tau_{had}$ has strongest sensitivity, but other channels also contribute

Universe Stability

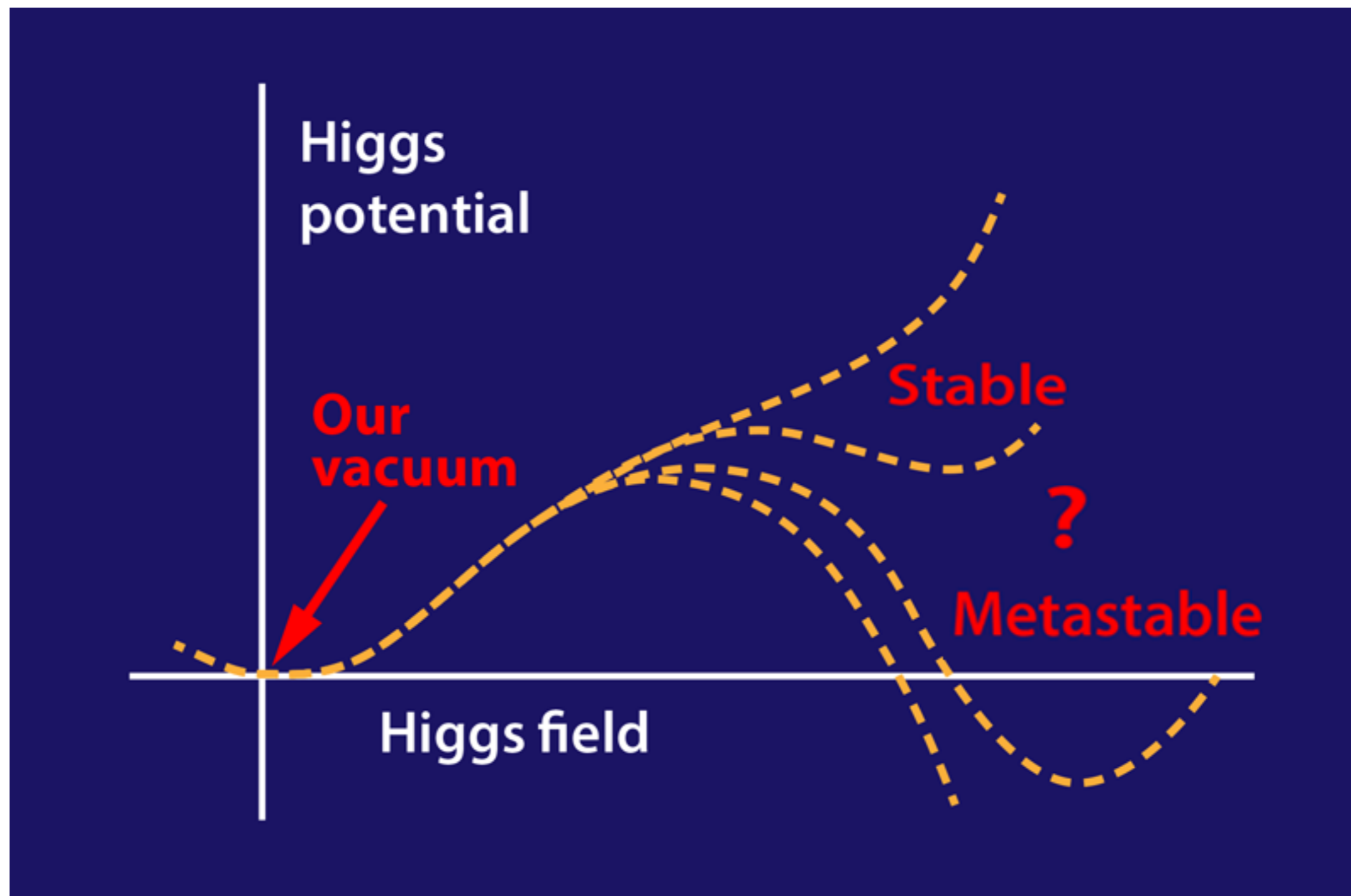
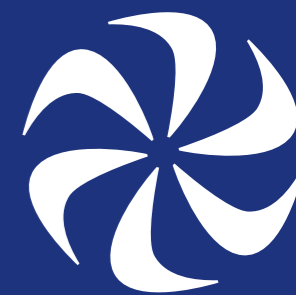

A. Kusenko

Interference



$$\sigma \propto \left| \left[\begin{array}{c} g \text{ wavy line} \rightarrow \begin{array}{c} \nearrow t/b \\ \searrow \end{array} \begin{array}{c} \kappa_t \quad \kappa_\lambda \\ \dashrightarrow H \end{array} \begin{array}{c} \nearrow H \\ \searrow H \end{array} \\ g \text{ wavy line} \rightarrow \begin{array}{c} \nearrow \end{array} \end{array} \right]^2 - \left(\begin{array}{c} g \text{ wavy line} \rightarrow \begin{array}{c} \nearrow t/b \\ \searrow \end{array} \begin{array}{c} \kappa_t \quad \kappa_\lambda \\ \dashrightarrow H \end{array} \begin{array}{c} \nearrow H \\ \searrow H \end{array} \\ g \text{ wavy line} \rightarrow \begin{array}{c} \nearrow \end{array} \end{array} \right) \left[\begin{array}{c} g \text{ wavy line} \rightarrow \begin{array}{c} \rightarrow \kappa_t \\ \dashrightarrow H \end{array} \begin{array}{c} \rightarrow \end{array} \\ g \text{ wavy line} \rightarrow \begin{array}{c} \rightarrow t/b \\ \dashrightarrow H \end{array} \begin{array}{c} \rightarrow \end{array} \\ g \text{ wavy line} \rightarrow \begin{array}{c} \rightarrow \kappa_t \\ \dashrightarrow H \end{array} \begin{array}{c} \rightarrow \end{array} \\ g \text{ wavy line} \rightarrow \begin{array}{c} \rightarrow \end{array} \end{array} \right] + h.c. \left. \right) + \left| \left[\begin{array}{c} g \text{ wavy line} \rightarrow \begin{array}{c} \rightarrow \kappa_t \\ \dashrightarrow H \end{array} \begin{array}{c} \rightarrow \end{array} \\ g \text{ wavy line} \rightarrow \begin{array}{c} \rightarrow t/b \\ \dashrightarrow H \end{array} \begin{array}{c} \rightarrow \end{array} \\ g \text{ wavy line} \rightarrow \begin{array}{c} \rightarrow \kappa_t \\ \dashrightarrow H \end{array} \begin{array}{c} \rightarrow \end{array} \\ g \text{ wavy line} \rightarrow \begin{array}{c} \rightarrow \end{array} \end{array} \right]^2 \end{array} \right.$$