

JULY 25, 2024

AAC 2024

TESTING OF A W-BAND CORRUGATED WAVEGUIDE FOR HIGH-GRADIENT HIGH- EFFICIENCY WAKEFIELD ACCELERATION

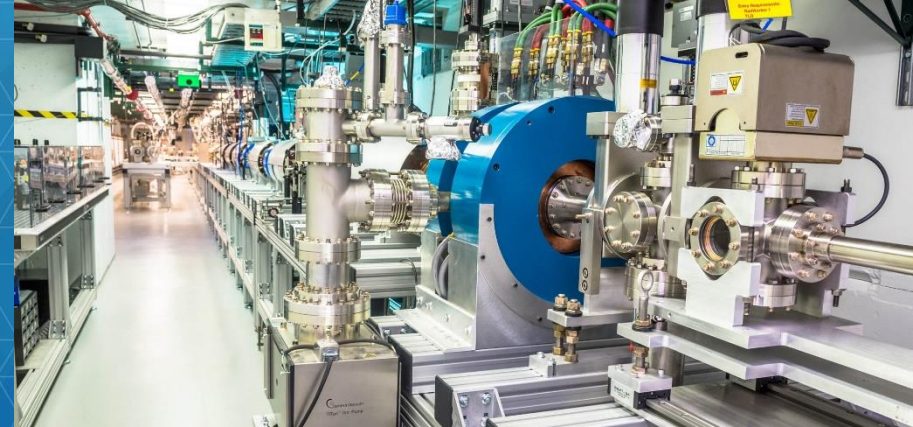

BRENDAN LEUNG¹

Alexander Ody², Calcifer Phillips¹, Charles Whiteford², Scott Doran², Eric Wisniewski², Gwanghui Ha¹, John Power², Philippe Piot², Wanming Liu², Xueying Lu^{1,2}

1: NIU

2: Argonne



Argonne National Laboratory is a
U.S. Department of Energy laboratory
managed by UChicago Argonne, LLC.



Northern Illinois
University



OUTLINE

- Motivation
 - Collinear Wakefield Acceleration (CWA)
- Structure Design
 - Microwave Simulations
 - Beamline Simulations
- Structure Fabrication and Installation
- Preliminary Experimental Results
- Conclusion and Acknowledgements

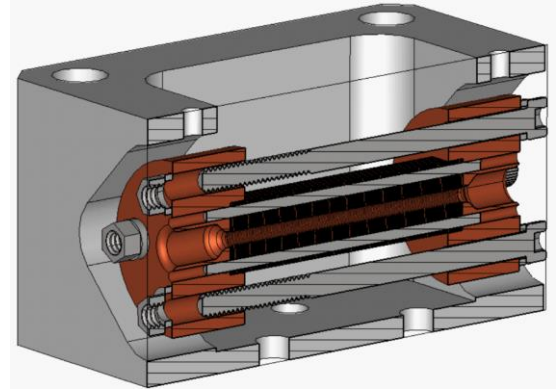

COLLINEAR WAKEFIELD ACCELERATION

- Scheme of structure wakefield acceleration (SWFA) where a high charge drive bunch accelerates a trailing witness bunch
- The amount the witness beam is accelerated is determined by the gradient, the strength of the wakefield
- The efficiency of the energy transfer between drive and witness is measurable via the transformer ratio, the accelerating gradient behind the drive beam divided by the decelerating gradient at the drive beam.

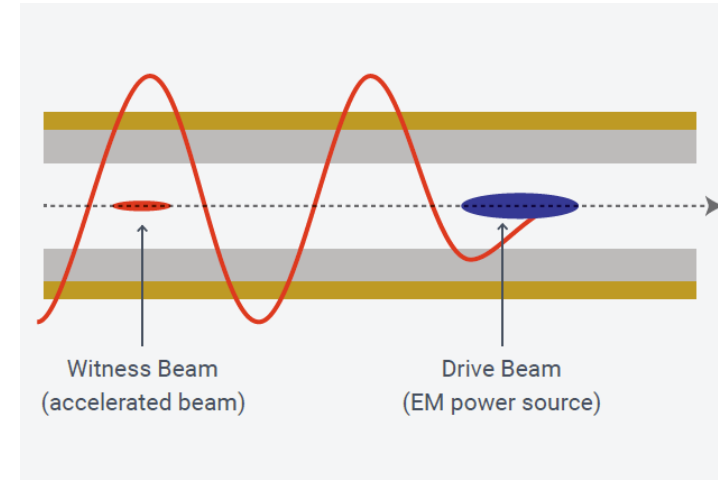

SUB-TERAHERTZ STRUCTURES FOR SWFA

SWFA in the sub-terahertz (THz) regime is of particular interest:

- Compact structures possible due to small transverse size
- A high shunt impedance from frequency scaling allows for high gradient
- The wakefield being confined by a short radiofrequency (RF) pulse can lead to high-efficiency acceleration.
- The high frequency and short RF pulse length can reduce breakdown probability
- Longitudinal bunch shaping can increase the transformer ratio even further.

BUNCH SHAPING USING EMITTANCE EXCHANGE

- Double dogleg emittance exchange (EEX) beamline used at the Argonne Wakefield Accelerator (AWA), consisting of two identical doglegs sandwiching a transverse deflecting cavity (TDC).
- Resultant longitudinal phase space only depends on horizontal phase space, and vice versa. This allows a transverse mask to map to a desired longitudinal beam profile.

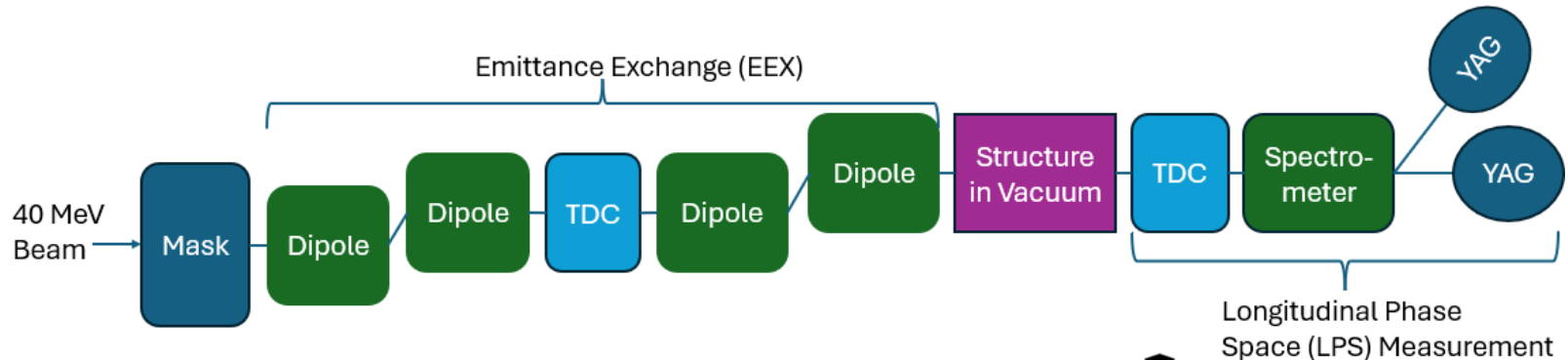

UNIT CELL OPTIMIZATION FOR SUB-THZ STRUCTURE

- Unit cell designed for high gradient at 110 GHz
- Optimized for high gradient with nominal bunch available at AWA.

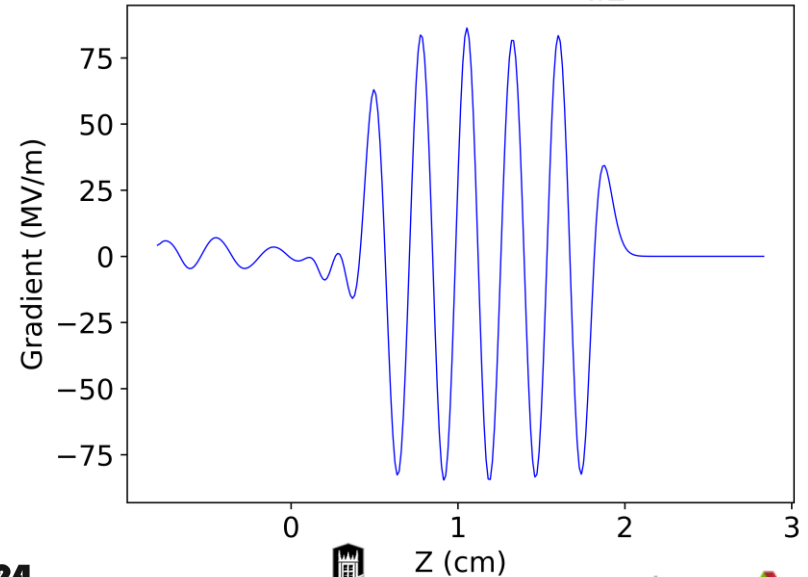
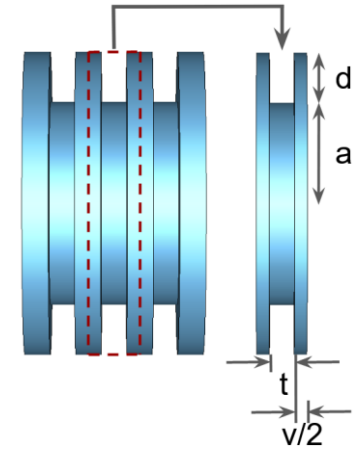

Aperture radius (a)	1.016 mm
Corrugation depth (d)	0.5 mm
Plate thickness 1 (t)	0.254 mm
Plate thickness 2 (v)	0.254 mm
Frequency (f)	110.2 GHz
r/Q	36.5 k Ω/m
Group Velocity (v_g)	0.261 c
Nominal AWA bunch charge (q)	10 nC
Bunch RMS length (σ)	0.5 mm
Accelerating gradient (E_z)	85.8 MV/m

WAKEFIELD DRIVEN BY SHAPED BUNCHES

- Shaped bunches simulated to estimate expected gradient and transformer ratio
- One promising bunch form is doorstep distribution (bottom)
- Compared to Gaussian distribution, has similar gradient but higher transformer ratio (4.73 vs. 1.98)

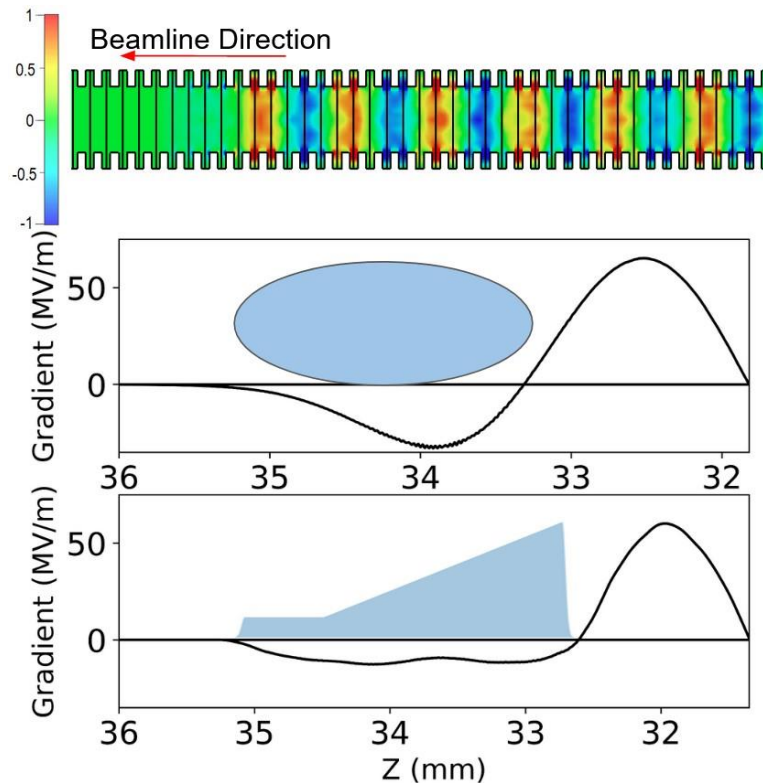
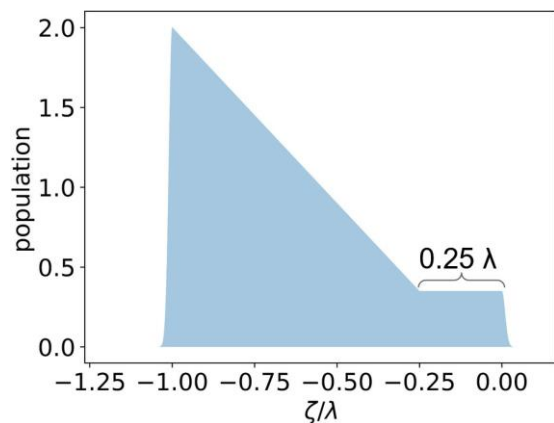

INSTALLATION

- Structure fabricated (right) and installed in vacuum chamber after EEX (bottom left)

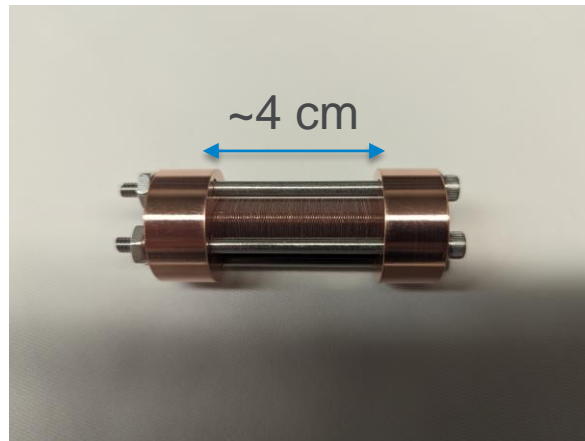
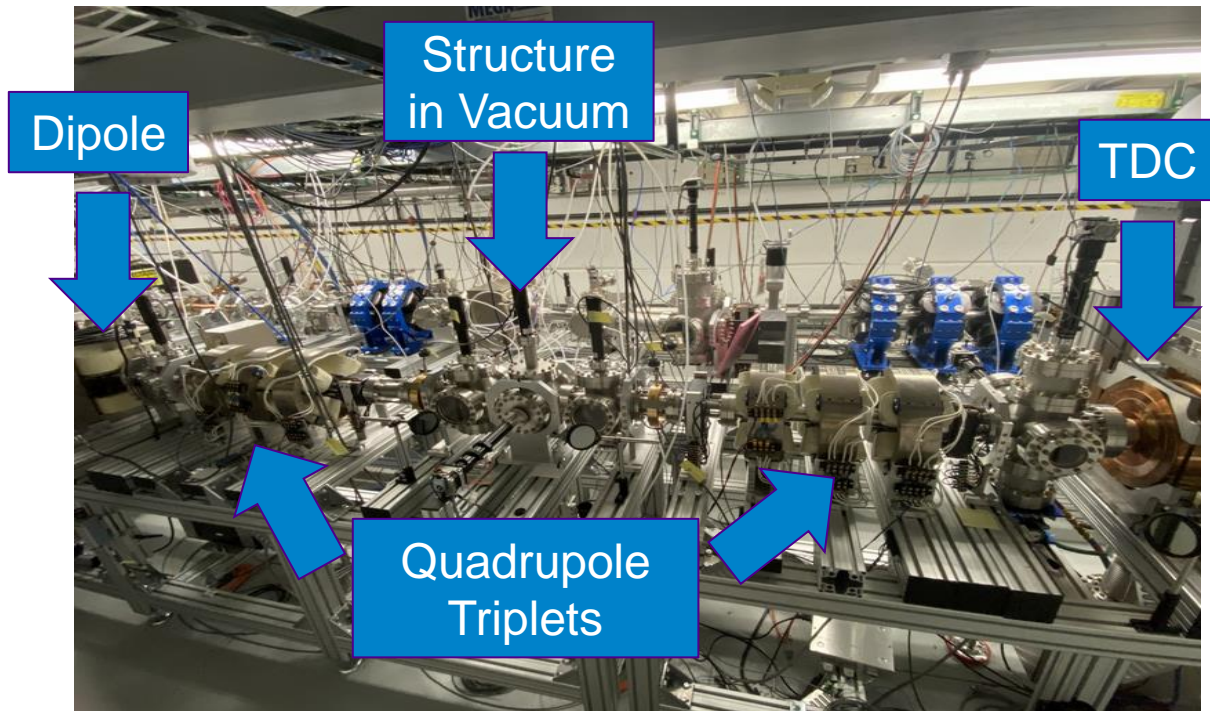

BEAMLINE DESIGN FOR TWO CASES

- EEX beamline simulated in Impact-T for two cases
 - Single high charge, short bunch (top) for high gradient
 - Two-bunch case with a shaped drive bunch (bottom) for high transformer ratio

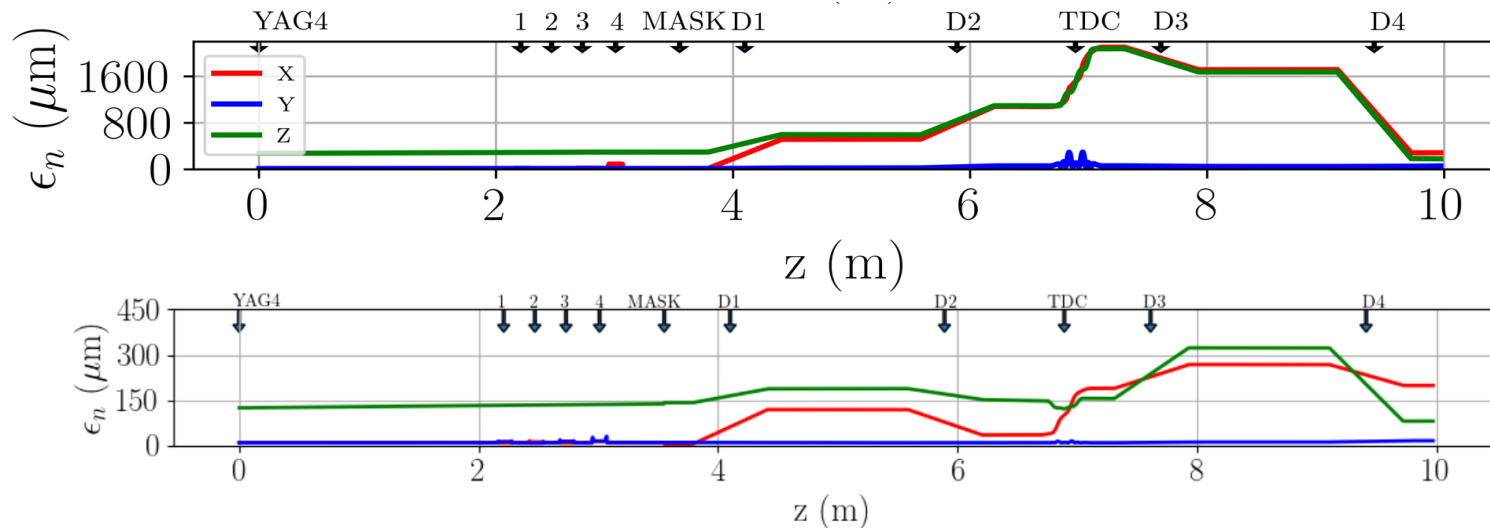

SINGLE BUNCH RESULTS FOR HIGH GRADIENT

- Single 6 nC bunch sent through EEX beamline
- Lower bound of energy spectrum measured without structure (left) and with structure (right) to show energy loss.
- Maximum decelerating gradient estimated to be about 60 MV/m

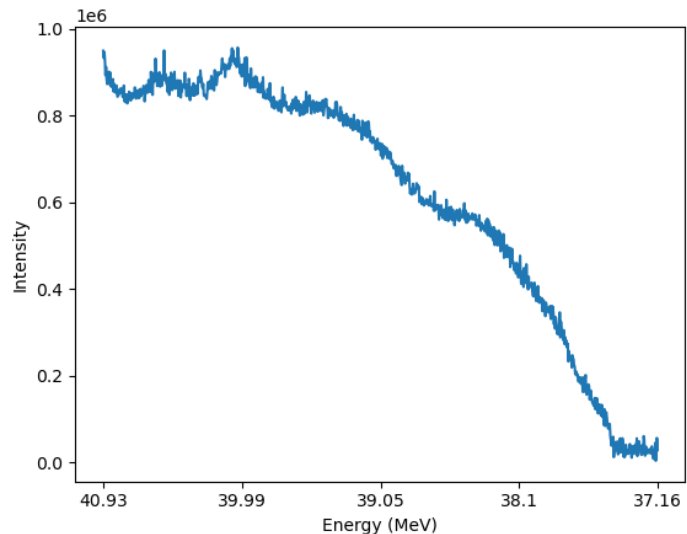
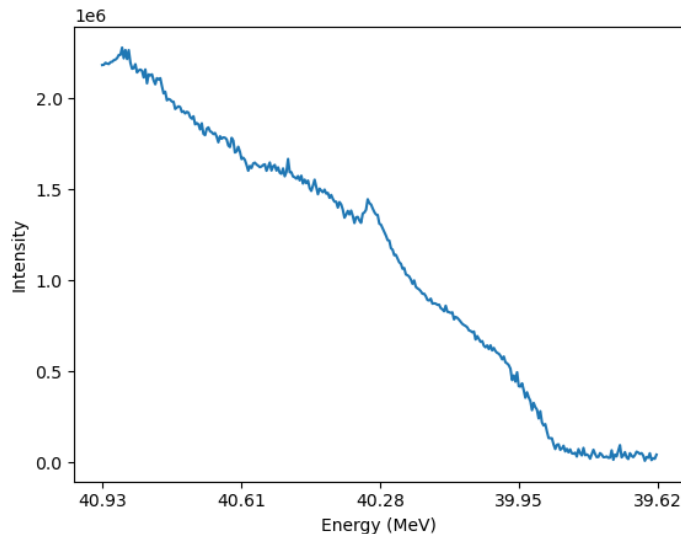

GENERATION OF SHAPED BUNCHES

- Current masks at AWA create triangular distributions
- Transverse phase space measured before EEX, longitudinal phase space measured after LPS with resultant drive bunch of 2 nC

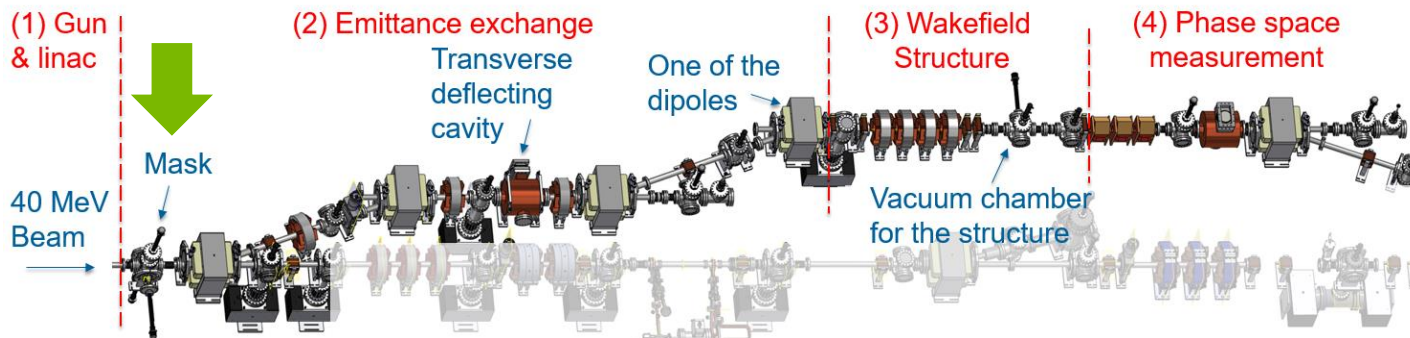
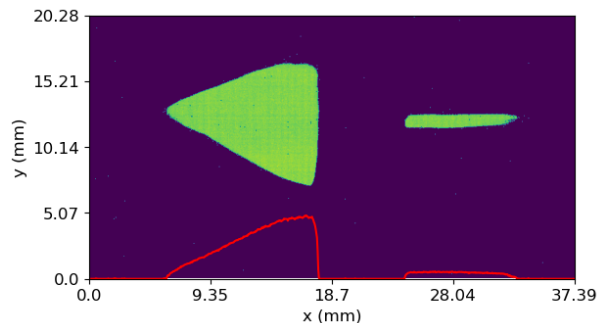
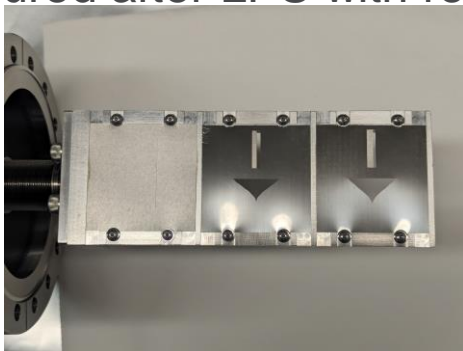

TWO-BUNCH EXPERIMENTAL RESULTS

- Two resultant bunches sent through both an aperture (left) and structure (right), and LPS measured
- Slit used to improve energy resolution
- Distinct gradient visible in drive bunch and witness bunch

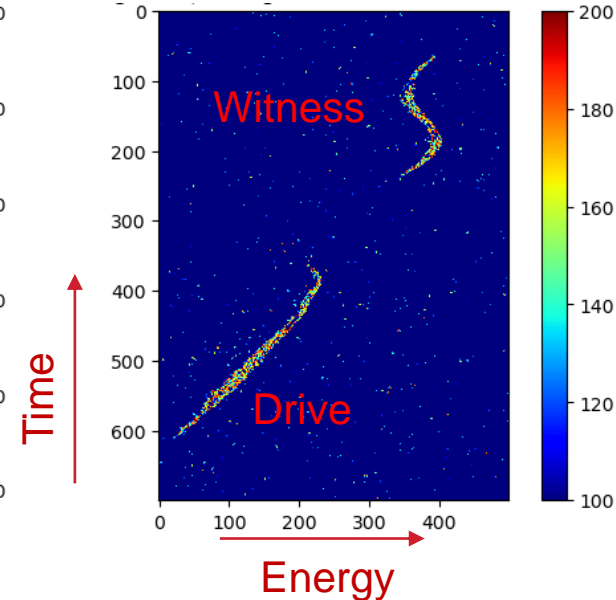
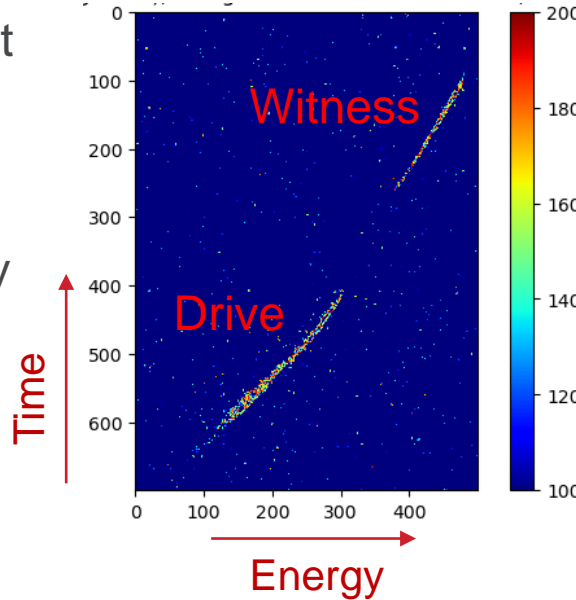

CONCLUSIONS

- 110 GHz structure successfully designed and installed in EEX beamline at AWA
- Longitudinal bunch shaping with mask and EEX beamline realized and shaped two bunch train passed through said structure.
- High charge single and shaped double bunch results observed
 - Decelerating gradient of about 60 MV/m seen for single bunch
 - Clear wakefield effect seen for two-bunch case

ACKNOWLEDGEMENTS

NIU:

- X. Lu
- Z. Sheemanto
- G. Rijal
- O. Ramachandran
- D. Merenich
- C. Phillips
- S. Colmekci

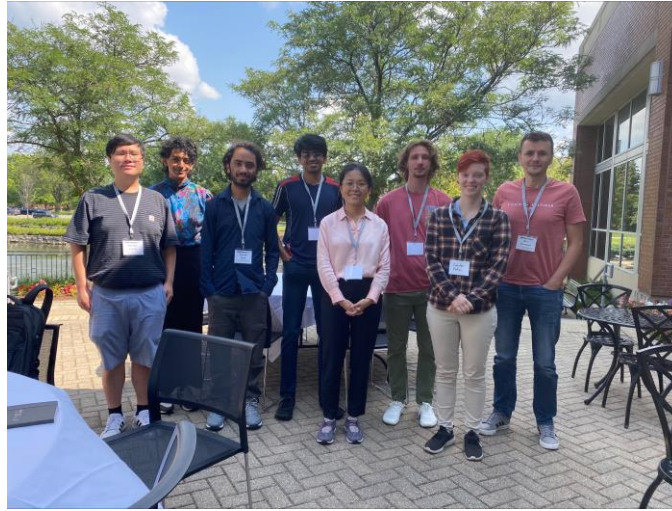

- This research was supported by the U.S. Department of Energy, Office of Science, Office of High Energy Physics under Award DE-SC0022010 and DE-SC0021928. The work at the AWA was funded through the U.S. Department of Energy, Office of Science under Contract No. DE-AC02-06CH11357.

AWA:

- J. Power
- S. Doran
- G. Chen
- W. Liu
- R. Margraf-O'Neal
- C. Jiang
- A. Ody
- P. Piot
- C. Whiteford
- E. Wisniewsky

Questions

EXPERIMENTAL RESULTS

- Shown here are results possible with the LPS from two bunch case utilizing the mask

