ECAL WG status report

Antonio Di Domenico

Dipartimento di Fisica, Sapienza Università di Roma
and INFN-Roma, Italy



Daniilo Domenici

INFN-LNF, Frascati, Italy

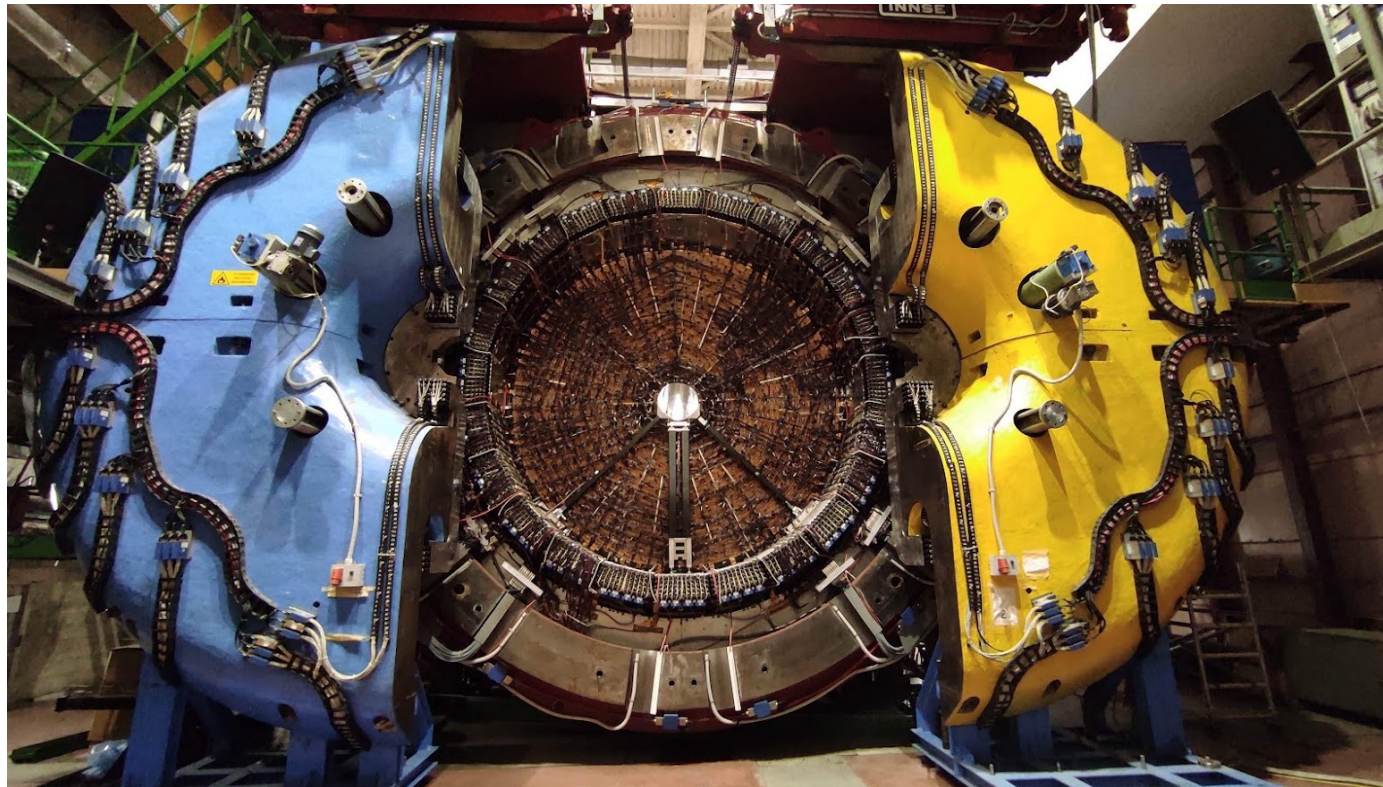

SAND ECAL WG Meeting – 15th April 2024





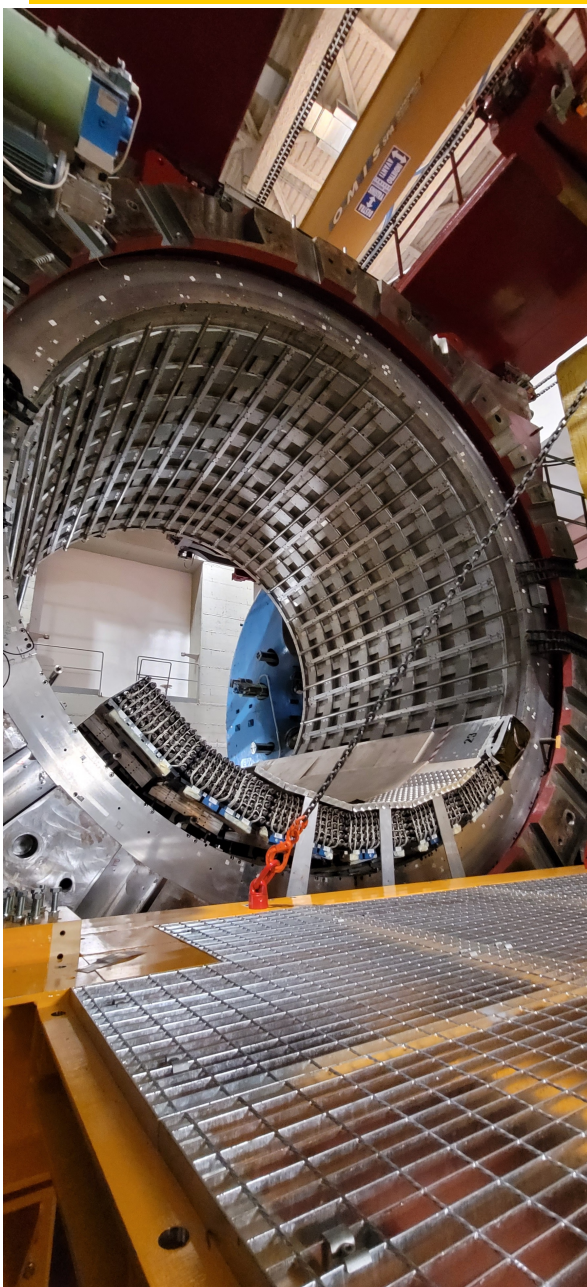

17 barrel modules dismantled
7 remaining

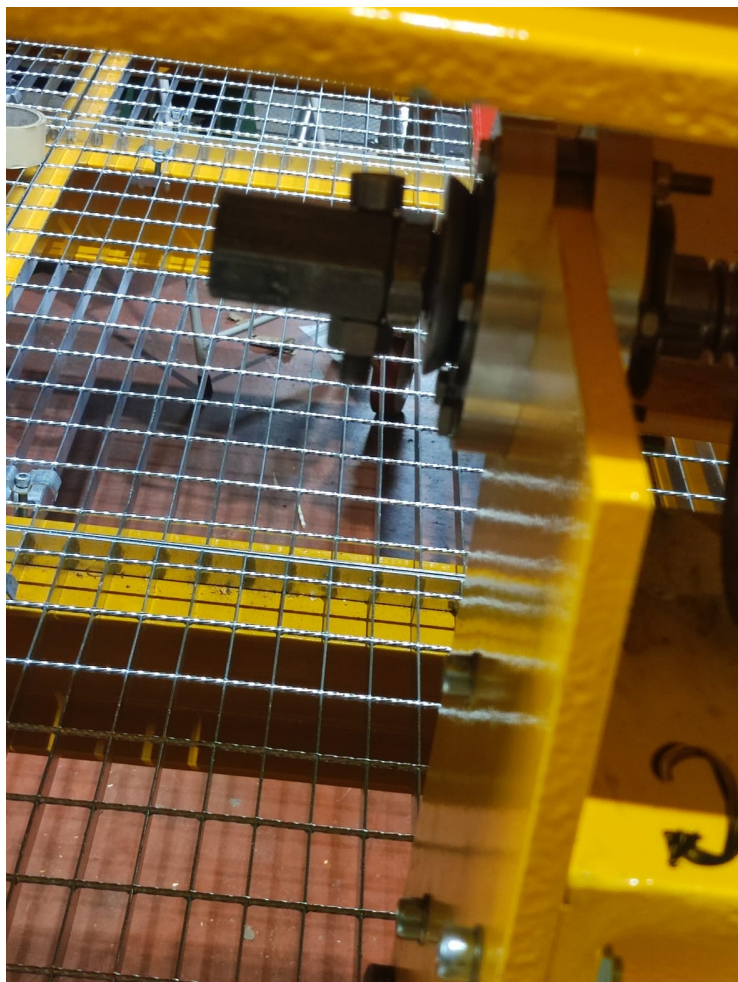
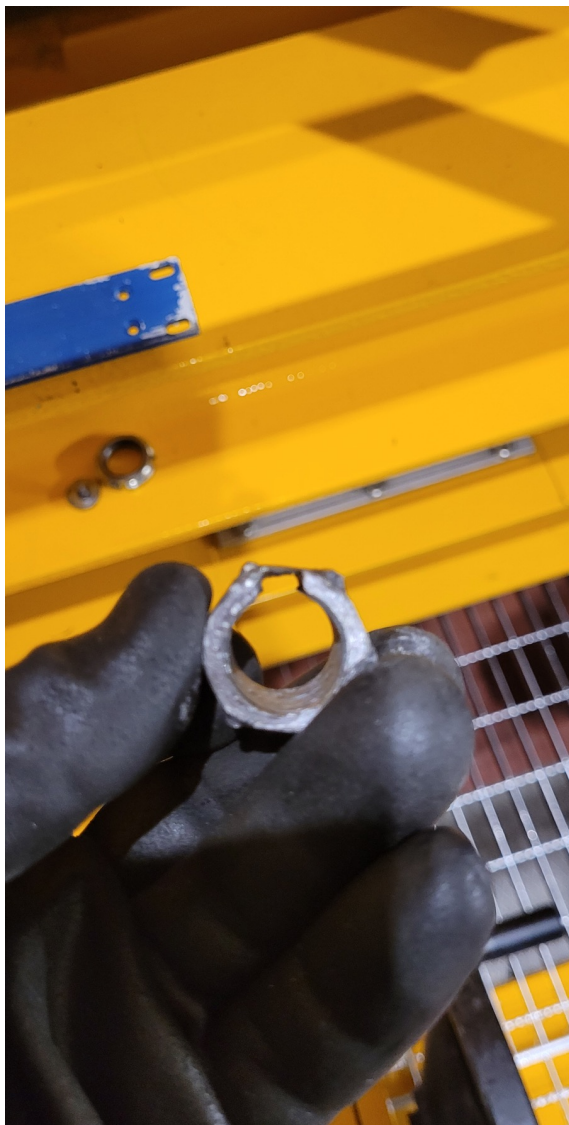

Dismounting of End-cap modules

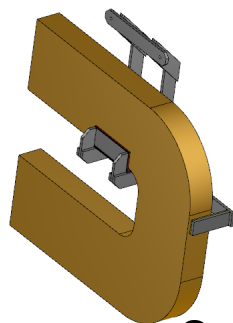
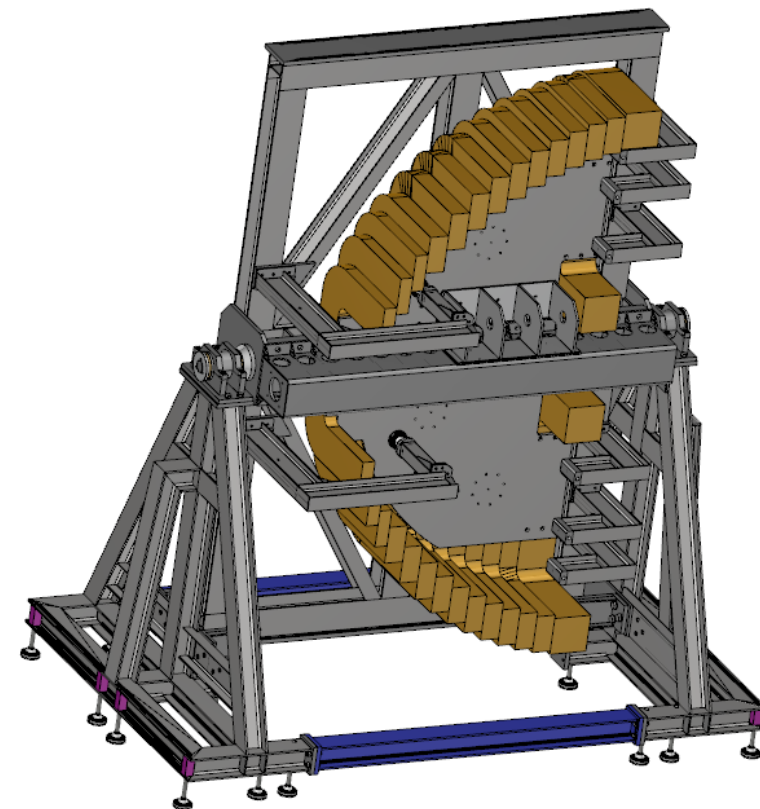
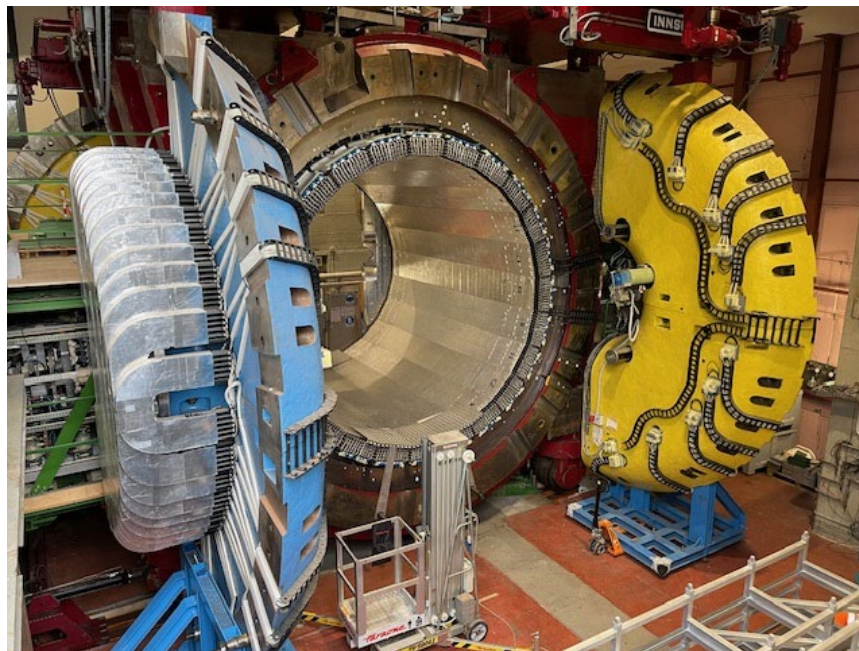
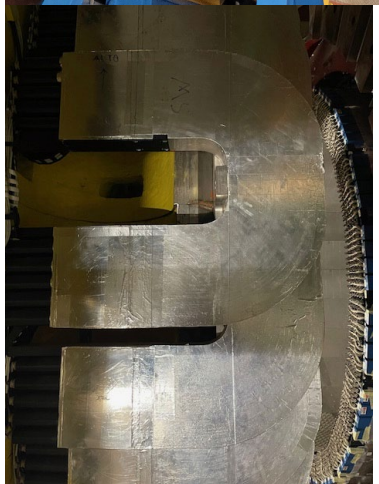
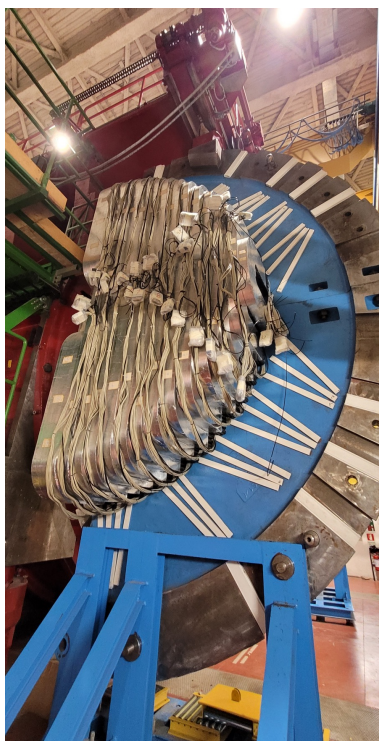

Special tool for dismounting the smallest module built and ready.

Design of supports for handling and transportation of each half End-cap completed

F. Noto – INFN LNS

Dismounting of End-cap modules

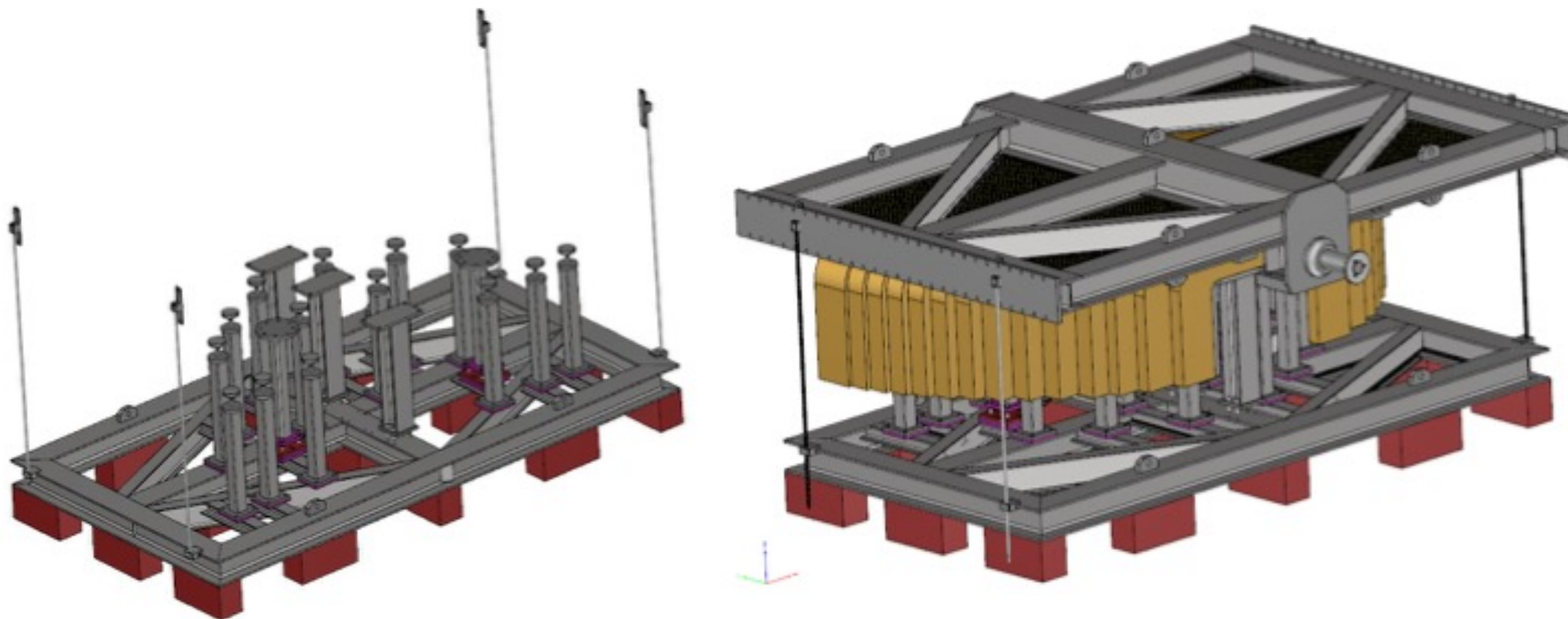

Design of supports for handling and transportation of each half End-cap completed

Order done, construction started.

Dismounting End-Cap modules foreseen by April-May 2024

F. Noto – INFN LNS





25-26-27-28 marzo

Alessandro Miccoli (LE)
Salvatore Maggiore (LE)
Massimo Nuccetelli (RM1)

3-4-5 aprile

Giulio Pancaldi (BO)
Francesco Noto (LNS) -> controlli saldature su tools endcaps

8-9-10-11-12 aprile

Mariani Filippo (PI)
Mirko Marinari (PI)
Filippo Vercellati (PV)
Samuel Gigli (PV)

15-16-17-18-19 aprile

Giulio Pancaldi (BO)
Michele Furini (BO)