



Modeling Athermal Phonons in Novel Materials using the G4CMP Simulation Toolkit

Israel Hernandez^{1,2}, Rakshya Khatiwada^{1,2,3} and Ryan Linehan³

¹Illinois Institute of Technology, ²Quantum Science Center and ³Fermilab

NEW PERSPECTIVES 2024

07/08/2024



Outline

1. Addition of New Materials in G4CMP
2. Phonon Caustics: what do we need to model, then how do we validate?
3. Isotopic Scattering and Downconversion: what do we need to model, and how do we validate?
4. Density Of States: what do we need to model, and how do we validate?
5. Conclusions and Future

Addition of New Materials to G4CMP

What crystal parameters do we need to simulate phonon kinematics?

Parameter	Units	Description	Method to obtain parameters	Relevant Microphysics
C_{ij}	GPa	Second-order elastic constants	Experimental	Phonon Kinematics

Addition of New Materials to G4CMP

What crystal parameters do we need to simulate phonon kinematics?

Parameter	Units	Description	Method to obtain parameters	Relevant Microphysics
C_{ij}	GPa	Second-order elastic constants	Experimental	Phonon Kinematics
μ	GPa	Lamé constant, 2nd-order isotropic elastic constants	Theoretical or Experimental	Phonon Diffusion
λ	GPa	Lamé constant, 2nd-order isotropic elastic constants	Theoretical or Experimental	Phonon Diffusion
β	GPa	3rd-order isotropic elastic constant	Theoretical or Experimental	Phonon Diffusion
γ	GPa	3rd-order isotropic elastic constant	Theoretical or Experimental	Phonon Diffusion
A	s ⁴	Anharmonic downconversion coefficient	Theoretical or Experimental	Phonon Diffusion
B	s ³	Isotopic scattering coefficient	Theoretical or Experimental	Phonon Diffusion
F	None	Fraction of L->TT downconversion	Theoretical	Phonon Diffusion

Addition of New Materials to G4CMP

What crystal parameters do we need to simulate phonon kinematics?

Parameter	Units	Description	Method to obtain parameters	Relevant Microphysics
C_{ij}	GPa	Second-order elastic constants	Experimental	Phonon Kinematics
μ	GPa	Lamé constant, 2nd-order isotropic elastic constants	Theoretical or Experimental	Phonon Diffusion
λ	GPa	Lamé constant, 2nd-order isotropic elastic constants	Theoretical or Experimental	Phonon Diffusion
β	GPa	3rd-order isotropic elastic constant	Theoretical or Experimental	Phonon Diffusion
γ	GPa	3rd-order isotropic elastic constant	Theoretical or Experimental	Phonon Diffusion
A	s ⁴	Anharmonic downconversion coefficient	Theoretical or Experimental	Phonon Diffusion
B	s ³	Isotopic scattering coefficient	Theoretical or Experimental	Phonon Diffusion
F	None	Fraction of L->TT downconversion	Theoretical	Phonon Diffusion
LDOS	None	Longitudinal phonon's density of states (fractional)	Theoretical or Experimental	Energy partition
STDOS	None	Transverse slow phonon's density of states (fractional)	Theoretical or Experimental	Energy partition
FTDOS	None	Transverse fast phonon's density of states (fractional)	Theoretical or Experimental	Energy partition
Debye Energy	THz	Debye Energy for phonon primaries	Theoretical or Experimental	Maximum phonon Energy

Section 1: Ballistic phonon propagation

Phonon Kinematics

What do we need to properly model ballistic phonon kinematics?

Phonon Propagation

$$\rho\omega^2\epsilon_\mu = \sum_{\tau} \left(\sum_{\sigma\nu} c_{\mu\sigma\nu\tau} k_\sigma k_\nu \right) \epsilon_\tau,$$

crystal's mass density Elastic constant tensor polarization vector

phonon frequency phase velocity vector

At the ballistic regime, the propagation of phonon is governed by Green-Christoffel equation. To simulate ballistic phonons we need:

- Lattice parameters (dimensions of the unit cell).
- Crystal group.
- Value of the second elastic constants.
- Sound velocities: Longitudinal and Transverse.

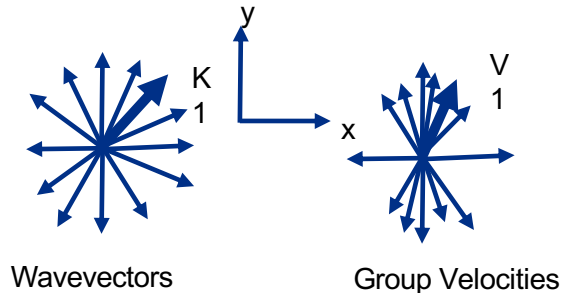

Ballistic phonons experiments and G4CMP

How can one validate the ballistic phonon propagation?

Experimental Setup from literature

Incident energy

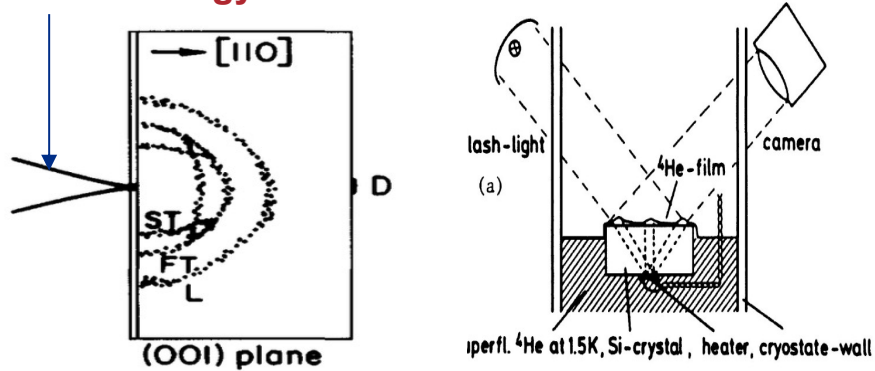

J. P. Wolfe, Imaging Phonons: Acoustic Wave Propagation in Solids, Cambridge University Press, 1998

- Triggering the signal to detect ballistic phonon and polarization.
- Photon source scan in XY plane.

G4CMP

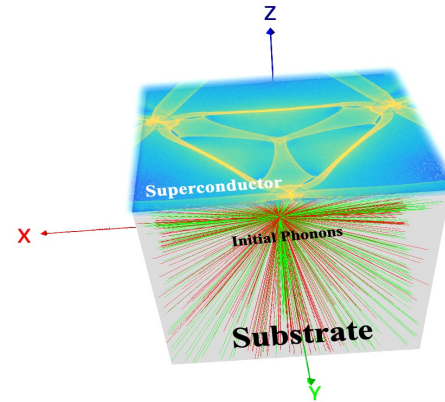

Rendering of G4CMP simulation: the gray box is the substrate (Sapphire), the red (transverse fast) and green (transverse slow) lines are the phonon trajectories.

Phonon Caustic in Novel Materials

We validate simulation with available experimental phonon caustics

G4CMP

Sapphire

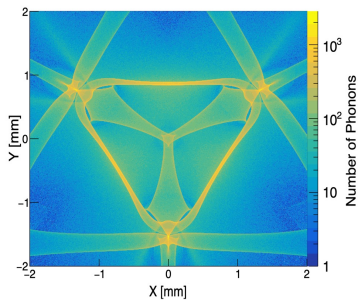

CaWO₄

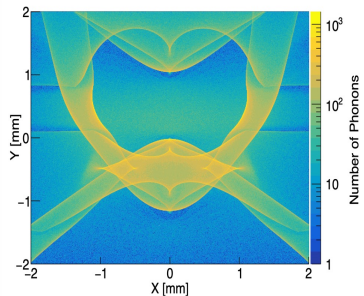

LiF

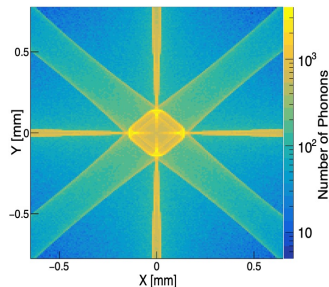

GaAs

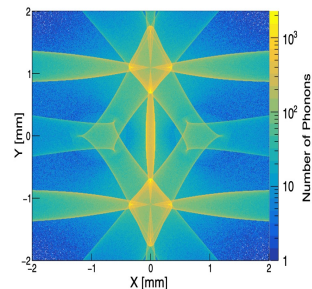

CaF₂

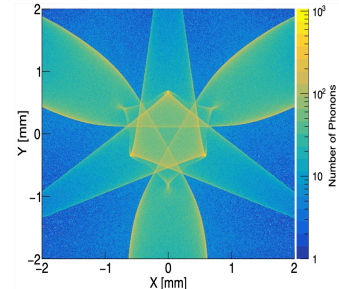

Experimental

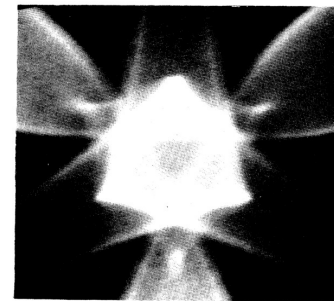
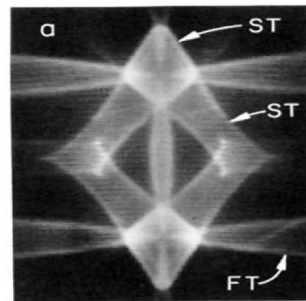
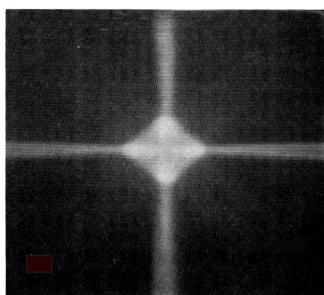
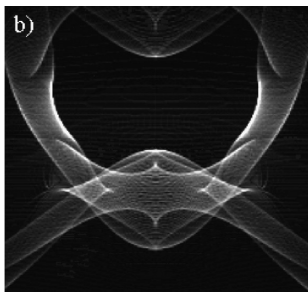
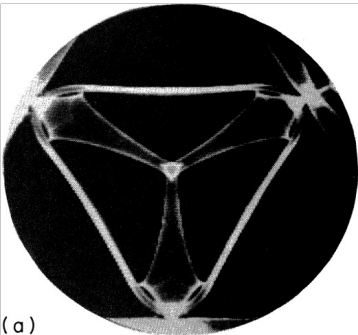

Section 2: Downconversion and Isotopic Scattering

Anharmonic Downconversion Rate and Lamé Parameters in G4CMP

Tamura's Model

Downconversion rate

$$\Gamma_{LA \rightarrow LA+TA} = \frac{\hbar}{256\pi\rho^3} \frac{\delta^2 - 1}{v_l^9} (2\beta + 4\gamma + \lambda + 3\mu)^2 \times \int_{x_0}^1 \frac{dx}{x^2} (1-x^2)^2 [(1+x^2)^2 - \delta^2(1-x^2)^2][1+x^2 - \delta^2(1-x^2)^2]^2 \omega^5$$

Lamé parameters

$$\Gamma_{LA \rightarrow TA+TA} = \frac{\hbar}{32\pi\rho^3} \frac{1}{(v_l v_t)^3} \times$$

$$\int_{x_1}^{x_2} \left\{ (H + B\delta x - Bx^2)^2 + \left[Cx(\delta - x) - \frac{D}{\delta - x} \left(x - \delta - \frac{1 - \delta^2}{4x} \right) \right]^2 \right\} \omega^5$$

H, B, C and D depends on Lamé parameters

Tamura, Spontaneous decay rates of the phonons 1038 in quasi-isotropic solids, Phys. Rev. B 31 (1985) 2574–1039 2577

G4CMP needs the Lamé parameters to estimate the partition energy of the daughter phonons.

Tamura's model:

- Isotropic continuum model, independent of the crystal direction and phonon direction
- Representation of the potential as function of the Lamé parameters.

Issues

- Hard to find experimental values for all Lamé parameters.
- In literature only theoretical calculation for cubic crystal group available.

Lamé Parameters Calculation

We obtain the Lamé parameter as function of the second and third order-elastic constants following procedure propose by Tamura¹

$$\mu = (3C_{iklk} - C_{lkk})/30$$

$$\lambda = (2C_{iklk} - C_{lkk})/15$$

$$\alpha = (3C_{iillmn} - 15C_{iilnlm} + 8C_{inillm})/105$$

$$\beta = (-5C_{iillmn} + 19C_{iilnlm} - 12C_{inillm})/210$$

$$\gamma = (2C_{iillmn} - 9C_{iilnlm} + 9C_{inillm})/210$$

Depending on the crystal group symmetries these equations can be reduced.

Now, we have the general expression for any crystal group!

[1] Tamura, Spontaneous decay rates of la phonons 1038 in quasi-isotropic solids, Phys. Rev. B 31 (1985) 2574– 1039 2577

Anharmonic Downconversion Rates

Calculating the Anharmonic Scattering rate following Tamura's process for novel materials

Material	μ [GPa]	λ [GPa]	α [GPa]	β [GPa]	γ [GPa]	F_{TT}	A [10^{-55} s^4]	$A_{c,1}$ [10^{-55} s^4]	$A_{m,1}$ [10^{-55} s^4]
Si	68.58	53.68	-227.37	-55.97	-107.97	0.75	1.15	0.741	N/A
Ge	56.0	37.6	-181.8	-61.0	-81.6	0.72	6.8	16.5	N/A
GaAs	44.2	47.2	-170.11	-54.71	-67.51	0.77	7.77	7.7-13.5	N/A
Al ₂ O ₃	166.24	139.8	95.13	-27.02	-152.8	0.67	12.7	0.30	N/A
LiF	51.51	30.72	-84.74	-83.94	-87.54	0.54	5.16	5.14	N/A
CaWO ₄	40.78	57.94	-306	61.2	-37.7	0.81	14.4	16-140	N/A
CaF ₂	45.15	65.2	-211.96	-98.92	-58.2	0.75	5.3	7.0-10.4	9.3

Preliminary

The table shows our calculated values A , the calculated values obtained from the literature $A_{c,1}$ and the experimental measurements $A_{m,1}$.

Isotopic Downconversion Rate

Isotopic downconversion rate, isotropic approximation

$$\Gamma(md) = \frac{\Gamma_{md}\Omega}{4\pi\langle c \rangle^3} \omega^4$$

Γ_{md} mass isotope scattering defect.

Ω Volume per atom

$$1/\langle c \rangle^3 = 1/c_L^3 + 1/c_{TF}^3 + 1/c_{TS}^3$$

Average cubed speed

Mass isotope scattering defect Γ_{md} depends on the number of isotopes and the abundance.

Volume per atom depends on the experimental measurements of the dimension of the unit cell.

Average cubed speed $1/\langle c \rangle^3$ depends on the direction of propagation.

Isotopic Downconversion

Calculating scattering rates using the isotropic approximation on novel material

Material	$\Omega [A^3]$	Γ_{md}	$\langle c^3 \rangle$ [10 ¹¹ m ³ /s ³]	B [10 ⁻⁴² s ³]	$B_{c,1}$ [10 ⁻⁴² s ³]	$B_{m,1}$ [10 ⁻⁴² s ³]
Si	2.0	2.02×10^{-4}	2.13	2.61	2.42	2.42-2.56
Ge	2.26	5.88×10^{-4}	0.46	35.4	36.7	N/A
GaAs	2.38	9.16×10^{-5}	0.479	7.02	7.38	5.9-29.5
Al ₂ O ₃	0.5	1.25×10^{-5}	3.06	0.025	N/A	0.04
LiF	0.81	1.36×10^{-4}	1.19	1.17	1.69	N/A
CaWO ₄	1.3	2.02×10^{-4}	0.22	14.6	2.4-59	N/A
CaF ₂	1.4	1.83×10^{-4}	0.84	3.75	9.13	20.3

Preliminary

The table shows our calculated values B , the calculated values obtained from the literature $B_{c,1}$ and the experimental measurements $B_{m,1}$.

Experimental Measurements from Literature

Several methods are available to measure the isotopic scattering rate:

- Thermal conductivity measurements [1].
- Phonon backscattering technique [2].
- Phonons are scattered around a slot cut into the chip under test [3].

For Anharmonic decay rate, fewer techniques in the literature

- Optical technique with a tunable dopant [4].

Example of Isotopic Scattering Rate (slot cut)

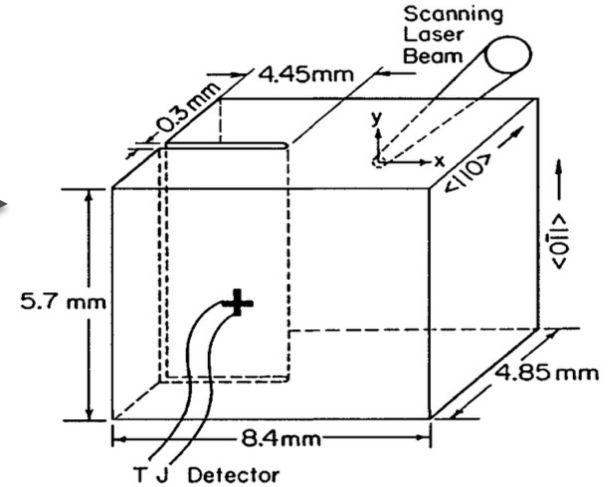

- [1] J. A. Harrington, C. T. Walker, Phonon scattering by 1165 point defects in CaF_2 , SrF_2 , and BaF_2 , Phys. Rev. B 1 1166 (1970) 882–890
[2] J. Wigmore, A. Kozorezov, H. bin Rani, M. Giltrow, H. Kraus, B. Taelle, Scattering of the phonons, Physica B: Condensed Matter 316-317 (2002) 589–591, proceedings of the 10th International Conference on Phonon Scattering in Condensed Matter.
[3] S. Tamura, J. Shields, M. Ramsbey, J. Wolfe, Measurements of phonon elastic scattering rates by phonon 1148 imaging and monte-carlo simulation, in: Phonon Scattering in Condensed Matter VII: Proceedings of the 1150 Seventh International Conference, Cornell University, 1151 Ithaca, New York, August 3–7, 1992, Springer, 1993, 1152 pp. 79–83.
[4] R. Baumgartner, M. Engelhardt, K. F. Renk, Spontaneous decay of high-frequency acoustic phonons in CaF_2 , Phys. Rev. Lett. 47 (1981) 1403–1407

J. P. Wolfe, Imaging Phonons: Acoustic Wave Propagation in Solids, Cambridge University Press, 1998

Section 3: Density of States

Fractional Density of States

How can we obtain the fractional density of states?

Need to use a program to calculate the fractional density of states L:TF:TS to know the initial population of longitudinal and transverse phonon after energy deposition.

Several programs exist to calculate the DOS.

- Quantum Espresso
www.quantum-espresso.org
- Phonopy
phonopy.github.io/phonopy/
- VASP
www.vasp.at
- BIOVIA Material Studio
www.3ds.com/products/biovia/materials-studio

All the previous programs only provide the total density of states.

Using Quantum espresso we obtain the wave dispersion curve and apply the following equation :

density of state phonon frequencies

$$g(\omega) = \frac{1}{N} \sum_{\lambda} \delta(\omega - \omega_{\lambda})$$

number of unit cells $\lambda = (\nu, \mathbf{q})$ ν as the band index and \mathbf{q} as the q-point

Fractional Density of State and Debye Energy

Using the wave dispersion curve we can obtain the DOS

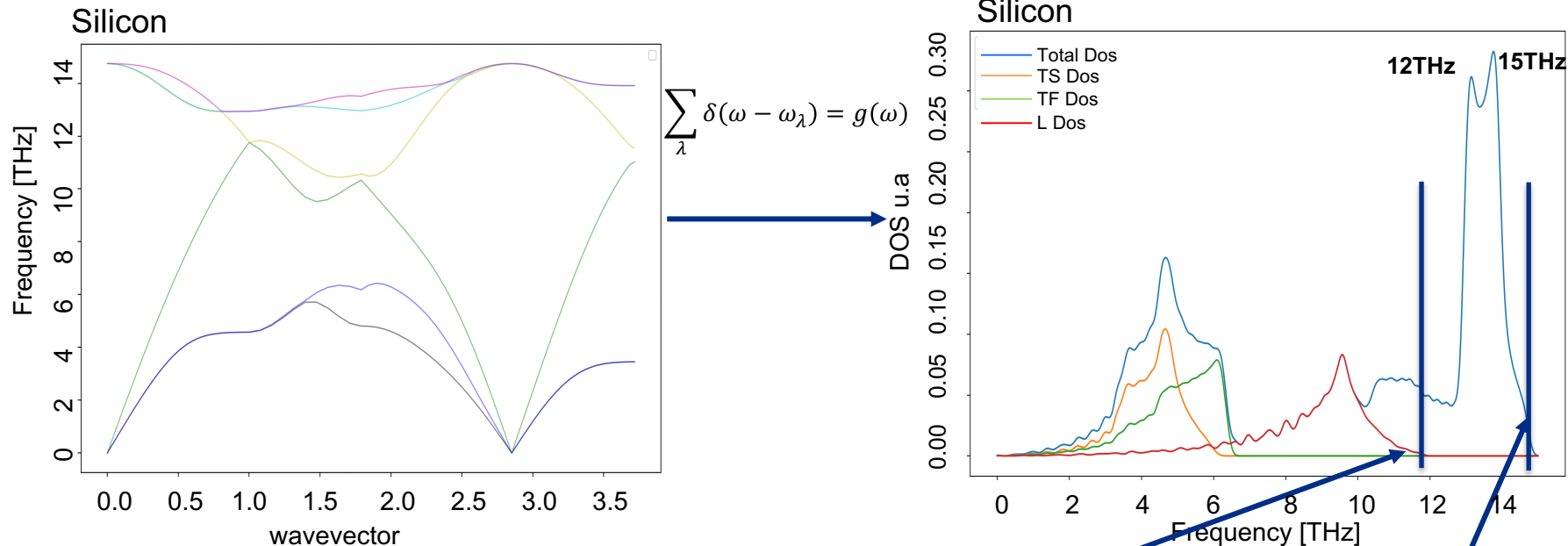

Building the density of states we can obtain:

- Fractional LS:TS:TF at any energy .
- Debye energy .

Maximum phonon energy
for acoustic phonons

Debye Energy for optical
phonons

Fractional Density of State and Debye Energy

Using phonopy we obtain the fractional DOS and the Debye energy

Material	TS:TF:L	ω_A [THz]	ω_O [THz]	ω_{OE} [THz]
Si	0.521 : 0.406 : 0.071	12.14	15.28	15.5
Ge	0.535 : 0.366 : 0.097	6.63	9.02	9.02
GaAs	0.585 : 0.379 : 0.036	6.45	8.15	8.82
Al ₂ O ₃	0.511 : 0.351 : 0.137	8.41	26.29	26.35
LiF	0.5156 : 0.386 : 0.0983	10.73	18.19	19.7
CaF ₂	0.599 : 0.318 : 0.0819	7.55	13.65	13.67
CaWO ₄	—	2.89	25.62	25.62

Preliminary

Al₂O₃

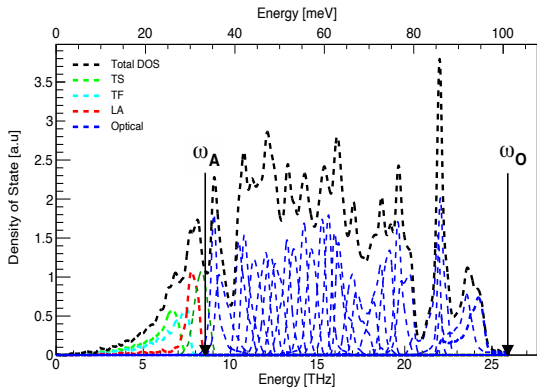

CaF₂

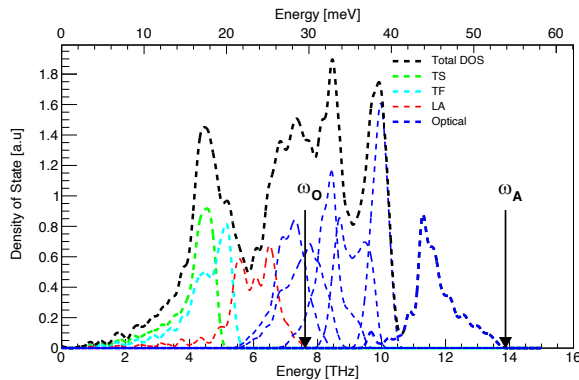

LiF

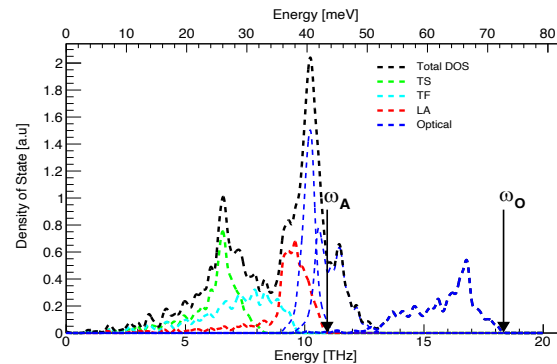

Conclusions and Future

G4CMP has limitations in the implementation of phonon physics. For low energy events, a complete understanding of phonon physics is essential which can only be achieved with the following:

1. Incorporate more sophisticated phonon physics on G4CMP
2. Validation of parameters.
 - 2.1. Experimental measurements
 - a. Scattering rates estimates.
 - 2.2. Using G4CMP
 - a. Ballistic phonon propagation.
 - b. Density of states.

We've now expanded the range of materials we can model in G4CMP, which enables us to simulate energy depositions in sapphire qubit chips (subject of a future talk!).

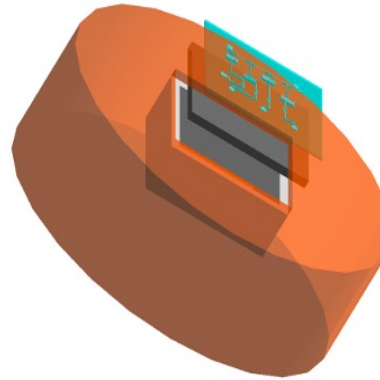

Rendering of 4-qubit chip geometry with sapphire substrate

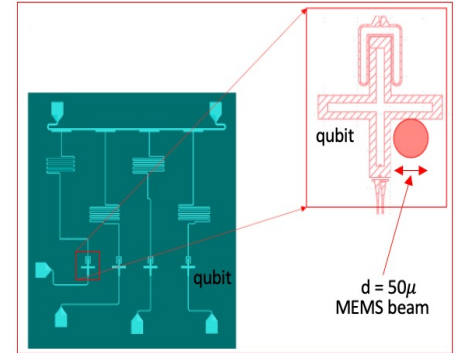

Simulating photon absorption

Summary

We expanded the G4CMP capability by incorporating novel materials (paper coming soon!)

We discuss the limitation and new challenges for G4CMP

Future

- Experimentally validate the phonon parameters.
- Our paper summarizes this toolkit for adding an arbitrary new material
- Our toolkit's results for novel materials will be coming out in G4CMP main branch https://github.com/Israel-Tanjiro/Sapphire_G4CMP

Acknowledgements



Funding: This material is based upon work supported by the U.S. Department of Energy, Office of Science, National Quantum Information Science Research Centers and Illinois Institute of Technology. FERMILAB-SLIDES-23-354-V

Collaborators

QSC@FNAL:

Rakshya Khatiwada
Ryan Linehan
Lauren Hsu
Daniel Baxter
Daniel Bowring
Kester Anyang
Jialin Yu
Dylan Temples
Sara Sussman
Stella Dang
Gustavo Cancelo
Sho Uemura
Sami Lewis
Stella Dang
Matthew Hollister
Chris James
Grace Wagner

Northwestern:

Enectali Figueroa

SLAC:

Noah Kurinsky
Kelly Stifter
Hannah Magoon
Sukie Kevane

QSC@Purdue

Alex Ma
Botao Du

Texas A & M:

Michael Kelsey.

UW Madison

Robert McDermott
Sohair Abdullah

Phonon Caustics References

Sapphire

A. G. Every, G. L. Koos, J. P. Wolfe, Ballistic phonon 1170 imaging in sapphire: Bulk focusing and critical-cone 1171 channeling effects, Phys. Rev. B 29 (1984) 2190–2209.

CaWO₄

G. A. Northrop, S. E. Hebboul, J. P. Wolfe, Lattice 1182 dynamics from phonon imaging, Phys. Rev. Lett. 55 1183 (1985) 95–98. doi:10.1103/PhysRevLett.55.95.

LiF

G. A. Northrop, E. J. Cotts, A. C. Anderson, 1187 J. P. Wolfe, Phonon imaging of highly dis- 1188 located lif, Phys. Rev. Lett. 49 (1982) 54–57.

GaAs

G. A. Northrop, S. E. Hebboul, J. P. Wolfe, Lattice 1182 dynamics from phonon imaging, Phys. Rev. Lett. 55 1183 (1985) 95–98

CaF₂

S. M. Griffin, K. Inzani, T. Trickle, Z. Zhang, K. M. Zurek, Multichannel direct detection of light dark mat- ter: Target comparison, Phys. Rev. D 101 (5) (2020) 055004.

https://github.com/Israel-Tanjiro/Sapphire_G4CMP

Lamé Parameters Calculation

How do we obtain the theoretical values of the Lamé parameters?

We follow the same procedure propose by Tamura, minimizing the quantity

$$f = \sum (C_{ijklmn}^R - C(\alpha, \beta, \gamma)_{ijklmn})^2,$$

to obtain the Lamé parameter as function of the second and third order-elastic constants (experimental values C_{ijklmn}^R).

We obtain the following general expressions:

$$\mu = (3C_{lklk} - C_{llkk})/30$$

$$\lambda = (2C_{lklk} - C_{llkk})/15$$

$$\alpha = (3C_{iillnn} - 15C_{iilnln} + 8C_{inilln})/105$$

$$\beta = (-5C_{iillnn} + 19C_{iilnln} - 12C_{inilln})/210$$

$$\gamma = (2C_{iillnn} - 9C_{iilnln} + 9C_{inilln})/210$$

Depending on the crystal group symmetries the previous equation can be reduced.

Now, we have the general expression for any crystal group!

Experimental Measurement from Literature

We need to compare the Quantum espresso results with experimental measurements of the wave dispersion curve and density of states .

Examples of computed wave dispersion curves and DOS with Inelastic Neutron Scattering measurements

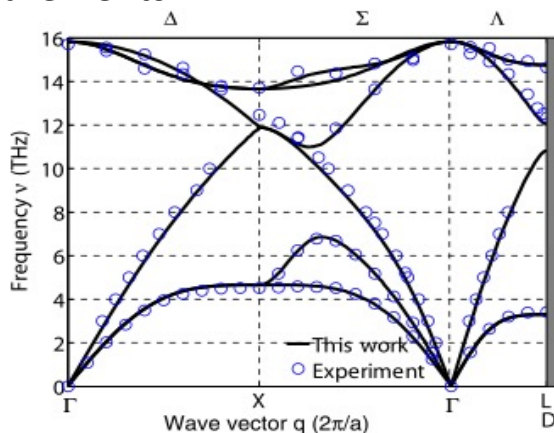

Calculated phonon dispersion (black solid line) for bulk silicon compared to experiment (blue circles).

[1] Valentin, Audrey & Sée, Johann & Galdin-Retailleau, Sylvie & Dollfus, Philippe. (2008). Study of phonon modes in silicon nanocrystals using the adiabatic bond charge model. J. Phys.: Condens. Matter. 20.

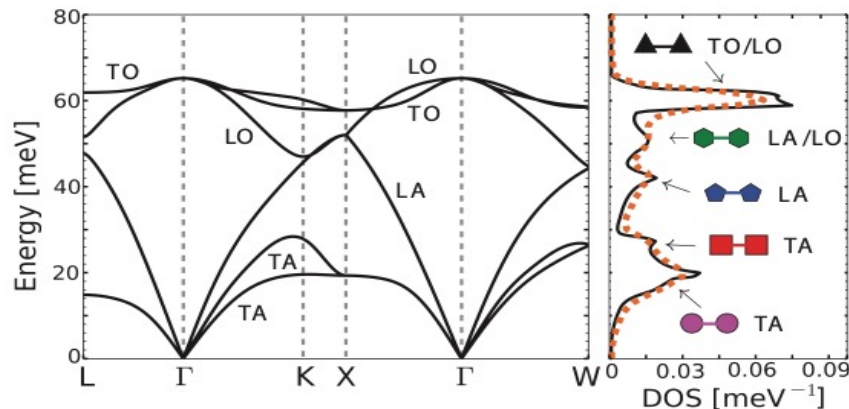

Phonon dispersion and DOS of silicon: calculated (black solid line), experimental (orange dotted line).

[2] Jiří Kulda, Dieter Strauch, Pasquale Pavone, and Yoshinobu Ishii. Inelastic-neutron-scattering study of phonon eigenvectors and frequencies in Si. Phys. Rev. B 50, 13347 – Published 1 November 1994