

Single Cavity Assembly

Ryan Schultz

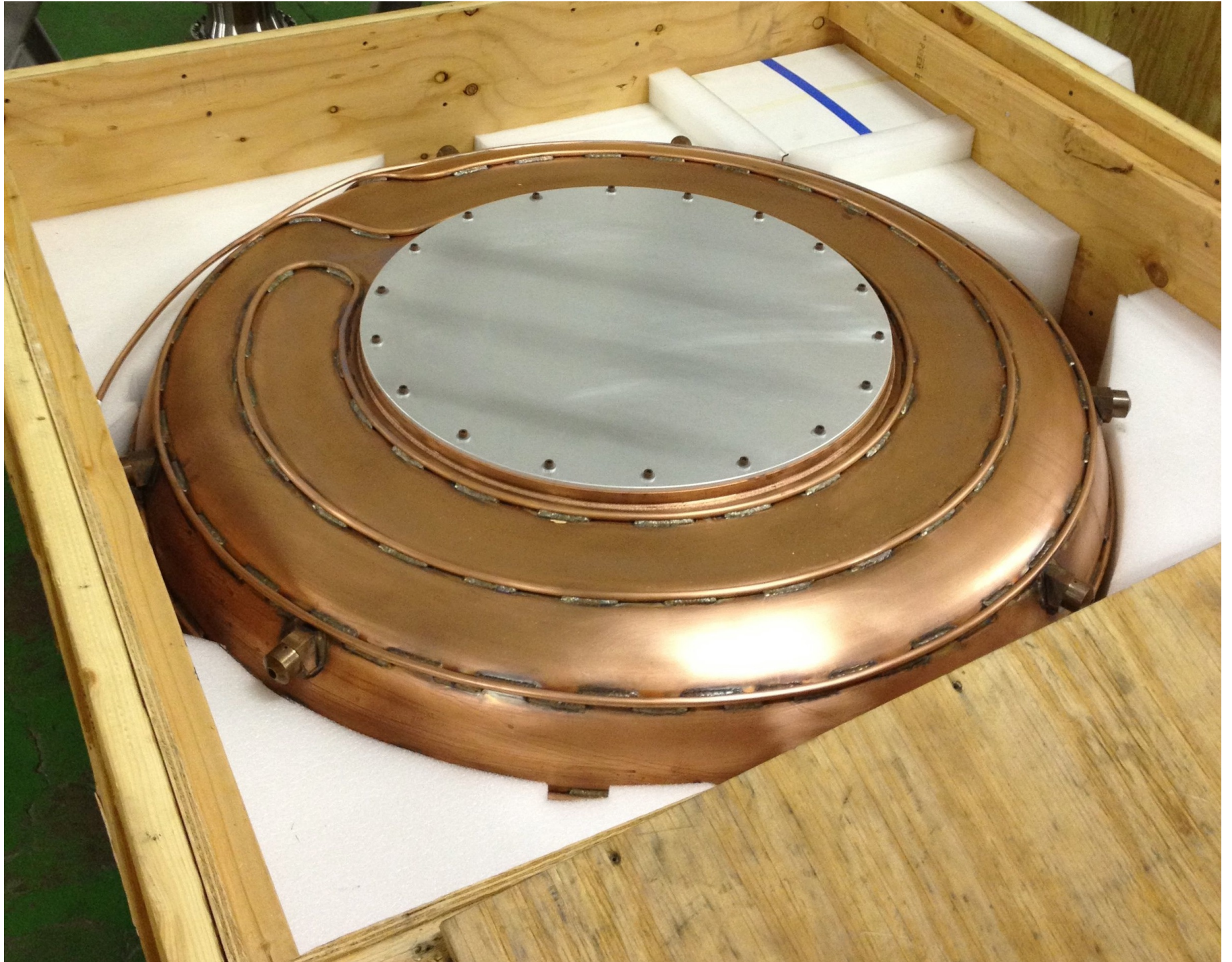

June, 2012



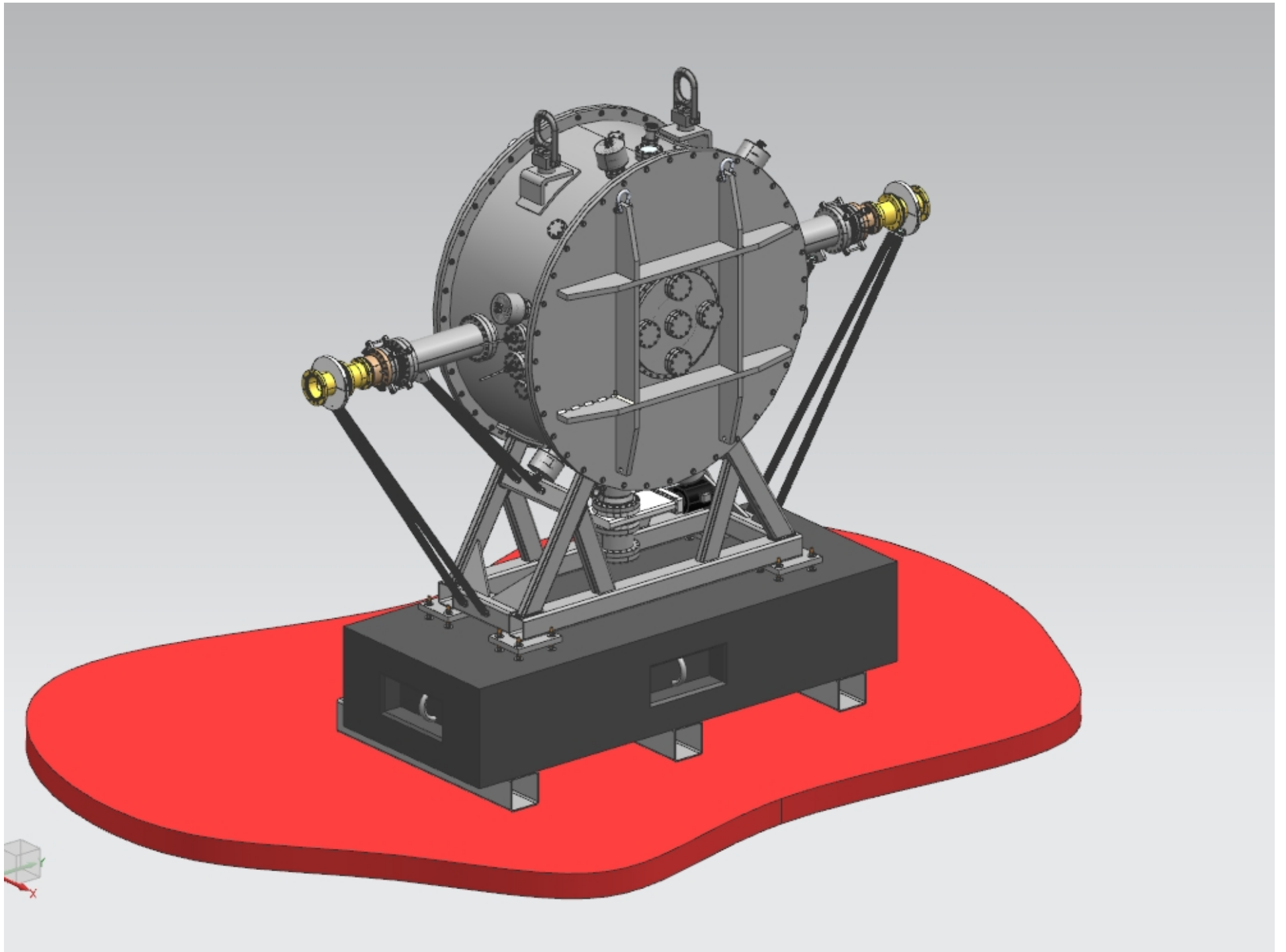

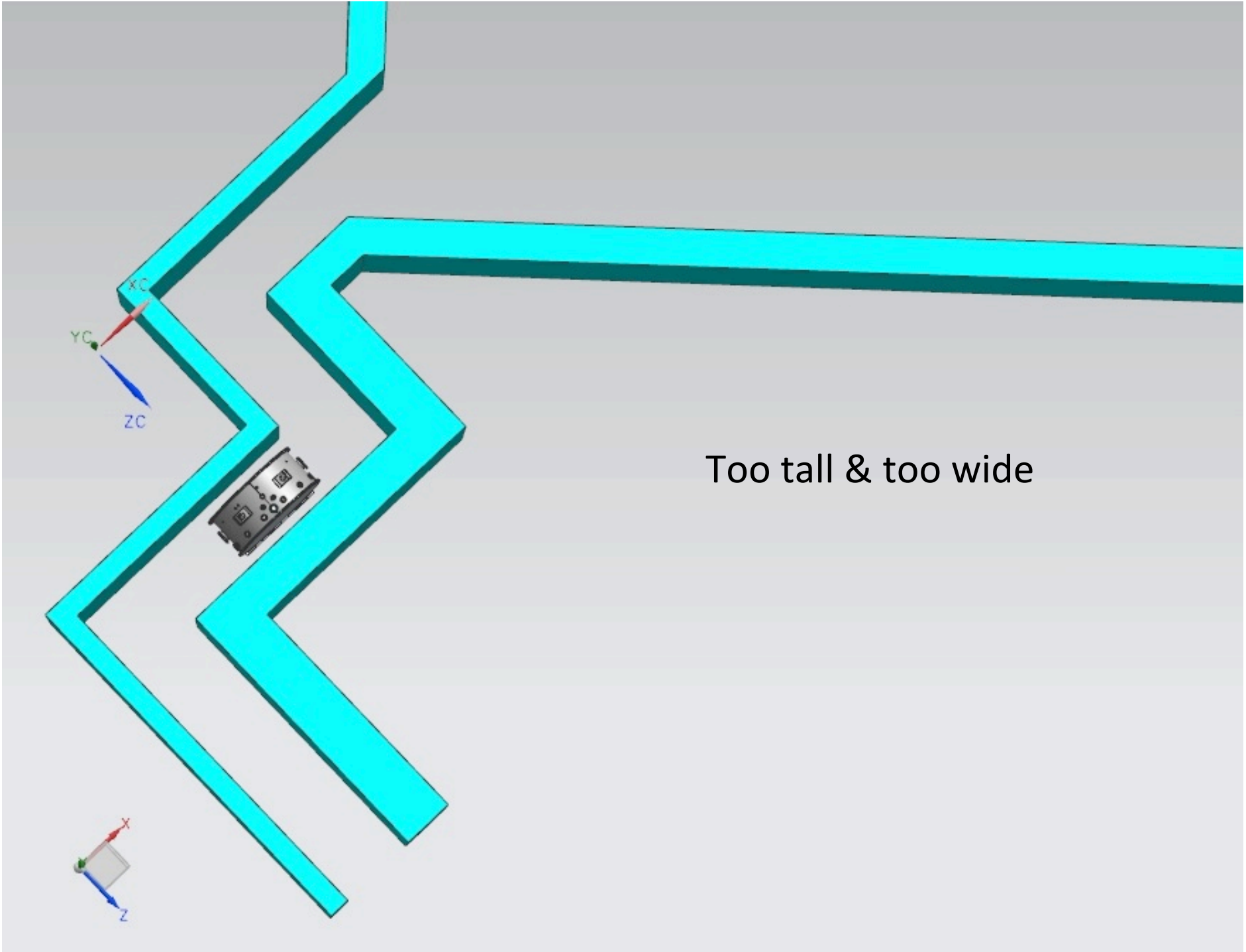

Too tall & too wide

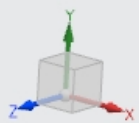
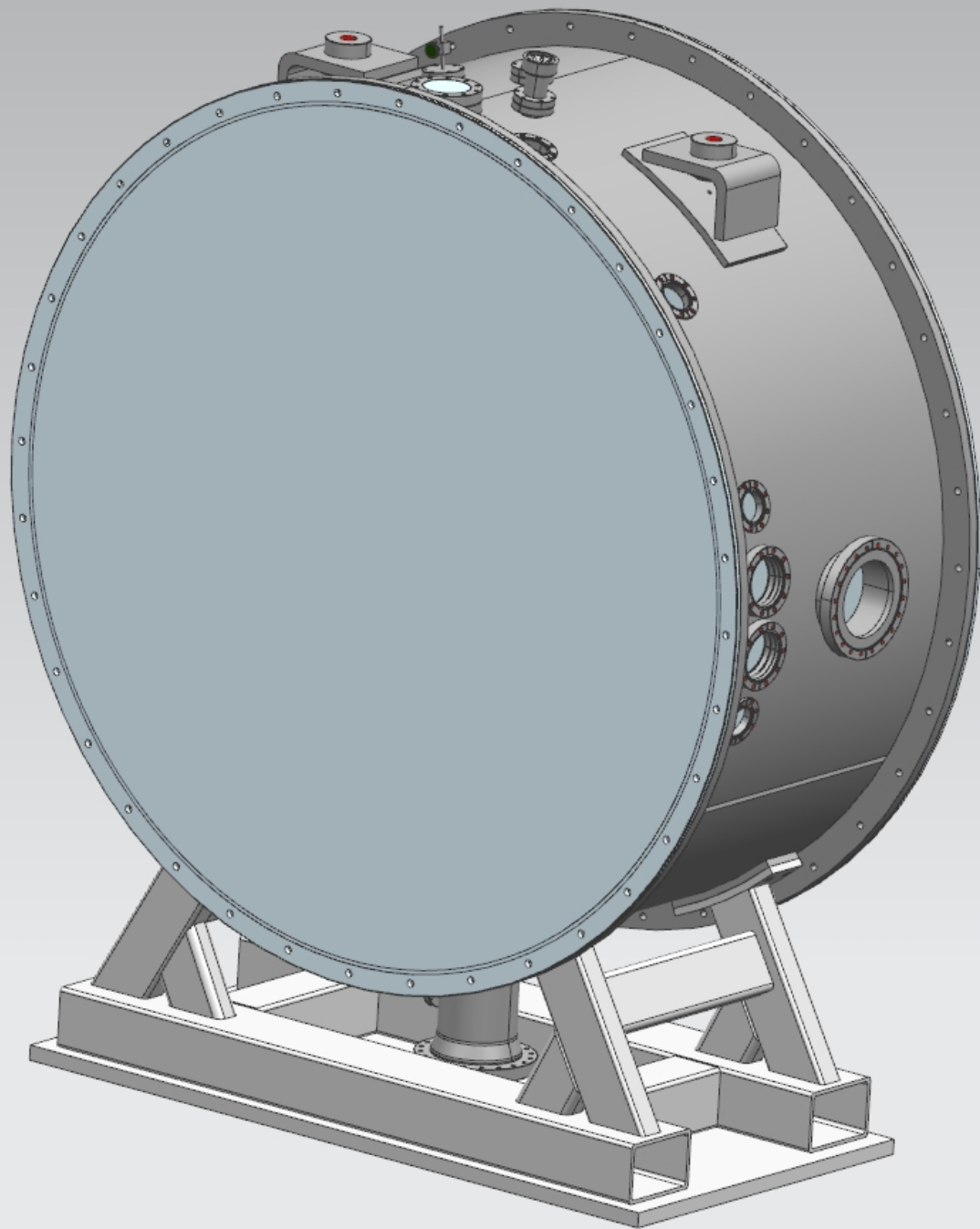



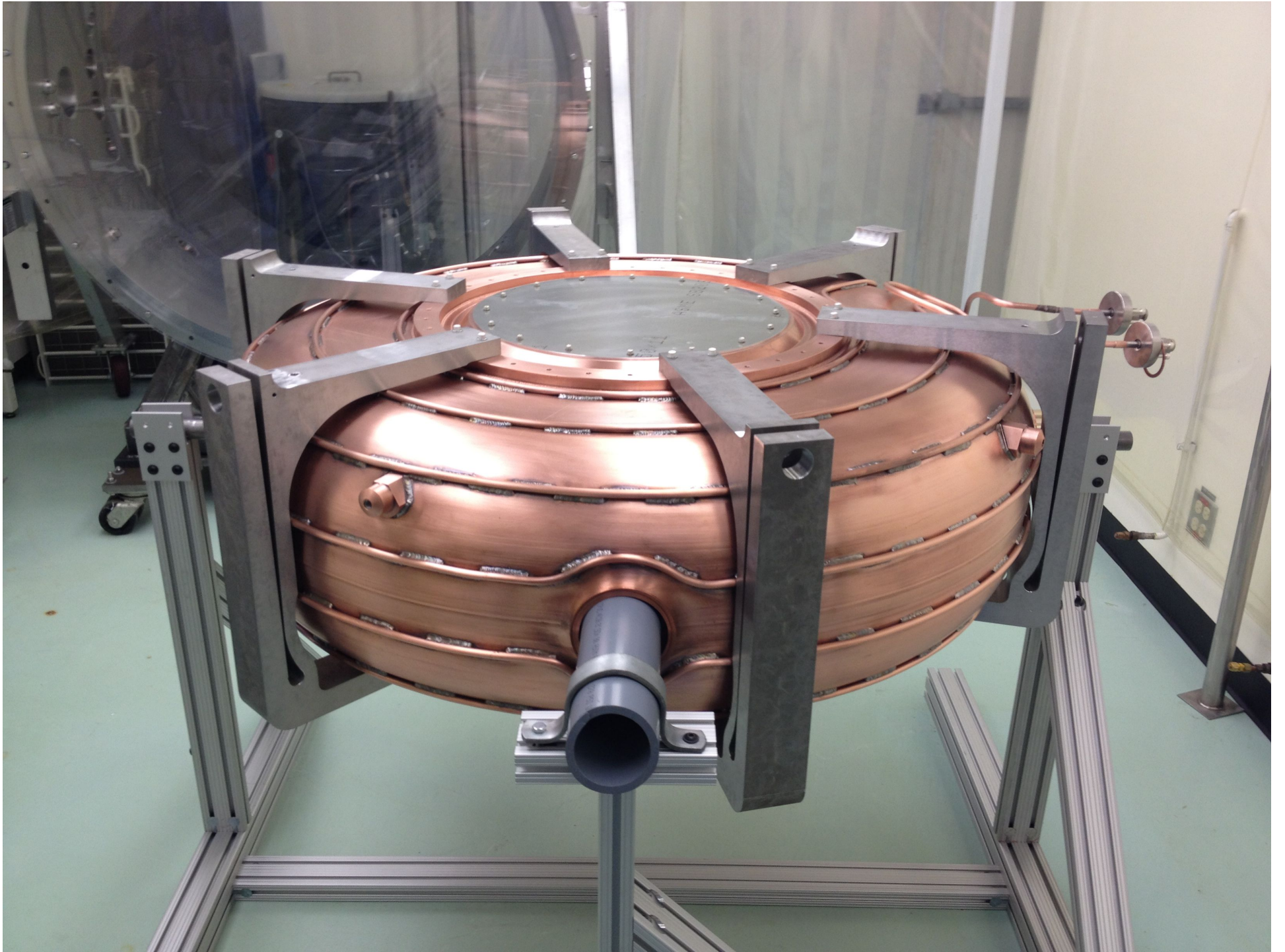

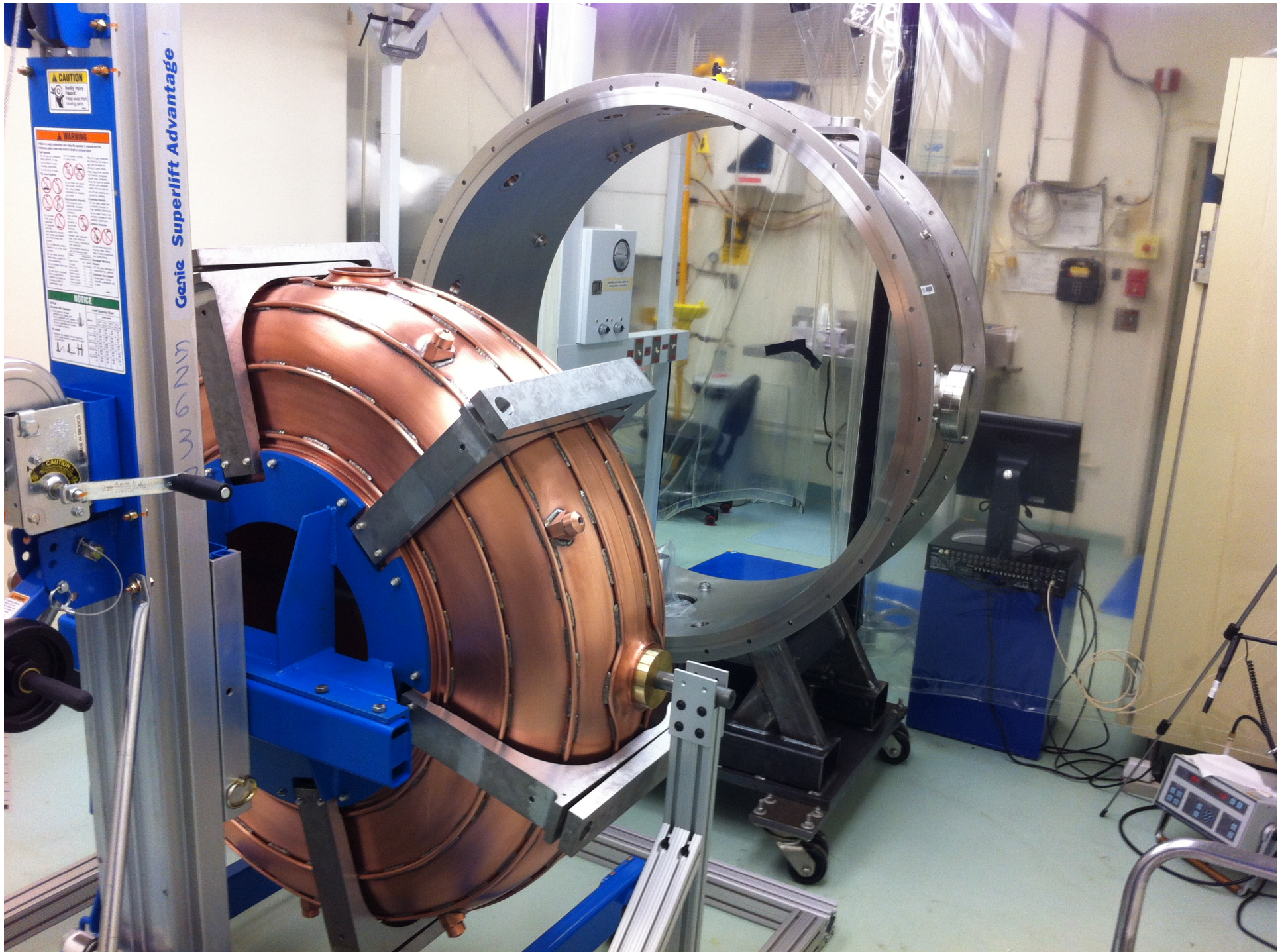



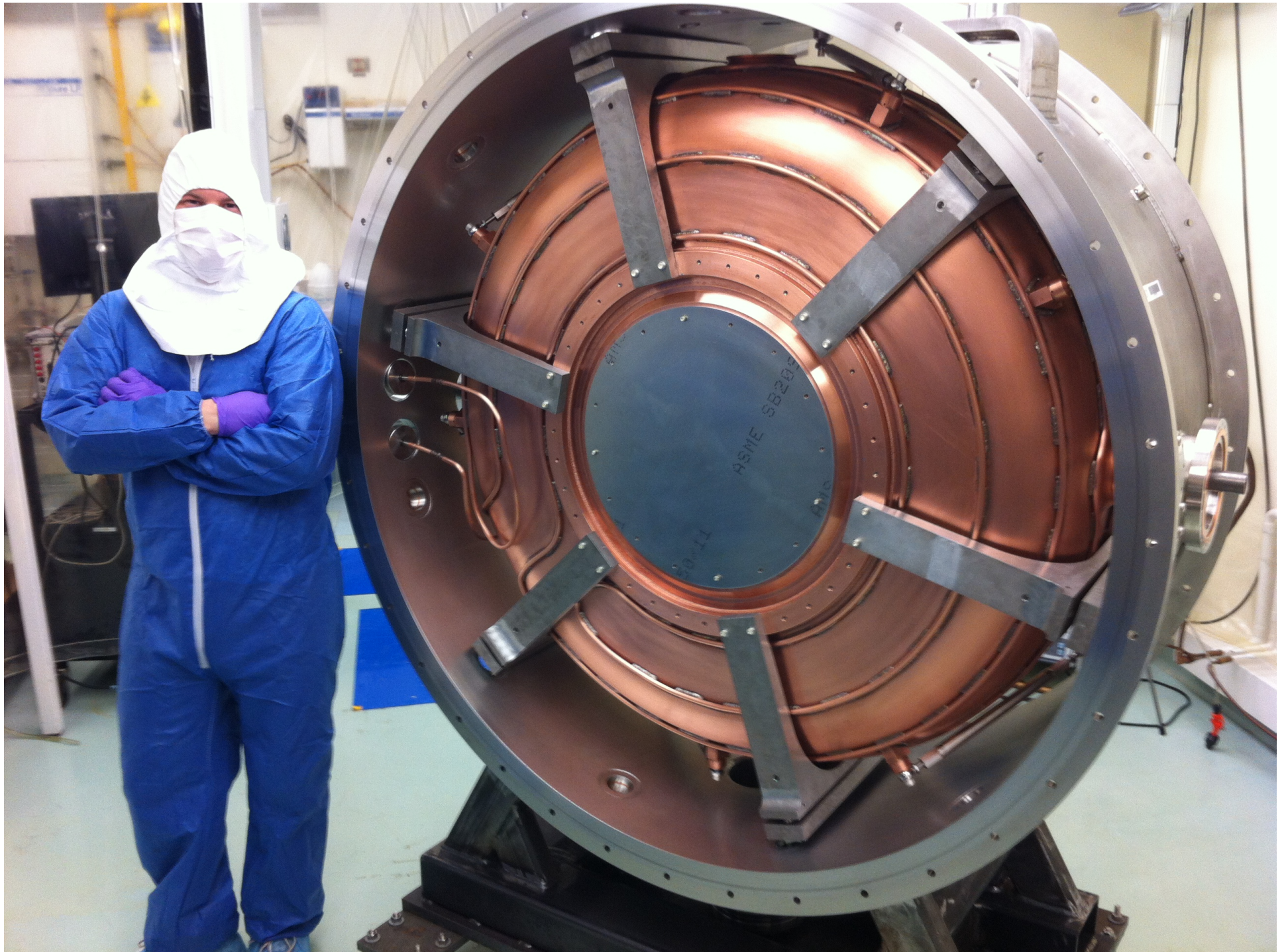



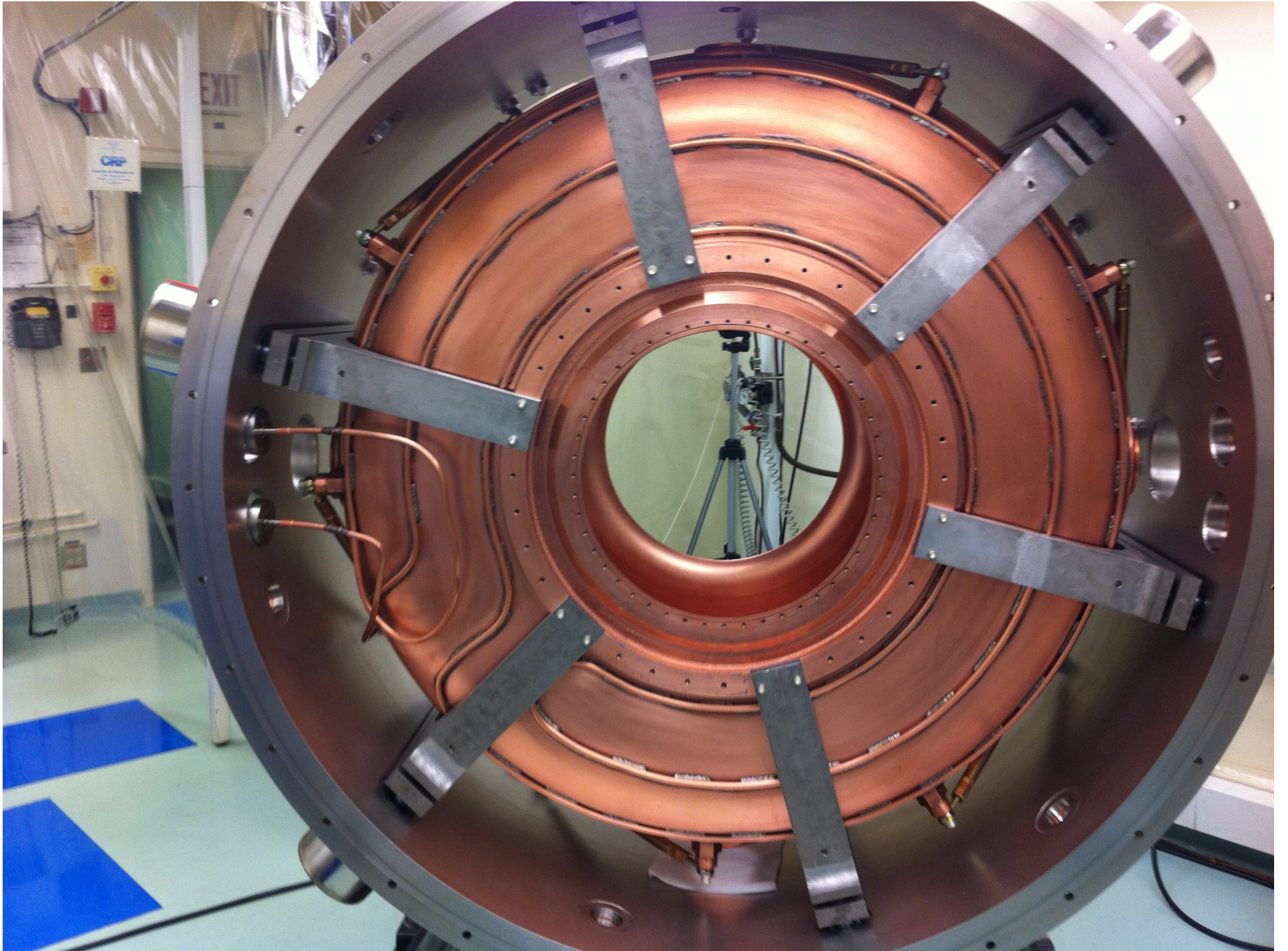

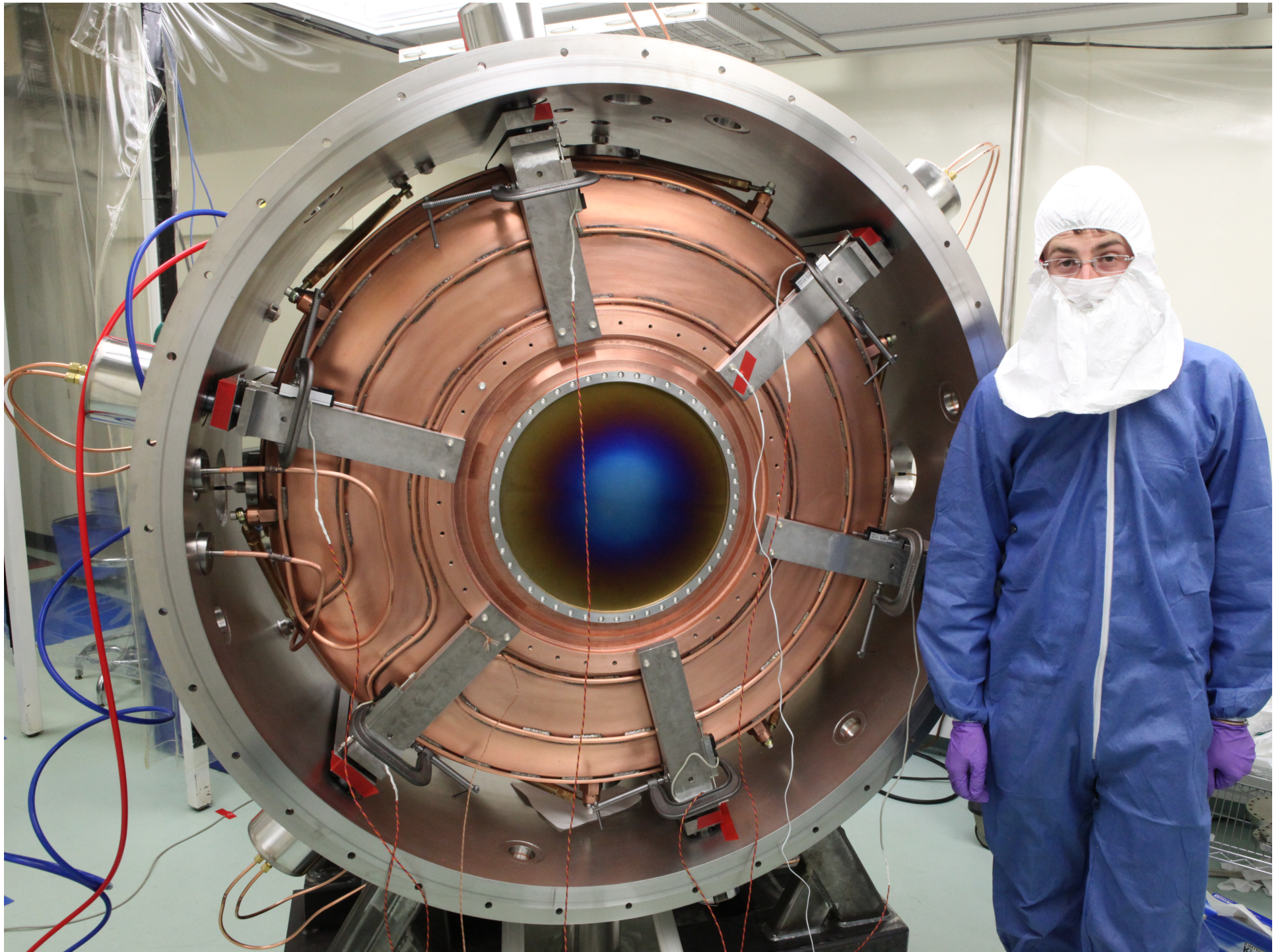



Earth Physics Division
Seismology & Strain Development
Technical Centre

19

Earth Physics Division
Seismology & Strain Development
Technical Centre

13

FRAGILE

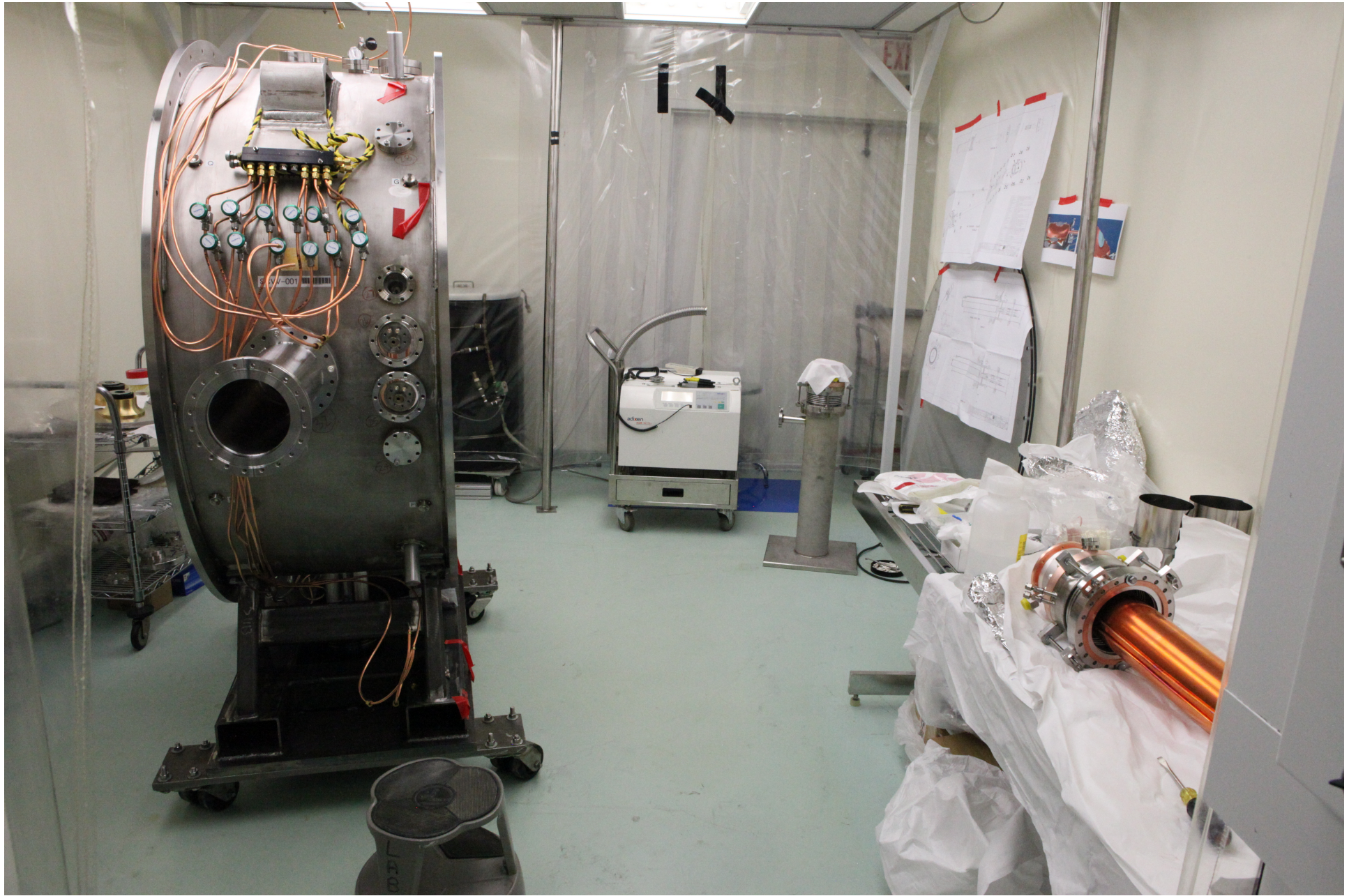







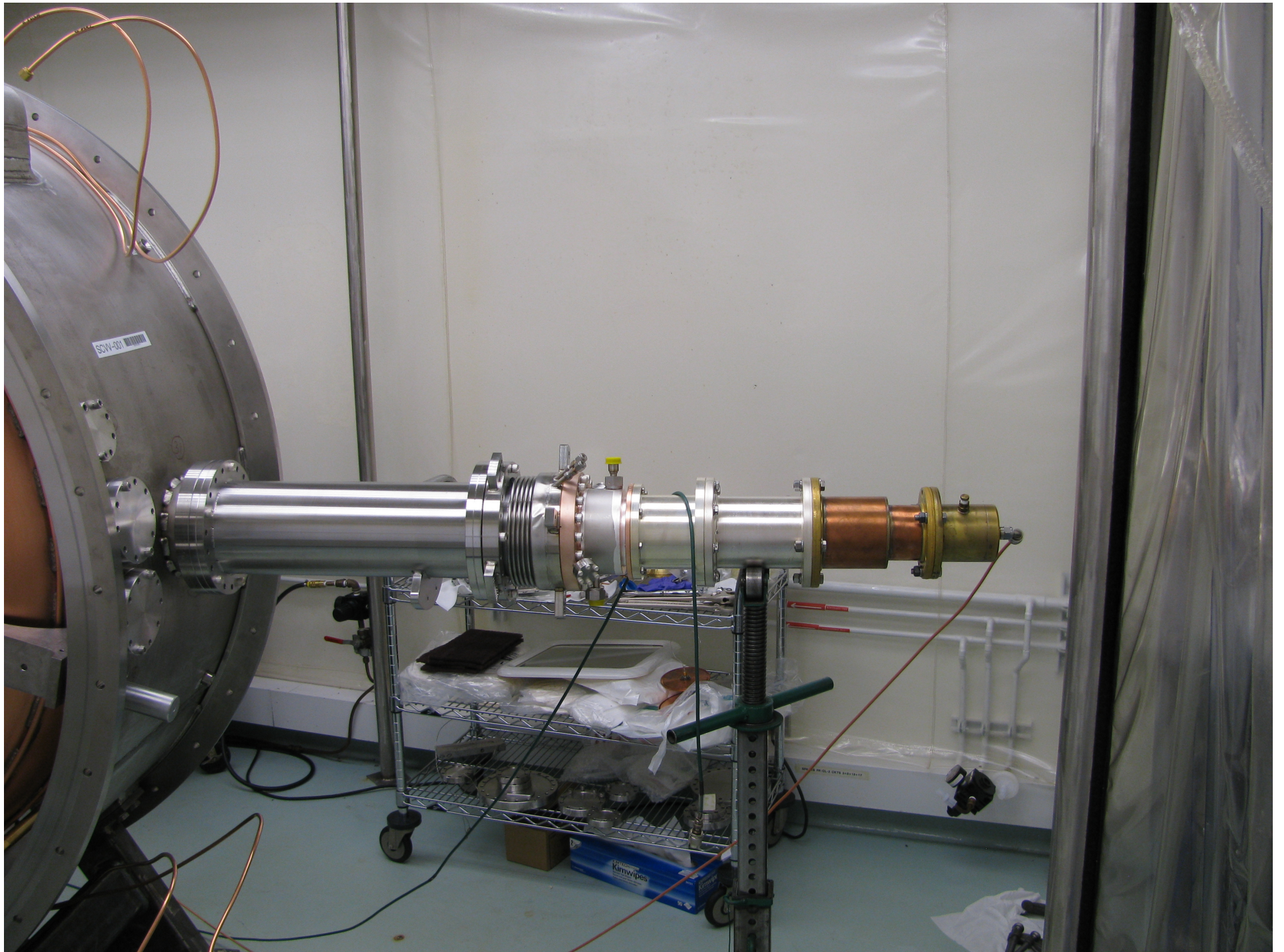

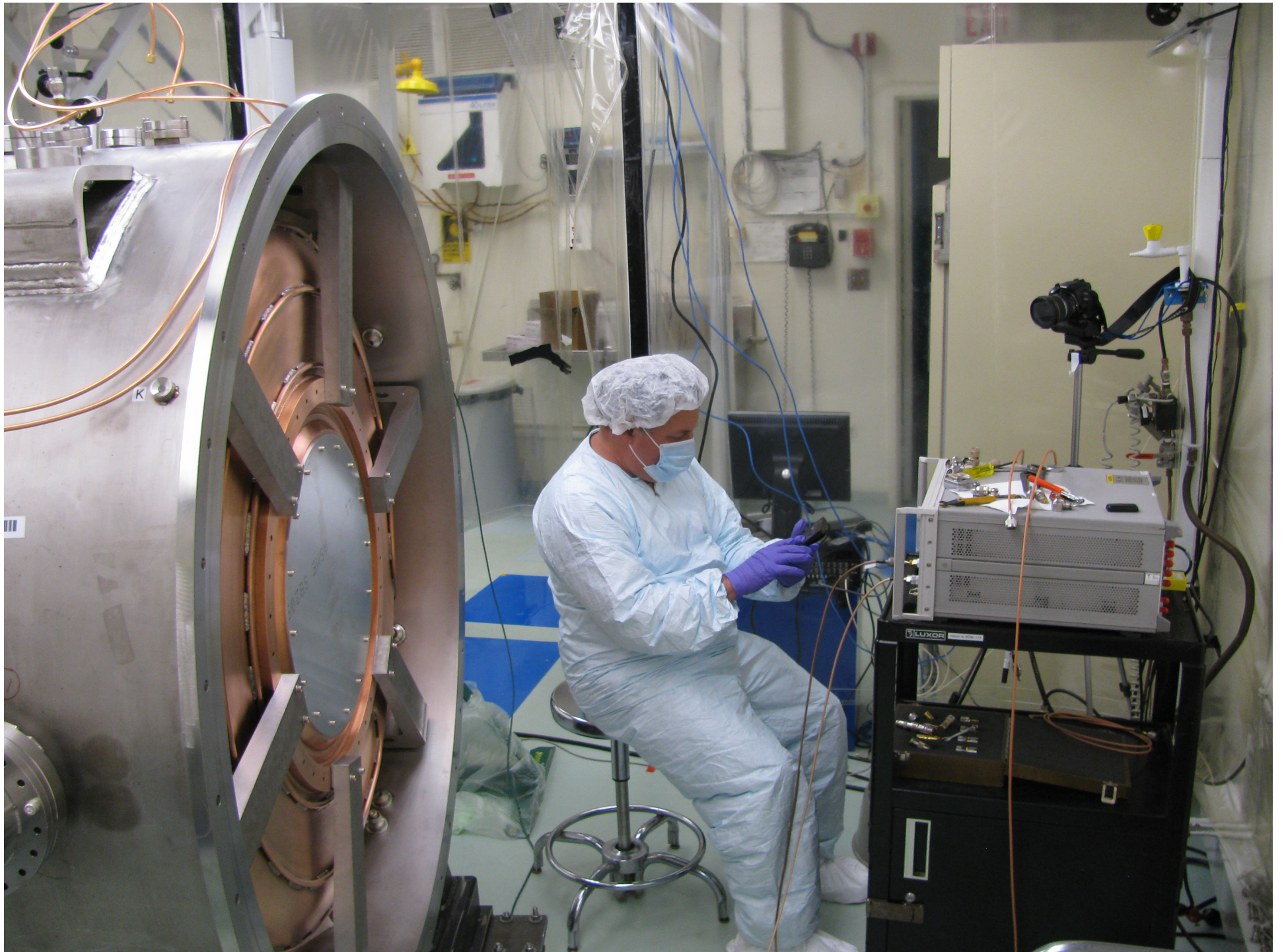

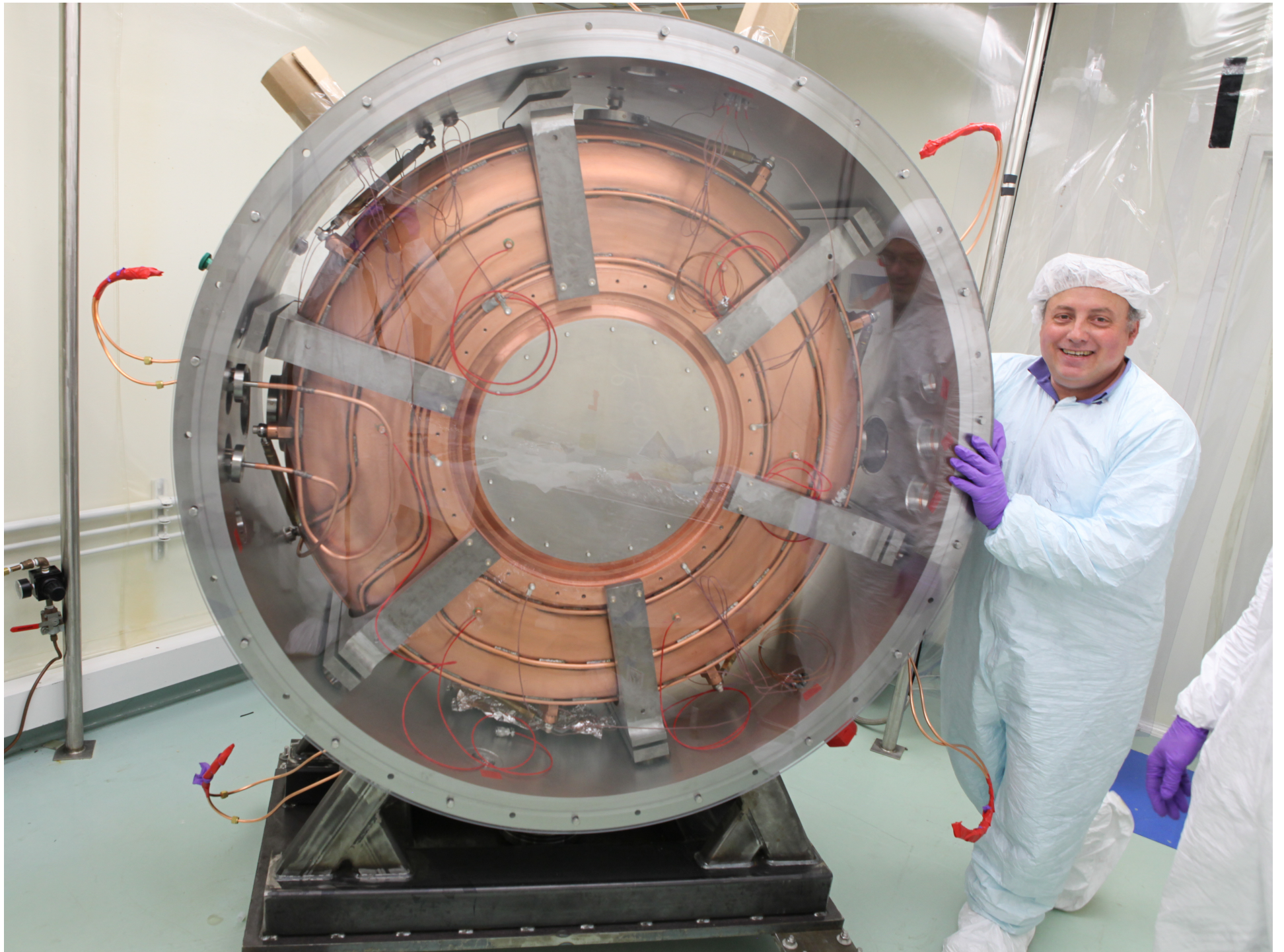







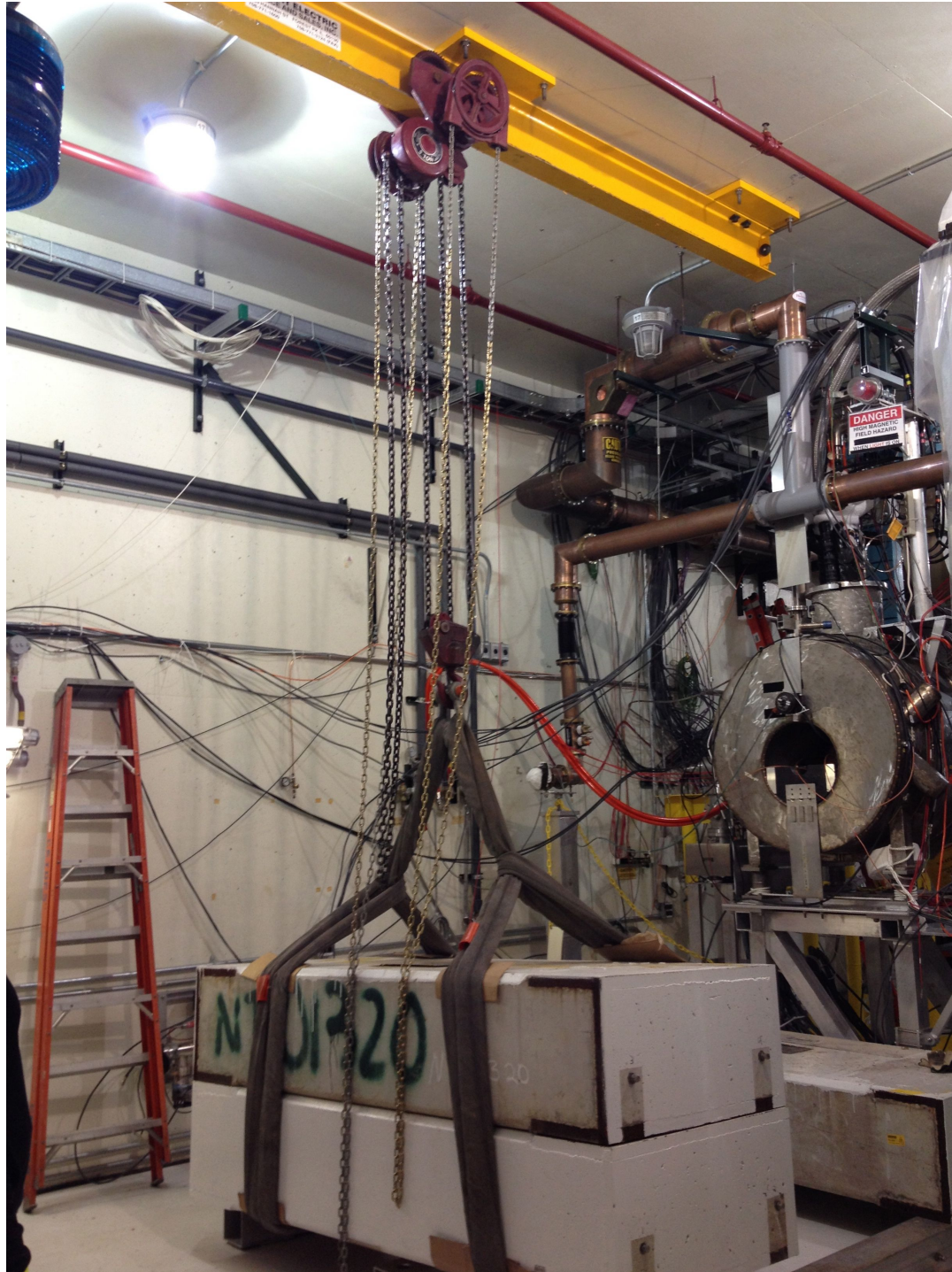







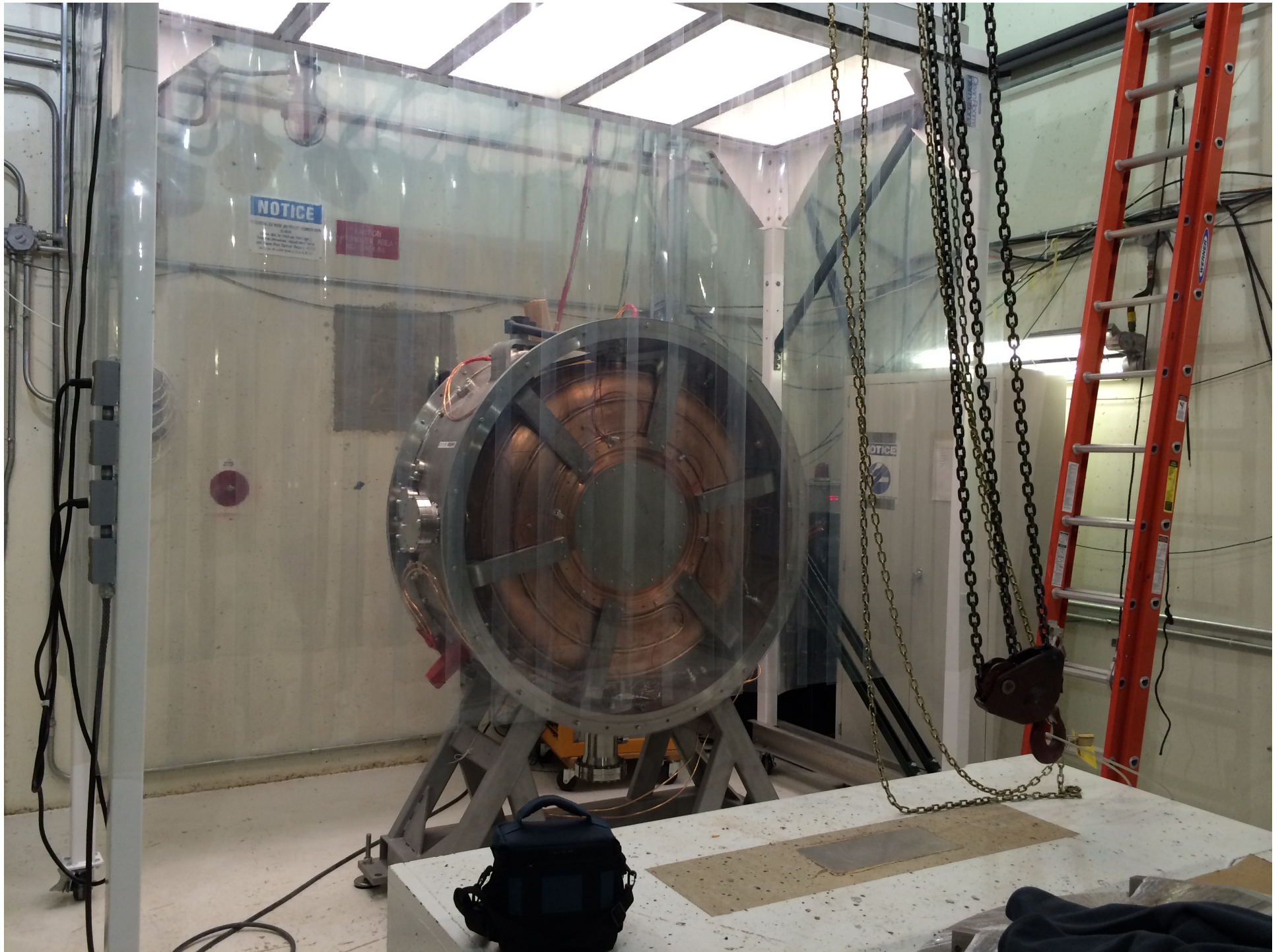

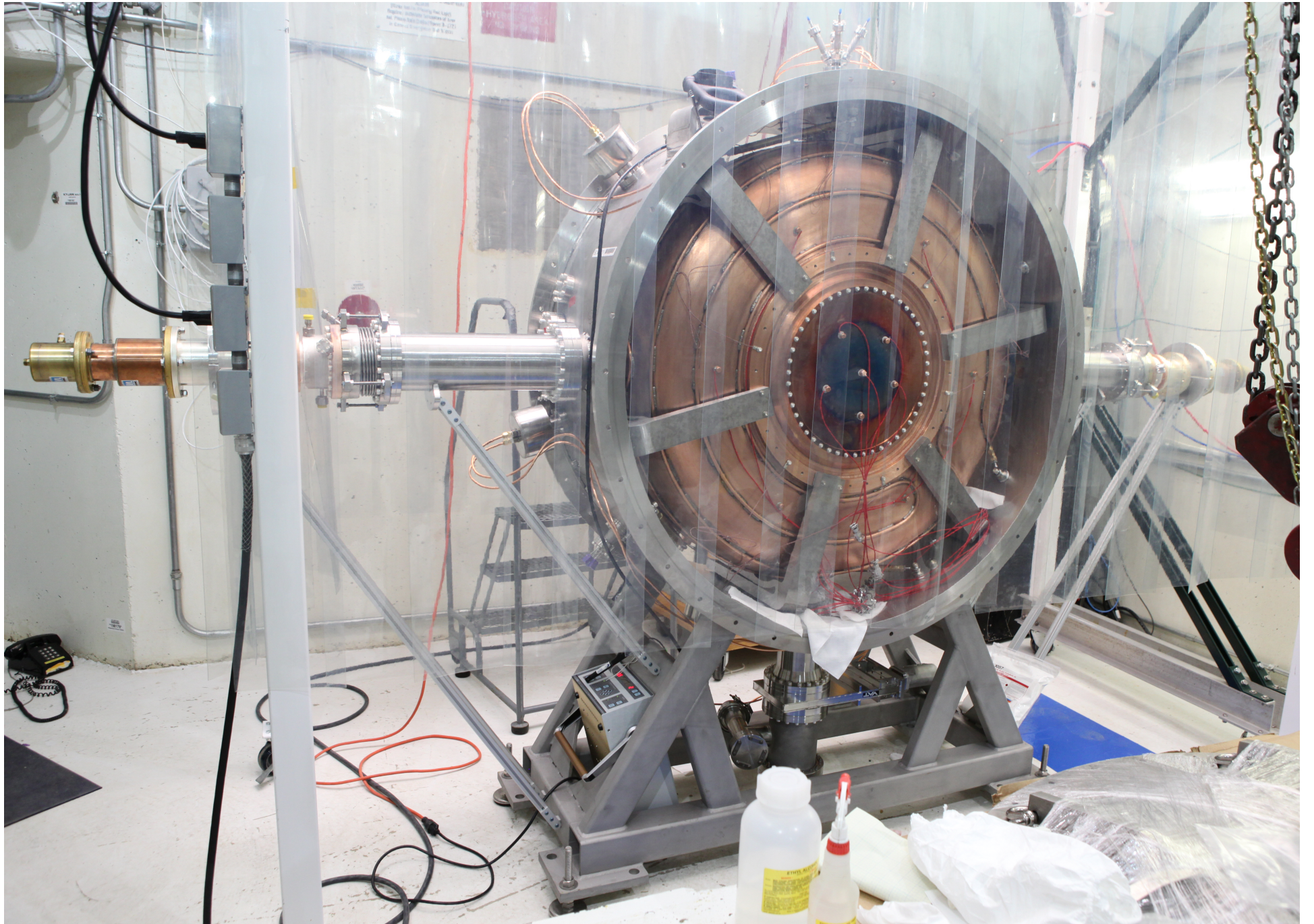



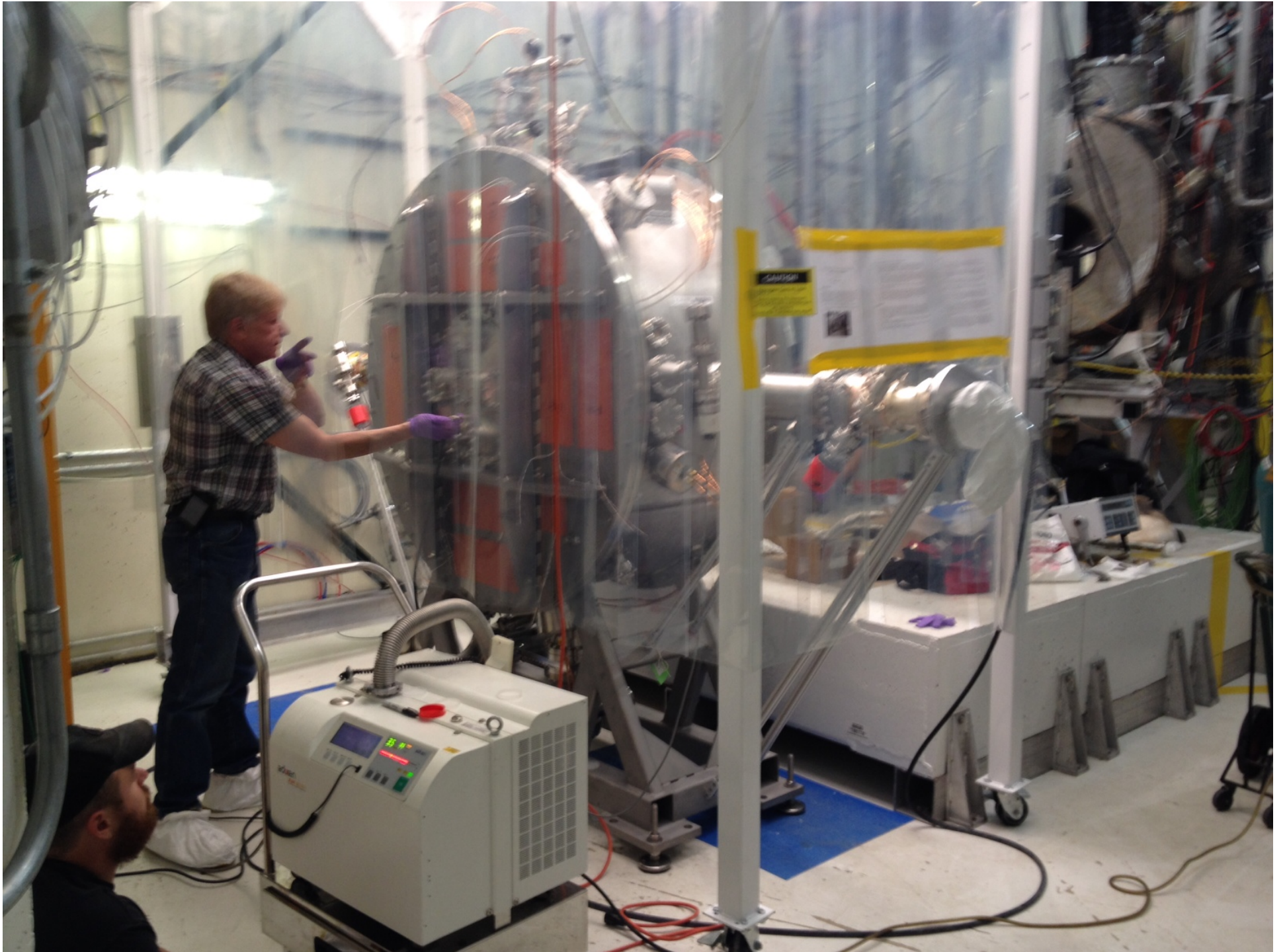

June, 2014

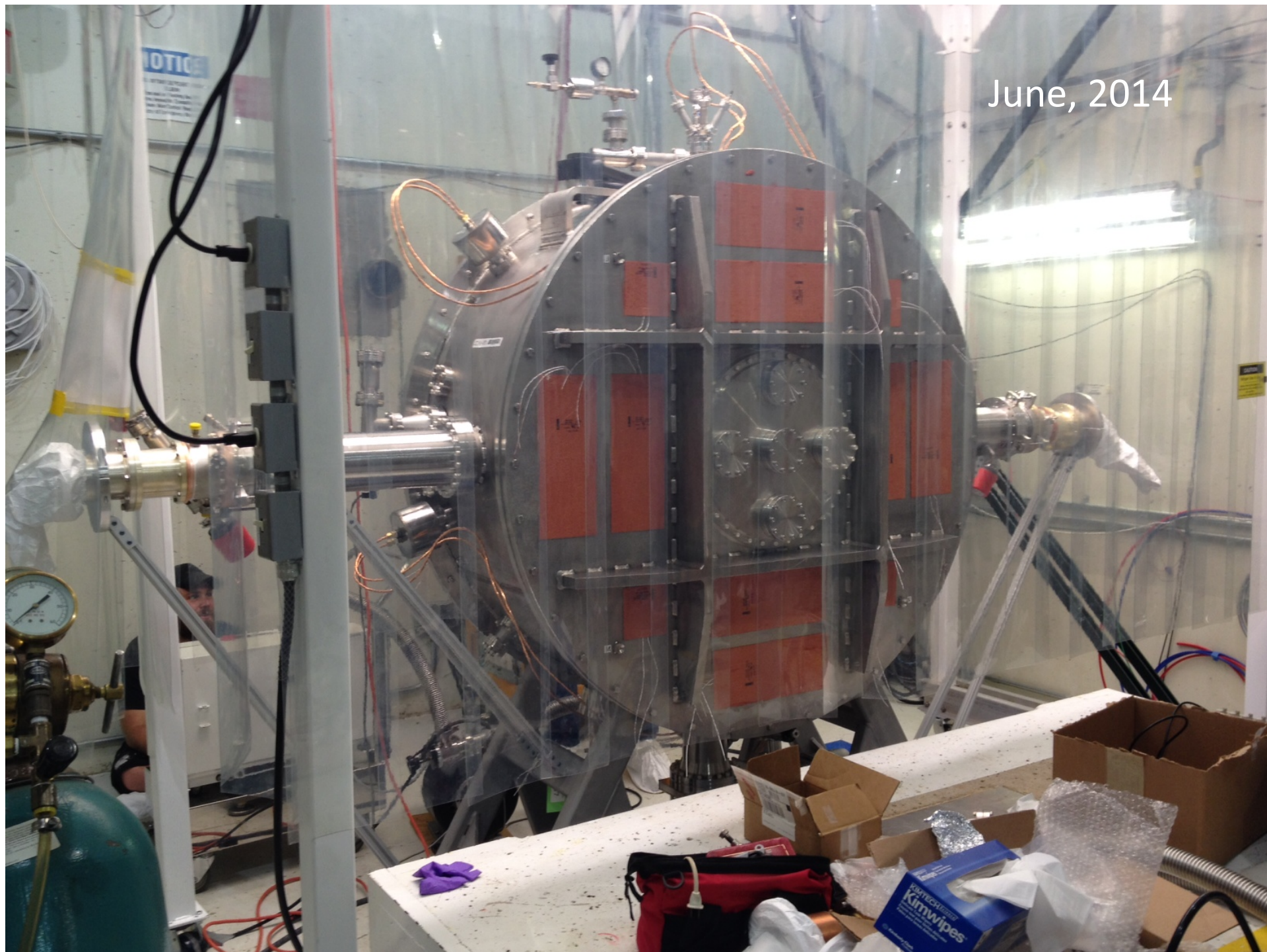

Single Cavity Assembly

Ryan Schultz