

# Ranges in respirable and inhalable dustiness and dustiness kinetics of NM powders as determined by the prototype small rotating drum - priority parameters for exposure assessment

**K. A. Jensen, M Levin, SH Nielsen,**

**AØ Jensen, B Liguori, AJ Koivisto, IK Koponen**

National Research Centre for the Working Environment, Copenhagen,

DENMARK



DET NATIONALE  
FORSKNINGSCENTER FOR ARBEJDSMILJØ



# Definition of dustiness

## ▪ Definition

- The propensity of powders to release dust as airborne particles during a standardized agitation procedures.

## ▪ Measurands

- Dustiness Index in mg/kg powder in toxicologically relevant size-fractions ( $DI_{inh}$ ,  $DI_{tho}$ ,  $DI_{resp}$ )

## ▪ Methods

- Several methods exist, but only two methods are currently accepted in standards: EN15051 (rotating drum and continuous drop method)

# The two EN15051 methods

- The rotating drum (35 cm<sup>3</sup> powder; agitation for 1 min. in 50%RH air).
- The continues drop ( $\geq 500$  cm<sup>3</sup> powder; drop until powder used, in 50%RH air)

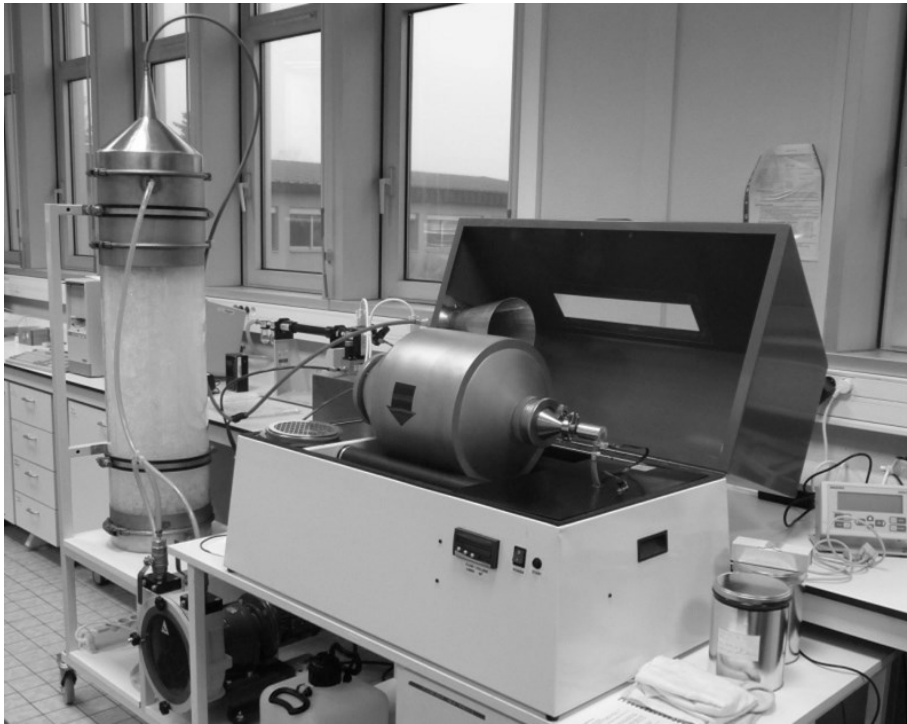

1 m



1.2 m

# Small rotating drum developed for safer testing of small amounts of “nanopowders”

- 1/5'th the volume of the EN15051 drum; ; agitation for 1 min. in 50%RH air)
- Use <6 g powder (consideration of standard volume instead)
- Simoultaneous online measurement with different aerosol monitors and PM.

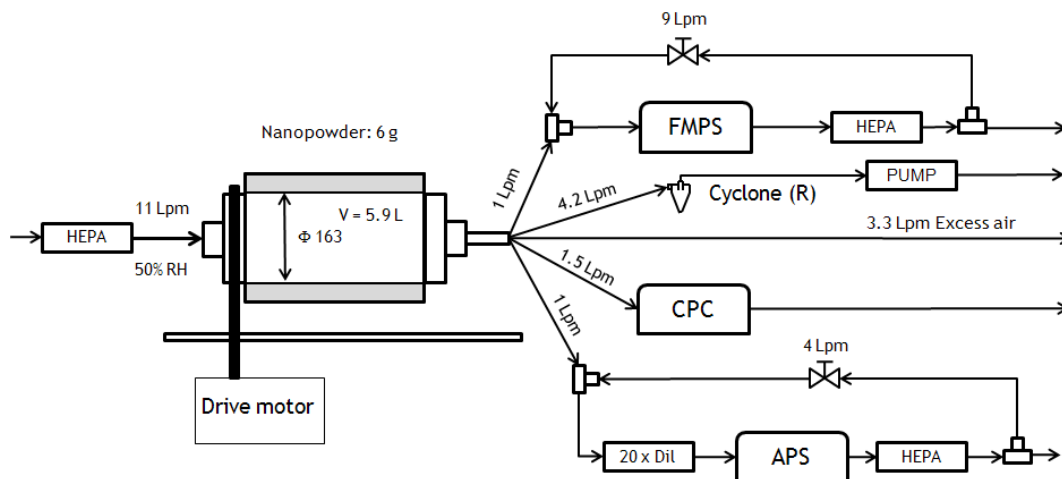

DET NATIONALE  
FORSKNINGSCENTER FOR ARBEJDSMILJØ

(Schneider and Jensen, 2008); Jensen et al., 2009; Levin et al., 2014...)

# Measurands

## ▪ Original Purpose in EN15051

- Relatively rank powder dustiness in mg/kg powder for assessment of release potential (importance for processing, design and risk management)

## ▪ New additional aims

- More specific test methods
- Data for more quantitative exposure assessment and prioritization in material selection (nano-focus)



DET NATIONALE  
FORSKNINGSCENTER FOR ARBEJDSMILJØ



 Institut National de Recherche et de Sécurité  
Karlsruhe (Germany), June 18<sup>th</sup> 2014

**DUSTiness of NANOpowders (DUSTINANO):**  
A CEN pre-normative research project to harmonize dustiness methods for manufactured nanomaterial powders

Coordinated by Olivier Witschger, INRS

 PARTNERSHIP FOR EUROPEAN RESEARCH IN OCCUPATIONAL SAFETY AND HEALTH  
  
  
  
  
  

Institut national de recherche et de sécurité  
pour la prévention des accidents du travail et des maladies professionnelles

# Dustiness data already used for technical evaluation and exposure assessment

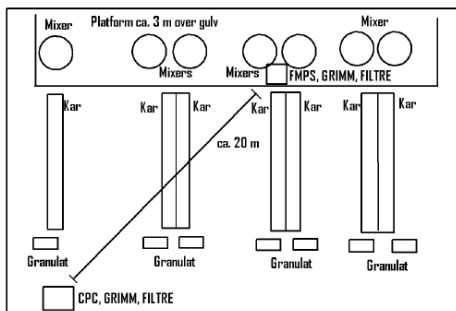

## Emission Potential Simulated work processes

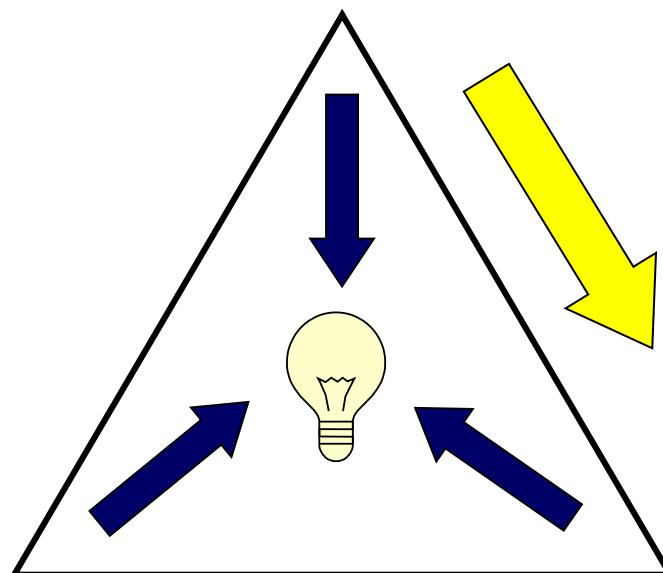

Akut eksponering i nærmeområdet (15 minutter)

Standard Eksponering	0,78 - 1,00	0,51 - 0,75	0,26 - 0,50	0,00 - 0,25
> 1,00				
0,51 - 1,00				
0,26 - 0,50				
0,11 - 0,25				★
< 0,10				

Akut eksponering i arbejdslokalet (15 minutter)

Standard Eksponering	0,78 - 1,00	0,51 - 0,75	0,26 - 0,50	0,00 - 0,25
> 1,00				
0,51 - 1,00				
0,26 - 0,50				
0,11 - 0,25				
< 0,10				★

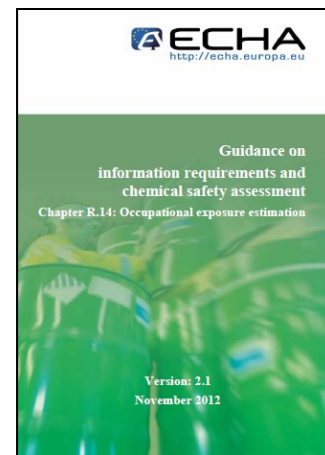

**Workplace Measurement**

DET NATIONALE  
 FORSKNINGSCENTER FOR ARBEJDSMILJØ

**Exposure (Risk) Modelling**

# Exposure scaling/estimation in several Control Banding tools

Probability factor	Maximum points	Maximum probability score
Estimated amount of nanomaterial	25	100
Dustiness/mistiness	30	
Number of employees with similar exposure	15	
Frequency of operation	15	
Duration of operation	15	

Severity

	Probability			
	Extremely Unlikely (0-25)	Less Likely (26-50)	Likely (51-75)	Probable (76-100)
Very High (76-100)	RL 3	RL 3	RL 4	RL 4
High (51-75)	RL 2	RL 2	RL 3	RL 4
Medium (26-50)	RL 1	RL 1	RL 2	RL 3
Low (0-25)	RL 1	RL 1	RL 1	RL 2

**Example: US CB NANOTOOL (Paik et al., 2008)**

Control bands:

RL 1: General Ventilation

RL 2: Fume hoods or local exhaust ventilation

RL 3: Containment

RL 4: Seek specialist advice



DET NATIONALE  
FORSKNINGSCENTER FOR ARBEJDSMILJØ

# Intrinsic part of dustiness classes in some REACH R.14 recommended tools

ECETOC-TRA

**Table R.14-5:** Help on fugacity selection criteria

General description	Relative dustiness potential	Typical materials	TRA Selection Value
Not dusty	1	Plastic granules <sup>a</sup> , pelleted fertilisers	<b>Low</b>
Slightly dusty	10 - 100 times dustier	Dry garden peat, sugar, salt	<b>Low /Medium <sup>c</sup></b>
Dusty	100 - 1,000 times dustier	Talc, graphite	<b>Medium</b>

EMKG-EXPO

**Table R.14-10: Definition of dustiness bands**

<b>High</b>	Fine, light powders. When used, dust clouds can be seen to form and remain airborne for several minutes. For example: cement, titanium dioxide, photocopier toner
<b>Medium</b>	Crystalline, granular solids. When used, dust is seen, but it settles quickly. Dust is seen on the surface after use. For example: soap powder, sugar granules
<b>Low</b>	Pellet-like, non friable solids. Little evidence of any dust observed during use. For example: PVC pellets, waxes



# First order estimation of NF and FF NOAA dust exposure potential (e.g., NanoSafer algorithm)

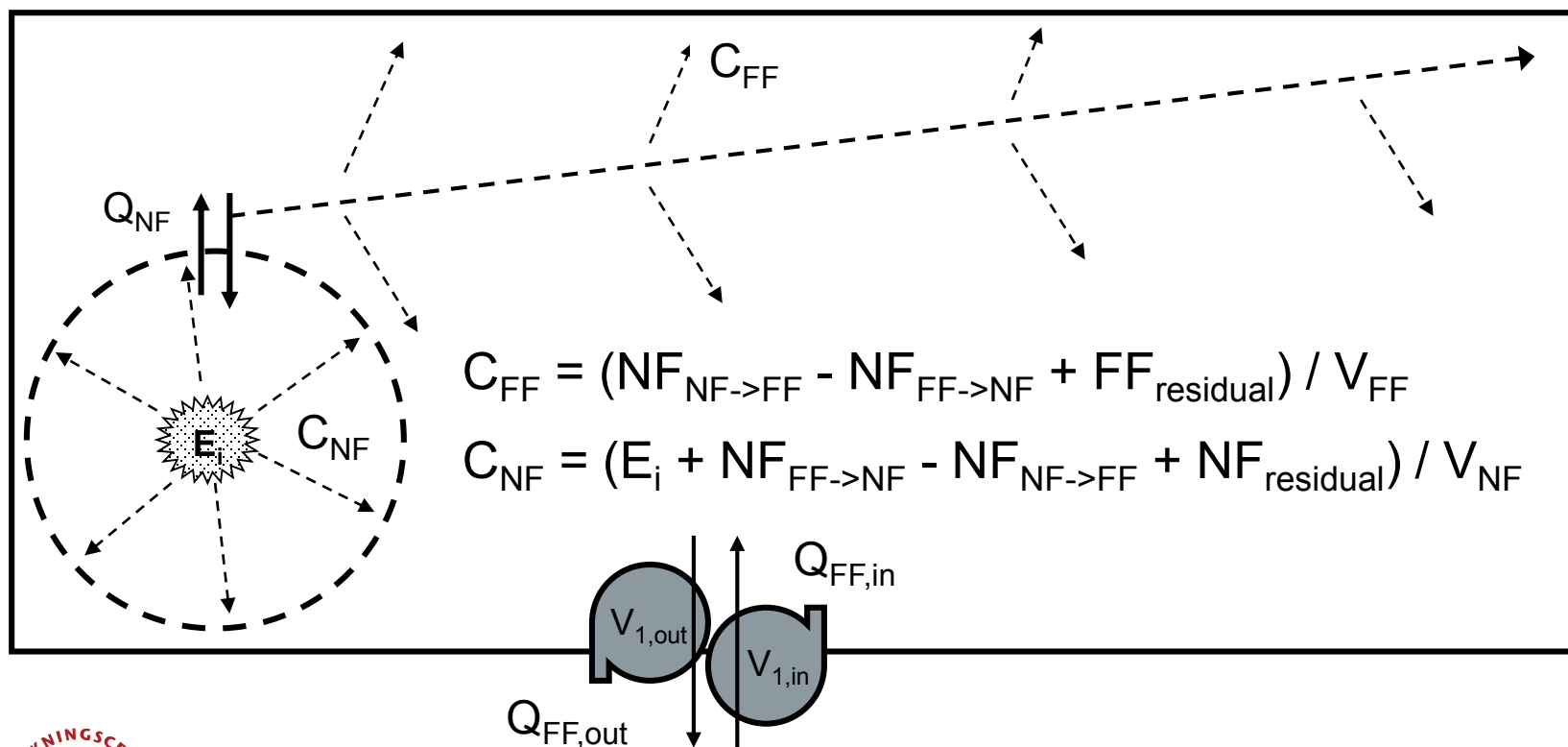

DET NATIONALE  
FORSKNINGSCENTER FOR ARBEJDSMILJØ

# Conceptual Exposure Assessment Model for NOAA

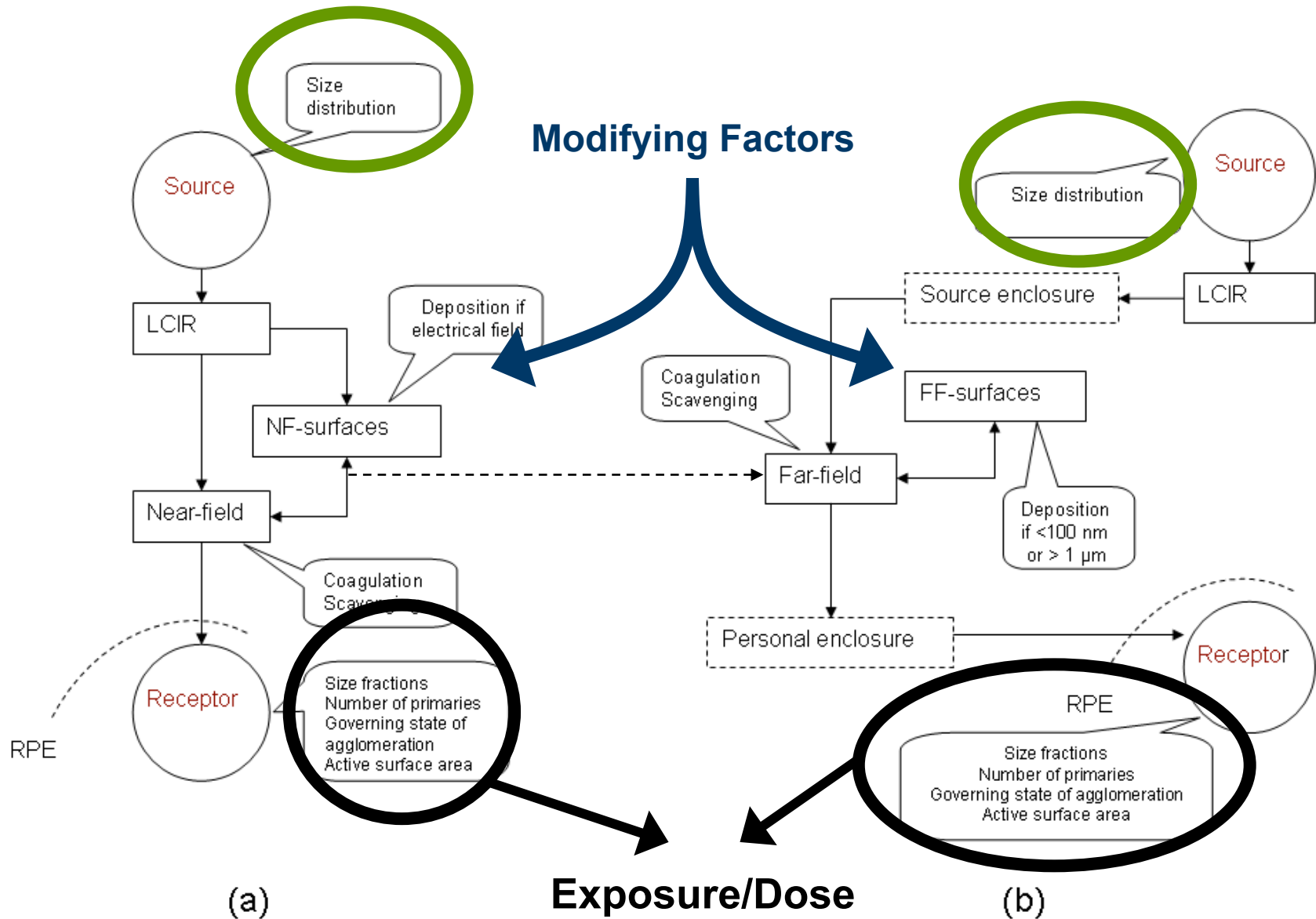

LCIR: Local Control Influence Region

Schneider et al. (2009; 2011)

# Applicability of Dustiness ranges for NOAA: EN15051 Rotating Drum systems

ECETOC-TRA

**Table R.14-5:** Help on fugacity selection criteria

General description	Relative dustiness potential	Typical materials	TRA Selection Value
Not dusty	1	Plastic granules <sup>a</sup> , pelleted fertilisers	Low
Slightly dusty	10 - 100 times	Drum treatment sugar,	Low /Medium <sup>c</sup>
Dusty	100 - 1,000 times dustier	Talc, graphite	Medium

Max/Min Index ratio  $\geq 100$

EN15051

Dustiness class	DI(resp)	DI(inh)
High	>250 mg/Kg	5000 mg/Kg
Moderate	250 mg/Kg	1000 – 5000 mg/Kg
Low	50 mg/Kg	200 – 1000 mg/Kg
Very Low	10 mg/Kg	< 200 mg/Kg

Max/Min Index ratio  $\geq 25$

# Variation Inhalable dustiness indices of fine pigments and “nanopowders”?

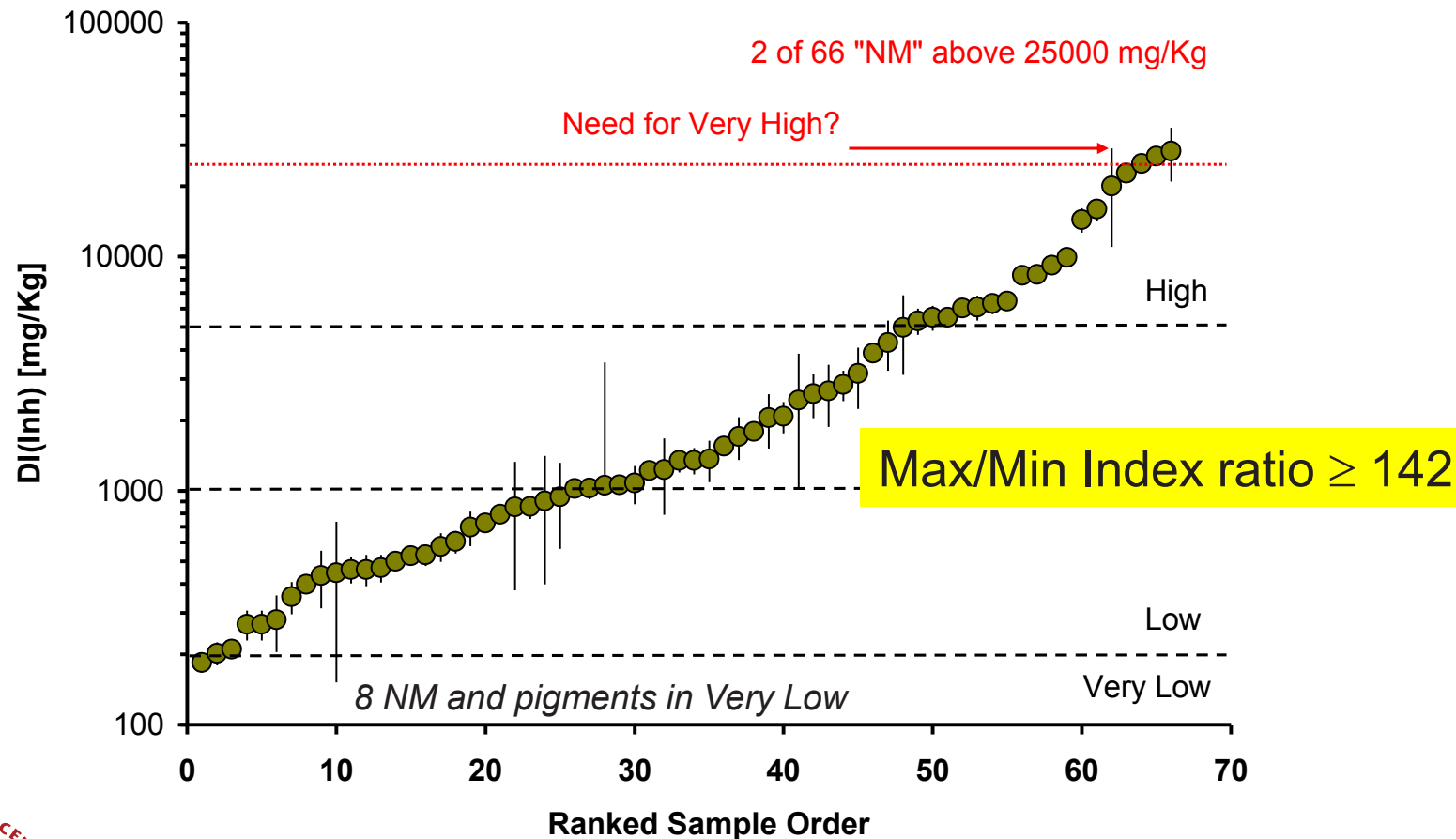

# Variation respirable dustiness indices of fine pigments and “nanopowders”?

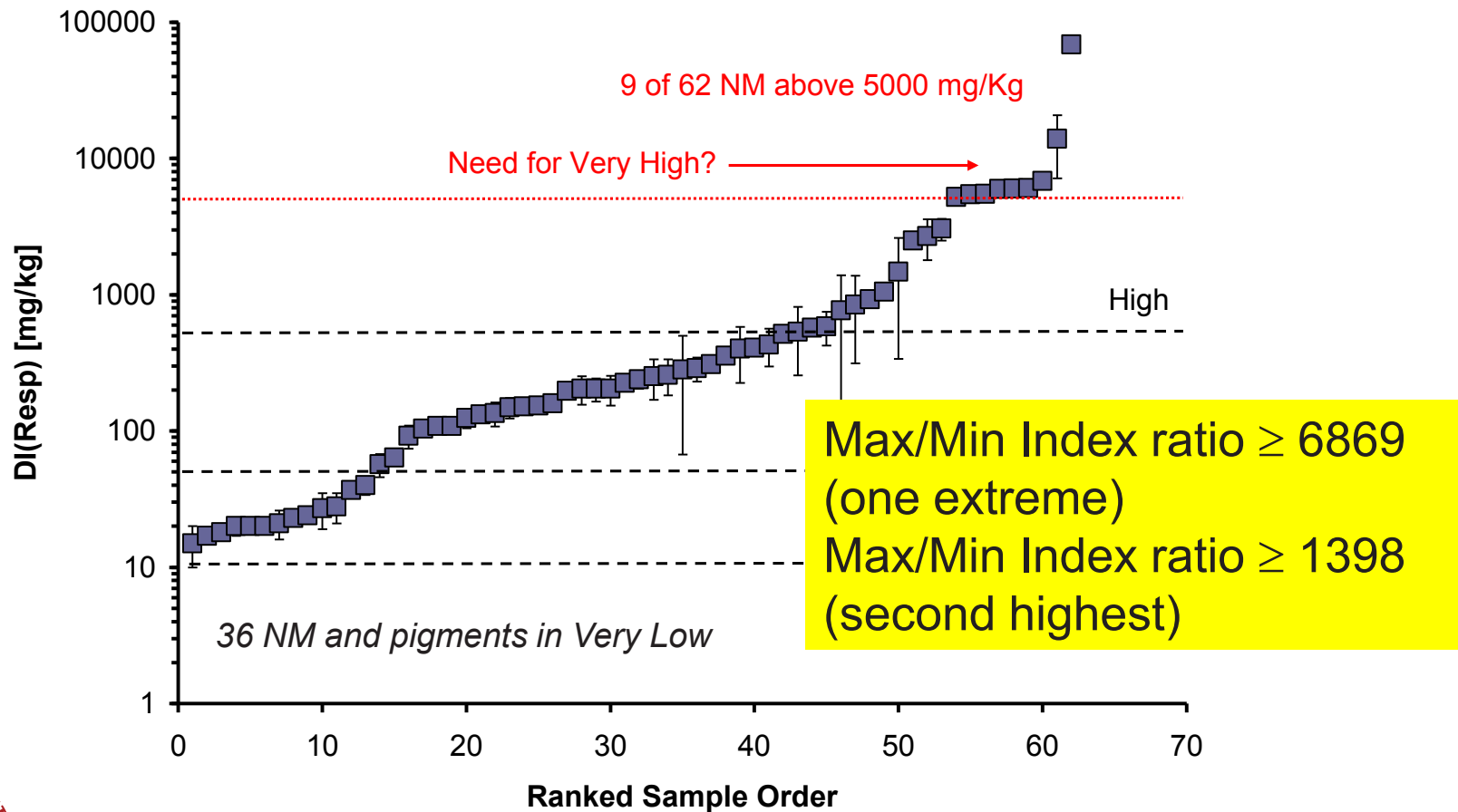

# Applicability of Dustiness ranges for NOAA: EN15051 Rotating Drum systems

ECETOC-TRA

**Table R.14-5:** Help on fugacity selection criteria

General description	Relative dustiness potential	Typical materials	TRA Selection Value
Not dusty	1	Plastic granules <sup>a</sup> , pelleted fertilisers	Low
Slightly dusty	10 - 100 times dustier	Dry garden peat, sugar,	Low /Medium <sup>c</sup>
Dusty	100 - 1,000 times dustier	Talc, graphite	Medium

EN15051

Dustiness class	DI(resp)	Max/Min Index ratio $\geq 25$	DI (inh)
High	250 - 1000		5000 - 10000
Moderate	Experimentally DI(resp) Max/Min Index ratio $\geq 6869$ (one extreme)		Experimentally DI (inh) Max/Min Index ratio $\geq 142$
Low	Max/Min Index ratio $\geq 1398$ (second highest)		200 - 1000 mg/Kg
Very Low			< 200 mg/Kg

# Variation in dustiness classes within material groups?

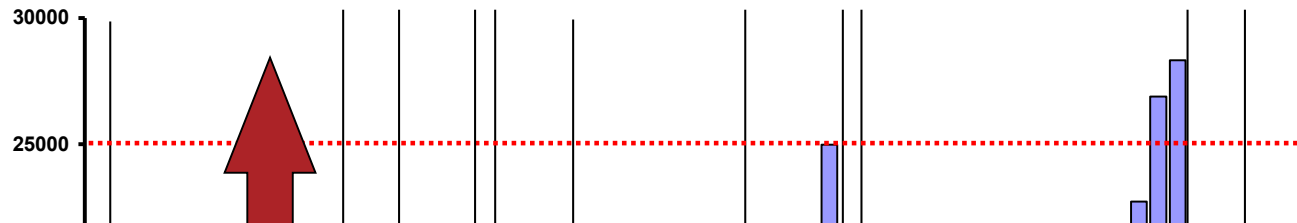

Huge (unacceptable) range for exposure assessments (or very high high uncertainty)  
Possibly sufficient for technical property classification and direct exposure management

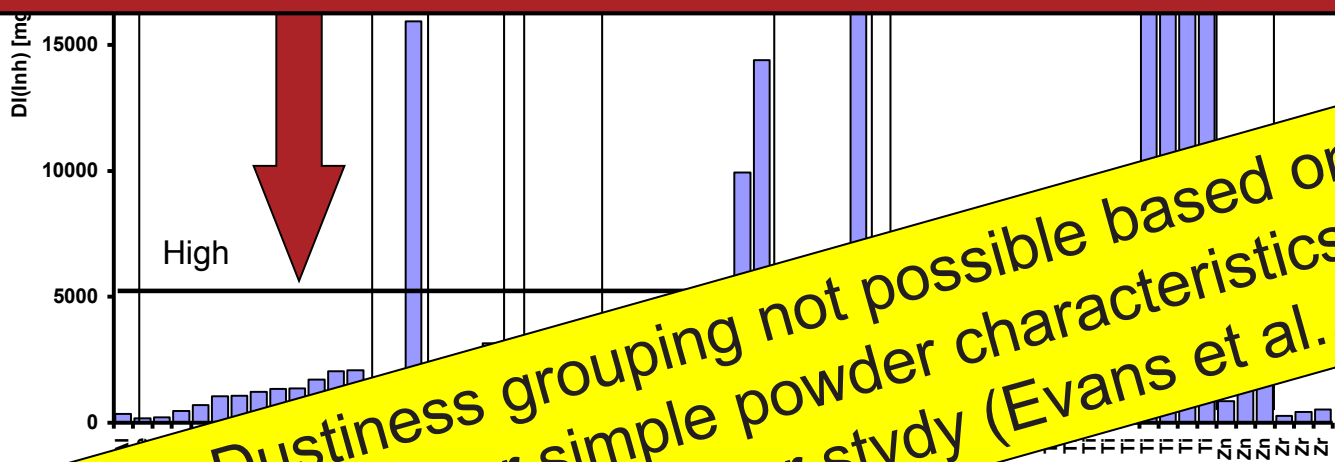

Dustiness grouping not possible based on material type or simple powder characteristics alone!  
(also clear from another study (Evans et al., 2014))



# Benefits of the online monitoring data in the nanospecific dustiness testing?

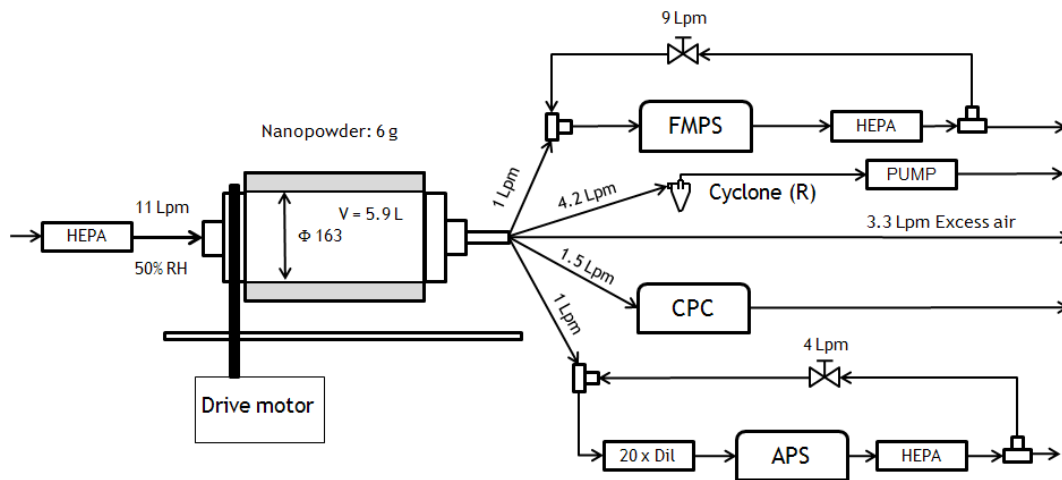

*Dust particle size-distributions*  
*Dustiness kinetics (Particle Generation Rate)*



# Added value of Size-distribution Measurements?

## - Nano-Objects Aggregates and Agglomerates -

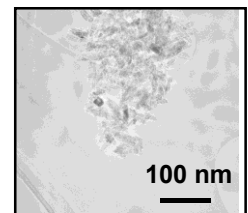
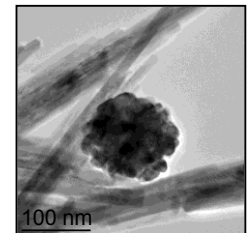
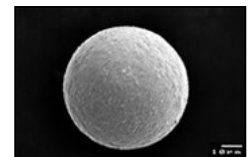
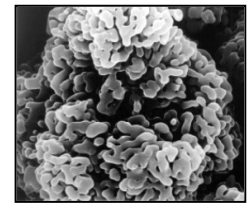
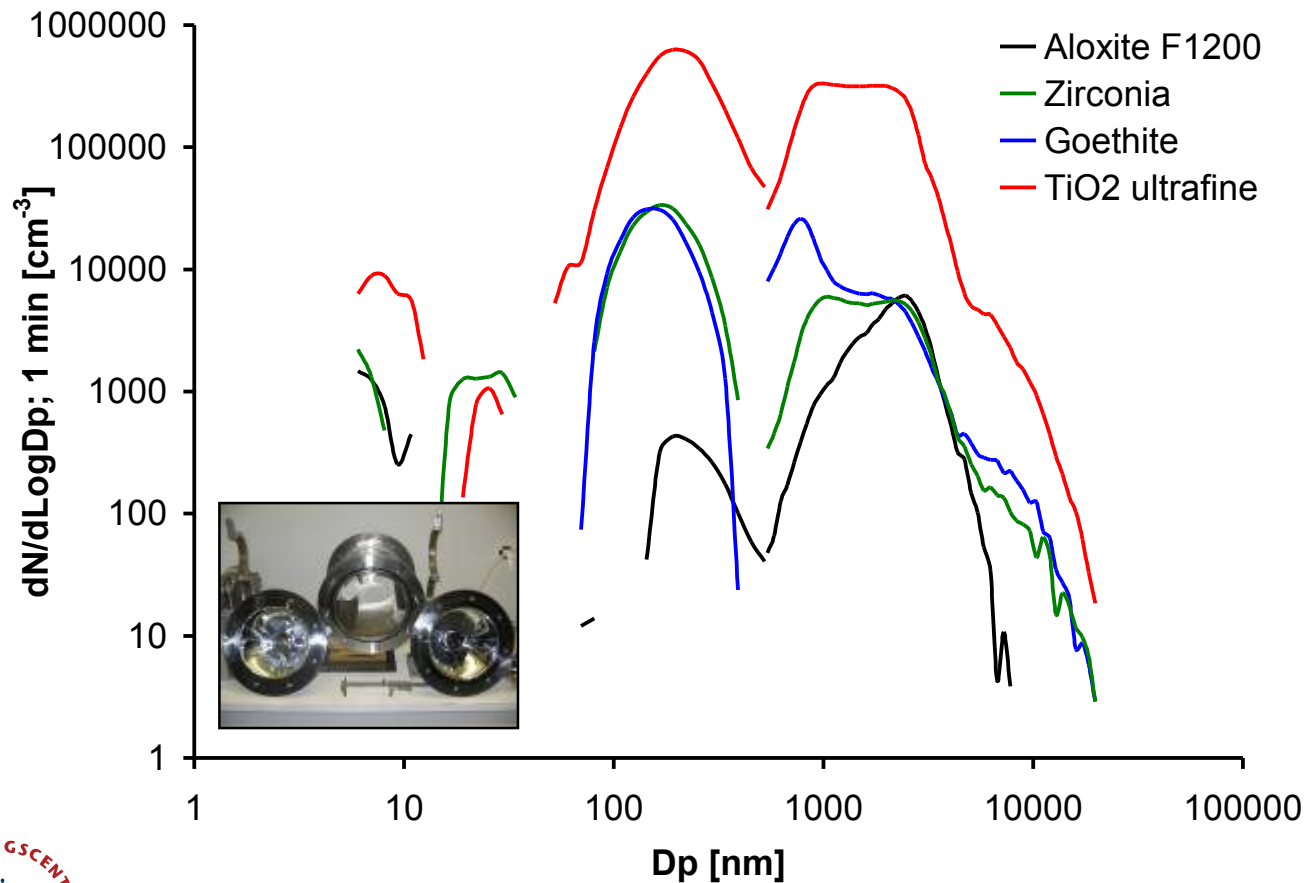

DET NATIONALE  
FORSKNINGSCENTER FOR ARBEJDSMILJØ

# Size-distributions and maximum relevant size?

## - Nano-Objects Aggregates and Agglomerates -

Respirable Fraction

Biological relevant size fraktionen (CEN, 1992)

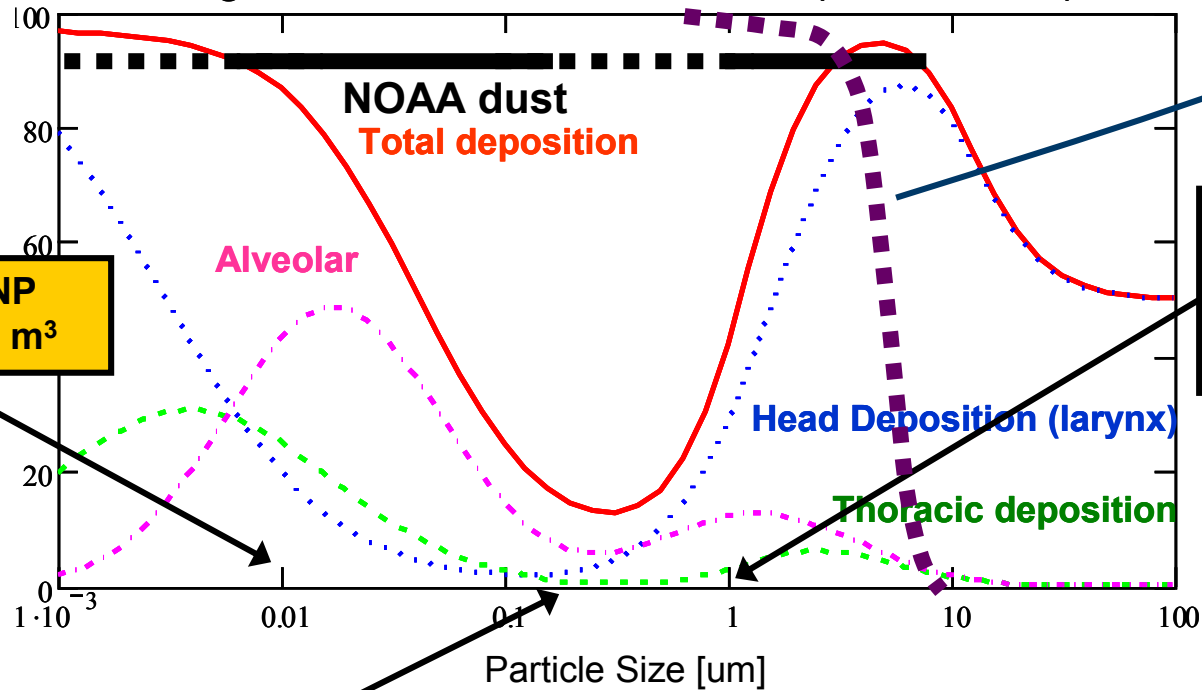

One 10 nm NP  
Vol  $5.24 \cdot 10^{-25} \text{ m}^3$

$1 \cdot 10^6$  NP's in one 1  $\mu\text{m}$  agglomerate of 10 nm NPs  
Vol  $5.24 \cdot 10^{-19} \text{ m}^3$

8000 NP's in one 200 nm agglomerate of 10 nm NPs  
Vol  $4.19 \cdot 10^{-21} \text{ m}^3$

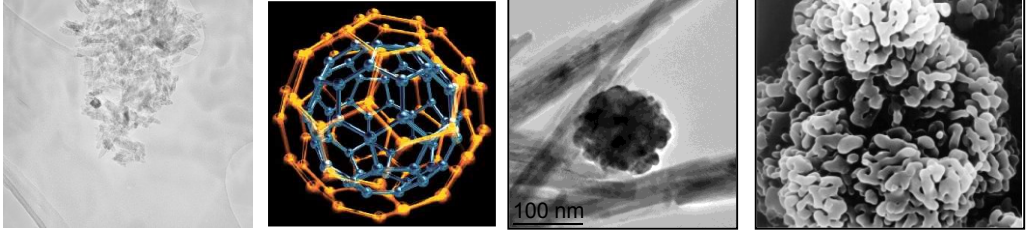

# Added value of online particle concentration measurements (Particle Generation Rate)

Schneider and Jensen AOH (2008)

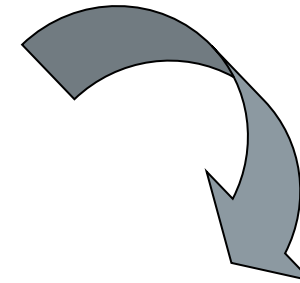
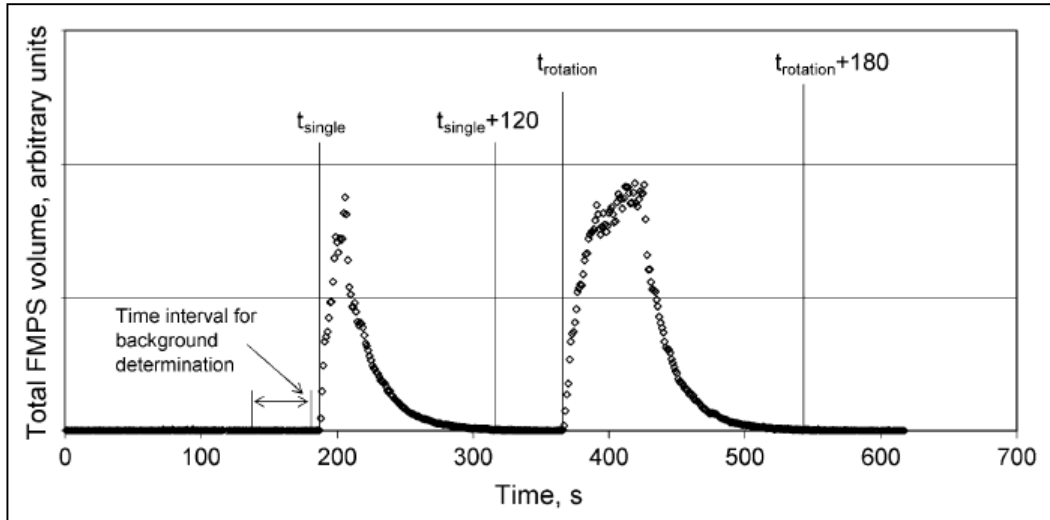

$$PGR_i = k\Delta t^{-1}(C_i - C_{i-1}\exp(-\Delta t\tau^{-1}))$$

$K$  = volume of drum

$C_i$  = volume concentration

$\Delta t$  = integration time

$\tau$  = time constant for calculation (20 sec)  
(measured value)

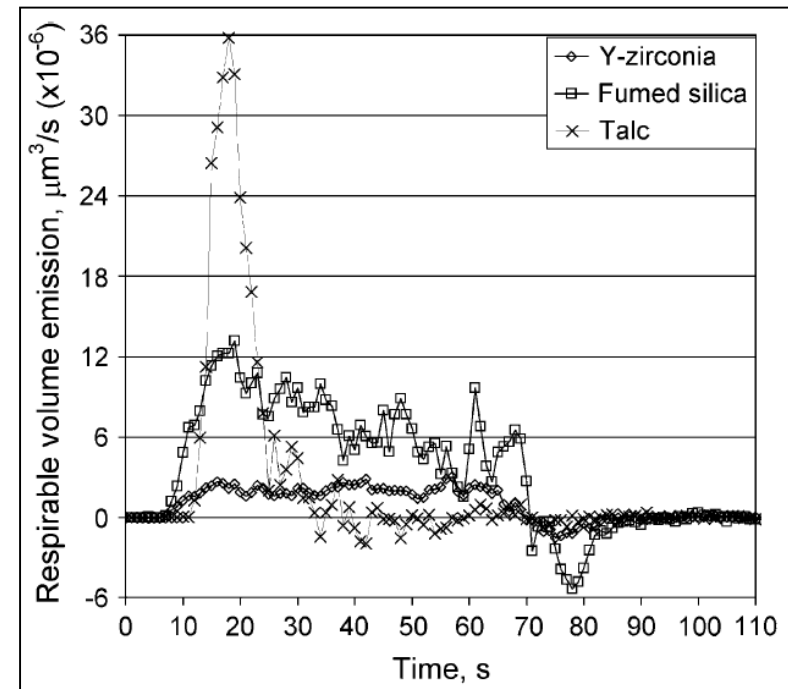

DET NATIONALE  
FORSKNINGSCENTER FOR ARBEJDSMILJØ

# Example of use of dustiness data for material decision making

Levin et al. JOEH (2014)

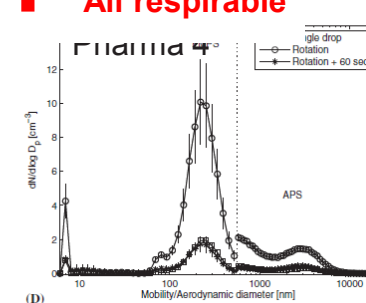
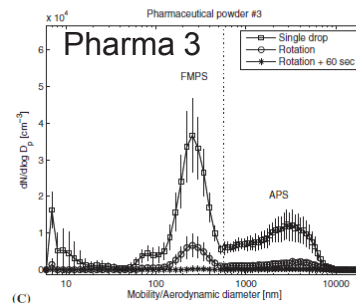
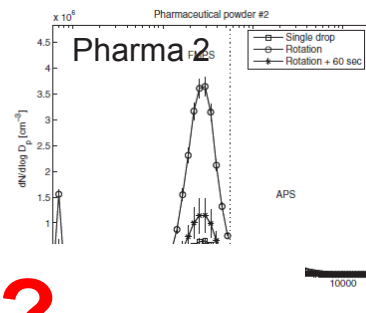
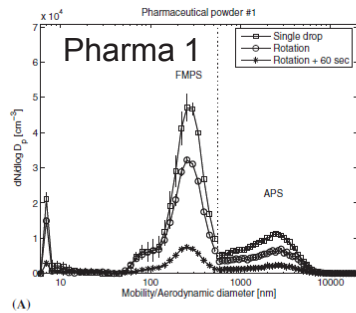
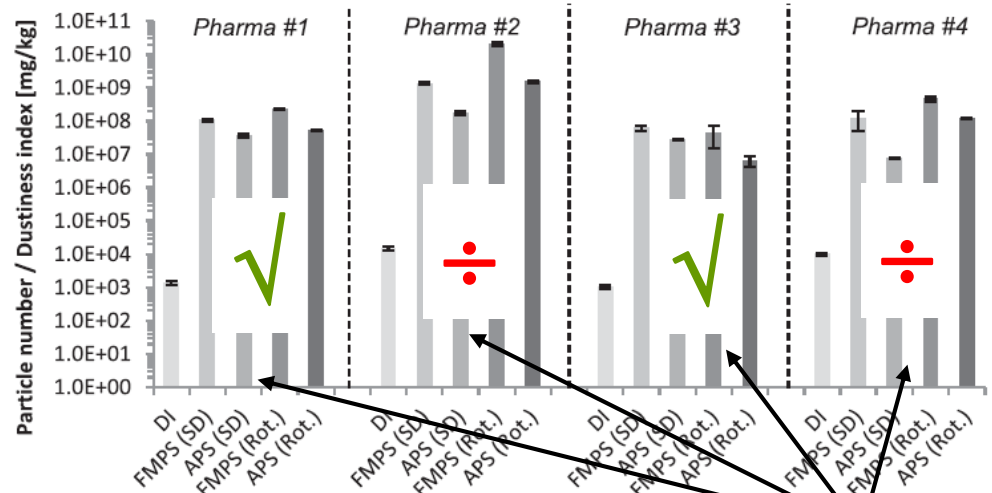
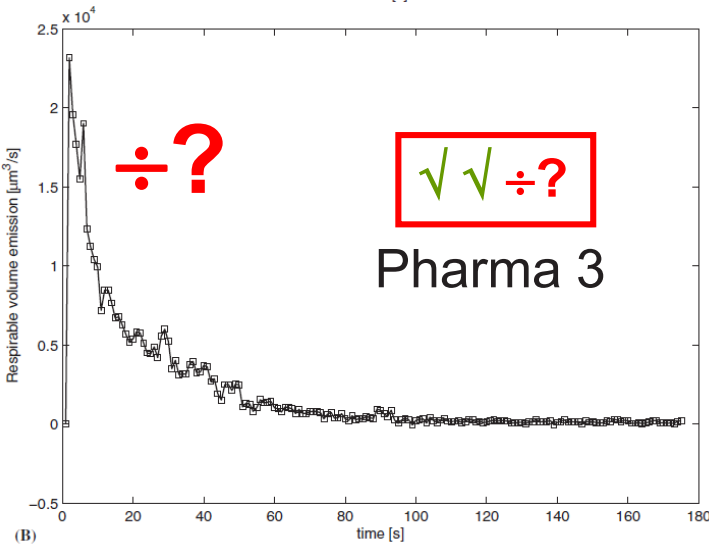
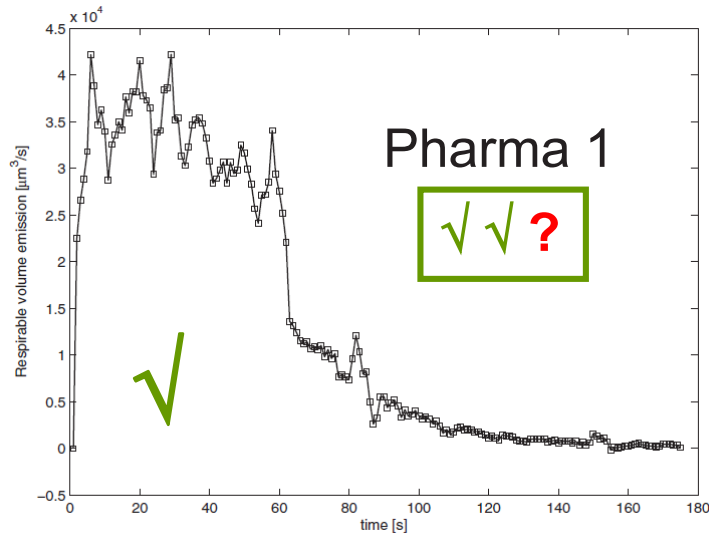

**?** All respirable

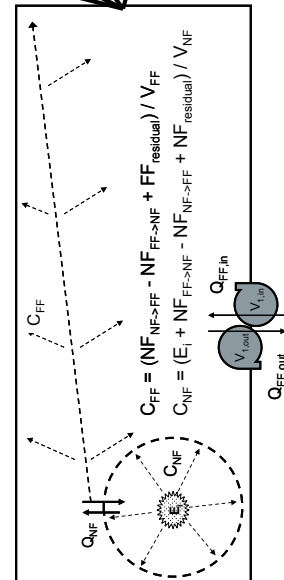

# Conclusions

- Existing dustiness categories as for example derived for ECETOC TRA, EMKG-EXPO Tool, and the classes in EN15051, appears to be too crude to cover nanopowder dustiness indices. Absolute measured values are preferred.
- Size-distribution measurements give highly valuable information for specific assessments of the potential inhalation dose and potential aerosol dynamics (there is a huge difference in filtration and aerosol dynamic behavior with particle size)
- Data on dustiness “dustiness kinetics” (particle generation rate) give further insight into powder behavior and dust release mechanisms during mechanical agitation.
- Dustiness indices, number size-distributions, and dustiness kinetics (particle generation rates) appears to be very suitable parameters for prioritization in safer material selection and assessing potential exposure during powder handling (demonstrated in Levin et al., JOEH. 2014).



DET NATIONALE  
FORSKNINGSCENTER FOR ARBEJDSMILJØ