



U.S. DEPARTMENT OF  
**ENERGY**

Office of  
Science

---

# Fermilab activities and future U.S. vision

Joe Lykken

LPC Workshop “Next Steps in the Energy Frontier”

August 25-28, 2014

# Fermilab is a special place

---



# Fermilab is America's particle physics and accelerator laboratory

Our vision is to solve the mysteries of matter, energy, space and time for the benefit of all. We strive to:

- lead the world in neutrino science with particle accelerators
- lead the nation in the development of particle colliders and their use for scientific discovery
- advance particle physics through measurements of the cosmos

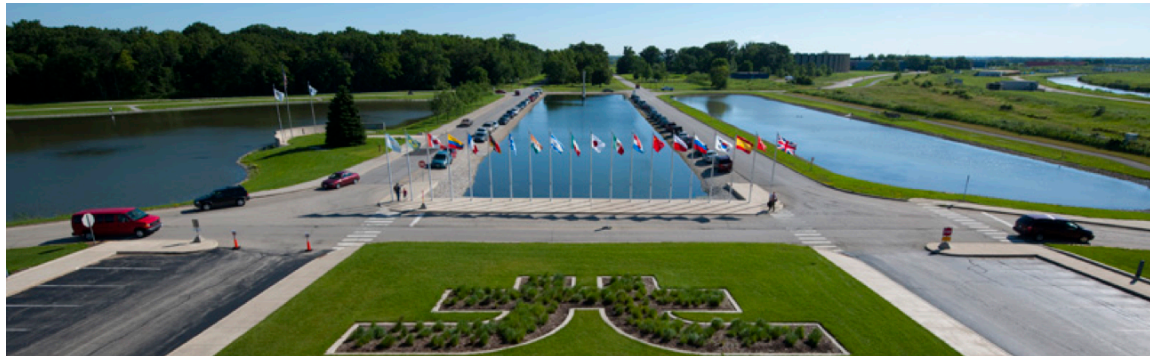

# Fermilab is America's particle physics and accelerator laboratory

Our mission is to drive discovery by:

- building and operating world-leading accelerator and detector facilities
- performing pioneering research with national and global partners
- developing new technologies for science that support U.S. industrial competitiveness

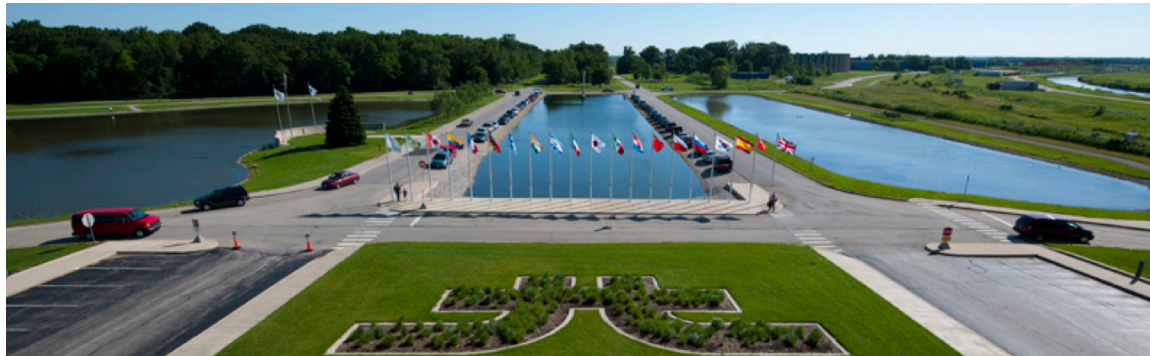

# Fermilab accelerators

- Largest accelerator complex in the U.S., the second largest in the world
- 16 km of accelerators and beamlines
- World's most powerful neutrino beams
- Leading the world in superconducting accelerator magnet technology
- Leading the world in superconducting RF acceleration technology

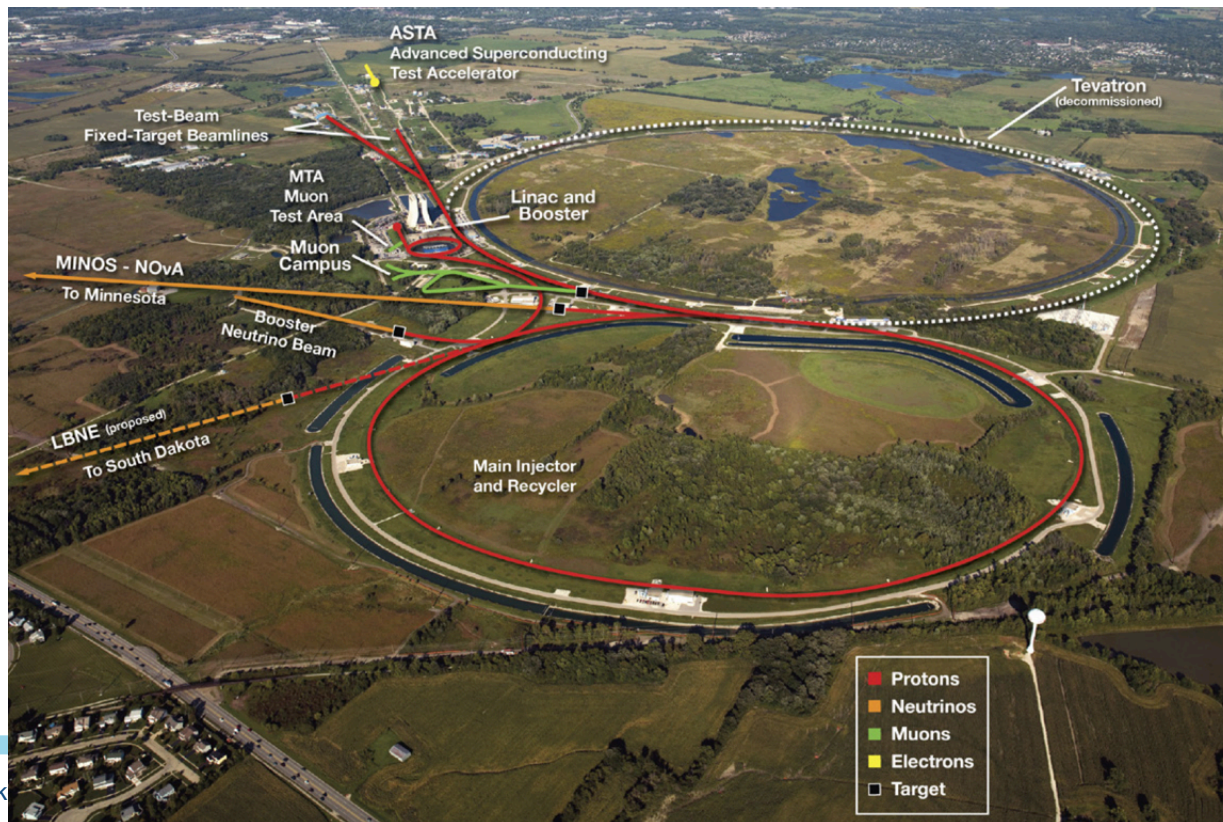

# Fermilab history

- Three elementary particles discovered at Fermilab, many other firsts
- For a quarter century, until 2009, the Tevatron was the world's highest energy collider

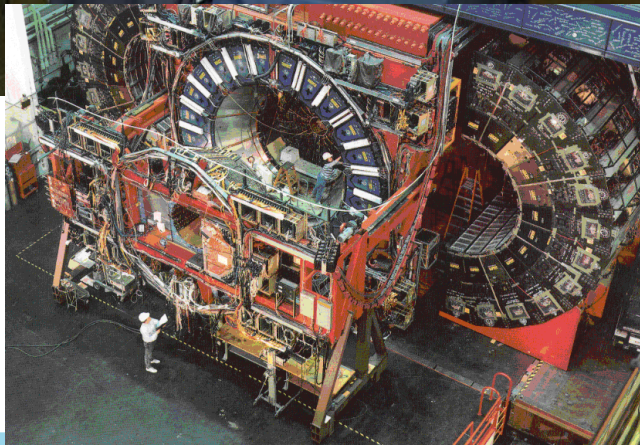
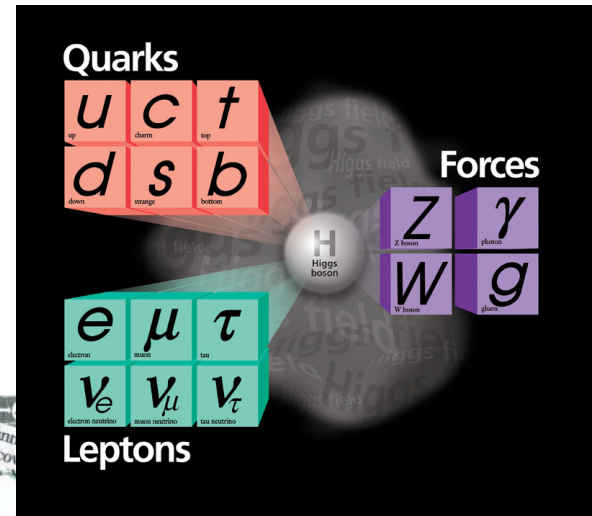

## A Year Ago.....

---

- U.S. HEP community did not have viable roadmap for its future
- Snowmass study identified a suite of projects and proposals in excess of \$8B over the next decade
- U.S. HEP community needed to get behind a new plan

# Fermilab's Input to P5...Guiding Criteria

---

- Principles adhered to:
  - Launch the best accelerator-based neutrino program possible
  - Strengthen the accelerator complex because this is what we provide to the community
  - Provide a platform for LHC & future colliders
    - High-field magnet technology (Nb<sub>3</sub>Sn and High Tc)
    - Advance SRF technology
  - Pursue dark matter & dark energy
  - Provide scientific computing big data tools for community
  - Strengthen core detector infrastructure
  - Partner with Office of Science labs, universities, international
- Fermilab established a working group of its senior scientists to provide “Our Vision” as input to P5



## P5 process

---

- The Snowmass community-planning process fed into the P5 prioritization process and P5 came up with a roadmap
- U.S. particle physicists got behind P5 report – a letter of endorsement with >2,200 signatures from HEP community
- Field made tough choices based on its scientific priorities



# Building for Discovery

Strategic Plan for U.S. Particle Physics in the Global Context

Report of the Particle Physics Project Prioritization Panel (P5)



Higgs boson

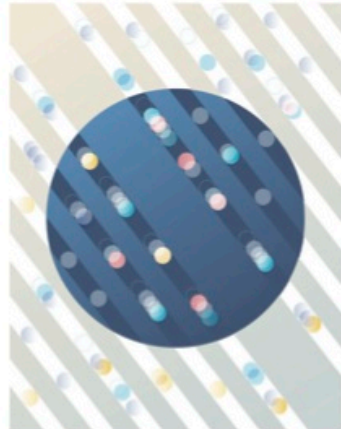

Neutrino mass



Dark matter

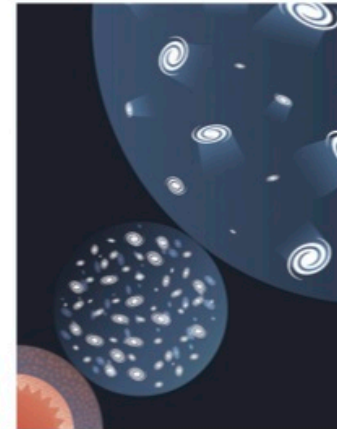

Cosmic acceleration

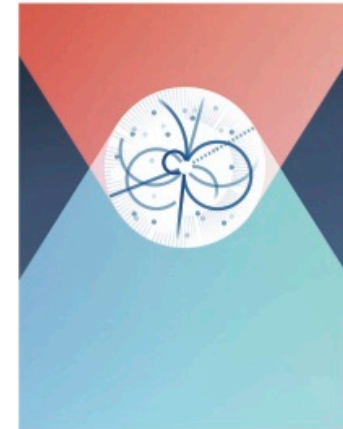

Explore the unknown



## Fermilab Science Strategy aligned to P5 Plan

---

- Drive Large Hadron Collider research and upgrades
- Build a world-leading neutrino program
- Upgrade the accelerator complex to meet future needs
- Launch a muon physics program
- Advance our understanding of dark energy, dark matter, and the cosmic microwave background
- Leverage accelerator expertise and infrastructure for the benefit of science and society



# Building for Discovery

Strategic Plan for U.S. Particle Physics in the Global Context

# Fermilab and CMS

- Fermilab is the headquarters of US CMS: operations, detector building, computing
- US CMS is ~1,000 physicists, students, computer professionals
- 49 universities in 23 states
- Fermilab CMS group is ~100 people, add another ~700 users of Fermilab CMS computing
- Fermilab LPC provides critical mass intellectual center for >350 users



# Fermilab and CMS

## An Integrated System and Getting Plugged in!

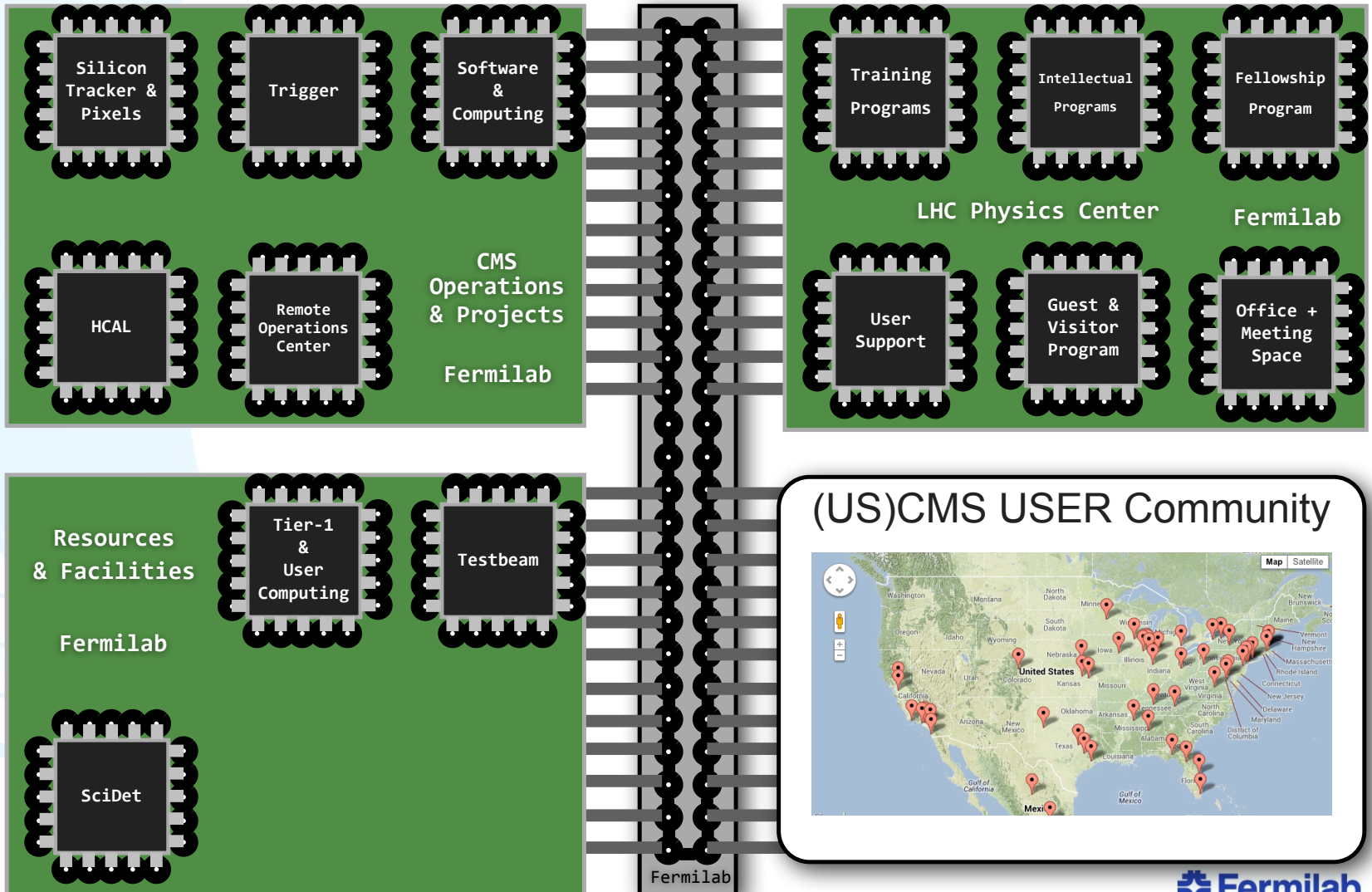



- **Science goal:** Measure Higgs properties; search for new particles and forces, including supersymmetry.
- **Recent publications:** Higgs width, dark matter and supersymmetry searches, Top mass measurement,  $B_s \rightarrow \mu\mu$
- **Upcoming milestones:** LHC startup in 2015 at higher energy

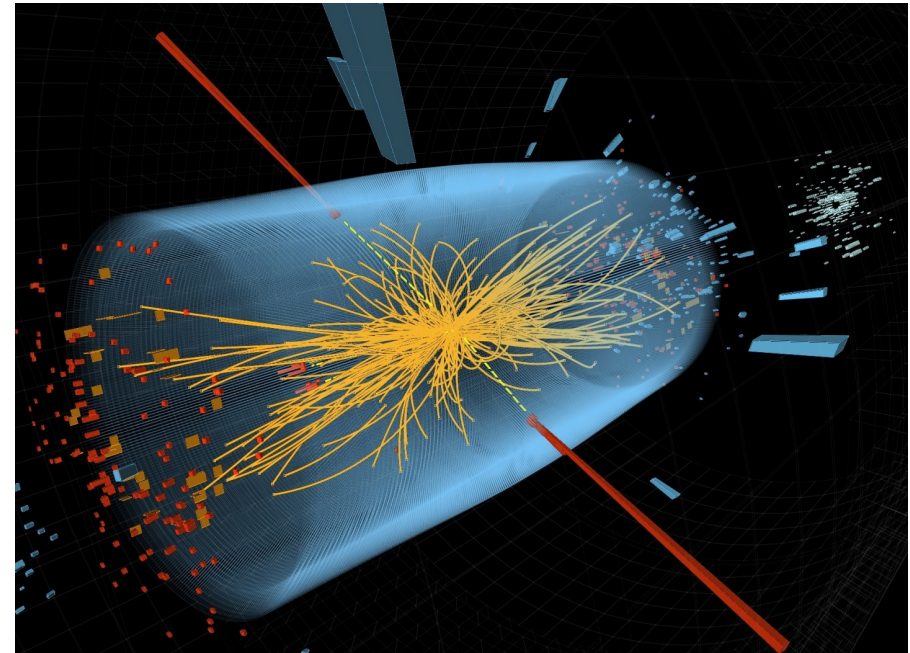

Status: Run 1 completed and many analyses published; LHC in shutdown period; Run 2 to start in 2015

Run duration: LHC Run 2 from 2015 through mid-2018

Partnerships: DOE/NSF program

U.S. universities: 47

International: CERN + 130 institutes

LHC Physics Center

# Higgs connections

- Does the Higgs destabilize the vacuum?
- Is there a Higgs portal to dark matter?
- How does the Higgs boson talk to neutrinos?
- Is the Higgs responsible for the baryogenesis in the early universe?
- Extra credit: is the Higgs related to cosmic inflation or dark energy?



# Phase I Upgrades

Higgs boson, Dark matter, Explore the unknown



- **Science goal:** Exploit the opportunity at the LHC to explore the Energy Frontier
- **Technical challenge:** Create new HCAL front end and backend, Forward Pixel, and L1 Trigger system within the constraints of the LHC schedule while simultaneously operating the current detector
- **FY14 highlights:** Completion of design/prototype phase and Initiation of the fabrication phase

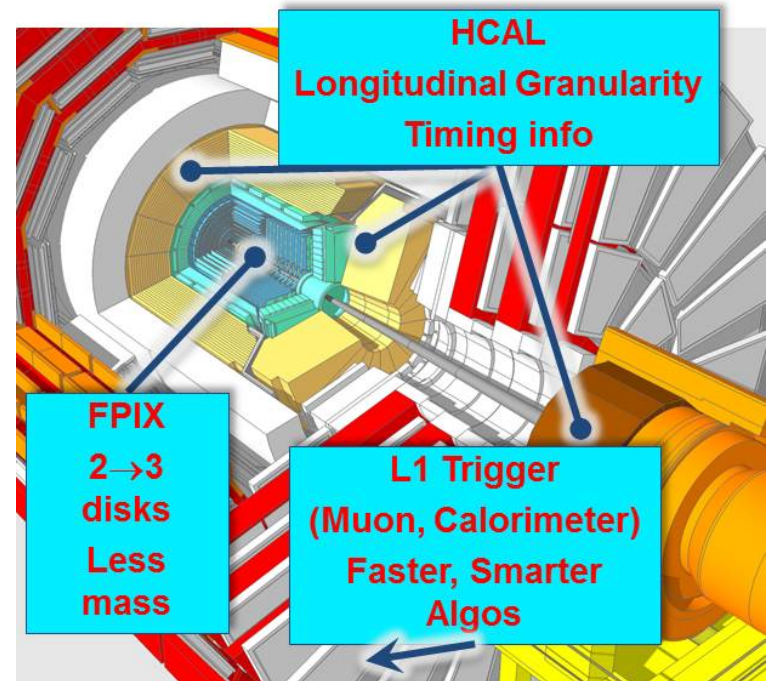

**Status: Passed CD-2/3 Review**

Operations start: 2016-2018

Run duration: ~10 yrs (then HL-LHC)

Agencies: DOE, NSF

DOE labs: FNAL

U.S. universities: 30

International: CERN + 130 institutes







- **Science goal:** Discovery of new physics, measurement of Higgs boson properties
- **Technical challenge:** Design of a silicon tracker integrated with a L1 trigger and an endcap calorimeter to operate in the high luminosity environment of the HL-LHC.
- **FY14 highlights:** Start up of the Phase 2 R&D program.

Scope to be negotiated

Status: R&D begun; CD-0 in FY16 and aim for construction start in FY18

Operations start: 2025 (after LHC Long Shutdown 3)

Run duration: HL-LHC run 10 years

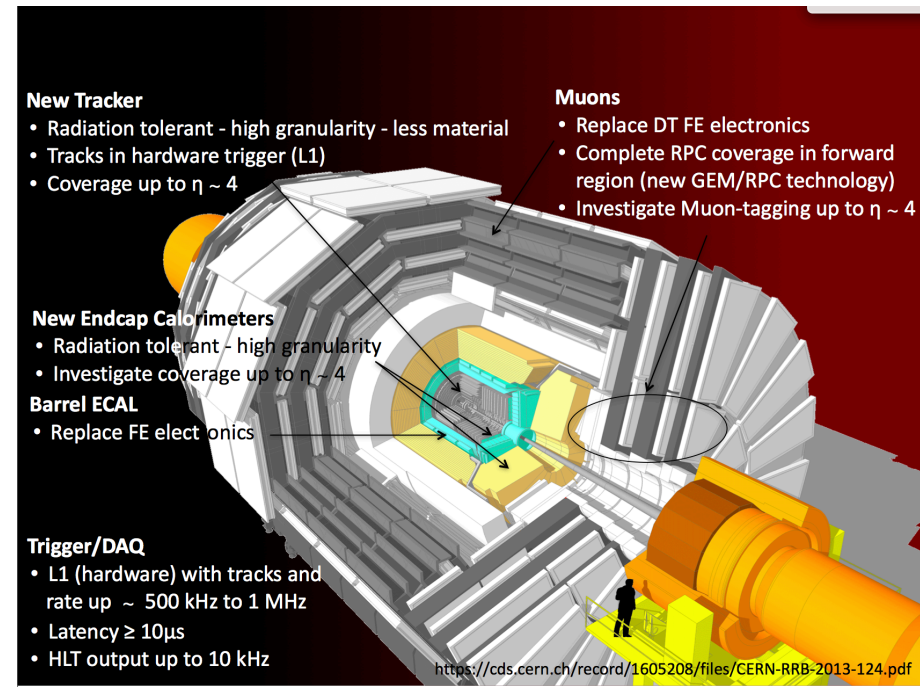

Partnerships: DOE, NSF (proposed)

DOE Labs: FNAL

U.S. universities: 47

International: CERN + 130 institutes

# Fermilab accelerator magnets for LHC

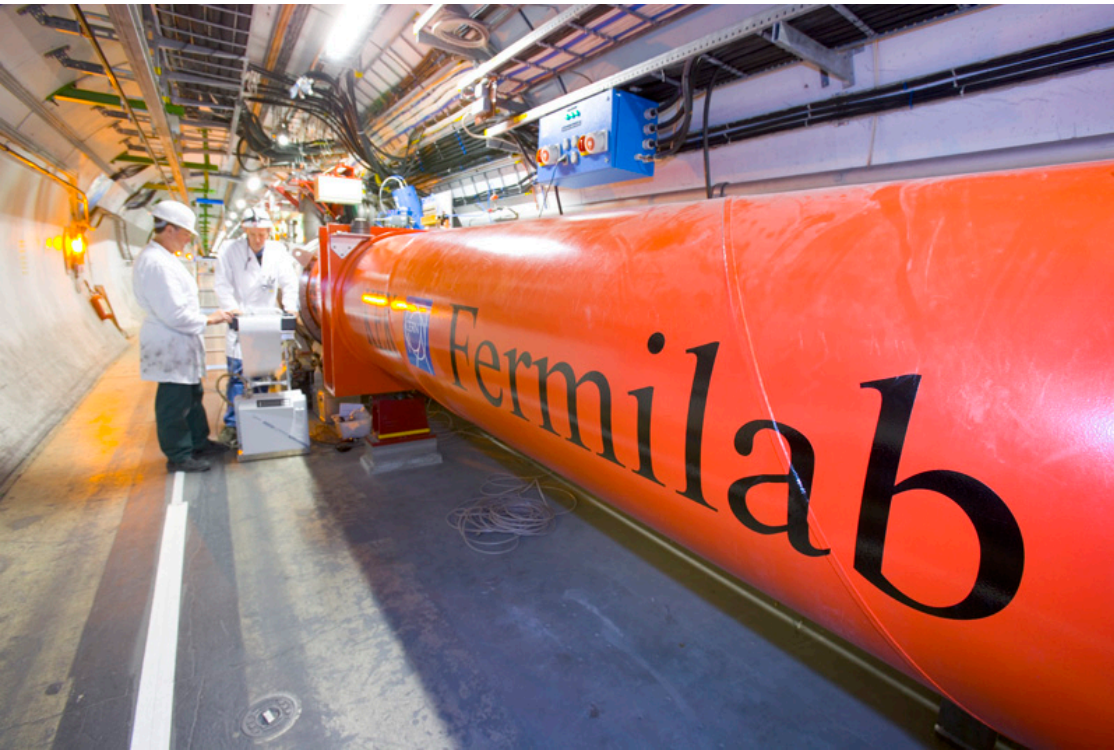



- **Science goal:** Contribute with leading-edge technology ( $\text{Nb}_3\text{Sn}$  magnets and possibly crab cavities) to the HL-LHC ( $3,000 \text{ fb}^{-1}$  per experiment)
- **Technical challenge:** Develop first accelerator-quality  $\text{Nb}_3\text{Sn}$  focusing quadrupoles.
- **FY14 highlights:** Consistently reached 170 T/m in recent models. Essential means to high luminosity for LHC.

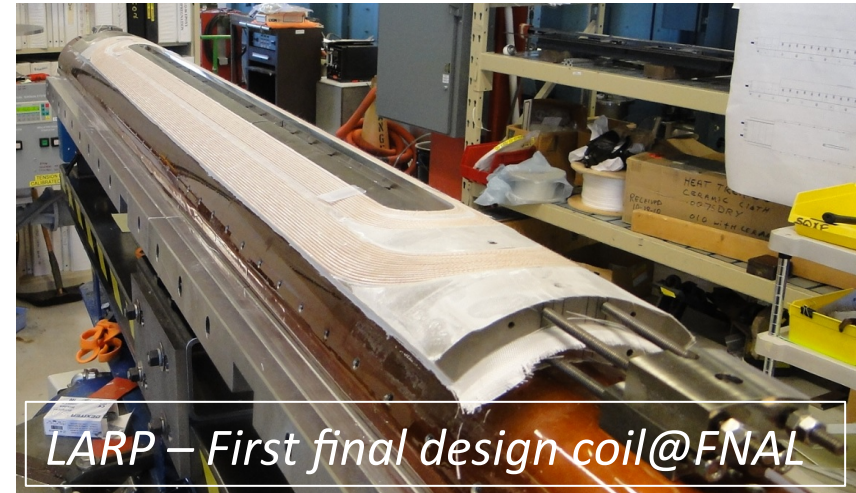

TPC: LARP \$48M, HL-LHC scope to be negotiated

Status: pre-CD-0 (LARP Phase)

Operations start: 2019, 2025

Run duration: ~10 years

Partnerships

DOE labs: BNL, LBL, SLAC, JLab

International: CERN

# FCC

- Future CERN Collider?
- Future China Collider?
- Future Chicago Collider?

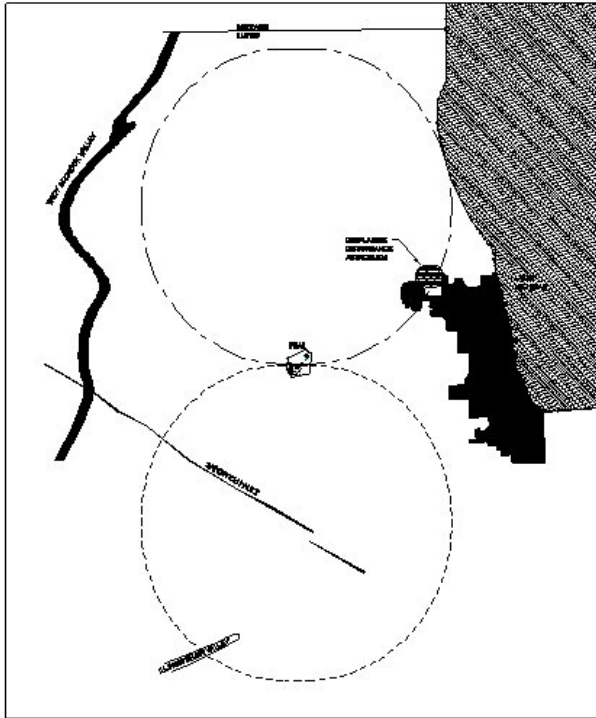

Fermilab strategy is to push R&D in key areas where we already have leading expertise

# What else is happening at Fermilab?





- **Science goal:** Measure g-2 of the muon four times more precisely than previous experiments to search for new physics
- **Technical challenge:** Obtaining high field uniformity, delivering new muon beam, measuring muon spin precession to sub-ppm
- **FY14 highlights:** Ring transport from BNL; building complete; cryo plant began construction

Status: CD-2/3 coming soon  
Operations start: March 2017  
Initial run duration: 2-3 years



## Partnerships

DOE labs: ANL, BNL

U.S. universities: 16

International: 8 countries, 17 institutions

- **Science goal:** Discover charged-lepton-flavor-violation by improving sensitivity by  $10^4$
- **Technical challenge:** Design and fabricate unique superconducting solenoid system and world's most intense muon beam
- **FY14 highlights:** Completed conductor R&D for procurement (CD-3a), solenoid reference designs, and specified detector technologies

Status: Seeking CD-2/3b approval  
Operations & Commissioning: 2020  
Initial run duration: 5 years

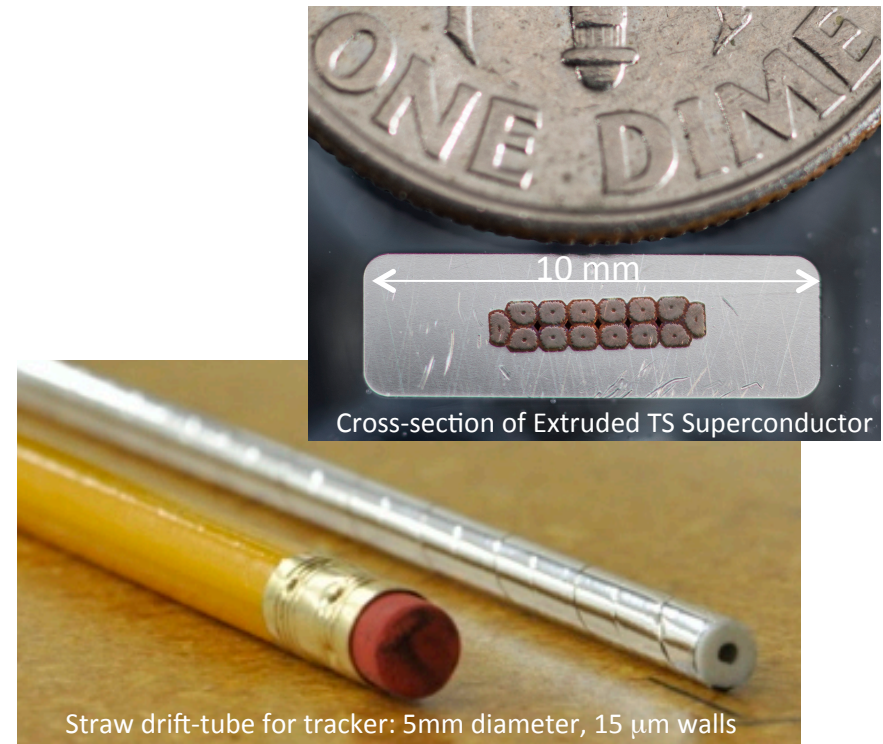

## Partnerships

DOE labs: ANL, BNL, LBNL

U.S. universities: 16

International: 3 countries, 8 institutions

- **Science goal:** For different  $\delta_{CP}$  ranges: determine mass hierarchy, determine  $\theta_{23}$  octant, constrain allowed range of  $\delta_{CP}$  .  
Measure  $\sin^2(2\theta_{23})$  to  $\sim 4\%$ .
- **Technical challenge:** Finish outfitting detectors with APDs.
- **FY14 highlights:** 14 kiloton far & 294 ton near detector assembly done, filled with 2.7 M gal liquid scintillator.

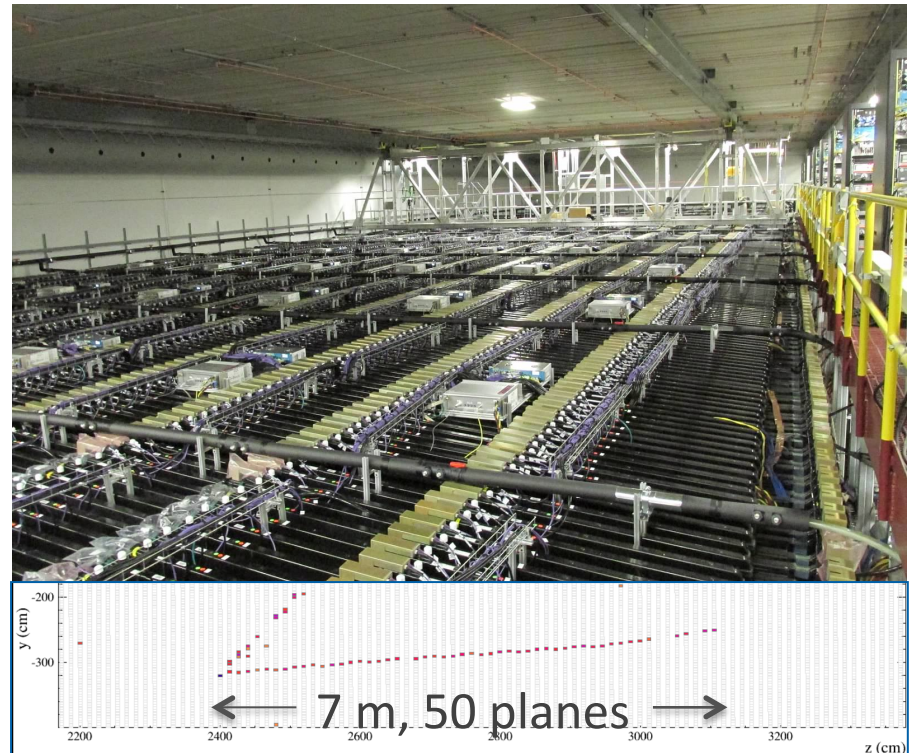

Status: CD-4 Sep 2014

**Operations start: Now!**

Run duration: 6 years @ 700 kW

Partnerships

DOE labs: ANL

U.S. universities: 19

International: 6 countries, 14 institutes

 Fermilab



- **Science goal:** Determine the nature of the MiniBooNE low energy excess of electron neutrinos
- **Technical challenge:** Operate a LArTPC with 2.5m drift, cold electronics, and purity without evacuation
- **FY14 highlights:** Completed construction of the TPC, electronics, and cryogenics

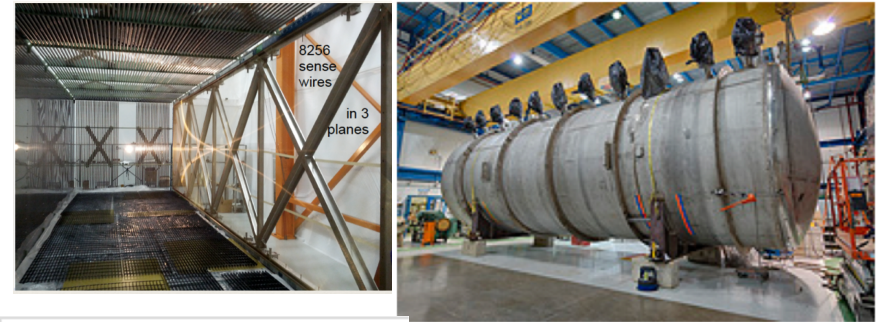

Status: CD-3 (Commissioning fall)

**Operations start: Jan 2015**

Run duration: 3+ years

Partnerships

DOE labs: BNL, LANL, SLAC

U.S. universities: 13

International: 3 countries, 5 institutes

# Short-Baseline Neutrino Program

- **Science goal:** Search for sterile neutrinos; definitive resolution of LSND and MiniBooNE anomalies. Continue R&D on LAr-TPC technology aligned with LBNF.
- **Technical challenge:** Design and construct near detector in <3yrs, refurbish and transport T600.
- **Status:** Meta-collaboration formed of LAr1-ND, MicroBooNE, ICARUS; CERN platform funded

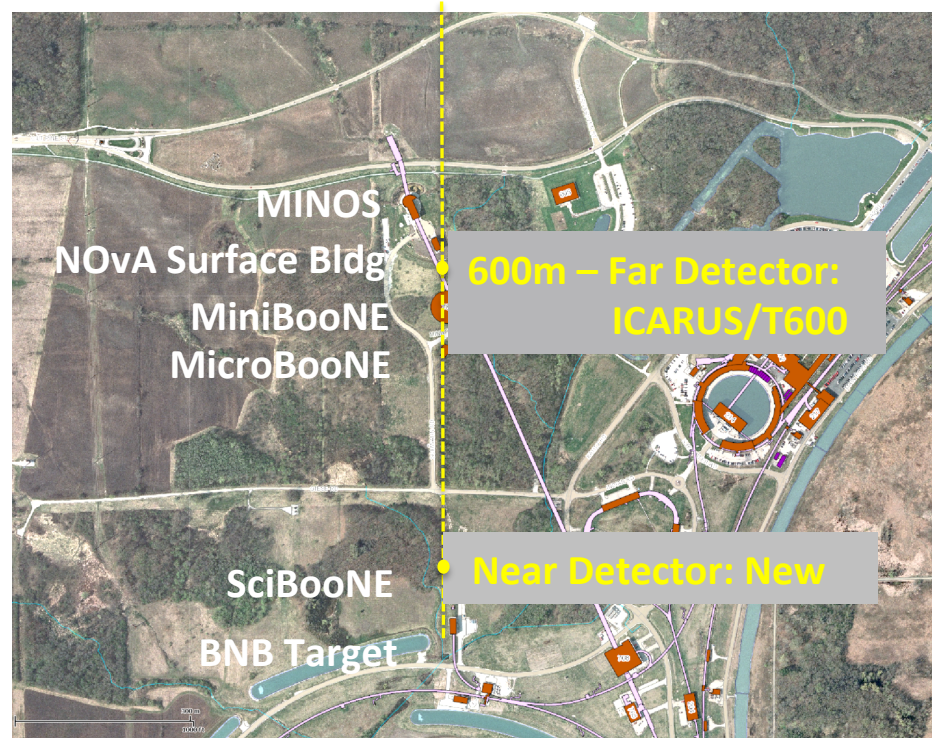

## Partnerships

DOE labs: LANL, BNL, SLAC

U.S. universities: 17

International: 24 institutes (incl. CERN)





- **Science goal:** Neutrino CP violation and mass ordering; proton decay; supernova neutrinos.
- **Technical challenge:** Massive LAr TPC deep underground; targeting MW proton beam
- **FY14 highlights:** P5 endorses a new, reformulated, comprehensive experiment designed and implemented by a new international collaboration

**50,000 ton Liquid Argon Detector**

**LBNE Liquid Argon TPC**

**GOAL: 34 kt fiducial mass**  
**Volume: 18m x 23m x 51m x 2**  
**Total Liquid Argon Mass: ~50,000 tons**

Actual detector design will be proposed by an international collaboration, and may involve multiple modules of different technologies

67 Neutrinos are Everywhere Heinz R. Pagels Memorial Lecture

Status: CD-1 (2012), CD-3 (~2017)  
 Operations start: ~2024  
 Run duration:  $\geq 20$  years

## Partnerships

DOE labs: ANL, BNL, LANL, LBNL, LLNL, SLAC

U.S. universities: 48

International: >7 countries, >34 institutes



## Long-Baseline Program process moving fast

---

- June 16: CERN Science Policy Committee (SPC) presentation...US situation and plans post-P5
  - Chairs of CERN Council & Finance Committee present
- CERN Medium-Term Plan (MTP) approved...5 year plan with next year's budget defined...\$60M for neutrinos
  - Aimed at neutrino platform to assist with program in US
  - Investment in infrastructure outside CERN
  - No funds for a CERN neutrino beam for at least 5 years
- June 21-22: APPEC Paris meeting...European neutrino physicists & agencies met to discuss future post-MTP
  - World program represented
  - Strong support for accelerator-based neutrinos in US & Japan

## Long-Baseline Program process moving fast

---

- July 14: Jim Siegrist hosted a meeting at Fermilab of funding agencies....UK, Italy, CERN, India, Brazil, Japan
  - Need to embed international components in Lehman-like process
  - Launched working group on project governance
- Forming a new international collaboration...
  - July 21-22 “Summit” at Fermilab (Ken Long & Rob Roser Co-Chairs)
  - Interim International Executive Board named, meets Sept 23-24
- ...converging of ideas in a series of meetings...and then a PAC process...
  - LOI to Fermilab to PAC this year
  - LBNF proposal to PAC by summer 2015

# Upgrading the Accelerator Complex to Meet Future Needs

---

- Fermilab is transforming its accelerator facilities, making the use of existing assets freed up by the end of Tevatron collider operations.
- The existing Fermilab accelerator complex, including the Main Injector synchrotron, Recycler storage ring, and NuMI neutrino beam line and target, have been upgraded and are on the path to supplying 700 kW proton beams by 2016
- The Proton Improvement Plans (PIP-I, PIP-II), are designed to support the operation of Fermilab's suite of neutrino and muon experiments through 2030. Plan for Booster replacement post-2025 (PIP-III)



- **Science goal:** Provide  $>1$  MW of beam power at LBNF startup; provide a platform for future high power/high duty factor capabilities (e.g. Mu2e up to 100 kW)
- **Technical challenge:** High-performance beam source; high-efficiency SRF acceleration
- **Longer term:** pathway to multi megawatt beams at Fermilab

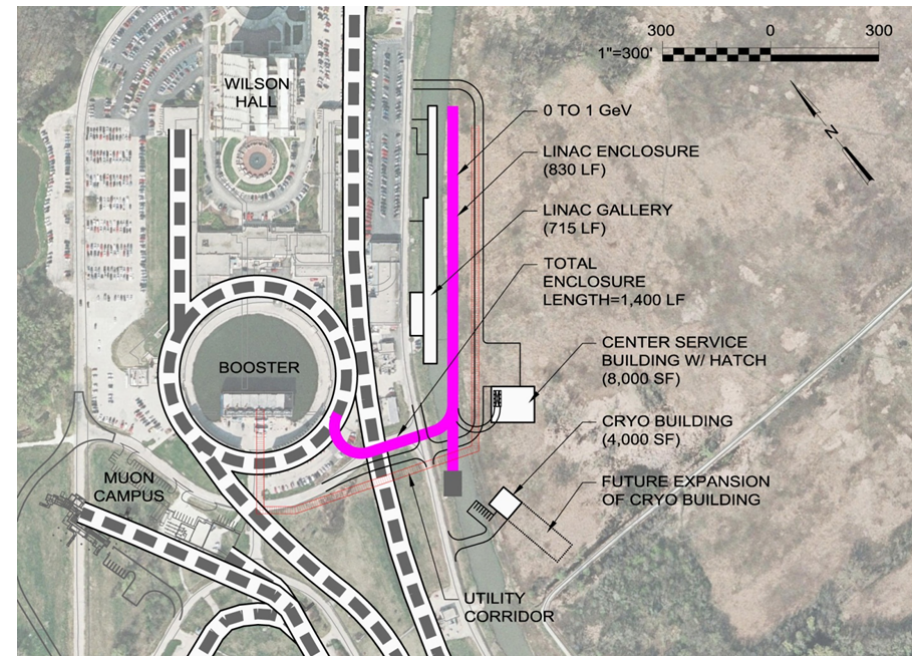

Status: R&D

Operations start: FY2024

Run duration:  $>20$  years

Partnerships

DOE labs: ANL, LBNL, ORNL

U.S. universities: Cornell, NIU

International: 2 countries, 5 labs

# Dark Energy, Dark Matter, and the CMB

---

- Fermilab's DES is the leading program in the world to investigate the unknown energy that makes up most of the total energy content of the universe.
- Fermilab is a leader in the worldwide hunt for dark matter
- Looking toward the future, Fermilab is contributing scientific and technical expertise to the Dark Energy Survey Instrument (DESI) and is a member of the Large Synoptic Survey Telescope (LSST) collaboration.
- In 2013 Fermilab, along with partner labs, commenced involvement in third- and fourth-generation experiments to study the cosmic microwave background polarization.





- **Science goal:** Probe dark energy via clusters, lensing, supernovae, large-scale structure
- **Recent publications:** Weak lensing cluster masses, photometric redshifts, superluminous supernova, cross-correlation with CMB
- **Upcoming milestones:** papers on discovery of high-redshift clusters, supernovae, large-scale weak lensing in coming months

Status: 2<sup>nd</sup> season starting now

Run duration: at least through Feb. 2018 (Five 105-night seasons)

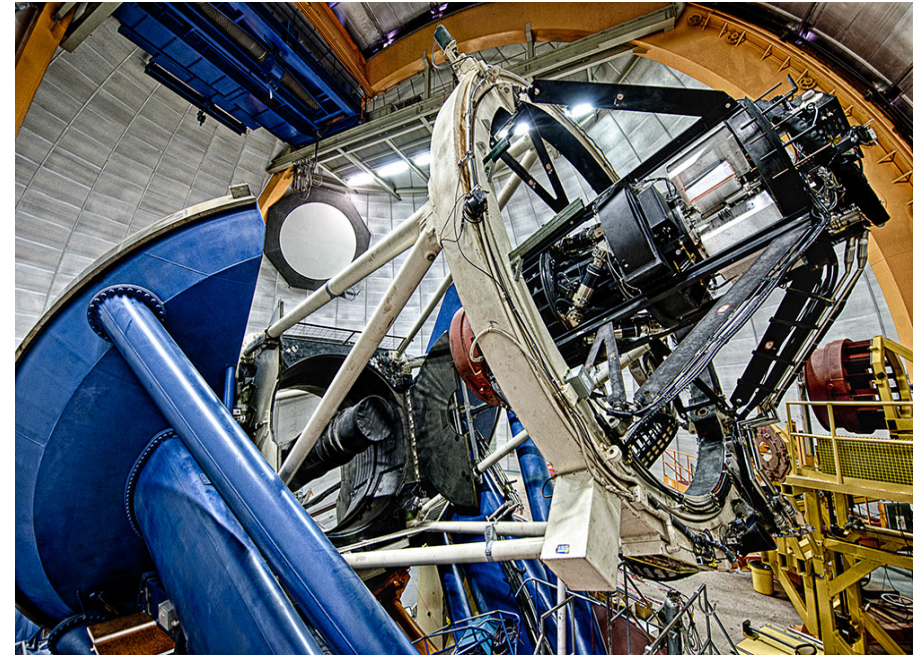

## Partnerships

DOE labs: FNAL, ANL, SLAC, LBNL

NSF, NOAO, NCSA

U.S. universities: 9

International: 5 countries, 12 institutes  
 Fermilab



- **Science goal:** Directly detect dark matter particles, search for non-standard particles
- **Recent publications:** Background performance of SuperCDMS iZIPs; low-mass dark matter limits with CDMSlite and with iZIPs
- **Upcoming milestones:** Background-free dark matter search from SuperCDMS Soudan

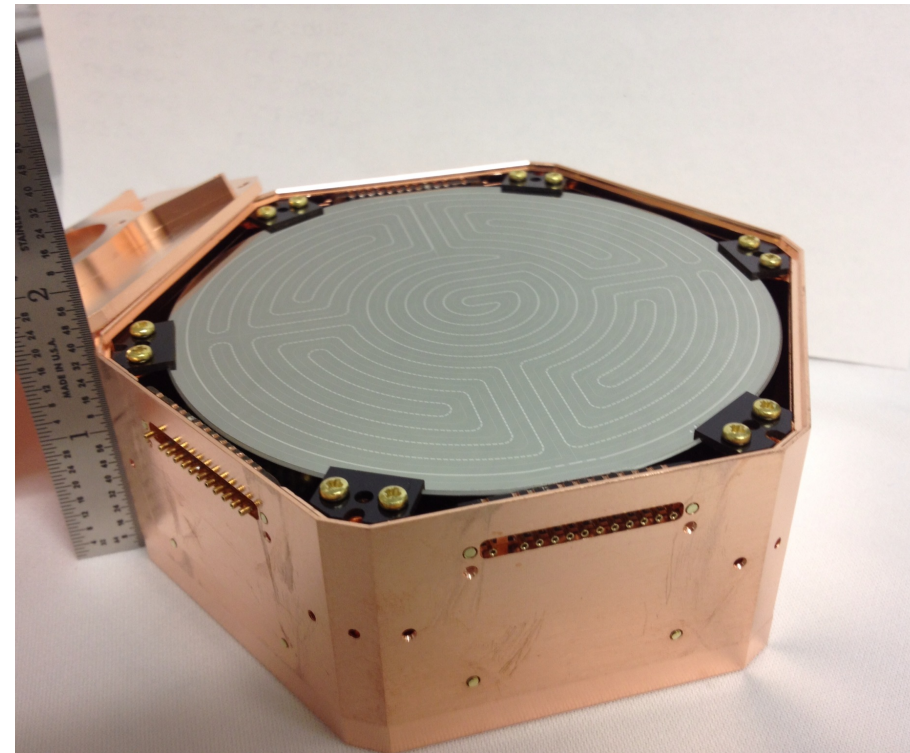

Status: Operating SuperCDMS Soudan; designing SuperCDMS SNOLAB (G2 dark matter)

Run duration: Soudan (2015), SNOLAB (2020)

Partnerships

National Laboratories: 3

U.S. universities: 13

International: 4



- **Science goal:** Probe  $\sim 10^{16}$  GeV physics during cosmic Inflation; measure sum of the neutrino masses; constrain dark radiation
- **Technical challenge:** Scaling of superconducting detector arrays to  $\sim 500,000$  pixels
- **FY14 highlights:** Endorsement by P5 and HEPAP; CMB B-mode polarization detected by Stage 2 experiments

Status: Seeking CD-0 approval

Operations start:  $\sim 2022$

Run duration:  $\sim 5$  years

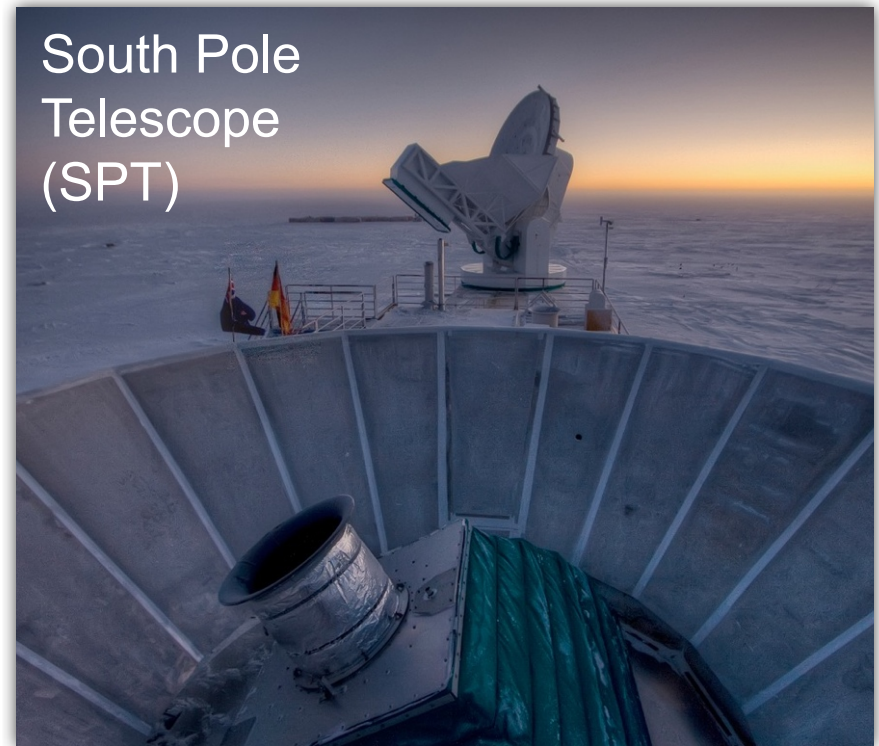

Partnerships

DOE labs: ANL, FNAL, SLAC, LBNL

U.S. universities:  $\sim 20$

International:  $\sim 6$



- **Science goal:** measure the cosmic distance scale over nearly the entire age of the Universe, constrain neutrino masses and inflation.
- **Technical challenge:** 1m diameter lenses, 5000 robotic fiber positioners
- **FY14 highlights:** 1<sup>st</sup> spectrograph ordered, optical design finalized, 1st lens orders placed, fiber positioner selected

### DESI

- 5000 fibers in robotic actuators
- 10 fiber cable bundles
- 3.2 deg. field of view optics
- 10 spectrographs

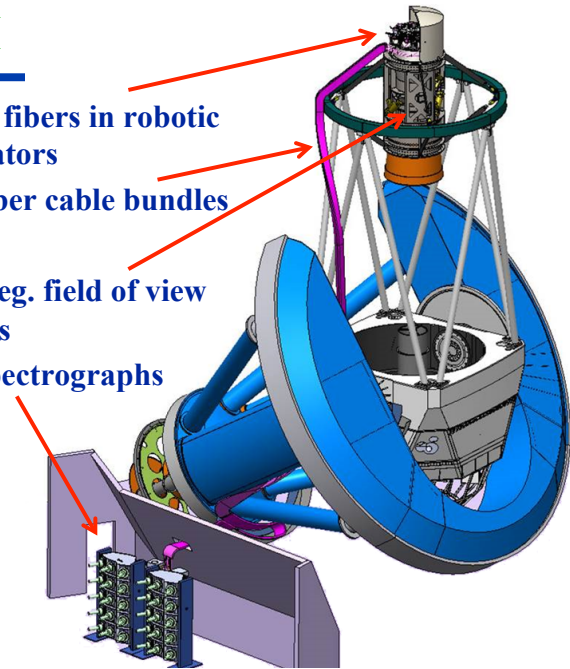

Mayall 4m  
Telescope  
Kitt Peak  
Tucson, AZ

Status: CD-1 Review Sept. 2014  
(Ready for FY15 MIE start)

Operations start: 12/2018

Run duration: 5 years

Partnerships (currently forming):

DOE Labs: LBNL (Lead Lab), FNAL,  
SLAC, ANL, BNL

U.S. Universities: 21

International Institutions: 19



# LCLS-II Activities at FNAL

- Work on High Q0 development
  - Goal is to establish that the parameter choice of  $2.7 \text{ E}10$  (in production) is valid, and that the cryoplant design capacity is adequate
  - Breakthrough for SRF-based accelerators (lowers cost to operate)
- Design, fabricate, test 17 1.3 GHz + two 3.9 GHz cryomodules
  - Fermilab has sole responsibility for 3.9 GHz cryomodule
- Design & fabricate cryogenic distribution system

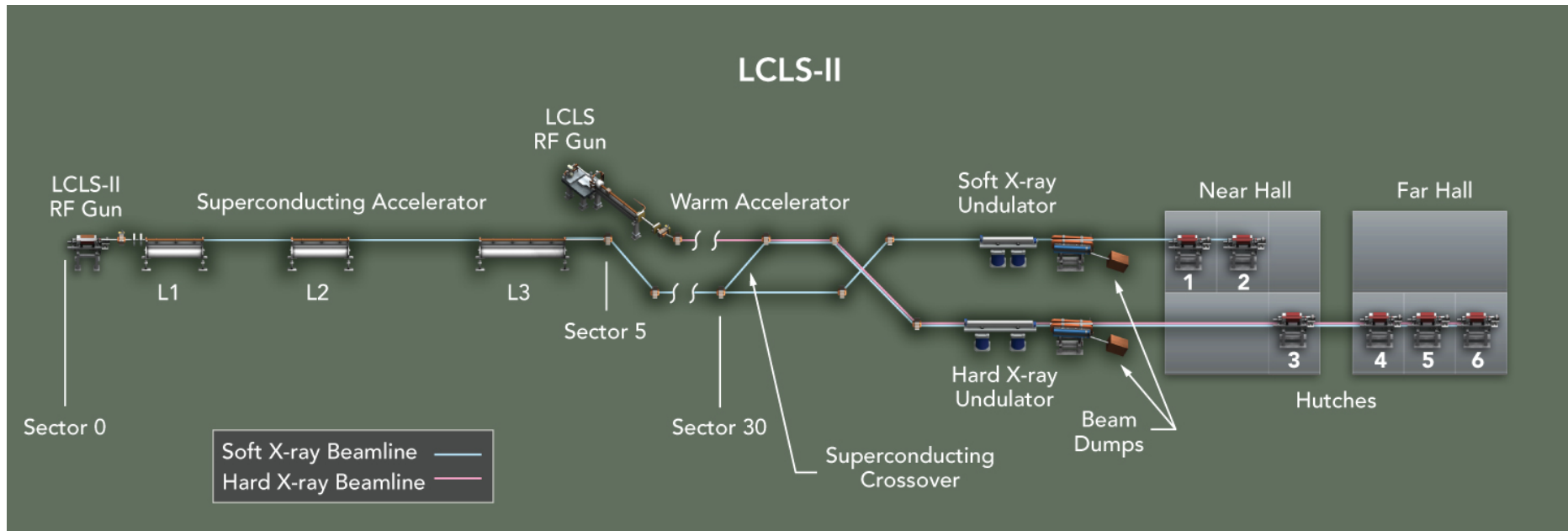

# Superconducting RF Cryomodule

Explore the unknown 

- **Science goal:** Experimentally demonstrate high-gradient high-efficiency beam acceleration with an SRF ILC-type cryomodule
- **Technical challenges:** Nb cavity surface quality via series of processing steps; high-Q resonance control in presence of microphonics noise; beam loading compensation
- **FY14 highlights:** 8 cavity 1.3GHz SRF cryomodule commissioned at world record 31.5 MV/m gradient

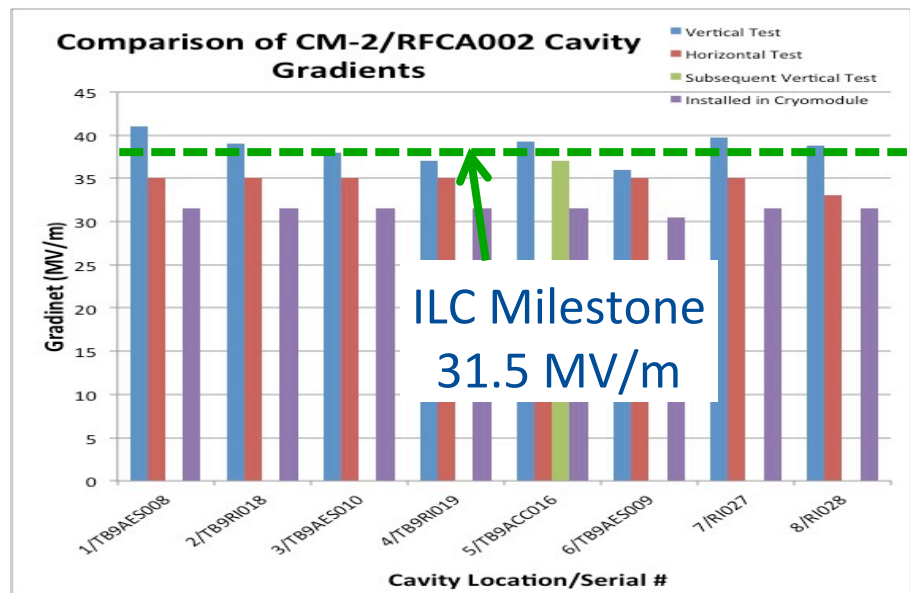

Status: System tests without beam  
Operations start: late 2015 (with beam)  
Run duration: 3-5 years  
Partnerships: SLAC, ANL, JLab

# Recent Breakthrough with Superconducting Cavities

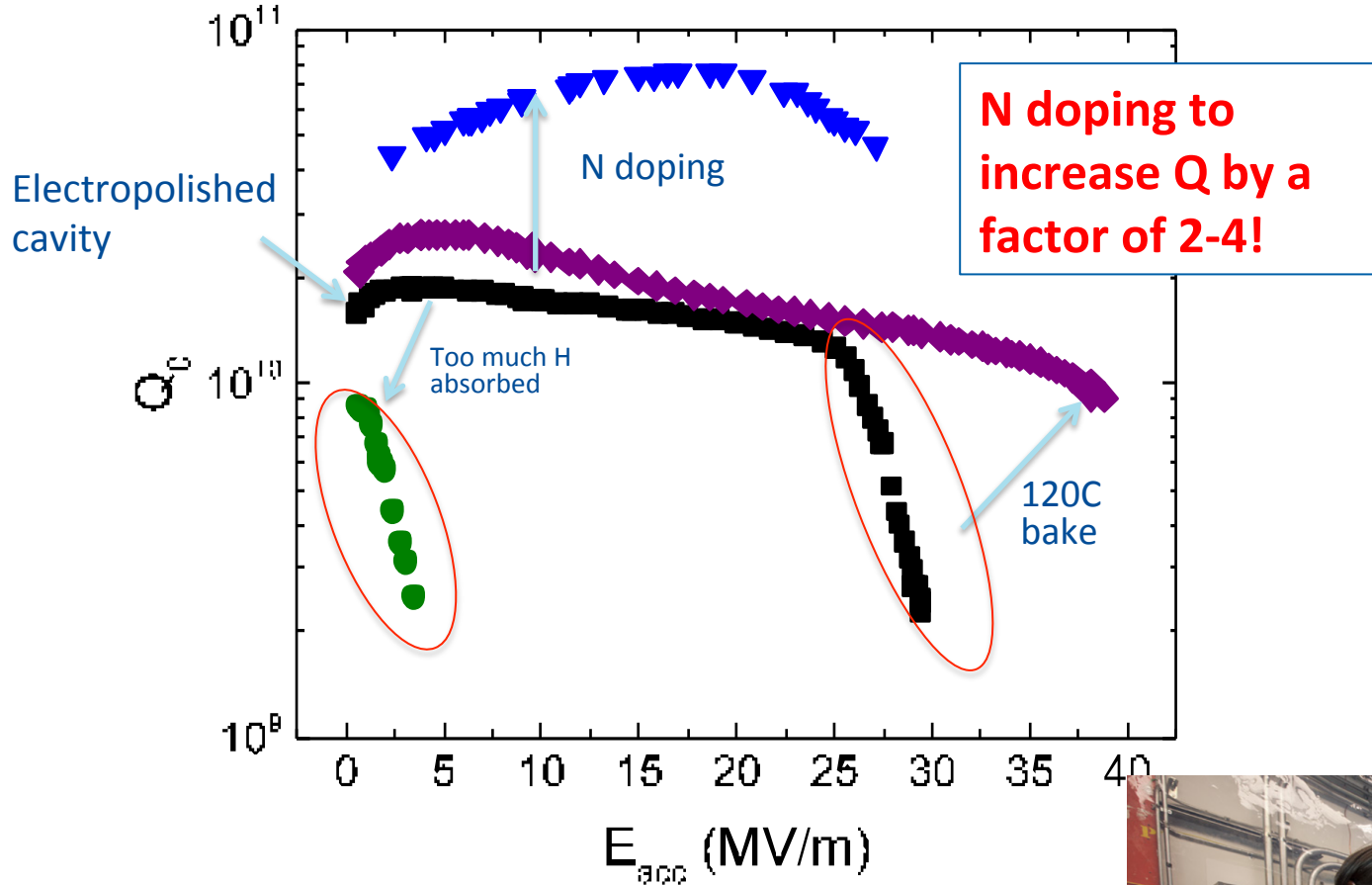

# Illinois Accelerator Research Center (IARC)

---

## Mission

Partner with industry to exploit technology developed in the pursuit of science to create the next generation of industrial accelerators, products, and new applications.



## Vision

IARC will be the preeminent national enabler of accelerator based products and services serving as the seed for industry growth.



## Fermilab strategy: summary

---

- Exploit exciting physics opportunities
- Ensure continued U.S. leadership in LHC program
- Host the world's strongest accelerator-based neutrino program
- Modernize & upgrade accelerator infrastructure & other facilities
- Develop a “commercialization” & social impact component
- Advance core competencies e.g. high-field magnets, SRF
- Continue to work with university community and other labs to plan for longer term future in conjunction with the world